

## ***DELPHYS XL***

High Power UPS from 1 to 4 MW and 1.2 to 4.8 MW



Socomec Resource Center  
To download, brochures, catalogues  
and technical manuals

# CONTENTS

1. WARRANTY CERTIFICATE	4
2. FOREWORD	5
3. GENERAL DESCRIPTION	6
3.1. Safety	7
3.2. Power Supply Inputs	7
4. CONTROL PANEL	8
5. DISPLAY OPERATION	9
5.1. Display description	9
5.1.1. Home page – UPS view	9
5.1.2. MOD view	10
5.1.3. Sys view	10
5.1.4. Units overview (for parallel system)	10
5.2. Menu architecture	11
5.3. Functioning mode	13
5.4. Status	13
5.4.1. Status page	13
5.5. Alarms management	14
5.5.1. Alarm report	14
5.5.2. Alarm popup	14
5.5.3. Alarm page	14
5.6. Synoptic animation	15
5.6.1. Additional icons	22
5.7. Event log page	22
5.8. Menu function descriptions	23
5.8.1. Entering passwords	23
5.8.2. Monitoring menu	23
5.8.3. Events log menu	23
5.8.4. Measurements menu	24
5.8.5. Controls menu	24
5.8.6. UPS configuration menu	24
5.8.7. User parameters menu	24
5.8.8. Service menu	24
5.9. Additional user functions	25
5.9.1. phase color modification	25
6. OPERATING PROCEDURES	26
6.1. Switching on	26
6.2. Bypass operations	26
6.3. Extended out of service	27
6.4. UPS Power OFF	27
7. OPERATING MODES	28
7.1. On line mode	28
7.2. Smart conversion mode (optional)	28
7.3. Operation with maintenance bypass	29
7.4. Operation with motor generator (GENSET)	29
7.5. Multiple communication options	29

<b>8. STANDARD FEATURES AND OPTIONS</b> .....	<b>30</b>
8.1. ADC+SL card .....	31
8.1.1. Temperature sensor .....	32
8.2. Net Vision card .....	33
8.2.1. EMD .....	33
8.3. ACS card .....	33
8.4. Modbus TCP card .....	33
8.5. BACnet card .....	33
8.6. Remote touchscreen display .....	33
<b>9. PREVENTIVE MAINTENANCE</b> .....	<b>34</b>
9.1. Batteries .....	34
9.2. Fans .....	34
9.3. Capacitors .....	34

# 1. WARRANTY CERTIFICATE

The warranty terms and conditions are stipulated in the offer, by default the following clauses apply.

The SOCOMEC warranty is strictly limited to the product(s) and does not extend to equipment which may be integrated with this/these product(s), nor the performance of such equipment.

The manufacturer guarantees its products to be free from manufacturing faults and defects in design, material or workmanship, subject to the limits set forth below.

The manufacturer reserves the right to modify the delivery with a view to fulfilling these guarantees or to replace defective parts. The manufacturer's warranty does not apply in the following cases:

- fault or defect in the design of parts added or supplied by the customer,
- fault due to unforeseen circumstances or force majeure,
- replacement or repair resulting from normal wear and tear of the modules or machinery,
- damage cause by the non-respect of the batteries configuration & back-up time validated by the manufacturer,
- damage caused by negligence, lack of proper maintenance or misuse of the products,
- repair, modification, adjustment or replacement of parts undertaken by unqualified third parties or personnel without the express consent of SOCOMEC .

The warranty period is twelve months commencing from the date of delivery of the product.

The repair, replacement or modification of the parts during the warranty period does not imply or justify any extension of the warranty beyond the original period.

In order to establish a valid warranty claim, the purchaser must notify the manufacturer in writing immediately after the discovery of any apparent material defects and provide any and all supporting evidence of the defects at the latest within eight days before the date of expiry of the warranty.

Defective parts which have been returned and replaced free of charge shall become the property of SOCOMEC .

The warranty is void if the purchaser has undertaken modifications or repairs on the devices on his or her own initiative and without the express consent of the manufacturer.

The manufacturer's responsibility is strictly limited to the obligations defined in this warranty (repair and replacement) excluding any other right to claim compensation or indemnity.

Any import tax, duty, fee or charge of any nature whatsoever imposed by European regulations or those of an importing country or of a transit country shall be paid by the purchaser.

## 2. FOREWORD

We thank you for the trust you have in our Uninterruptible Power Systems DELPHYS XL.

This equipment is fitted with up to date technology. Rectifier and inverter subsets are provided with power semiconductors (IGBT) including a digital micro-controller.

Our equipment complies with standard IEC EN 62040-2 and 62040-1.



**“This is a product for restricted sales distribution to informed partners. Installation restrictions or additional measures may be needed to prevent disturbances”.**

### SAFETY REQUIREMENTS

Using conditions:

Do read carefully these operation instructions before using the UPS and comply with the safety notes mentioned.

Whatever the repairs, they must be made only by authorised staff, who have been suitably trained. It is recommended that the ambient temperature and humidity of the UPS environment are maintained below the values specified by the manufacturer.

This equipment meets the requirements of the European directives applied to this product. As a consequence it is labelled as follows:



### REGULATIONS CONCERNED WITH ENVIRONMENTAL ISSUES

#### **Recycling of electrical products and equipment**

Provision is made in European countries to break up and recycle materials making up the system. The various components must be disposed of in accordance with the legal provisions in force in the country where the system is installed.

#### **Battery wastes**

Used batteries are considered as toxic wastes. It is therefore essential to entrust them solely and exclusively to firms specialised in their recycling. They can not be treated with other industrial or household wastes, as set out in local regulations in force.

### 3. GENERAL DESCRIPTION

Delphys XL is a high performance UPS designed to secure very critical applications and ensure business continuity thanks to a full resilient architecture.

Delivering much more benefits than classical monolithic systems, DELPHYS XL packs 1000 or 1200kW into an overall space-saving design while keeping simplified and flexible integration into your environment.

- FLEXIBLE INTEGRATION with an optimized footprint,
- UNMACHTED RESILIENCY : fault tolerant architecture based on a unique brick concept,
- BEST IN CLASS ENERGY MANAGAMENT for maximum savings,
- EASY AND SAFE MAINTENANCE supporting low MTTR,
- CRITICAL CHAIN interoperability.

Delphys XL can sustain these values thanks to its unique architecture and design:

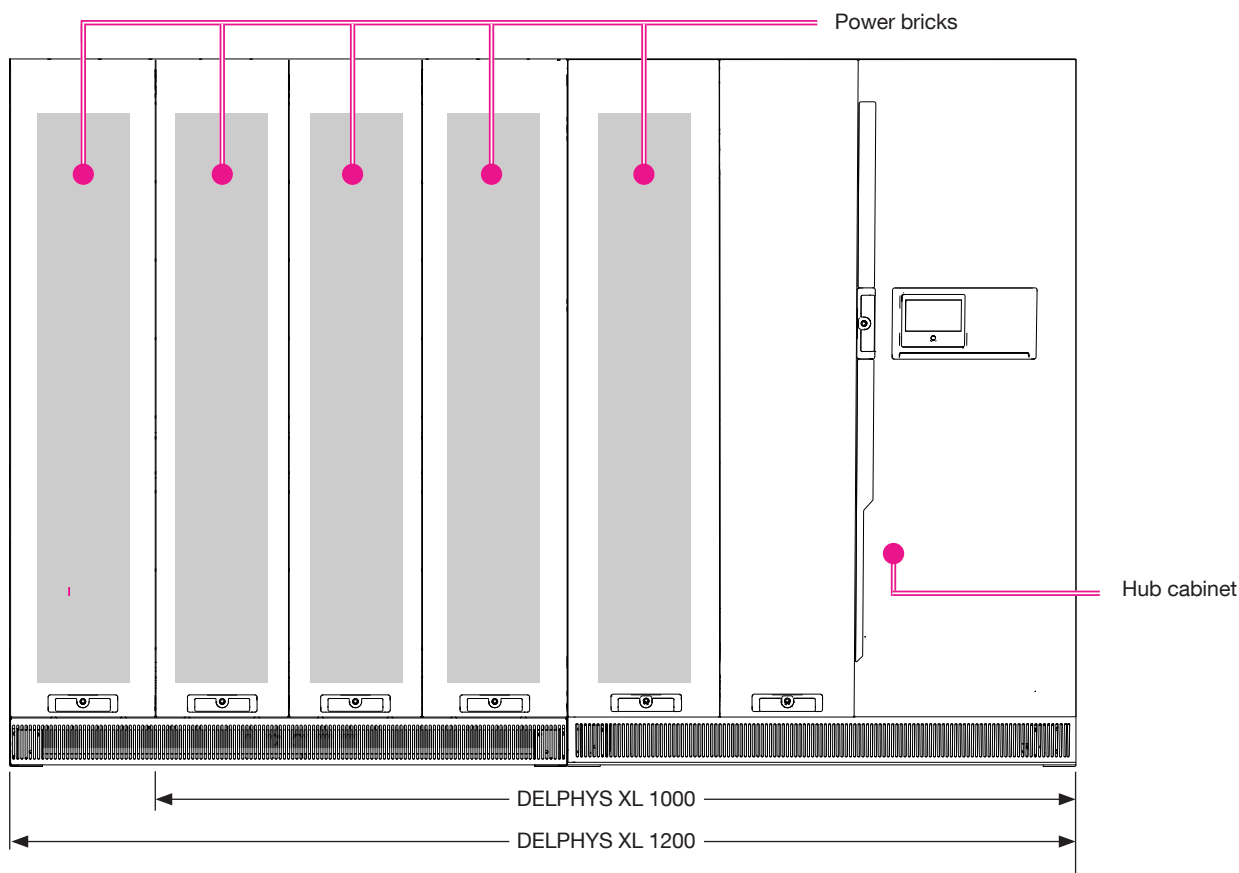

#### Hub cabinet for the UPS UNIT

- All input(s) –outputs and battery connections to the UPS units
- 1 MW/1.2 MW centralized static switch on bypass line, according to the model
- Local users interface (HMI)
- Remote communications interfaces

#### Power bricks rated for 1 MW/1.2 MW continuous operation

- Single and fully rated Rectifier - Inverter & Battery charger per Power Brick
- Highly efficient & reliable Power Bricks
- Selective disconnection to allow electrical isolation of the Power Brick when required

Delphys XL is designed manufactured and tested in France. The development and the production site are certified according to ISO 14001 (Environmental management system) and ISO 9001 (Quality management system).

## 3.1. Safety

### CAUTION

The equipment can only be switched on or used if the following conditions are fulfilled:

- electrical connections comply with the regulation in force (earth bonding, appropriate protections and cross-section of cables),
- all means to comply with the protection index of the system are in place, such as side panels, doors, glands, shields or whatever...

### ADVICE

- Carefully follow the instructions described in this manual,
- All operations must only be carried out by personnel who are suitably trained and with authorized access to restricted areas.

### CAUTION

Do not forget that even when the HMI is OFF the unit may be lived:

- because of the mains voltage, the rectifier and the bypass,
- because of the battery voltage,
- because of the load voltage when the maintenance bypass and the output breaker are closed.

### DANGER

Any operation inside the cabinets is to be completed:

- once the UPS is stopped and no longer live,
- after 5 minutes, the time for the capacitors to discharge.



**The residual voltage of the capacitors may still cause heavy electrical arcs after 5 minutes.**



**Before closing the battery protection, be sure that the rectifier is started !**

### HAZARD INDICATION

While the UPS is operating, this label indicates that the parts are live and therefore the risk of electrical hazard.



**All operations behind protection panels must only be carried out by personnel who are suitably trained.**

## 3.2. Power Supply Inputs

Three power supply inputs are needed to operate the system:

- voltage on input 1 for the supply to the rectifier,
- voltage on input 2 for the supply to the automatic static bypass (depending on the system, inputs 1 and 2 can be common),
- the DC voltage for the battery.

## 4. CONTROL PANEL

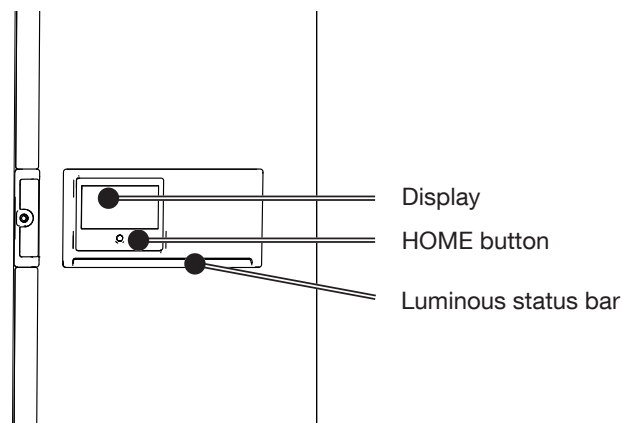

Only two elements are necessary to interact with the unit:

- HOME button: is a mono-stable button used to interact manually with the display especially in emergencies situations. Logic behind the interaction is:
  - Single pressing (below 3 sec): HOME page return of graphic display,
  - 3 sec < time < 6 sec: change the language to the default (English),
  - 6 sec < time < 8/9 sec: go to the calibration screen automatically,
  - Above 8/9 sec: implement the hw reset of the micro controller and restart of the graphic.
- Display: is the main active matrix of the display sensitive to touch pressure. The display is designed for rugged industrial applications. The display is single-touch only (no double touch effects). Depending on pressure, the navigation tree and various functions will be executed.

Two special functions are present on the control panel:

- Standby screen: for safety reasons, after a programmable amount of time, the display goes on standby. Display goes to the main screen and touch screen sensitivity is disabled. A label on the bottom of the main screen displays this status. To exit this status press the screen for the HOME button.
- OFF status: for power consumption and life enhancement, after a programmable amount of time display goes in "off". Display goes black and no interaction is possible. Touching the HOME button or screen resumes normal operations.



**Handle the control panel with care. It is made of metal, glass and plastic and contains delicate electronic components. The control panel may be damaged if dropped, pierced or broken or comes into contact with liquids. Do not use the control panel with a cracked screen, as it may cause injury.**

Control panel luminous status bar indicator	
Colour	Status
Flashing green-yellow-red	No communication. The data is no longer updated or not present. Load status cannot be given
Flashing red	Load supplied, but the output will stop in few minutes
Red	Load not supplied: Output switched OFF due to an alarm
Flashing yellow-red	Load supplied, but no longer protected. A critical alarm occurs
Flashing yellow	Maintenance request / in progress
Yellow	Load supplied with warning
Flashing green-yellow	Load supplied and preventive alarm present
Flashing green	Load going to be supplied and testing
Green	Load protected in inverter
Grey (OFF)	Load not supplied output on standby / isolated / OFF



# 5. DISPLAY OPERATION

## 5.1. Display description

### 5.1.1. Home page – UPS view

Two Home Page are available with Dephys XL

You can select one of them by swiping on the left or on the right when you are on the home page

- Home page basic

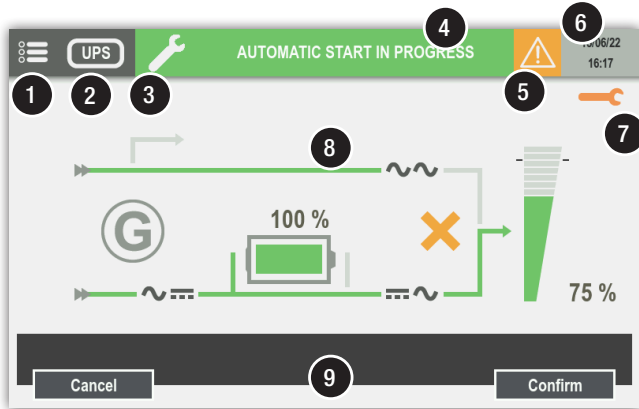

- Home page Single Line Diagram (standard)

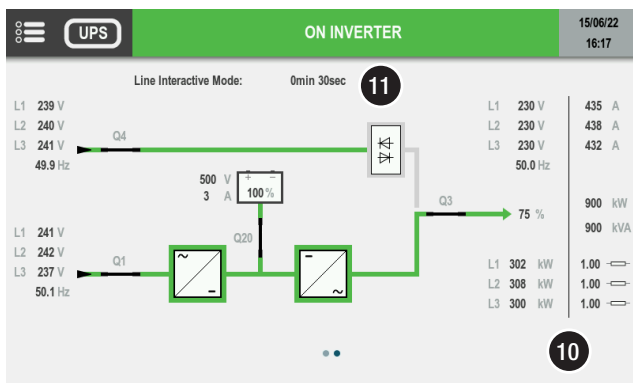

- 1 Menu access
- 2 Device reference
- 3 Functioning mode (see 'Functioning mode' chapter)
- 4 Status displaying / Status page access
- 5 Alarm present – access to alarm page  
“Alarms” icon appears in case of preventive/critical alarm. A dedicated pop-up appears and can be cleared.
- 6 Clock
- 7 Maintenance alert
- 8 Synoptic area: Basic or Single Line diagram
- 9 Help message area  
“Press Key to wake up” appears when the display goes on standby. Touch the display to wake it up.
- 10 Measures
- 11 Timer in Smart Conversion mode

More details are available by clicking on each power subassembly – please refer to the chapter 5.6 SYNOPTIC ANIMATION.

Others view are available by clicking on the device reference according to the configuration.

DEVICE REFERENCE In single unit configuration:

- UPS View : Home page for standalone UPS (as detailed hereabove),
- MOD view : Unit overview of the internal power bricks.

DEVICE REFERENCE In parallel units configuration:

- UPS View : Home page at the unit level (as detailed hereabove),
- MOD view : Unit overview of the internal power bricks,
- SYS view : System view of the several UPS in parallel,
- --- view : Units overview of the internal power bricks for each unit.

## 5.1.2. MOD view

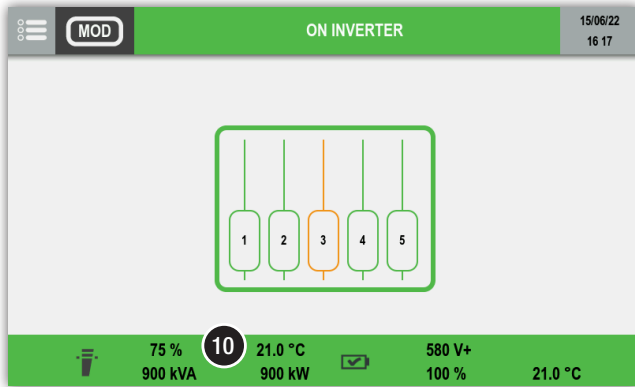

Synoptic area described the internal power bricks state overview:

- Green : No alarm
- Orange : Preventive alarm
- Red : Critical alarm

## 5.1.3. Sys view

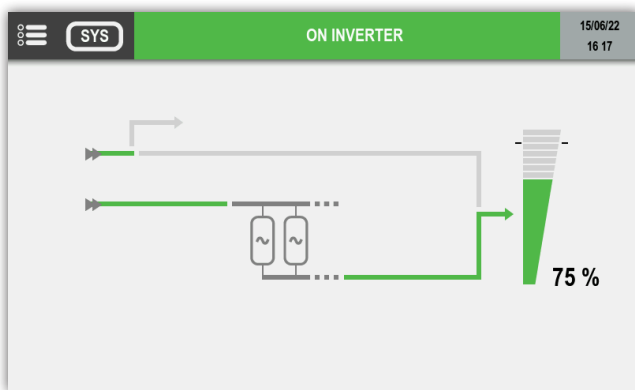

Synoptic area shows each UPS unit and the global system load rate.

## 5.1.4. Units overview (for parallel system)

Units overview of the internal power bricks for each unit.

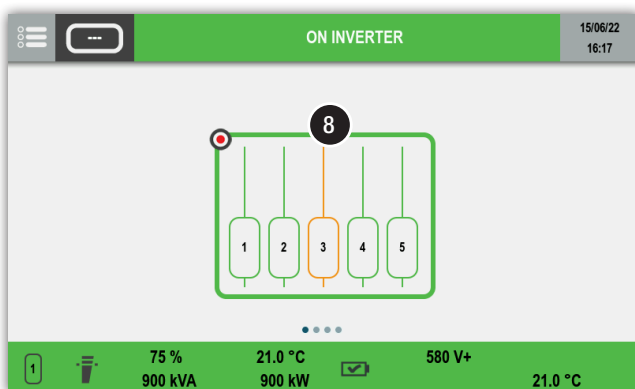

On the units overview, you have the possibility to see the power bricks of the others units by swiping on the left or the right  
- The red circle on the synoptic area (8) indicate on which units you are.

## 5.2. Menu architecture

	MENU ITEMS		
	UPS View [UPS]	Units view [1] to [4]	System view [SYS]
<b>MONITORING</b>			
▶ ALARMS	•	•	•
▶ STATUS	•	•	•
▶ SYNOPTIC	•		
▶ UNIT		•	•
▶ SYSTEM		•	•
▶ MODULES (VIEW---)		•	•
▶ MODULE	•	•	•
<b>EVENTS LOG</b>			
	•	•	•
<b>MEASUREMENTS</b>			
▶ OUTPUT MEASUREMENTS	•	•	•
▶ BATTERY MEASUREMENTS	^	^	^
▶ INPUT MEASUREMENTS	•	•	•
▶ INVERTER MEASUREMENTS	•	•	
▶ BYPASS MEASUREMENTS	^	^	^
<b>CONTROLS</b>			
▶ UPS PROCEDURE			
▶ START	•1		•1
▶ ON MAINTENANCE BYPASS	•1		•1
▶ TRANSFER			
▶ LOAD ON BYPASS	•		•
▶ LOAD ON INVERTER	•		•
▶ MODE			
▶ SMART CONVERSION CONTROLS			
▶ SMART CONVERSION ON	^		^
▶ SMART CONVERSION OFF	^		^
▶ SMART CONVERSION SCHEDULE	^		^
▶ ENERGY SAVER CONTROLS			
▶ ENERGY SAVER ON			^
▶ ENERGY SAVER OFF			^
▶ BATTERY			
▶ BATTERY CONTROLS			
▶ BATTERY TEST	^	^	^
▶ BATTERY SCHEDULE	^	^	^
▶ MAINTENANCE			
▶ Alarms reset	•	•	•
▶ LED test	•	•	•

	MENU ITEMS		
	UPS View [UPS]	Units view [1] to [4]	System view [SYS]
<b>CONFIGURATIONS</b>			
▶ CLOCK	•		•
▶ COM-SLOTS			
▶ COM-SLOT 1		^	
▶ COM-SLOT 2		^	
▶ TEMPERATURE PROBE	^	^	^
▶ REFERENCE			
▶ SOCOMEC REFERENCE	•	•	•
▶ SERIAL NUMBER	•	•	•
▶ USER REFERENCE	•	•	
▶ LOCATION	•	•	
▶ REMOTE			
▶ REMOTE ON	•		•
▶ REMOTE OFF	•		•
<b>USER PARAMETERS</b>			
▶ LANGUAGE	•		•
▶ PASSWORD	•		•
▶ BUZZER	•		•
▶ DISPLAY	•		•
▶ PREFERENCES	•		•
▶ TOUCHSCREEN	•	•	•
<b>SERVICE</b>			
▶ SERVICE REPORT	•	•	
▶ FW VERSION	•	•	
▶ NETWORK PARAMETERS (Only for service)			

(^). Depending on setting

1. Displayed depending on state.

## 5.3. Functioning mode



Service



Isolated



Energy saver active

## 5.4. Status

### 5.4.1. Status page

Status page is accessible by clicking on the top bar.

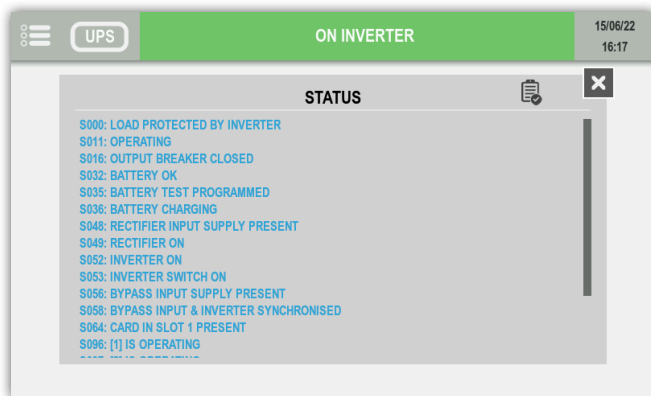

Filtering



List all active status



List all status



List all status not active

## 5.5. Alarms management

### 5.5.1. Alarm report

The alarm icon is present if at least one alarm is present.

Tap on the icon  to open the alarm list.

### 5.5.2. Alarm popup

In case of critical alarm a popup message appears and the buzzer is running according its settings.

The highest priority alarm is displayed.

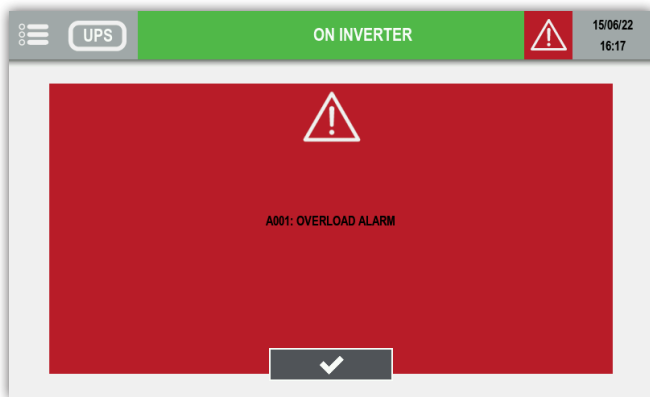

Tap on valid button to stop the buzzer and to close the popup message. Tap on warning symbol to see alarm page.

### 5.5.3. Alarm page

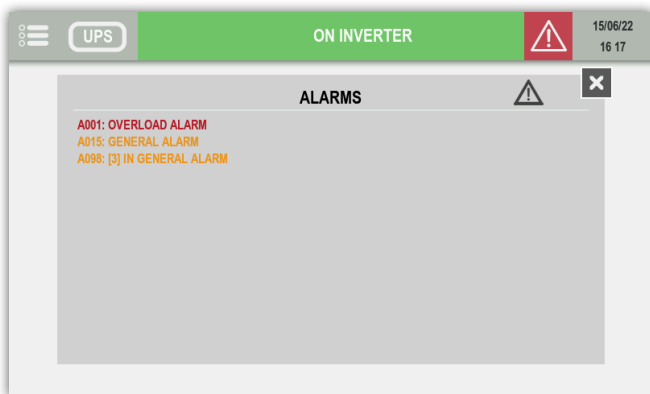

#### Filtering



List all active alarms



List all active preventive alarms



List all active critical alarms

#### Popup alarm for preventive alarm

In USER PARAMETERS menu, PREFERENCES item gives the possibility to enable popup alarm also with preventive alarms.

## 5.6. Synoptic animation

- UPS view
  - Basic view

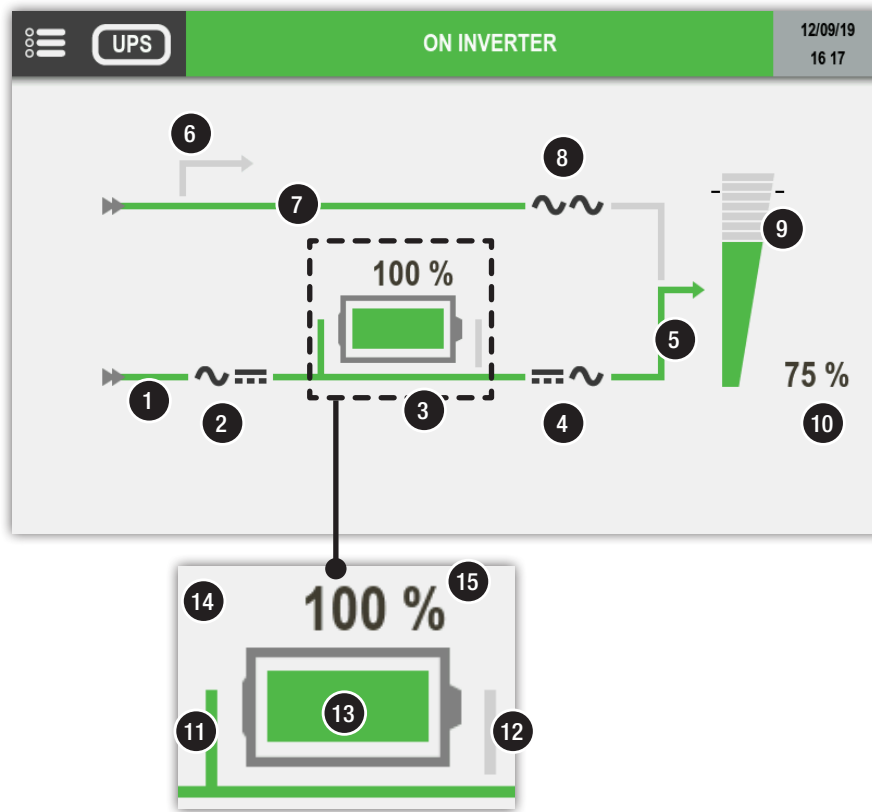



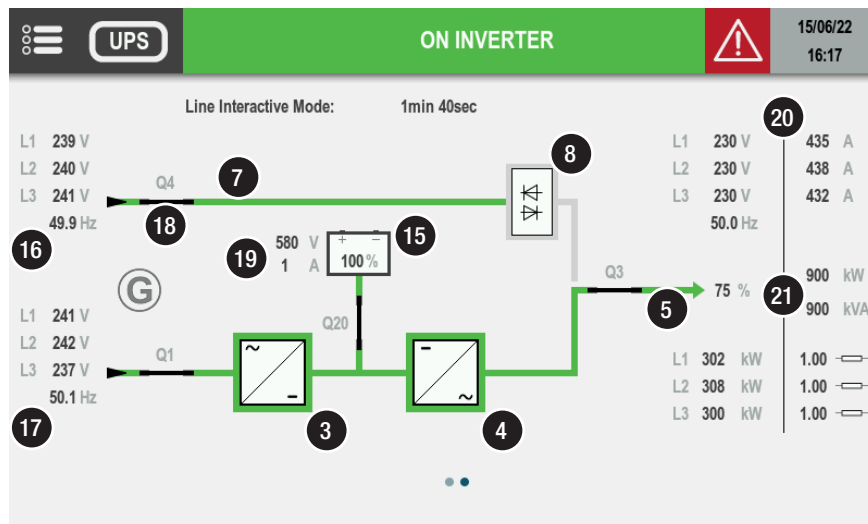



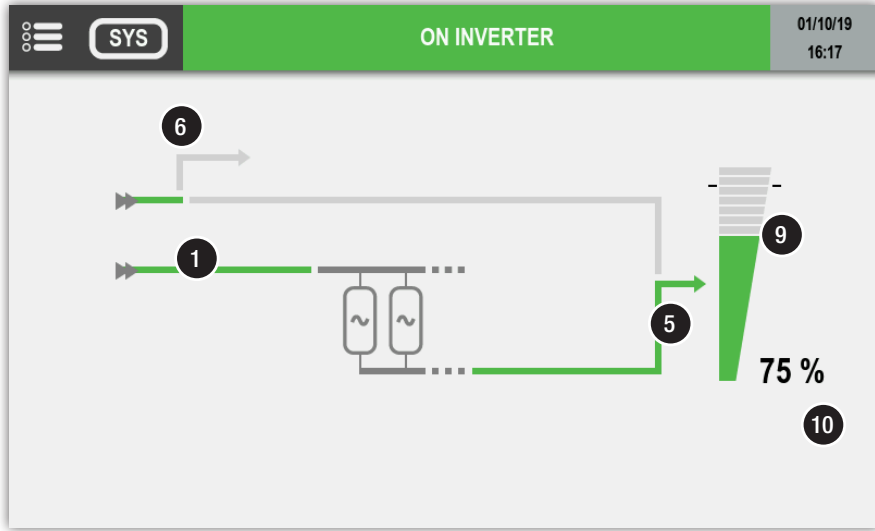











- Single line diagram view



- Parallel system: System view





Item	Description	Rules of animation				Touch actions
		Grey	Green	Yellow	Red	
1	Rectifier input supply	Not present	Present	Out of tolerance	-	-
2	Rectifier status	Normal status	-	Preventive alarm	Critical alarm	Access to input measurements page
						
3	DC voltage bus	DC voltage absent	DC voltage presence	-	-	-
4	Inverter status	Normal status	-	Preventive alarm	Critical alarm	Access to inverter measurements page
						
5	Inverter output	Inverter OFF	Inverter ON	Inverter on battery	-	-
6	Maintenance bypass *	MBP present	-	Load on maintenance bypass	-	-
7	Bypass input *	Not present or Out of tolerance	Present	Load on bypass	-	-
8	Bypass status *	Normal status	-	Preventive alarm	Critical alarm	Access to bypass page
						
9	Load rate symbol	No load	Fill-up to 95%	Fill-up to 110%	Fill-up over 110%	Access to output measurements pages
						
10	Load rate value	Instantaneous value. displayed if value > 0				-
11	DC battery input **	DC voltage absent	DC voltage presence	BCR function running	-	-
12	DC battery output **	DC voltage absent	DC voltage presence	Inverter on battery	-	-
13	Battery indicator **	-	Fill-up to 100%	Fill-up to 45%	Fill-up to 15%	Access to bat. measurements page
						
14	Battery charging / discharging **	-	Battery charging	Battery discharging	-	-
						
15	Battery level or remaining backup time during battery discharge **	Instantaneous value. displayed if value > 0 The backup time is no more displayed if it is below two minutes.				-
16	Input bypass network measurement (L1 L2 L3 Freq)					-
17	Input rectifier network measurement (L1 L2 L3 Freq)					
18	Breaker status					
19	Voltage and current battery measurement					
20	Output measurement (Voltage, Current, Power and cos phi per phase)					
21	Load rate and Active and apparent power					

\* Element disappears if converter mode is active

\*\* Not present if batteries are not present

- Mod view or units view for parallel system

Power bricks overview per unit

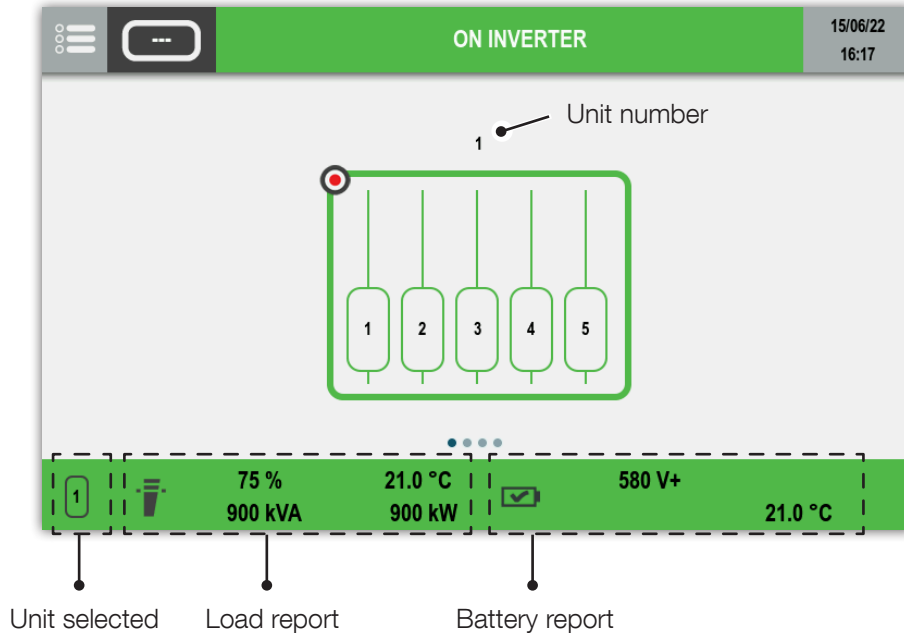

• Battery animation

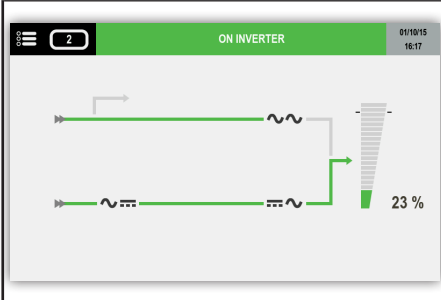
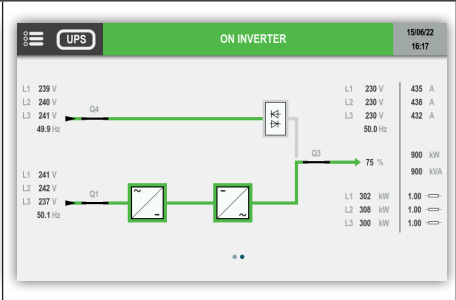
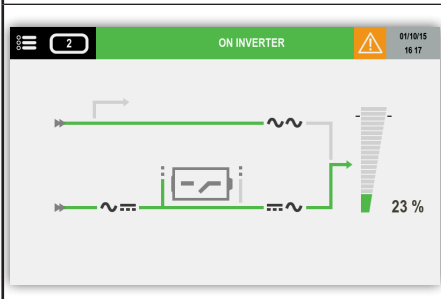
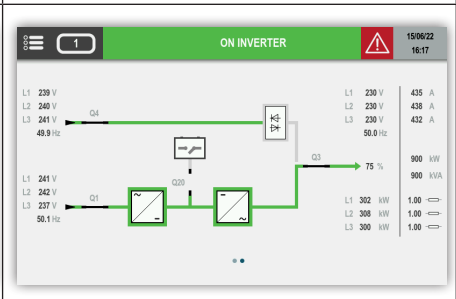
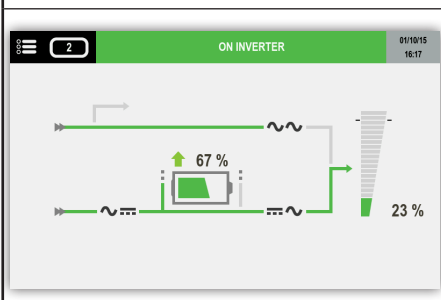
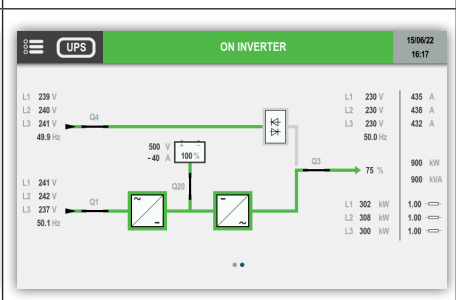
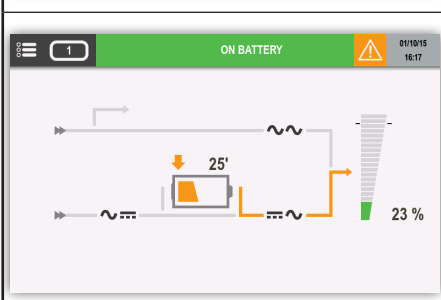
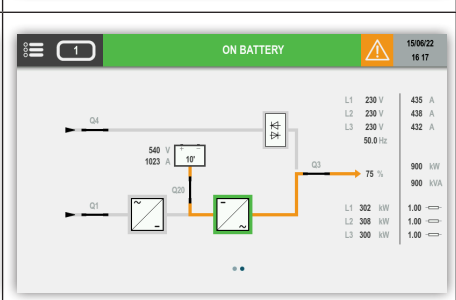
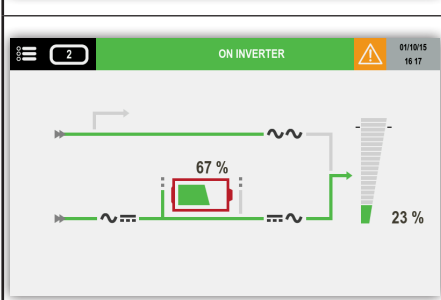
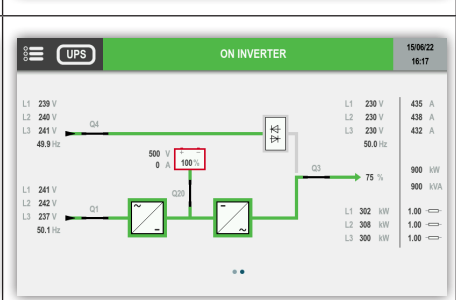
Home page basic	Home page Single Line Diagram	Description
		<p>If battery is set absent, the battery icon is not displayed</p>
		<p>If battery is present but not connected, the icon is displayed</p>
		<p>If the battery is present and charging, the arrow icon is displayed (up 95%)</p>
		<p>If the battery is present and discharging, the arrow icon is displayed</p>
		<p>If a battery alarm has occurred, the yellow or red icon is displayed, depending on the alarm</p>

• Smart conversion mode

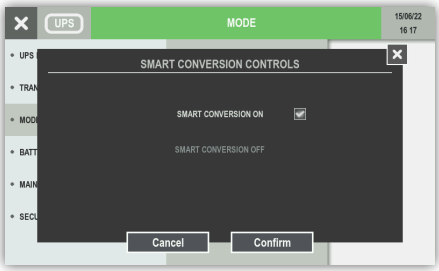
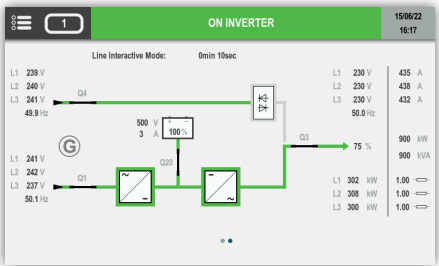
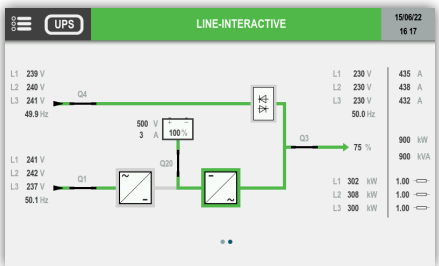
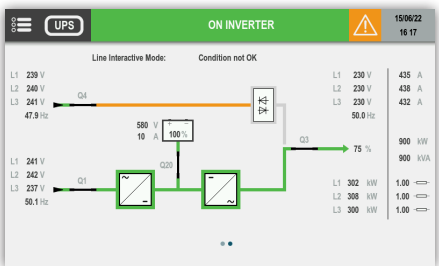
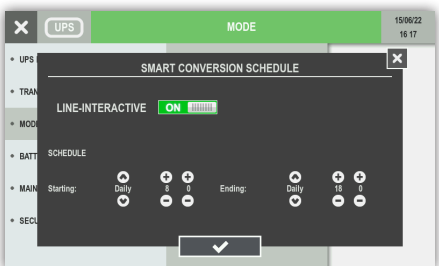
Home page Single Line Diagram	Description
	<p>SMART CONVERSION Mode menu</p> <p>Selection mode SMART CONVERSION ON</p>
	<p>SMART CONVERSION MODE ACTIVATED</p> <p>Timer is decreasing when the network is inside specific tolerances</p>
	<p>Mode Line interactive ON</p> <p>(Bypass as a main source while inverters are ON as active filters)</p>
	<p>Mode Line interactive OFF</p> <p>CONDITIONS NOT OK</p> <p>Mode line interactive in standby waiting for the network quality (ex : input frequency out of tolerance)</p>
	<p>Smart conversion scheduling menu to activate the mode within a specific time slot</p>

• Energy Saver mode

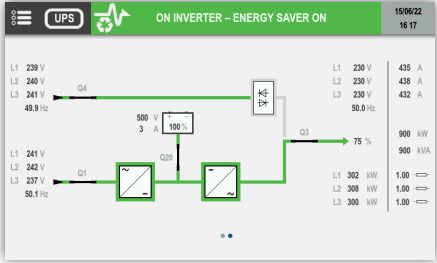
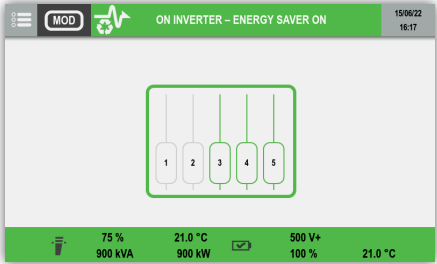
Home page Single Line Diagram	Description
	<p>Energy SAVER mode menu</p> <p>Selection ENERGY SAVER ON feature (in VFI mode)</p>
	<p>Energy SAVER ON activated</p>
	<p>Energy SAVER ON activated</p> <p>Modules view : 2 modules in hot standby</p>

• Battery capacity test

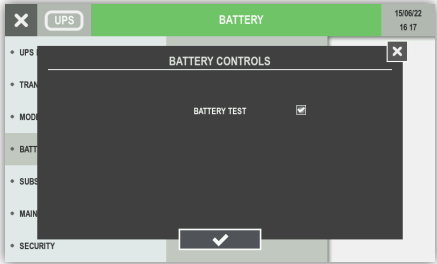
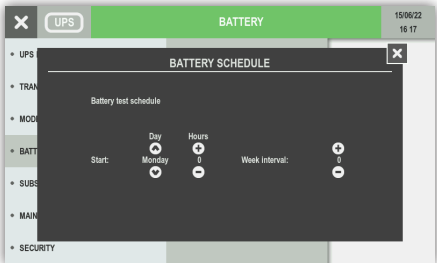
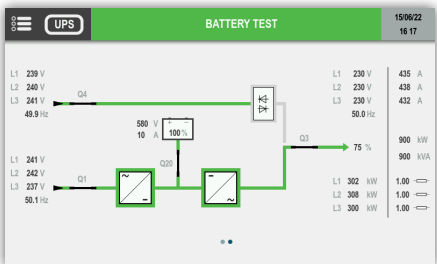
Home page Single Line Diagram	Description
	<p>Battery capacitive test menu</p> <p>Selection Batterie capacitive test ON</p>
	<p>Battery capacitive scheduling menu</p>
	<p>Battery capacitive test ongoing</p>

## 5.6.1. Additional icons



Bypass impossible



Bypass locked



“Genset Mode” when the gen set contact is active. Need ADC+SL.



Maintenance alarm.

Preventive maintenance is requested.

## 5.7. Event log page

Date	Time	Code	Description	Status
13/09/19	08:30:00	S000	LOAD PROTECTED BY INVERTER	YES
13/12/19	08:30:00	S012	AVAILABLE	YES
13/12/19	08:30:00	A032	RECTIFIER CRITICAL ALARM	NO
13/12/19	08:30:00	A015	GENERAL ALARM	NO
13/12/19	08:30:00	A034	RECTIFIER REDUNDANCY ALARM	NO
13/12/19	08:30:00	S058	BYPASS INPUT & INVERTER SYNCHRONISED	YES
20/11/19	04:00:00	C028	Battery test	



Show STATUS events



Show ALARMS events



Show CONTROLS

## 5.8. Menu function descriptions

Menu is available only in "UPS" device reference view.

### 5.8.1. Entering passwords

Some operations and settings require a password in order to be performed.

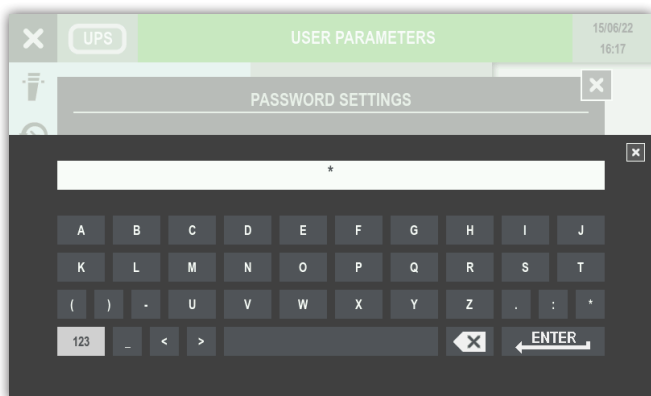
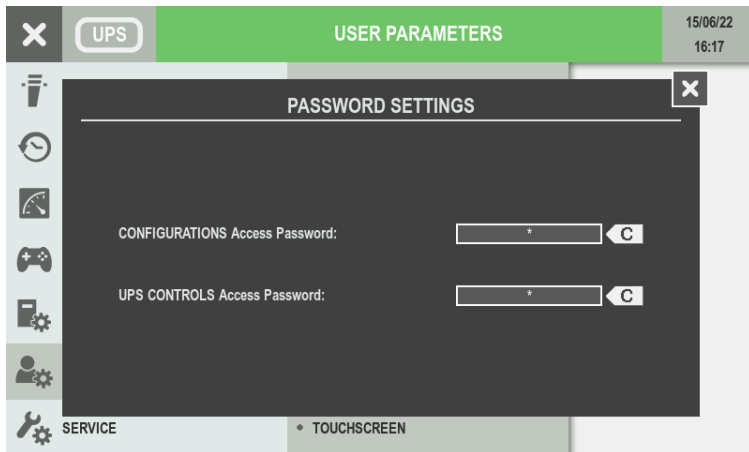

Press "123" to cycle to number view page.

Press ENTER to confirm.

Wildcard covering of the password is active by default.

Press **ENTER** to confirm the selection or **HOME BUTTON** to abort.

### 5.8.2. Monitoring menu

Submenu Alarm opens the alarm pages.

Submenu Status opens the status pages.

### 5.8.3. Events log menu

This menu accesses the event log (Status and Alarms).

## 5.8.4. Measurements menu

This menu displays all UPS measurements relating to the rectifier input stage, output stage, batteries, bypass input stage and inverter.

The pins on the bottom of the screen indicate whether or not there are more pages. Sliding to the right or left changes measurements page.

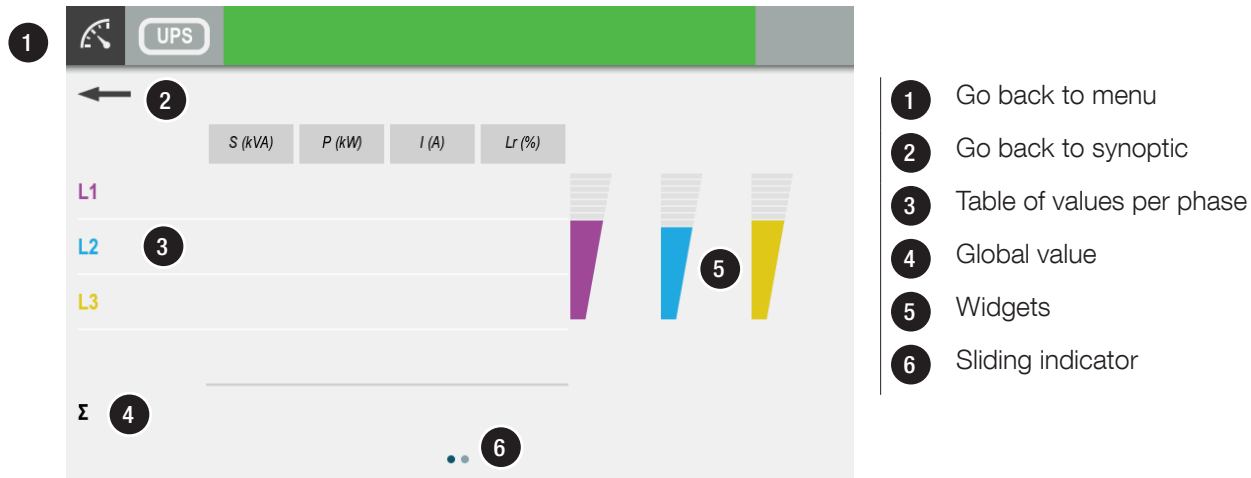

## 5.8.5. Controls menu

This menu contains the commands that can be sent to the UPS. Some of them are password protected. If a command is not available, a COMMAND FAILURE message appears.

- UPS PROCEDURE: START/ON MAINTENANCE BYPASS see 'Operating procedures' chapter,
- TRANSFER: transfer LOAD ON BYPASS, transfer LOAD ON INVERTER,
- BATTERY: BATTERY CONTROLS > BATTERY TEST: this function checks whether or not test conditions are available and returns the results,
- MODE: SMART CONVERSION CONTROLS: ON/OFF,
- SMART CONVERSION SCHEDULE: this function schedules the smart conversion mode (Start date - End date),
- MODE : ENERGY SAVER CONTROLS: ON/OFF,
- MAINTENANCE: Alarms reset: this function clears the alarm history, LED test: this function activates LED flashing for a few seconds.

## 5.8.6. UPS configuration menu

- CLOCK: this function sets the date and time,
- COM-SLOTS: this function configures the RS485 modbus serial link,
- REFERENCE: this function gives the possibility to customised the unit reference and the location,
- REMOTE: this function enables controls from remote devices through MODBUS protocol (NET VISION for example).

## 5.8.7. User parameters menu

This menu contains the different functions for users such as language, password, buzzer, display, preferences, touchscreen calibration.

## 5.8.8. Service menu

This menu is reserved for support service personnel and holds UPS identification data and utilities for software upgrades.







## 5.9. Additional user functions

### 5.9.1. phase color modification

- Enter **MAIN MENU > USER PARAMETERS > PREFERENCES.**

For each phase is possible to select a specific colour in a set of colour range. Those colours are applying in the measurements pages.

Colour	Default colour
 Yellow	Phase 3
 Orange	
 Red	
 Green	
 Light blue	Phase 2
 Dark blue	
 Purple	Phase 1
 Brown	
 Light grey	
 Dark grey	
 Black	

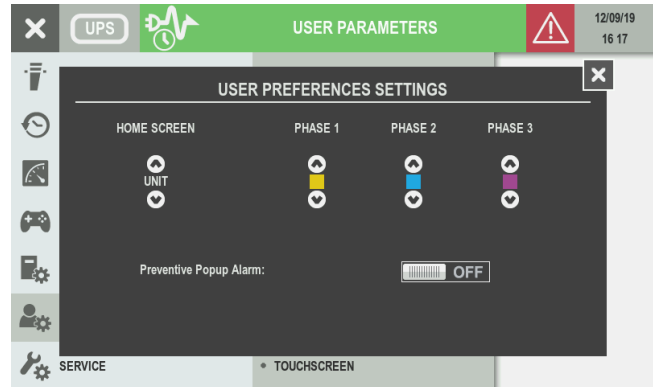

The popup alarm appears in case of critical alarms. This function can be extended to preventive alarms by switching “Preventive Popup Alarm” to ON.

## 6. OPERATING PROCEDURES

 **NOTE:** before carrying out any operations on the unit read the 'Safety standards' chapter carefully.

 **NOTE:** letters refer to the diagram in 'System overview' chapter.

### 6.1. Switching on

- Connect the input and auxiliary mains to the coupling (**A** and **B**),
- Wait until the displays switch on,
- Enter **MAIN MENU > CONTROLS > UPS PROCEDURE**,
- Select **START** and press **ENTER**,
- Carry out the operations indicated on the display.

 **NOTE:** In case some switches are not present on the site, please press Ok and move to the next operation.

### 6.2. Bypass operations

#### Switching onto maintenance bypass

This operation creates a direct connection between the UPS input and output, excluding the equipment control part. This operation is performed in the event of:

- Standard maintenance,
- Serious failure has occurred.

 **WARNING! LOAD POWERED BY INPUT MAINS!**  
Your load is exposed to mains disturbances.

- Enter menu **MAIN MENU > CONTROLS > UPS PROCEDURE**,
- Select **ON MAINTENANCE BYPASS** and press **ENTER**,
- Carry out the operations indicated on the display,
- Proceed to maintenance operations.

#### Switching on from maintenance bypass

- Connect the input mains to the coupling (**A** and **B**),
- Wait for the display to switch on,
- Enter menu **MAIN MENU > CONTROLS > UPS PROCEDURE**,
- Select **START** and press **ENTER**,
- Carry out the operations indicated on the display.

## 6.3. Extended out of service

When the UPS is deactivated for some time, the batteries must be recharged regularly.

They have to be recharged every three months.

- Connect the input and auxiliary mains to the Power HUB (refer to installation manual),
- Wait for the display to switch on,
- Wait until the power module started (rectifier ON) and close Q200 of this power module,
- Wait until the batteries are fully charged. Check in the menu **MAIN MENU > MEASUREMENTS > BATTERY MEASUREMENTS**,
- Open the external battery breaker/fuses,
- Disconnect the input and auxiliary mains to the Power HUB (refer to installation manual).

## 6.4. UPS Power OFF



**NOTE: This operations interrupts the supply to the output load from both inverters and automatic bypass. Please note that the battery cabinet may still be connected.**

UPS POWER OFF is desactivated as standard configuration – In case of customer request, this option may be available to switch off the unit. In case of battery tripping option, UPS POWER OFF trips the batteries protection.

### REMOTE UPS POWER OFF

If an external main switch is present, it is possible to interrupt the power supply (UPS LOAD OFF) to the output load using the ADC+SL board. Refer to 'Standard features and options' chapter.

# 7. OPERATING MODES

## 7.1. On line mode

A special feature of the UPS is the ONLINE double conversion in conjunction with low distortion mains power absorption. In ON LINE mode, the UPS can supply a voltage that is fully stabilised in frequency and amplitude, regardless of any interference in the mains power supply, within the most stringent classification of UPS regulations.

ONLINE operation provides three operating modes according to mains and load conditions:

- Inverter mode

This is the most frequent operating condition: energy is drawn from the primary mains power supply and converted and used by the inverter to generate the output voltage to power the connected loads.

The inverter is constantly synchronised in frequency with the auxiliary mains to enable load transfer (due to an overload or inverter shutdown) without any break in the power supply to the load.

The battery charger supplies the energy required to maintain or recharge the battery.

- Bypass mode

In the event of inverter failure, the load is automatically transferred onto the auxiliary mains without any interruption in the power supply.

This procedure may occur in the following situations:

- in the event of a temporary overload, the inverter continues to power the load. If the condition persists, the UPS output is switched on to the auxiliary mains via automatic bypass. Normal operation, which is from the inverter, returns automatically a few seconds after the overload disappears.
- when the voltage generated by the inverter goes outside the limits due to a major overload or a fault on the inverter.
- when the internal temperature exceeds the maximum value allowed.

- Battery mode

In the event of a mains failure (micro interruptions or extended power cuts), the UPS continues to power the load using the energy stored in the battery.

- Energy saver mode

When Energy Saver mode is enabled, this mode analyses the load and switches the non-necessary Power bricks to hot stand-by mode. The low consumption of the converters in "hot stand by" and the optimal load rate on the remaining bricks results to higher overall system efficiency.

The bricks operating in online or hot standby mode will be automatically defined by the system to ensure the battery charge and homogenous lifetime of the different converters.

## 7.2. Smart conversion mode (optional)

This operating mode offers a perfect trade-off between high power quality and best efficiencies up to 99% at 1.2MW - reducing your TCO without exposing the critical load to the grid disturbances. In this mode, a specific algorithm monitors in real time the network quality and selects the optimum working mode between Double Conversion (VFI) and Line Interactive (LI).

Line interactive working mode combines the high efficiency of the static bypass as a main source, in parallel with the inverter working as an active filter able to compensate the load reactive power and harmonics.

In case of any abnormal event on the electrical network, the UPS instantaneously transfers to VFI mode to ensure the critical load protection, without any interruption due to the transfer (Class 1 according to 62040-3).

### 7.3. Operation with maintenance bypass

If the internal maintenance bypass is activated using the appropriate procedure, the load is powered directly from the maintenance bypass, while the UPS is separate from the power supply and can be switched off.

This operating mode can be selected for maintenance to be carried out on the system, so that the necessary actions can be performed by service personnel without having to disconnect the power supply to the load.

### 7.4. Operation with motor generator (GENSET)

The UPS can be operated in conjunction with a generator (GENSET) over the ADC+SL card (refer to 'Standard features and options' chapter). With a generator, the frequency and voltage ranges of the auxiliary mains can be increased to accept the instability of the GENSET and at the same time to avoid operation from the battery or risks of out-of-synchronisation switching on to the bypass.

Several functionalities are available in Genset mode:

- Charging current: settable value from 0A to max charging current,
- Power walk in: Settable power ramp (kW/s) when the Genset supplies the UPS for the first time,
- Advanced Genset Management: Real time monitoring of the Genset stability. If required, the UPS algorithm automatically adjusts the UPS power consumption in order to support the genset in case of under frequency.

### 7.5. Multiple communication options

The DELPHYS XL UPS can manage various serial, contact and Ethernet communication channels at the same time. The 2 communication slots available allow the use of signalling accessories and cards.

Each communication channel is independent; simultaneous connections can thus be made to have various levels of remote signalling and monitoring (see the § "options" for a detailed evaluation of the functionality of the cards that can be installed in the slot).

The table below shows the possible connections between the UPS communication channels and the external devices.

<i>Possible options</i>	Optional			
	slot 1	slot 2	slot 1-Ext	slot 2-Ext
ADC + Serial Link interface	•	•	a	b
NetVision	•	•	a	b
Modbus TCP	•	•	a	b
BACnet	•	•	a	b
External gateway for LIB	•	•		







a: possible only if slot 1 is equipped with an ADC + Serial Link interface.

b: possible only if slot 2 is equipped with an ADC + Serial Link interface.

for localisation, please see in the Installation manual the § "Identifying switching and connection organs".

## 8. STANDARD FEATURES AND OPTIONS

Availability	
●	Factory-installed option
○	Available as option
–	Not available

Features	DELPHYS XL	Compatibility
<b>Communication Option</b>		
ADC+SL card (in option)	○	
Temperature sensor	○	  ADC+SL card
Net Vision card	○	
EMD	○	  Net Vision card
ACS card	○●	
Modbus TCP card	○	
BACnet card	○	
Remote touchscreen display	○	  ADC+SL card

 Required option

 Incompatible option

For electrical and mechanical option, please contact SOCOMEC

## 8.1. ADC+SL card

The ADC+SL (Advanced Dry Contact + Serial Link) is a slot optional board that provides:

- 4 relays for external device activation (can be set as normally closed or normally open).
- 3 free inputs to report external contacts to UPS.
- 1 connector for external battery temperature sensor (optional).
- RS485 insulated serial link providing MODBUS RTU protocol.
- 2 LEDs indicating board status.

The board is plug&play: the UPS is able to recognise its presence and configuration (up to 4 standard operating modes can be selected by the display) and manages the ADC+SL outputs and the inputs accordingly. It is possible to create a custom operation mode through after sales service.

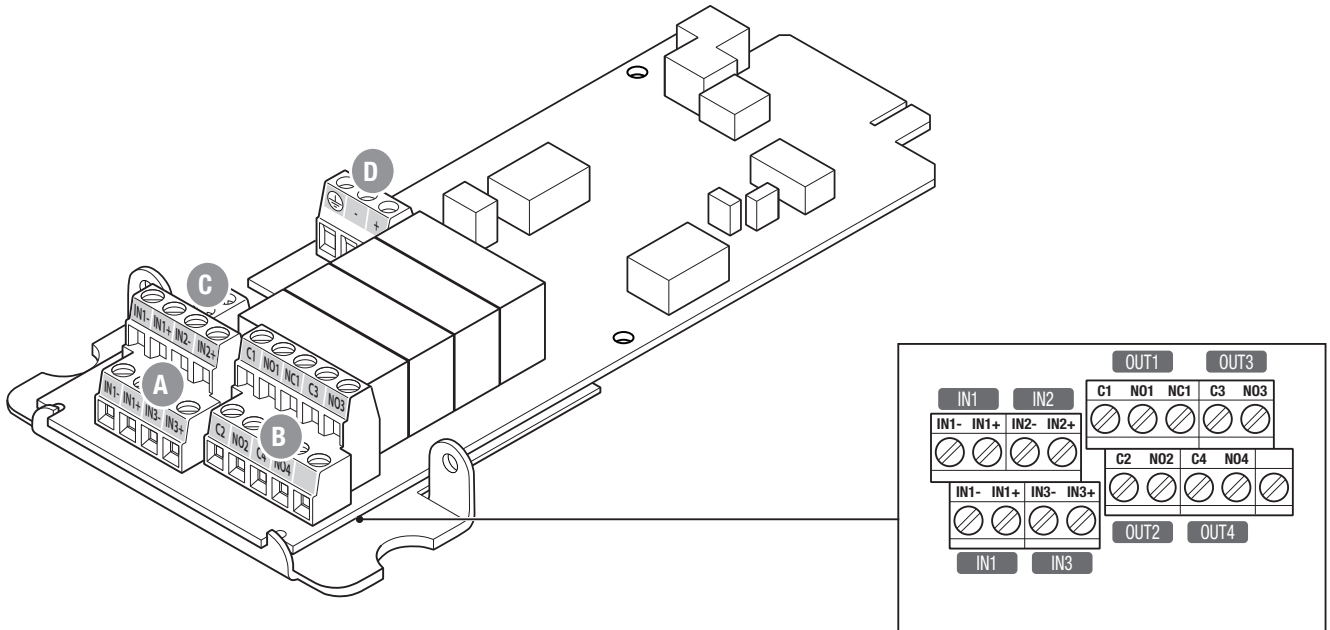

### KEY

- A 3 free inputs to link external contacts to UPS.
- B 4 relays for external device activation.
- C 1 connector for external temperature sensor.
- D RS485 insulated serial link.



**NOTE:** If the board is removed while operating, an alarm is flagged on the control panel. Perform an “Alarm reset” control to cancel it.

### Input

- Free voltage loop.
- INx+ has to be connected to INx- to close the loop on XB4 connector.
- Inputs must be isolated with basic insulation from a primary circuit up to 277 V.
- IN1 is duplicated, giving the possibility to link the UPS POWER OFF signal to other equipment, for example.

### Relay outputs

- Contact voltage guaranteed at 277 V (AC) / 25 V (DC) – 4 A (for higher voltage, please contact the manufacturer).
- Relay 1 gives the possibility of choosing between normally closed (NC1) or normally open (NO1) position. Relays 2, 3 and 4 only have normally open position (NOx).
- On connector XB3, Cx means common, NOx means normally open position.

### Rs485 serial link

- Insulated RS485, protected against over voltage. Only for local bus purposes; maximum ~500 m.
- Pull up and pull down line resistor XJ1 (failsafe biasing): jumper open by default.
- Possibility of fixing the RS485 cable to the board.
- Cable type required: twister pair cable + shield to connect to ground. (AWG 24, 0.2 mm<sup>2</sup> for example).

The INPUT and RELAYS are managed with information coming from the UPS.



**NOTE: Inputs and relays can be re-programmed depending on requirements. Contact your SOCOMEC after-sales service to change Input/Output programming.**

Information coming from inputs can be reported in the UPS database for display on the mimic panel and is accessible on the MODBUS table.

The UPS can manage up to two ADC+SL option cards. The cards can be re-programmed for other uses.

In this specific case, the 2 serial links (SLOT 1 and SLOT 2) are independent.

### Modbus serial link

The RS485 provides MODBUS RTU protocol.

The description of MODBUS addresses and UPS database are described in the MODBUS user manual. All manuals are available on SOCOMEC's web site ([www.socomec.com](http://www.socomec.com)).

### Serial link settings

COM1 relates to serial port on board in SLOT 1.

COM2 relates to serial port on board in SLOT 2.

Settings are available via the mimic panel to configure:

- Baud rate: 2400, 9600, 19200.
- Parity: None, Even, Odd.
- MODBUS slave number: 1 to 32.

### Board status

Board presence is reported through status S064 for slot 1 and S065 for slot 2.

In the case of board failure, 'Option board alarm' (A062) occurs to prevent malfunctioning.

#### 8.1.1. Temperature sensor

The temperature sensor can be used to monitor the battery temperature.

The ADC+SL card can be ordered with or without the temperature sensor in kit.

If the sensor is present, temperature values are available on MODBUS protocol at following addresses:

Temperature board		
Slot 1	0xn0AF(1)	Format ##
Slot 2	0xn0AE(1)	Format ##

1. *n* = unit number

Temperature range: 0 °C to 55 °C.



## 8.2. Net Vision card

NET VISION is a communication and management interface designed for business networks. The UPS behaves exactly like a networked peripheral, it can be managed remotely, and allows the shutdown of network workstations.

NET VISION allows a direct interface between the UPS and LAN network avoiding dependence on the server and support SMTP, SNMP, DHCP and many other protocols. It interacts via the web browser.

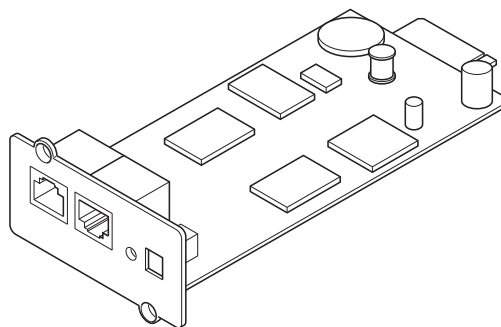

### 8.2.1. EMD

EMD (Environmental Monitoring Device) is a device to be used in conjunction with the NET VISION interface and provides the following features:

- temperature and humidity measurements + dry contact inputs,
- alarm thresholds configurable via Web browser,
- notification of environmental alarm via email and SNMP traps.

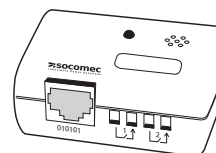

## 8.3. ACS card

ACS (Automatic Cross Synchronisation) card is used to receive a synchronisation signal from an external source and manage it for the UPS where it is installed, and provide a synchronising signal, where requested, to another UPS.

## 8.4. Modbus TCP card

With the MODBUS TCP card fitted in the options slot, the UPS can be monitored from remote stations using the appropriate protocol (MODBUS TCP - IDA).

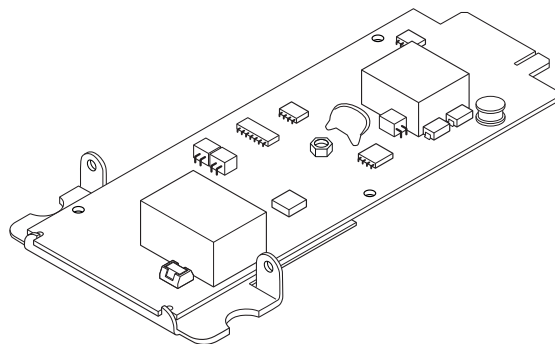

## 8.5. BACnet card

With the BACnet card fitted in the options slot, the UPS can be monitored from remote stations using the appropriate protocol (BACnet).

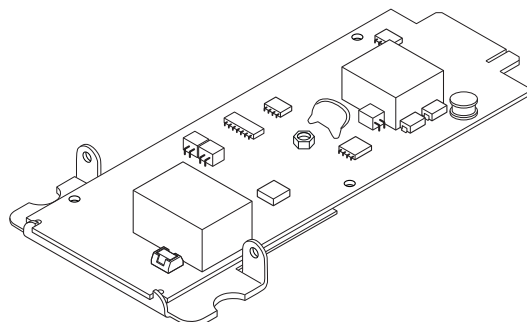

## 8.6. Remote touchscreen display

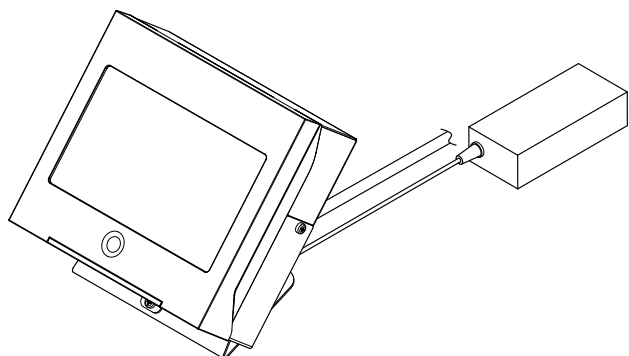

**NOTE!**  
Available only with ADC+SL option card.

## 9. PREVENTIVE MAINTENANCE



**All operations on the equipment must be carried out solely by Socomec personnel or by authorised service personnel.**

Maintenance requires accurate functionality checks of the various electronic and mechanical parts and, if necessary, the replacement of parts subject to wear and tear (batteries, fans and capacitors). It is recommended to carry out periodic specialised maintenance (annually), in order to keep the equipment at the maximum level of efficiency and to avoid the installation being out of service with possible damage/risks. Moreover, attention should be paid to any requests for preventive maintenance that the equipment may automatically display with alarm/warning message.

### 9.1. Batteries

The state of the battery is fundamental to UPS operation.

Thanks to the Expert Battery System, the information relating to the state and the conditions of use of the battery are processed in real time. The recharging and discharging procedures are selected automatically in order to optimise battery life expectancy and offer maximum performance.

Since the expected life of the batteries is very much dependent on operating conditions (number of charging and discharging cycles, load rate, temperature), a periodic check by authorised personnel is recommended.



**When replacing the batteries, use the same type and configuration by placing them in the appropriate containers so as to avoid the risk of acid leakage.**



**The replaced batteries must be disposed of at authorised recycling and disposal centres.**



**Do not open the plastic cover of the batteries as they contain harmful substances.**

### 9.2. Fans

The life of the fans used to cool the power parts is dependent on the using and environmental conditions (temperature, dust). Preventive replacement by an authorised technician is recommended within 7 years (in normal operating conditions).



**When needed, fans must be replaced as per specifications by Socomec.**

### 9.3. Capacitors

The equipment houses electrolytic capacitors (used in the rectifier and inverter section) and filtering capacitors (used in the output section), whose life is dependent on using and environmental conditions.

The average expected life of these components is shown below:

- electrolytic capacitors: 7 years,
- filtering capacitors: 7 years.

In any case the effective state of the components is verified during preventive maintenance.



# Socomec: our innovations supporting your energy performance

**1** independent manufacturer

**3,600** employees  
worldwide

**10** % of sales revenue  
dedicated to R&D

**400** experts  
dedicated to service provision

## Your power management expert



POWER  
SWITCHING



POWER  
MONITORING



POWER  
CONVERSION



ENERGY  
STORAGE



EXPERT  
SERVICES

## The specialist for critical applications

- Control, command of LV facilities
- Safety of persons and assets
- Measurement of electrical parameters
- Energy management
- Energy quality
- Energy availability
- Energy storage
- Prevention and repairs
- Measurement and analysis
- Optimisation
- Consultancy, commissioning and training

## A worldwide presence

**12** production sites

- France (x3)
- Italy (x2)
- Tunisia
- India
- China (x2)
- USA (x3)

**28** subsidiaries and commercial locations

- Algeria • Australia • Belgium • China • Canada
- Dubai (United Arab Emirates) • France • Germany
- India • Indonesia • Italy • Ivory Coast • Netherlands
- Poland • Portugal • Romania • Serbia • Singapore
- Slovenia • South Africa • Spain • Switzerland
- Thailand • Tunisia • Turkey • UK • USA

**80** countries

where our brand is distributed

### HEAD OFFICE

#### SOCOMEK GROUP

SAS SOCOMEK capital 10 607 040 €  
R.C.S. Strasbourg B 548 500 149  
B.P. 60010 - 1, rue de Westhouse  
F-67235 Benfeld Cedex  
Tel. +33 3 88 57 41 41 - Fax +33 3 88 57 78 78  
info.scp.isd@socomec.com

[www.socomec.com](http://www.socomec.com)



### UK OFFICE

#### SOCOMEK U.K. Limited

Power Conversion (UPS)  
7-9 Lakeside Business Park,  
Broadway Lane, South Cerney,  
Gloucestershire, GL7 5XL.  
Tel. +44 (0) 333 015 3002  
info.uk@socomec.com

UK  
CA

### YOUR DISTRIBUTOR / PARTNER

**100** years  
OF SHARED ENERGY

**socomec**  
Innovative Power Solutions