

**Touch/Glass sensor 1gang
comfort with bus coupling unit**

**Touch/Glass sensor 2gang
comfort with bus coupling unit**

**Touch/Glass sensor 3gang
comfort with bus coupling unit**

**Touch/Glass sensor 4gang
comfort with bus coupling unit**

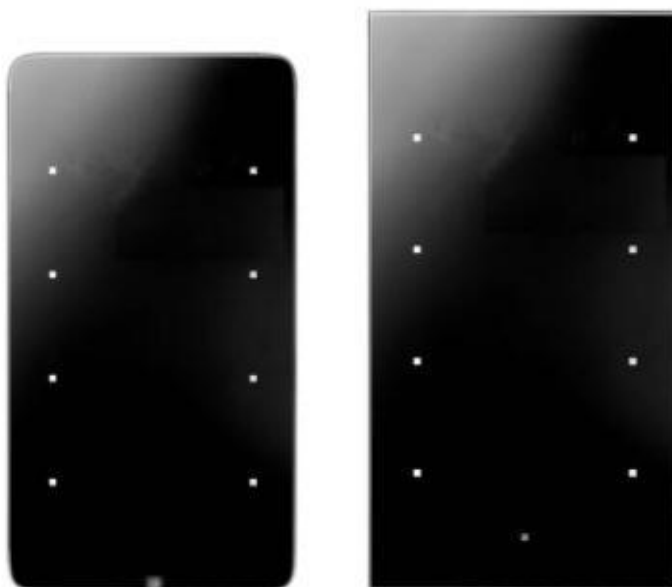

Issue: 13.11.2012
65770120

Contents

1	Product definition	3
1.1	Product catalogue	3
1.2	Function	3
1.3	Accessories	4
2	Installation, electrical connection and operation	5
2.1	Safety instructions	5
2.2	Device components	6
2.3	Fitting and electrical connection	7
2.4	Commissioning	11
2.5	Operation	12
3	Technical data	13
4	Software description	14
4.1	Software specification	14
4.2	Touch/Glass sensor comfort 110x11	16
4.2.1	Scope of functions	16
4.2.2	Notes on software	18
4.2.3	Object table	19
4.2.4	Functional description	32
4.2.4.1	Operation concept and button evaluation	32
4.2.4.2	General settings	37
4.2.4.3	Rockers and button functions	38
4.2.4.3.1	Switching function	38
4.2.4.3.2	Dimming function	39
4.2.4.3.3	"Blind" function	41
4.2.4.3.4	"Value transmitter" function	45
4.2.4.3.5	Scene extension function	47
4.2.4.3.6	"2-channel operation" function	48
4.2.4.4	Status LED	50
4.2.4.5	Scene control	53
4.2.4.5.1	Scene definition and scene recall	53
4.2.4.5.2	Storing scenes	55
4.2.4.6	Disabling function	56
4.2.4.7	Controller extension	59
4.2.4.7.1	Connection to room temperature controller	59
4.2.4.7.2	Button function "Operating mode switchover"	61
4.2.4.7.3	Button function "Presence button"	62
4.2.4.7.4	Button function "Setpoint shift"	63
4.2.4.8	Room temperature measurement	64
4.2.4.9	Cleaning function	66
4.2.4.10	Alarm signal	67
4.2.5	Delivery state	68
4.2.6	Parameters	69
5	Appendix	106
5.1	Index	106

1 Product definition

1.1 Product catalogue

Product name: Touch/Glass sensor 1gang comfort / Touch/Glass sensor 2gang comfort /
Touch/Glass sensor 3gang comfort / Touch/Glass sensor 4gang comfort

Use: Sensor

Design: FM (flush-mounted)

Order No. 751418xx / 751428xx / 751438xx / 751448xx

1.2 Function

The KNX glass/touch sensors consist of several sensor areas, which can be operated by touching them with your finger. The number of sensor areas depends on the device version. The design used (R.1, R.3, TS sensor) determines the design of the glass application. This product documentation describes the scope of functions of all the "Comfort" device variants of the glass/touch design ranges.

When the sensor areas are pressed, the devices send telegrams to the KNX / EIB, depending on the ETS parameter settings. These can be, for instance, telegrams for switching, for dimming or for controlling blinds. It is also possible to program value transmitter functions, such as dimming value transmitters, light scene extensions, temperature value transmitters or brightness value transmitters. In connection with a room temperature controller equipped with a 1-byte object for change-over of operating modes, the devices can be used as full-featured controller extensions.

In the ETS, the control concept of the operating areas can either be configured as a rocker function or as a button function. With the rocker function, two neighbouring sensor buttons are assigned an identical function. For the button function, each sensor area is evaluated separately, meaning that different functions can be executed. When two sensors surfaces are combined into one rocker, it is also possible to trigger special functions by a press on the whole surface. Full-surface operation is simultaneous operation of both sensor areas (left / right) of the rocker.

Next to each sensor surface, there is a status LED, which can be connected to the control function, according to the function of the rocker or button. Each status LEDs can then also signal completely independent display information, operating states of room temperature controllers or indicate the results of logic value comparisons, flash or be permanently switched on or off.

When used, one operation LED on each device can either serve as an orientation light, or can be activated via a separate communication object. When the devices are in the programming mode, the operation LEDs flash with a frequency of about 8 Hz. The same flashing rate is also used for indicating that a rocker switch has been actuated by a press on the full surface. If no application has been loaded, the operation LED flashes at a frequency of about 0.75 Hz to indicate an error. The devices do not then work.

Bus coupling units are already permanently integrated in the glass/touch sensors, allowing the devices to be connected directly to the bus cable during commissioning.

1.3 Accessories

Wall box 2gang
Floor temperature sensor/remote sensor

Order No. 1871
Order No. 161

2 Installation, electrical connection and operation

2.1 Safety instructions

Electrical equipment may only be installed and fitted by electrically skilled persons. The applicable accident prevention regulations must be observed.

Failure to observe the instructions may cause damage to the device and result in fire and other hazards.

Make sure during the installation that there is always sufficient insulation between the mains voltage and the bus. A minimum distance of at least 4 mm must be maintained between bus conductors and mains voltage cores.

The device may not be opened or operated outside the technical specifications.

Do not use sharp objects for cleaning. Do not use sharp cleaning agents, acids or organic solvents.

Do not operate the device with sharp or pointed objects. The surface could be damaged.

2.2 Device components

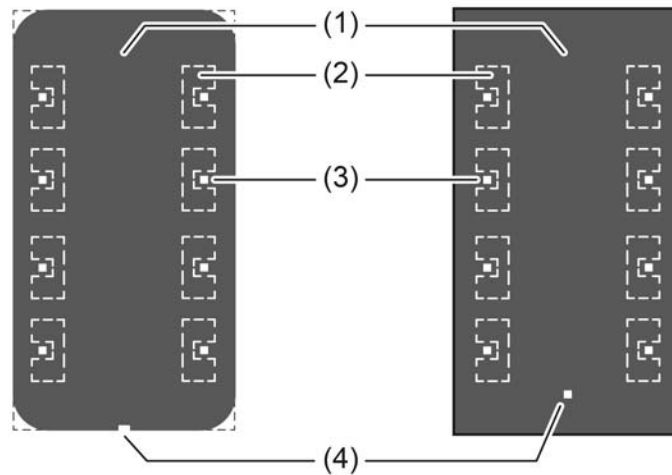

Figure 1: Device components, front side, using the "4-gang" variant as an example
Left R.x design / Right: TS sensor design

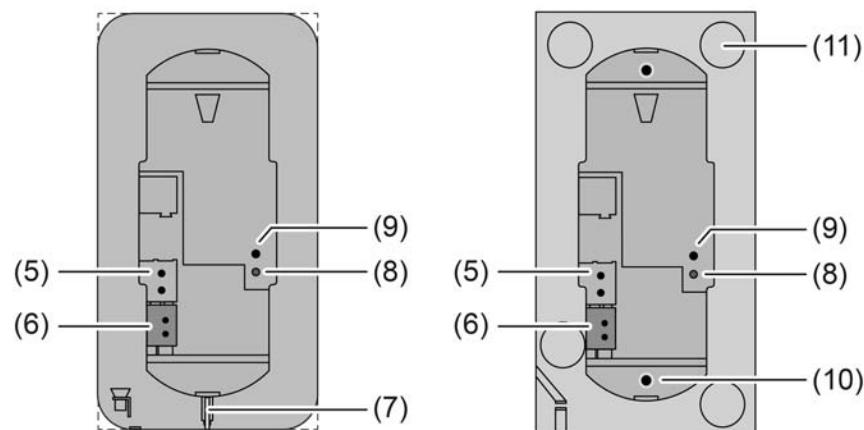

Figure 2: Device components, rear side
Left R.x design / Right: TS sensor design

- (1) User interface
- (2) Sensor buttons for operating functions (depending on the ETS configuration, as rocker or pushbutton function)
- (3) Status LED (1 x for each sensor area)
- (4) Operation LED
- (5) Screwless terminal connection for wired floor temperature/remote sensors (Accessories)
- (6) Screwless terminal connection for KNX bus line
- (7) Fibre-optic cable for operation LED
- (8) Programming LED (red)
- (9) Programming button
- (10) Retaining peg
- (11) Adhesion points for adhesive dots

2.3 Fitting and electrical connection

**DANGER!**

Electrical shock on contact with live parts in the installation environment.
Electrical shocks can be fatal.

Before working on the device, disconnect the power supply and cover up live parts in the working environment.

Mounting and connecting the R.x touch sensor

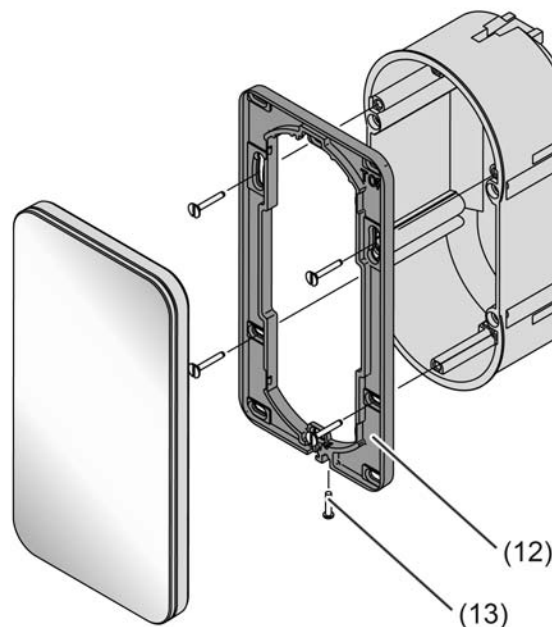

Figure 3: Device mounting of a Comfort touch sensor

(12) Mounting frame

(13) Retaining screw

The device is installed by screwing the mounting frame to the flush-mounted box or to the wall. Increased dismantling protection is achieved by securing the device on the bottom of the mounting frame using a retaining screw.

Use a 2-gang flush-mounted/appliance box (according to DIN 49073). Mounting on 1-gang flush-mounted/appliance boxes or surface-mounted boxes is not possible.

- Align the mounting frame (12) and screw it to the flush-mounted box or the wall (Figure 3). Observe marking TOP. Use the enclosed set of screws.
 - Connect the KNX cable with connecting terminal to the terminal (6).
 - Optional: Connect the external floor temperature/remote sensor to the terminal (5).
- i** Programming button and LED are accessible only from the back of the device. If possible, load the physical address into the device before the final installation.
- Attach the device onto the mounting frame until it locks in place.

- Tighten the retaining screw (13) on the bottom of the mounting frame. Use a Pozi-Drive screwdriver, size 0.

Preparing the Glass sensor TS for mounting on a smooth substrate

The adhesive dots prevent the glass sensor from slipping when mounted on smooth surfaces.

- Free the adhesion points for the adhesive dots on the rear side of the glass sensor (11) from impurities (Figure 2).
 - Remove the adhesive dots from the carrier film and stick them to the four adhesion points.
 - Free the substrate of impurities.
 - Before mounting the glass sensor, remove the protective film from the adhesive dots.
- i** Before completing mounting, align the glass sensor and press it in the area of the adhesive dots, in order to fix it in place.

Mounting and connecting the Glass sensor TS

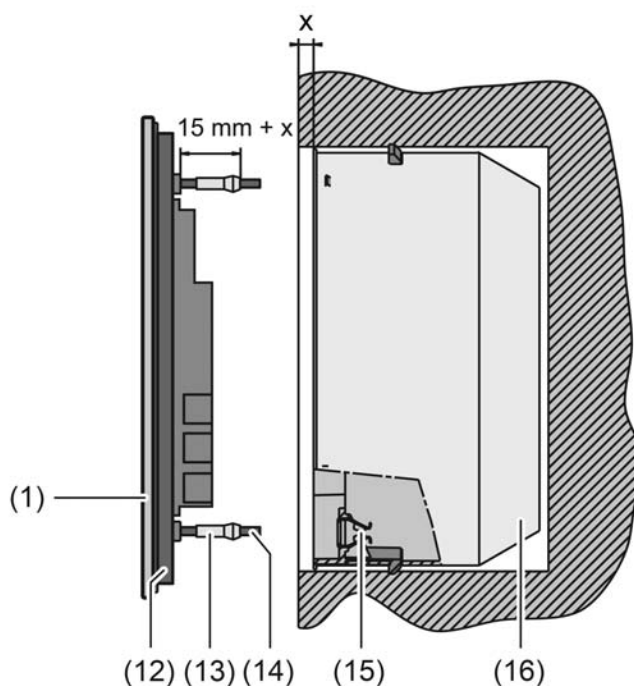

Figure 4: Device mounting of a TS Comfort glass sensor

- (1) User interface
- (12) Mounting frame
- (13) Retaining peg
- (14) Threaded pin
- (15) Friction spring
- (16) Appliance box for the TS glass sensor (accessory)

Use the appliance box for the 2-gang TS glass sensor (accessory). Mounting on 1-gang flush-mounted/appliance boxes or surface-mounted boxes is not possible.

Optional: For increased dismantling protection or to increase the shadow gap to the wall, use the enclosed mounting frame (12). For this, lock the mounting frame onto the device from behind. Observe marking TOP.

- If necessary, measure the surface compensation. With deeper installation sockets, adjusting the retaining pegs (13) on the threaded pins (14) allows a surface compensation of up to 20 mm. Unscrew the retaining pegs (13) by the surface compensation "x", so that they are at a distance of 15 mm + x from the socket for the threaded pins.
- ❗ When the mounting frame is used, the distance for the surface compensation is 20 mm + x from the socket for the threaded pins.
- Connect the KNX cable with connecting terminal to the terminal (6).
- Optional: Connect the external floor temperature/remote sensor to the terminal (5).
- ❗ Programming button and LED are accessible only from the back of the device. If possible, load the physical address into the device before the final installation.
- Insert the device with the threaded pins (14) into the friction springs (15) of the appliance box (16) and push it in until the retaining pegs noticeably lock into place.
- Align the device and push it in in the area of the retaining points to fix it.

Connecting and mounting the Glass sensor TS with increased dismantling protection

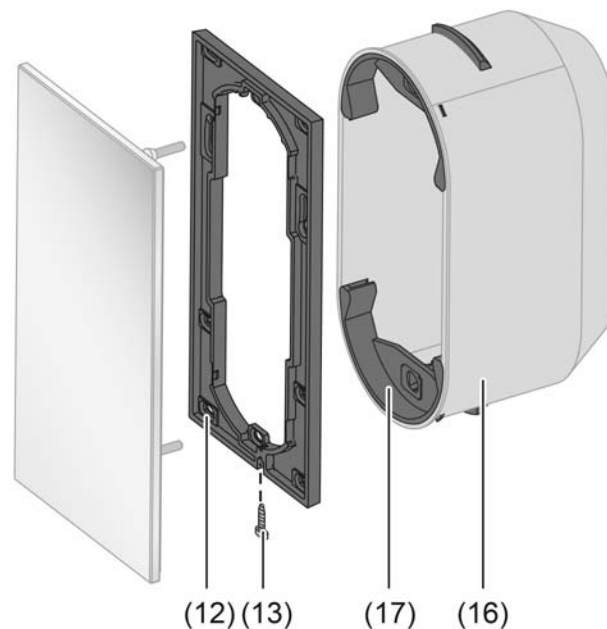

Figure 5: Device mounting of a TS Comfort glass sensor with increased dismantling protection

- (12) Mounting frame
- (13) Retaining screw
- (16) Appliance box for the TS glass sensor (accessory)
- (17) Friction spring seat

For increased dismantling protection, the mounting frame is firmly screwed to the appliance box or the wall and the device secured using a retaining screw on the bottom of the mounting frame.

- Lever the friction spring seats (17) out of the appliance box (16), in order to reveal the screw holes of the installation socket.
 - Align the mounting frame and screw it to the appliance box of the wall. Observe marking TOP. Use the enclosed set of screws.
 - Connect the KNX cable with connecting terminal to the terminal (6).
 - Optional: Connect the external floor temperature/remote sensor to the terminal (5).
- i** Programming button and LED are accessible only from the back of the device. If possible, load the physical address into the device before the final installation.
- Attach the device onto the mounting frame until it locks in place.
 - Tighten the retaining screw (13) on the bottom of the mounting frame. Use a Pozi-Drive screwdriver, size 0.

Dismantling the Glass sensor TS

- If available, slacken the retaining screw (13) on the bottom edge. Use a Pozi-Drive screwdriver, size 0.
- Press the enclosed dismantling too in the centre of the glass sensor.
- Using the dismantling tool, pull the glass sensor evenly out of the anchoring - friction springs or mounting frame.
- Disconnect the connection cables.

2.4 Commissioning

Programming the physical address and application program

The commissioning of the device is basically confined to programming of the physical address and the application program with the ETS.

Project planning and commissioning of the device using the ETS 3.0d with Patch A or newer versions.

The device is connected and ready for operation.

The rear side of the device must be accessible. Therefore, the device may not have been installed on the appliance box.

An appropriate device must be created and configured in the ETS project.

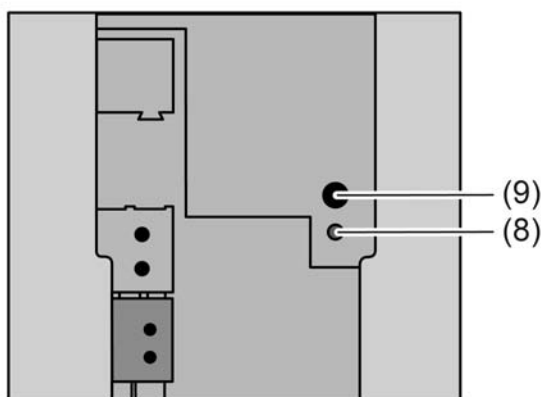

Figure 6: Programming buttons and LED on the rear side of the device

(8) Programming LED (red)

(9) Programming button

- Press the Programming button (9).
The programming LED (8) lights up. The device displays the programming status in this way.
 - Program the physical address with the help of the ETS.
The programming LED goes out.
 - Write the physical address on the device label.
 - Load the application program into the device using the ETS.
- i** When the physical address has been programmed, the device can finally be mounted.

2.5 Operation

Operating areas

The KNX glass/touch sensors consist of several sensor areas, which can be operated by touching them with your finger. The number of sensor areas depends on the device version. In the ETS, the control concept of the operating areas can either be configured as a rocker function or as a button function. With the rocker function, two neighbouring sensor buttons are assigned an identical function. For the button function, each sensor area is evaluated separately, meaning that different functions can be executed. When two sensors surfaces are combined into one rocker, it is also possible to trigger special functions by a press on the whole surface. Full-surface operation is simultaneous operation of both sensor areas (left / right) of the rocker.

Next to each sensor surface, there is a status LED, which can be connected to the control function, according to the function of the rocker or button. Each status LEDs can then also signal completely independent display information, operating states of room temperature controllers or indicate the results of logic value comparisons, flash or be permanently switched on or off.

When used, the operation LED can either serve as an orientation light, or can be activated via a separate communication object. When the devices are in the programming mode, the operation LEDs flash with a frequency of about 8 Hz. The same flashing rate is also used for indicating that a rocker switch has been actuated by a press on the full surface. If no application has been loaded, the operation LED flashes at a frequency of about 0.75 Hz to indicate an error. The devices do not then work.

- i** Configuration of the sensor surfaces (button or rocker function and button arrangement) is described in detail in the chapter "Software description"

3 Technical data

General

Degree of protection	IP 20
Protection class	III
Mark of approval	KNX/EIB
Ambient temperature	-5 ... +45 °C
Storage/transport temperature	-25 ... +70 °C
Relative humidity	0 ... 95 % (No moisture condensation)

KNX supply

KNX medium	TP 1
Commissioning mode	S-mode
Rated voltage KNX	DC 21 ... 32 V SELV
Current consumption KNX	max. 12.5 mA
Connection mode KNX	Connection terminal

Internal temperature sensor

Measuring range	0°C ...+40°C ±1%
Resolution	0.1 K

4 Software description

4.1 Software specification

ETS search paths:	Push button / Push button 1gang / Touch/Glass sensor 1gang comfort
	Push button / Push button 2gang / Touch/Glass sensor 2gang comfort
	Push button / Push button 3gang / Touch/Glass sensor 3gang comfort
	Push button / Push button 4gang / Touch/Glass sensor 4gang comfort
Configuration:	S-mode standard
PEI type:	"00" _{Hex} / "0" _{Dec}
PEI connector:	no connector

Applications for Touch/Glass sensor 1gang comfort:

No.	Short description	Name	Version	from mask version
1	Multifunctional pushbutton sensor application: 2 sensor buttons (1 x rocker switch / 2 x buttons)	Touch/Glass sensor 1gang comfort 110111	1.1 for ETS3.0 Version d onwards and ETS4	705

Applications for Touch/Glass sensor 2gang comfort:

No.	Short description	Name	Version	from mask version
1	Multifunctional pushbutton sensor application: 4 sensor buttons (2 x rockers / 4 x buttons)	Touch/Glass sensor 2gang comfort 110211	1.1 for ETS3.0 Version d onwards and ETS4	705

Applications for Touch/Glass sensor 3gang comfort:

No.	Short description	Name	Version	from mask version
1	Multifunctional pushbutton sensor application: 6 sensor buttons (3 x rockers / 6 x buttons)	Touch/Glass sensor 3gang comfort 110311	1.1 for ETS3.0 Version d onwards and ETS4	705

Applications for Touch/Glass sensor 4gang comfort:

No.	Short description	Name	Version	from mask version
1	Multifunctional pushbutton sensor application: 8 sensor buttons (4 x rockers / 8 x buttons)	Touch/Glass sensor 4gang comfort 110411	1.1 for ETS3.0 Version d onwards and ETS4	705

4.2 Touch/Glass sensor comfort 110x11

4.2.1 Scope of functions

Scope of functions

- The operation concept of the operating areas can either be configured as a rocker function or as a push-button function.
- For pushbutton function either double-surface or single-surface principle.
- Each rocker switch can be used for the functions 'switching', 'dimming', 'blind control', '1-byte value transmitter', '2-byte value transmitter', 'scene extension' and 2-channel operation.
- Each button can be used for the functions switching, dimming, blind control, 1-byte value transmitter, 2-byte value transmitter, scene extension, 2-channel extension and room temperature controller extension.
- 2-channel control: each rocker or each button can be set for controlling two independent channels. This means that only one operation is enough to transmit up to two telegrams to the bus. The channels can be configured independently of one another for the Switching, Value transmitter (1 byte) or Temperature value transmitter (2 bytes) functions.
- For the rocker functions Dimming, Venetian blind (operation concept "Long – Short or Short") and 2-channel operation, full-surface rocker actuation can also be evaluated. With full-surface rocker operation, switching telegrams and scene recall requests can be triggered on the bus in addition to and independently of the configured rocker function.
- The switching function permits the following settings: reaction after pressing and/or releasing, switch on, switch off, and toggle.
- The dimming function permits the following settings: times for short and long actuation, dimming in different levels, telegram repetition on long press, transmission of stop telegram after end of press.
- The shutter control permits the following settings: four different operation concepts with times for short and long press and slat adjustment.
- The 1-byte and 2-byte value transmitter function permits the following settings: selection of the value range (0 ... 100 %, 0 ... 255, 0 ... 65535, 0 ... 1500 lux, 0 ... 40 °C), value on button-press, value change on sustained button-press with different step widths, optional overflow on reaching the end of a value range.
- The scene control permits the following settings: Internal storage of eight scenes with eight output channels, recall of internal scenes by means of a presettable scene number, selection of object types for the output channels; for each scene, the storage of the individual output values and the transmission of the output values can be permitted or disabled; the individual channels can be delayed during scene recall; as scene extension 64 scenes can be recalled and stored.
- The controller extension function permits the following settings: operating mode selection with normal and high priority, defined selection of an operating mode, change between different operating modes, change of presence status, setpoint shift.
- There is as status LED available for each sensor area.
- When a status LED is internally connected with the rocker or the button, it can signal a button-press or the current status of a communication object. The status indication can also be in inverted form.
- When a status LED is not dependent on the rocker or button, it can be permanently on or off, indicate the status of an independent communication object, the operating state of a room temperature controller or the result of a comparison between signed or unsigned 1 byte values.
- The operation LED can be permanently on or off or alternatively be switched via a communication object.

- The rockers or buttons can be disabled via a 1-bit object. The following settings are possible: polarity of the disabling object, behaviour at the beginning and at the end of disabling. During an active disable, all or some of the rockers / buttons can have no function, can perform the function of a selected button or execute one of two presettable disabling functions.
- All LEDs of the device can flash simultaneously in the event of an alarm. The following settings are possible: Value of alarm signalling object for the states alarm / no alarm, alarm acknowledge by actuation of a button, transmission of the acknowledge signal to other devices.

4.2.2 Notes on software

ETS project design and commissioning

For configuration and commissioning of the device, ETS3.0d or more recent ETS version is required. We recommend using ETS4 of version 4.1 or higher. No product database is available for ETS2 and older versions of ETS3.

4.2.3 Object table

Number of communication objects:	32 (1x variant) 37 (2x variant) 43 (3x variant) 49 (4x variant) (max. object number 74 - gaps in between)
Number of addresses (max):	120
Number of assignments (max):	120
Dynamic table management	yes
Maximum table length	240

Objects for rocker or button function:

Function: Switching

Object	Function	Name	Type	DPT	Flag
 ⁰	Switching	Rocker/button 1 ^{1,2}	1-bit	1.xxx	C, W, T, (R) ³

Description 1-bit object for transmission of switching telegrams (ON, OFF).

Function: Dimming

Object	Function	Name	Type	DPT	Flag
 ⁰	Switching	Rocker/button 1 ^{1,2}	1-bit	1.xxx	C, W, T, (R) ³

Description 1-bit object for transmission of switching telegrams (ON, OFF).

Function: Dimming

Object	Function	Name	Type	DPT	Flag
 ¹⁸	Dimming	Rocker/button 1 ^{1,2}	4-bit	3.007	C, W, T, (R) ³

Description 4-bit object for the transmission of relative dimming telegrams.

1: The number of rockers or buttons depends on the planned device variant.

2: The objects have been described for rocker 1 or button 1 as an example. The objects for the other rockers/buttons are defined in the same way by shifting the object number and changing the object name.

3: For reading, the R-flag must be set. The last value written to the object via the bus will be read.

Function: Venetian blind

Object	Function	Name	Type	DPT	Flag
 ⁰	Short time operation	Rocker/button 1 ^{1,2}	1-bit	1.007	C, -, T, (R) ₃

Description 1-bit object for the transmission of telegrams with which a Venetian blind or shutter drive motor can be stopped or with which the blind slats can be adjusted by short time operation.

Function: Venetian blind

Object	Function	Name	Type	DPT	Flag
 ¹⁸	Long-time operation	Rocker/button 1 ^{1,2}	1-bit	1.008	C, W, T, (R) ₃

Description 1-bit object for the transmission of telegrams with which a Venetian blind or shutter drive motor can be moved upwards or downwards.

Function: 1-byte value transmitter

Object	Function	Name	Type	DPT	Flag
 ⁰	Value	Rocker/button 1 ^{1,2}	1 byte	5.xxx	C, W, T, (R) ₃

Description 1-byte object for the transmission of values from 0 to 255 (corresponding to values from 0 % to 100 %). If the adjustment of the value is enabled, the object can transmit telegrams cyclically after long actuation with which the value can be reduced or increased by a presettable amount.

Function: 2-byte value transmitter

Object	Function	Name	Type	DPT	Flag
 ⁰	Value	Rocker/button 1 ^{1,2}	2 byte	7.xxx	C, W, T, (R) ₃

Description 2-byte object for the transmission of values from 0 to 65535. If the adjustment of the value is enabled, the object can transmit cyclical telegrams after a long press with which the value can be reduced or increased by an adjustable amount.

1: The number of rockers or buttons depends on the planned device variant.

2: The objects have been described for rocker 1 or button 1 as an example. The objects for the other rockers/buttons are defined in the same way by shifting the object number and changing the object name.

3: For reading, the R-flag must be set. The last value written to the object via the bus will be read.

Function: 2-byte value transmitter

Object	Function	Name	Type	DPT	Flag
 ⁰	Temperature value	Rocker/button 1 ^{1,2}	2 byte	9.001	C, W, T, (R) ³

Description 2 -byte object for the transmission of a temperature value from 0 °C to 40 °C. If the adjustment of the value is enabled, the object can transmit telegrams cyclically after a long press with which the value can be reduced or increased by 1 K.

Function: 2-byte value transmitter

Object	Function	Name	Type	DPT	Flag
 ⁰	Brightness value	Rocker/button 1 ^{1,2}	2 byte	9.004	C, W, T, (R) ³

Description 2-byte object for the transmission of a brightness level value from 0 to 1500 lux. If the adjustment of the value is enabled, the object can transmit cyclical telegrams after a long press with which the value can be reduced or increased by 50 lux.

Function: Scene extension

Object	Function	Name	Type	DPT	Flag
 ⁰	Scene extension	Rocker/button 1 ^{1,2}	1 byte	18.001	C, -, T, (R) ₃

Description 1-byte object for recalling or for storing one of 64 scenes max. from a scene push button sensor.

Function: 2-channel operation

Object	Function	Name	Type	DPT	Flag
 ⁰	Channel 1 switching	Rocker/button 1 ^{1,2}	1-bit	1.xxx	C, W, T, (R) ³

Description 1-bit object for the transmission of switching telegrams, if 2-channel operation is activated.

Function: 2-channel operation

Object	Function	Name	Type	DPT	Flag
 ⁰	Channel 1 value	Rocker/button 1 ^{1,2}	1 byte	5.xxx	C, -, T, (R) ₃

Description 1-byte object for the transmission of value telegrams, if 2-channel operation is activated.

1: The number of rockers or buttons depends on the planned device variant.

2: The objects have been described for rocker 1 or button 1 as an example. The objects for the other rockers/buttons are defined in the same way by shifting the object number and changing the object name.

3: For reading, the R-flag must be set. The last value written to the object via the bus will be read.

Function: 2-channel operation

Object	Function	Name	Type	DPT	Flag
 ⁰	Channel 1 value	Rocker/button 1 ^{1,2}	2 byte	9.001	C, -, T, (R) ₃

Description 2-byte object for the transmission of value telegrams, if 2-channel operation is activated.

Function: 2-channel operation

Object	Function	Name	Type	DPT	Flag
 ¹⁸	Channel 2 switching	Rocker/button 1 ^{1,2}	1-bit	1.xxx	C, W, T, (R) ₃

Description 1-bit object for the transmission of switching telegrams, if 2-channel operation is activated.

Function: 2-channel operation

Object	Function	Name	Type	DPT	Flag
 ¹⁸	Channel 2 value	Rocker/button 1 ^{1,2}	1 byte	5.xxx	C, -, T, (R) ₃

Description 1-byte object for the transmission of value telegrams, if 2-channel operation is activated.

Function: 2-channel operation

Object	Function	Name	Type	DPT	Flag
 ¹⁸	Channel 2 value	Rocker/button 1 ^{1,2}	2 byte	9.001	C, -, T, (R) ₃

Description 2-byte object for the transmission of value telegrams, if 2-channel operation is activated.

1: The number of rockers or buttons depends on the planned device variant.

2: The objects have been described for rocker 1 or button 1 as an example. The objects for the other rockers/buttons are defined in the same way by shifting the object number and changing the object name.

3: For reading, the R-flag must be set. The last value written to the object via the bus will be read.

Objects for full-surface operation with rocker function (with dimming, Venetian blind and 2-channel operation):

Function: Full-surface operation

Object	Function	Name	Type	DPT	Flag
 ¹	Switching	Rocker 1 full-surface operation _{1,2}	1-bit	1.xxx	C, W, T, (R) ³

Description 1-bit object for the transmission of switching telegrams (ON, OFF) when there is full-surface operation of an operating area.

Function: Full-surface operation

Object	Function	Name	Type	DPT	Flag
 ¹	Scene extension	Rocker 1 full-surface operation _{1,2}	1 byte	18.001	C, -, T, (R) ₃

Description 1-byte object for recalling or for storing one of 64 scenes max. from a scene push button sensor in case of full-surface operation of an operating area.

Objects for status LED:

Function: Status LED in case of rocker function

Object	Function	Name	Type	DPT	Flag
 ³⁶	Status LED left	Rocker 1 ^{1,2}	1-bit	1.xxx	C, W, -, (R) ₃

Description 1-bit object for activation of the status LED.

Function: Status LED in case of rocker function

Object	Function	Name	Type	DPT	Flag
 ³⁶	Status LED left	Rocker 1 ^{1,2}	1 byte	5.xxx, 6.xxx, 20.102	C, W, -, (R) ₃

Description 1-byte object for activation of the status LED.

1: The number of rockers or buttons depends on the planned device variant.

2: The objects have been described for rocker 1 or button 1 as an example. The objects for the other rockers/buttons are defined in the same way by shifting the object number and changing the object name.

3: For reading, the R-flag must be set. The last value written to the object via the bus will be read.

Function: Status LED in case of rocker function

Object	Function	Name	Type	DPT	Flag
 ³⁷	Status LED right	Rocker 1 ^{1,2}	1-bit	1.xxx	C, W, -, (R) ₃

Description 1-bit object for activation of the status LED.

Function: Status LED in case of rocker function

Object	Function	Name	Type	DPT	Flag
 ³⁷	Status LED right	Rocker 1 ^{1,2}	1 byte	5.xxx, 6.xxx, 20.102	C, W, -, (R) ₃

Description 1-byte object for activation of the status LED.

Function: Status LED in case of push button function

Object	Function	Name	Type	DPT	Flag
 ³⁶	Status LED	Button 1 ^{1,2}	1-bit	1.xxx	C, W, -, (R) ₃

Description 1-bit object for activation of the status LED.

Function: Status LED in case of push button function

Object	Function	Name	Type	DPT	Flag
 ³⁶	Status LED	Button 1 ^{1,2}	1 byte	5.xxx, 6.xxx, 20.102	C, W, -, (R) ₃

Description 1-byte object for activation of the status LED.

Objects for disabling functions:

Function: Switching

Object	Function	Name	Type	DPT	Flag
 ^{16, 17}	Switching	Disabling function 1 / 2	1-bit	1.xxx	C, W, T, (R) ₃

Description 1-bit object for transmission of switching telegrams (ON, OFF).

1: The number of rockers or buttons depends on the planned device variant.

2: The objects have been described for rocker 1 or button 1 as an example. The objects for the other rockers/buttons are defined in the same way by shifting the object number and changing the object name.

3: For reading, the R-flag must be set. The last value written to the object via the bus will be read.

Function: Dimming

Object	Function	Name	Type	DPT	Flag
 16, 17	Switching	Disabling function 1 / 2	1-bit	1.xxx	C, W, T, (R) ¹

Description 1-bit object for transmission of switching telegrams (ON, OFF).

Function: Dimming

Object	Function	Name	Type	DPT	Flag
 34, 35	Dimming	Disabling function 1 / 2	4-bit	1.007	C, W, T, (R) ¹

Description 4-bit object for the transmission of relative dimming telegrams.

Function: Venetian blind

Object	Function	Name	Type	DPT	Flag
 16, 17	Short time operation	Disabling function 1 / 2	1-bit	1.007	C, -, T, (R) ¹

Description 1-bit object for the transmission of telegrams with which a Venetian blind or shutter drive motor can be stopped or with which the blind slats can be adjusted by short time operation.

Function: Venetian blind

Object	Function	Name	Type	DPT	Flag
 34, 35	Long-time operation	Disabling function 1 / 2	1-bit	1.008	C, W, T, (R) ¹

Description 1-bit object for the transmission of telegrams with which a Venetian blind or shutter drive motor can be moved upwards or downwards.

Function: 1-byte value transmitter

Object	Function	Name	Type	DPT	Flag
 16, 17	Value	Disabling function 1 / 2	1 byte	5.xxx	C, W, T, (R) ¹

Description 1-byte object for the transmission of values from 0 to 255 (corresponding to values from 0 % to 100 %). If the adjustment of the value is enabled, the object can transmit telegrams cyclically after long actuation with which the value can be reduced or increased by a presettable amount.

1: For reading, the R-flag must be set. The last value written to the object via the bus will be read.

Function: 2-byte value transmitter

Object	Function	Name	Type	DPT	Flag
 16, 17	Value	Disabling function 1 / 2	2 byte	7.xxx	C, W, T, (R) ¹

Description 2-byte object for the transmission of values from 0 to 65535. If the adjustment of the value is enabled, the object can transmit cyclical telegrams after a long press with which the value can be reduced or increased by an adjustable amount.

Function: 2-byte value transmitter

Object	Function	Name	Type	DPT	Flag
 16, 17	Temperature value	Disabling function 1 / 2	2 byte	9.001	C, W, T, (R) ¹

Description 2 -byte object for the transmission of a temperature value from 0 °C to 40 °C. If the adjustment of the value is enabled, the object can transmit telegrams cyclically after a long press with which the value can be reduced or increased by 1 K.

Function: 2-byte value transmitter

Object	Function	Name	Type	DPT	Flag
 16, 17	Brightness value	Disabling function 1 / 2	2 byte	9.004	C, W, T, (R) ¹

Description 2-byte object for the transmission of a brightness level value from 0 to 1500 lux. If the adjustment of the value is enabled, the object can transmit cyclical telegrams after a long press with which the value can be reduced or increased by 50 lux.

Function: Scene extension

Object	Function	Name	Type	DPT	Flag
 16, 17	Scene extension	Disabling function 1 / 2	1 byte	18.001	C, -, T, (R) 1

Description 1-byte object for recalling or for storing one of 64 scenes max. from a scene push button sensor.

Function: 2-channel operation

Object	Function	Name	Type	DPT	Flag
 16, 17	Channel 1 switching	Disabling function 1 / 2	1-bit	1.xxx	C, W, T, (R) ¹

Description 1-bit object for the transmission of switching telegrams, if 2-channel operation is activated.

1: For reading, the R-flag must be set. The last value written to the object via the bus will be read.

Function: 2-channel operation

Object	Function	Name	Type	DPT	Flag
 16, 17	Channel 1 value	Disabling function 1 / 2	1 byte	5.xxx	C, -, T, (R) 1

Description 1-byte object for the transmission of value telegrams, if 2-channel operation is activated.

Function: 2-channel operation

Object	Function	Name	Type	DPT	Flag
 16, 17	Channel 1 value	Disabling function 1 / 2	2 byte	9.001	C, -, T, (R) 1

Description 2-byte object for the transmission of value telegrams, if 2-channel operation is activated.

Function: 2-channel operation

Object	Function	Name	Type	DPT	Flag
 34, 35	Channel 2 switching	Disabling function 1 / 2	1-bit	1.xxx	C, W, T, (R) 1

Description 1-bit object for the transmission of switching telegrams, if 2-channel operation is activated.

Function: 2-channel operation

Object	Function	Name	Type	DPT	Flag
 34, 35	Channel 2 value	Disabling function 1 / 2	1 byte	5.xxx	C, -, T, (R) 1

Description 1-byte object for the transmission of value telegrams, if 2-channel operation is activated.

Function: 2-channel operation

Object	Function	Name	Type	DPT	Flag
 34, 35	Channel 2 value	Disabling function 1 / 2	2 byte	9.001	C, -, T, (R) 1

Description 2-byte object for the transmission of value telegrams, if 2-channel operation is activated.

1: For reading, the R-flag must be set. The last value written to the object via the bus will be read.

Function: Disabling function

Object	Function	Name	Type	DPT	Flag
 ⁵⁴	Disabling	Button disabling	1-bit	1.001	C, W, -, (R) 1

Description 1-bit object by means of which the device can be disabled and enabled again (polarity configurable).

Object for the operation LED:

Function: Operation LED

Object	Function	Name	Type	DPT	Flag
 ⁵²	Operation LED	Switching	1-bit	1.001	C, W, -, (R) 1

Description 1-bit object to switch on or switch off the operation LED (polarity configurable).

Objects for the alarm signalling:

Function: Alarm signal

Object	Function	Name	Type	DPT	Flag
 ⁵⁶	Switching	Alarm signal	1-bit	1.xxx	C, W, -, (R) 1

Description 1-bit object for the reception of an alarm signalling (polarity configurable).

Function: Alarm signal

Object	Function	Name	Type	DPT	Flag
 ⁵⁷	Switching	Alarm message acknowledge	1-bit	1.xxx	C, -, T, (R) 1

Description 1-bit object for transmitting the acknowledgement of an alarm signalling (polarity configurable).

1: For reading, the R-flag must be set. The last value written to the object via the bus will be read.

Objects for the controller extension:

Function: Controller extension

Object	Function	Name	Type	DPT	Flag
 ⁵⁸	Operating mode switch-over	Controller extension	1 byte	20.102	C, W, T, (R) ¹

Description 1-byte object for changing over a room temperature controller between the Comfort, Standby, Night and Frost/heat protection operating modes.

Function: Controller extension

Object	Function	Name	Type	DPT	Flag
 ⁵⁹	Forced operating mode switch-over	Controller extension	1 byte	20.102	C, W, T, (R) ¹

Description 1-byte object for changing over a room temperature controller under forced control between the Automatic, Comfort, Standby, Night and Frost / heat protection operating modes.

Function: Controller extension

Object	Function	Name	Type	DPT	Flag
 ⁶⁰	Presence button	Controller extension	1-bit	1.001	C, W, T, (R) ¹

Description 1-bit object for switching over the presence status of a room temperature controller (polarity configurable)

Function: Controller extension

Object	Function	Name	Type	DPT	Flag
 ⁶¹	Setpoint shift specification	Controller extension	1 byte	6.010	C, -, T, (R) ¹

Description 1-byte object for presetting a basic setpoint shift for a controller.
 $x \leq 0 \leq y$ (0 = no shift active); integral numbers
 Value object 62 + 1 (increase level value)
 Value object 62 - 1 (decrease level value)
 The possible range of values (x to y) is fixed by the setpoint adjusting range to the 'upper limit' or to the 'lower limit' (configurable) in combination with the level value on the room temperature controller.

1: For reading, the R-flag must be set. The last value written to the object via the bus will be read.

Function: Controller extension

Object	Function	Name	Type	DPT	Flag
 ⁶²	Current setpoint shift	Controller extension	1 byte	6.010	C, W, T, (R) ¹

Description 1-byte object used by the extension unit for receiving the current setpoint shift of the room temperature controller.
 $x \leq 0 \leq y$ (0 = no shift active); integral numbers
 The possible range of values (x to y) is fixed by the setpoint adjusting range to the 'upper limit' or to the 'lower limit' (configurable) in combination with the level value on the room temperature controller.

Function: Controller extension

Object	Function	Name	Type	DPT	Flag
 ⁶³	Controller status	Controller extension	1 byte	Not defined	C, W, T, (R) ¹

Description 1-byte object used by the extension unit for receiving the current state of operation of the controller. Status LEDs that can be used to indicate a status independently of a button function can display one of the various information units which are grouped in this byte (bit-oriented evaluation).

Objects for the room temperature measurement:

Function: Room temperature measurement

Object	Function	Name	Type	DPT	Flag
 ⁶⁴	Measured temperature	Room temperature measurement	2 byte	9.001	C, -, T, (R) ₁

Description 2-byte object, via which the room temperature measured value determined by the device can be made available to other bus subscribers.

Function: Room temperature measurement

Object	Function	Name	Type	DPT	Flag
 ⁶⁵	Wired temperature sensor	Room temperature measurement	2 byte	9.001	C, -, -, R

Description 2-byte object, using which the isolated temperature measured value of the wired temperature sensor can be read out by other bus subscribers. The object can only be read out. Transmission of an external temperature value to this object (setting of the "Write" flag) is not permitted.

1: For reading, the R-flag must be set. The last value written to the object via the bus will be read.

Objects for the scene function:

Function: Scene function

Object	Function	Name	Type	DPT	Flag
 ^{66...73}	Switching	Scene output 1 ¹	1-bit	1.001	C, W, T, (R) ²

Description 1-bit objects for controlling up to eight actuator groups (ON, OFF).

Function: Scene function

Object	Function	Name	Type	DPT	Flag
 ^{66...73}	Value	Scene output 1 ¹	1 byte	5.001	C, W, T, (R) ²

Description 1-byte objects for controlling up to eight actuator groups (0...255).

Function: Scene function

Object	Function	Name	Type	DPT	Flag
 ⁷⁴	Extension unit input	Scene	1 byte	18.001	C, W, -, (R) ₂

Description 1-byte object with which one of the eight internally stored scenes can be recalled or stored again.

Object for the cleaning function:

Function: Cleaning function

Object	Function	Name	Type	DPT	Flag
 ²⁶	Cleaning function	Switching	1-bit	1.001	C, W, -, (R) ₂

Description 1-bit object for switching on the cleaning function (deactivation of the sensor surface to allow cleaning of the glass pane). The cleaning function is started using a "1" telegram and terminated automatically after 60 seconds (locking time). Additional "1" telegrams during the blocking time start this time again. "0" telegrams to the object do not product a reaction.

1: Scene outputs 2 ... 8 see scene output 1, shift of the object number (66 + number of scene output - 1).

2: For reading, the R-flag must be set. The last value written to the object via the bus will be read.

4.2.4 Functional description

4.2.4.1 Operation concept and button evaluation

Operating areas

The KNX glass/touch sensors consist of several sensor areas, which can be operated by touching them with your finger. The number of sensor areas depends on the device version. In the ETS, the control concept of the operating areas can either be configured as a rocker function or as a button function. With the rocker function, two neighbouring sensor buttons are assigned an identical function. For the button function, each sensor area is evaluated separately, meaning that different functions can be executed.

When two sensors surfaces are combined into one rocker, it is also possible to trigger special functions by a press on the whole surface. Full-surface operation is simultaneous operation of both sensor areas (left / right) of the rocker.

Next to each sensor surface, there is a status LED, which can be connected to the control function, according to the function of the rocker or button. Each status LEDs can then also signal completely independent display information, operating states of room temperature controllers or indicate the results of logic value comparisons, flash or be permanently switched on or off.

When used, the operation LED can either serve as an orientation light, or can be activated via a separate communication object. When the devices are in the programming mode, the operation LEDs flash with a frequency of about 8 Hz. The same flashing rate is also used for indicating that a rocker switch has been actuated by a press on the full surface. If no application has been loaded, the operation LED flashes at a frequency of about 0.75 Hz to indicate an error. The devices do not then work.

Moreover, the KNX Comfort glass/touch sensors have functions which are not immediately linked with the rockers or buttons and which must therefore be additionally enabled by the corresponding parameters. These include the thermostat extension function, pushbutton function disable, the internal scenes, the display of alarm signals and the cleaning function.

Button pair as rocker function

In the rocker operating concept, two adjacent sensor areas are used as a rocker. The two sensor areas are then termed the left and right rocker buttons. Pressing the buttons affect the communication objects assigned to the rocker. Usually, pressing both sides of a socket can directly opposite reactions (e.g. switching: left ON - right OFF / Venetian blind: left UP - right DOWN).

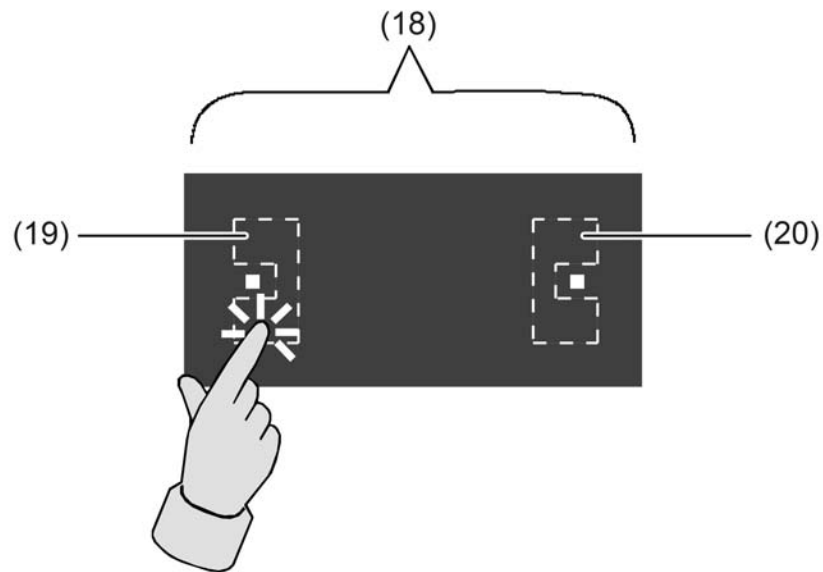

Figure 7: Rocker operation, left

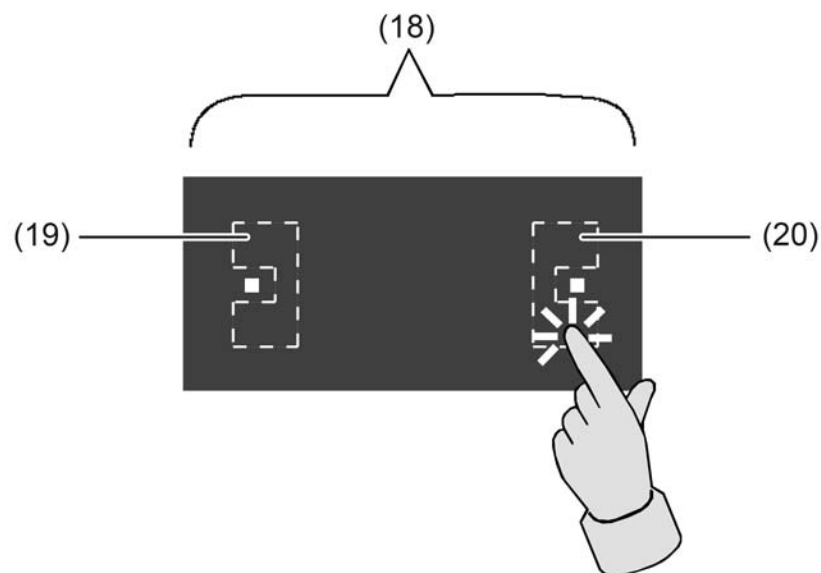

Figure 8: Rocker operation, right

(18) Rocker

(19) Left button of the rocker

(20) Right button of the rocker

Full-surface operation with rocker function

Depending on the function setting of a rocker, full-surface operation can also be optionally configured. This allows execution of additional functions, separate from the basic rocker function. Full-surface operation is simultaneous operation of both sensor areas (left / right) of a rocker.

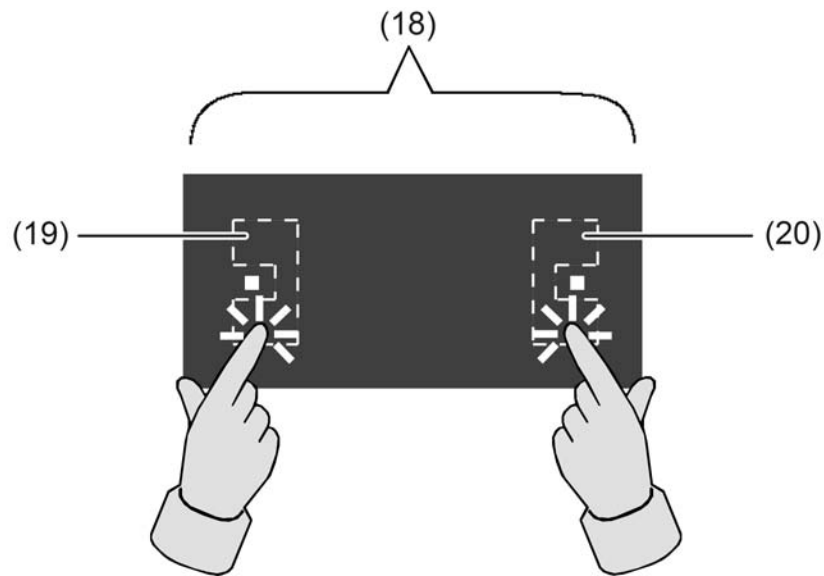

Figure 9: Full-surface rocker operation

(18) Rocker

(19) Left button of the rocker

(20) Right button of the rocker

i Full-surface operation can only be configured in the rocker function.

Button pair as push-button function

With the push button function, a distinction is made whether neighbouring sensor areas are divided into two separate and functionally independent buttons (double-surface operation), or are combined into a single "large" button (single-surface operation).

The parameter "Button evaluation" on the parameter page "Operation concept..." configures either double-surface or single-surface operation for neighbouring sensor areas.

In double-surface operation the buttons are configured independently of each other, and can fulfil completely different functions (e.g. switching: TOGGLE – thermostat operating mode: Comfort).

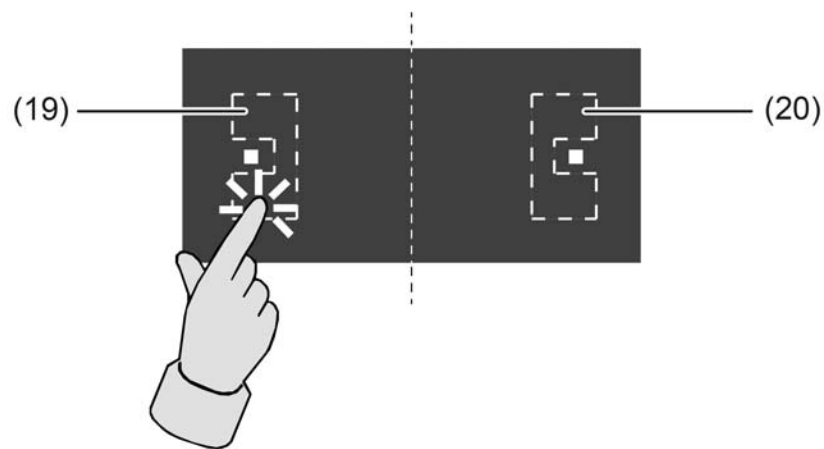

Figure 10: Button operation (two-button operation)

(19) Left button (irrespective of the right button)

(20) Right button (irrespective of the left button)

In single-surface operation, neighbouring sensor areas are evaluated only as a single "large" button. This button is configured independently of the other buttons or rockers of the push button sensor and can fulfil various functions (e.g. Switching: TOGGLE). Single-surface operation is simultaneous operation of neighbouring sensor areas (left / right).

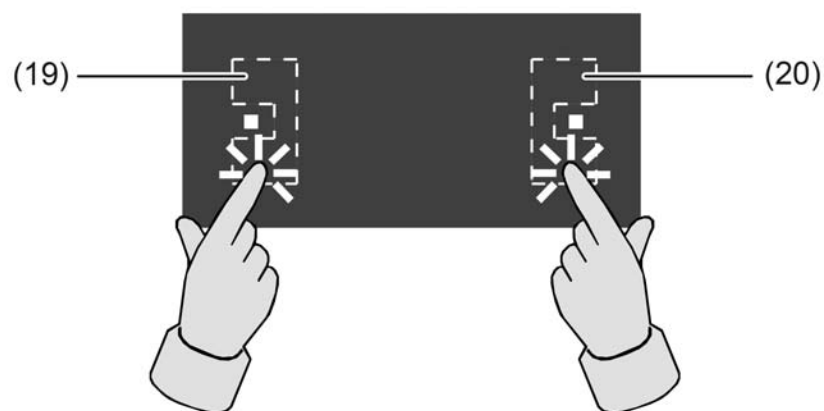

Figure 11: Button operation (single-button operation)

(19) Left button (configurable)

(20) Right button (not configurable)

Neighbouring sensor areas are always created in the ETS as a button pair. However, because in single-surface operation only one button functionally exists, the second button of the button pair has no function. During configuration in the ETS it is shown as a "not present" button without any further button parameters. Only the status LED of this button which is not used can be configured separately and if needed also activated via its own communication object. The present button which is to be evaluated in single-surface operation is always created as a button with an uneven button number.

4.2.4.2 General settings

Operation LED

The operation LED is used for different display functions which are in part fixed default functions...

- In a non-programmed device (delivery state) or after downloading of a wrong application program, the operating LED flashes at a slow rate of 0.75 Hz.
- When the device is switched over into the programming mode for commissioning or for ETS diagnosis purposes, the LED flashes at a fast rate of about 8 Hz (see page 11).
- To confirm the detection of a full-surface press with the rocker function, the LED flashes with 8 Hz, too.

The application software allows the setting of addition functions using the ETS parameter "Function of the Operation LED" on the "General" parameter page...

- The operating LED can flash together with all other status LEDs with a frequency of about 2 Hz, when the communication object for the alarm signalling is active.
- The LED can display the status of a separate communication object in inverted or non-inverted form. Here the operation LED can also be activated as flashing with a frequency of approx. 2 Hz.
- For orientation, the operation LED of the pushbutton sensor can be switched permanently on or off.
- It can flash continuously at a slow frequency of about 0.75 Hz.

If several of the above states occur at the same time, the following priority is taken into account:

1. Display of the programming mode.
2. Display of a valid full-surface actuation with the rocker function.
3. Display of an alarm.
4. Status display for the separate communication object or the states (flashing, ON, OFF).

Transmission delay

After a device reset (e.g. after the application program or the physical address is loaded or after the bus voltage is switched on), the device for the room temperature controller extension unit function can transmit telegrams automatically. The device then attempts to retrieve values from the room temperature controller by means of read telegrams in order to update the object states.

If there are still other devices installed in the bus which transmit telegrams immediately after a reset, it may be useful to activate the transmit delay for automatically transmitting objects on the "General" page in order to reduce the bus load.

When transmit delay is activated, the device determines the value of its individual delay from the device number of its physical address (phys. address: area.line.device number). This value can be about 30 seconds maximum. Without setting a special time delay, this principle prevents multiple bus subscribers from trying to transmit telegrams to the bus at the same time.

 The transmit delay is not active for the rocker or button functions.

4.2.4.3 Rockers and button functions

The following contains descriptions of the various functions that can be configured for each rocker or each button of the device.

4.2.4.3.1 Switching function

For each rocker or each button with the function set to "Switching", the ETS indicates a 1-bit communication object. The parameters of the rocker or button permit fixing the value this object is to adopt on pressing and / or on releasing (ON, OFF, TOGGLE – toggling of the object value). No distinction is made between a brief or long press.

4.2.4.3.2 Dimming function

For each rocker or each button with the function set to "Dimming", the ETS indicates a 1-bit object and a 4-bit object. Generally, the device transmits a switching telegram after a brief press and a dimming telegram after a long press. In the standard parameterisation the device transmits a telegram for stopping the dimming action after a long press. The time needed by the device to detect an actuation as a long actuation can be set in the parameters.

Single-surface and double-surface operation in the dimming function

In the rocker function, the device is preprogrammed for double-surface operation for the dimming function. This means that the device transmits a telegram for switching on after a brief press and a telegram for increasing the brightness after a long press ("Brighter"). Similarly, the device transmits a telegram for switching off after a brief press and a telegram for reducing the brightness after a long press ("Darker").

In the separate buttons function, the device is preprogrammed for single-surface dimming function. In this mode, the device transmits on each brief press ON and OFF telegrams in an alternating pattern ("TOGGLE"). After a long press, the device transmits "brighter" and "darker" telegrams in an alternating pattern.

The parameter "Command on pressing the button" or "Command on pressing the rocker" on the parameter pages of the buttons or rockers defines the single-surface or double-surface dimming function.

For the rocker and also for the button function, the command issued on pressing the button or rocker can basically be selected at the user's discretion.

If the actuator can be controlled from several sensors, a faultless single-surface operation requires that the addressed actuator reports its switching state back to the 1-bit object of the button or rocker and that the 4-bit objects of the devices are interlinked. The device would otherwise not be able to detect that the actuator has been addressed from another sensor, in which case it would have to be actuated twice during the next use in order to produce the desired reaction.

Advanced parameters

For the dimming function, the device can be programmed with advanced parameters which are hidden in the standard view for greater clarity. If necessary, these advanced parameters can be activated and thus be made visible.

The advanced parameters can be used to determine whether the device is to cover the full adjusting range of the actuator with one dimming telegram continuously ("Increase brightness by 100 %", "Reduce brightness by 100 %") or whether the dimming range is to be divided into several small levels (50 %, 25 %, 12.5 %, 6 %, 3 %, 1.5 %).

In the continuous dimming mode (100%), the device transmits a telegram only at the beginning of the long press to start the dimming process and generally a stop telegram after the end of the press. For dimming in small levels it may be useful if the device repeats the dimming telegram in case of a sustained press for a presettable time (parameter "Telegram repetition"). The stop telegram after the end of the press is then not needed.

When the parameters are hidden ("Advanced parameters = deactivated"), the dimming range is set to 100 %, the stop telegram is activated and the telegram repetition is deactivated.

Full-surface operation

When a rocker is used for dimming, the device needs some time at the beginning of each operation in order to distinguish between a short and a long operation. When full-surface operation is enabled, the device can make use of this time span to evaluate the otherwise invalid simultaneous actuation of both actuation points.

The device detects a full-surface operation of a rocker, if an operating area is depressed over a

large area so that both actuation points of the rocker are actuated.

When the device has detected a valid full-surface actuation, the operation LED flashes quickly at a rate of about 8 Hz for the duration of such actuation. Full-surface operation must have been detected before the first telegram has been transmitted by the dimming function (switching or dimming). If this is not so, even a full-surface operation will be interpreted as a wrong operation and not be executed.

Full-surface actuation is independent. It has a communication object of its own and can optionally be used for switching (ON, OFF, TOGGLE – toggling of the object value) or for scene recall without or with storage function. In the last case, a press on the full surface causes a scene to be recalled in less than a second. If the device is to send the telegram for storing a scene, full-surface actuation must be maintained for more than five seconds. If full-surface actuation ends between the first and the fifth second, the device will not send any telegrams. If the status LEDs of the rocker are used as "button-press displays", they will light up for three seconds during transmission of the storage telegram.

- i Full-surface actuation cannot be configured in the push button functions. There it is possible to configure the single-surface principle, which also allows an operating area to be depressed at the centre or over a large area.

4.2.4.3.3 "Blind" function

For each rocker or each button with the function set to "Venetian blind" the ETS indicates the two 1-bit objects "STEP operation" and "MOVE operation".

Operation concept for the Venetian blind function

For the control of Venetian blind, roller shutter, awning or similar drives, the device supports four operation concepts in which the telegrams are transmitted in different time sequences. The device can therefore be used to operate a wide variety of drive configurations.

The different operation concepts are described in detail in the following chapters.

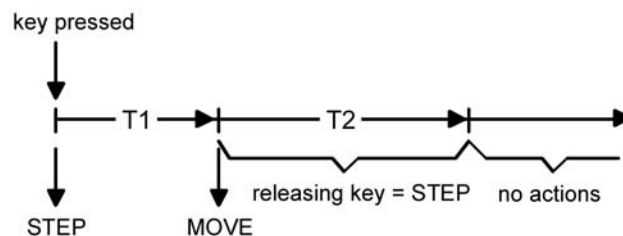

Figure 12: Operation concept "short – long – short"

Operation concept "short - long – short":

In the operation concept "short – long – short", the device shows the following behaviour:

- Immediately on pressing the button, the device transmits a short time telegram. Pressing the button stops a running drive and starts time T1 ("time between short time and long time command"). No other telegram will be transmitted, if the key is released within T1. This short time serves the purpose of stopping a continuous movement. The "time between short and long time command" in the device should be selected shorter than the short-time operation of the actuator to prevent a jerky movement of the blind.
- If the button is kept depressed longer than T1, the push button sensor transmits a long time telegram after the end of T1 for starting up the drive and time T2 ("slat adjusting time") is started.
- If the button is released within the slat adjusting time, the device sends another short time telegram. This function is used for adjusting the slats of a blind. The function permits stopping the slats in any position during their rotation. The "slat adjusting time" should be chosen as required by the drive for a complete rotation of the slats. If the "slat adjusting time" is selected longer than the complete running time of the drive, a push button function is possible as well. This means that the drive is active only when the button is kept depressed.
- If the button is kept depressed longer than T2, the device transmits no further telegram. The drive remains on until the end position is reached.

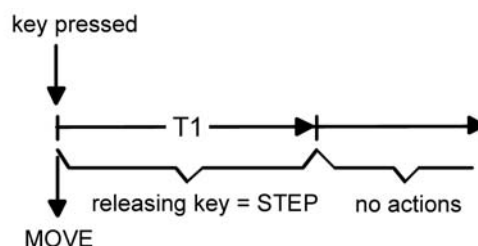

Figure 13: Operation concept "long – short"

Operation concept "long – short":

In the operation concept "long – short", the device shows the following behaviour:

- Immediately on pressing the button, the device transmits a long time telegram. The drive begins to move and time T1 ("slat adjusting time") is started.
- If the button is released within the slat adjusting time, the device sends a short time telegram. This function is used for adjusting the slats of a blind. The function permits stopping the slats in any position during their rotation.
The "slat adjusting time" should be chosen as required by the drive for a complete rotation of the slats. If the "slat adjusting time" is selected longer than the complete running time of the drive, a push button function is possible as well. This means that the drive is active only when the button is kept depressed.
- If the button is kept depressed longer than T1, the device transmits no further telegram. The drive remains on until the end position is reached.

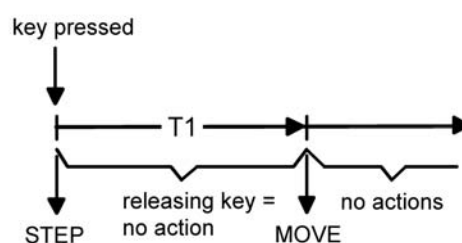

Figure 14: Operation concept "short – long"

Operation concept "short – long":

In the operation concept "short – long", the device shows the following behaviour:

- Immediately on pressing the button, the device transmits a short time telegram. Pressing the button stops a running drive and starts time T1 ("time between short time and long time command"). No other telegram will be transmitted, if the key is released within T1. This short time serves the purpose of stopping a continuous movement.
The "time between short and long time command" in the push button sensor should be selected shorter than the short time operation of the actuator to prevent a jerky movement of the blind.
- If the button is kept depressed longer than T1, the push button sensor transmits a long time telegram after the end of T1 for starting the drive.
- No further telegram is transmitted when the button is released. The drive remains on until the end position is reached.

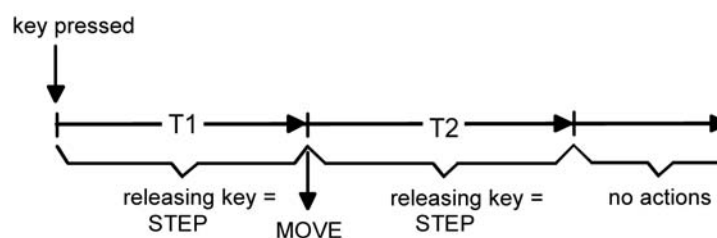

Figure 15: Operation concept "long – short or short"

Operation concept "long – short or short":

In the operation concept "long – short or short", the device shows the following behaviour:

- Immediately on pressing the button, the device starts time T1 ("time between short time and long time command") and waits. If the button is released again before T1 has elapsed, the device transmits a short time telegram. This telegram can be used to stop a running drive. A stationary drive rotates the slats by one level.
- If the button is kept depressed after T1 has elapsed, the device transmits a long time telegram and starts time T2 ("slat adjusting time").
- If the button is released within T2, the device sends another short time telegram. This function is used for adjusting the slats of a blind. The function permits stopping the slats in any position during their rotation.
The "slat adjusting time" should be chosen as required by the drive for a complete rotation of the slats. If the "slat adjusting time" is selected longer than the complete running time of the drive, a push button function is possible as well. This means that the drive is active only when the button is kept depressed.
- If the button is kept depressed longer than T2, the device transmits no further telegram. The drive remains on until the end position is reached.

i In this operation concept, the device will not transmit a telegram immediately after depressing one side of the rocker. This principle permits detecting a full-surface operation when the sensor is configured as a rocker.

Single and double-surface Venetian blind function

With an operating area as a rocker, the double-surface Venetian blind function is preset. This means that the device transmits a telegram for an upward movement, for example after an actuation of the left actuation point and a telegram for a downward movement after an actuation of the right actuation point.

In the separate buttons function, the device is preprogrammed for single-surface Venetian blind function. In this case, the device alternates between the directions of the long time telegram (TOGGLE) on each long actuation of the sensor. Several short time telegrams in succession have the same direction.

The parameter "Command on pressing the button" or "Command on pressing the rocker" on the parameter pages of the buttons or rockers defines the single-surface or double-surface Venetian blind principle. For the button function, the command issued on pressing the button can basically be selected at the user's discretion.

If the actuator can be controlled from several sensors, a faultless single-surface actuation requires that the long time objects of the device are interlinked. The device would otherwise not be able to detect that the actuator has been addressed from another sensor, in which case it would have to be actuated twice during the next use in order to produce the desired reaction.

Full-surface operation with Venetian blind function

When a rocker is configured for Venetian blind operation and if the operation concept "long – short or short" is used, the device needs some time at the beginning of each operation in order to distinguish between a short and a long operation. When full-surface operation is enabled, the device can make use of this time span to evaluate the otherwise invalid simultaneous actuation of both actuation points.

The push button sensor detects a full-surface operation of a rocker, if an operating area is depressed over a large area so that both actuation points of the rocker are actuated. When the device has detected a valid full-surface actuation, the operation LED flashes quickly at a rate of about 8 Hz for the duration of such actuation. Full-surface operation must have been detected before the first telegram has been transmitted by the Venetian blind function (short time or long time). If this is not so, even a full-surface operation will be interpreted as a wrong operation and not be executed.

Full-surface actuation is independent. It has a communication object of its own and can optionally be used for switching (ON, OFF, TOGGLE – toggling of the object value) or for scene recall without or with storage function. In the last case, a press on the full surface causes a scene to be recalled in less than a second. If the device is to send the telegram for storing a scene, full-

surface actuation must be maintained for more than five seconds. If full-surface actuation ends between the first and the fifth second, the device will not send any telegrams. If the status LEDs of the rocker are used as "button-press displays", they will light up for three seconds during transmission of the storage telegram.

- i Full-surface actuation cannot be configured in the push button functions. There it is possible to configure the single-surface principle, which also allows an operating area to be depressed at the centre or over a large area.

4.2.4.3.4 "Value transmitter" function

For each rocker or each button with the function set to "1-byte value transmitter" or "2-byte value transmitter", the ETS indicates a corresponding object. On the press of a button, the configured value or the value last stored internally by a value change (see below) will be transmitted to the bus. In case of the rocker function, different values can be configured or varied for both actuation points.

Value ranges

The "Function" parameter determines the value range used by the push button.

As a 1-byte value transmitter, the device can optionally transmit integers from 0 ... 255 or relative values within a range of 0 ... 100 % (e.g. as dimming value transmitter).

As a 2-byte value transmitter, the device can optionally transmit integers from 0 ... 65535, temperature values within a range of 0 ... 40 °C or brightness values from 0 ... 1500 lux.

For each of these ranges, the value that can be transmitted to the bus for each actuation of a rocker or button is configurable.

Adjustment by means of long button-press

If the value adjustment feature has been enabled in the ETS, the button must be kept depressed for more than 5 seconds in order to vary the current value of the value transmitter.

The value adjustment function continues to be active until the button is released again. In a value adjustment, the device distinguishes between the following options...

- The "Starting value in case of value adjustment" parameter defines the original starting value for the adjustment. Adjustment can begin from the value configured in the ETS, from the final value of the last adjustment cycle or from the current value of the communication object, with the last option not being available for the temperature and brightness value transmitter.
- The parameter "Direction of value adjustment" defines whether the values will always be increased ("upwards"), always reduced ("downwards") or alternately increased and reduced ("toggling").
- For the value transmitters 0 ... 255, 0 ... 100 % and 0 ... 65535, the "step width" by which the current value is to be changed during the value adjustment can be specified. In case of the temperature and the brightness value transmitter, the step width specifications (1 °C and 50 lux) are fixed.
- The parameter "Time between two telegrams" can be used in connection with the step width to define the time required to cycle through the full respective value range. This value defines the time span between two value transmissions.
- If, during the value adjustment, the device detects that the preset step width would result in the limits being exceeded with the next telegram, it adapts the step width once in such a way that the respective limit value is transmitted together with last telegram. Depending on the setting of the parameter "Value adjustment with overflow", the device stops the adjustment at this instance or inserts a pause consisting of two levels and then continues the adjustment beginning with the other limit value.

	Function	Lower numerical limit	Upper numerical limit
1-byte value transmitter	0...255	0	255
1-byte value transmitter	0...100 %	0 % (value = 0)	100 % (value = 255)
2-byte value transmitter	0...65535	0	65535
2-byte value transmitter	Temperature value	0 °C	40 °C
2-byte value transmitter	Brightness value	0 lux	1.500 lux

Value range limits for the different value transmitters

- i** During a value adjustment, the newly adjusted values are only in the volatile RAM memory of the extension module. Therefore, the stored values are replaced by the preset values programmed in the ETS when a reset of the push button sensor occurs (bus voltage failure or ETS programming).
- i** With the 1-byte value transmitter in the "Value transmitter 0...100 %" function, the step width of the adjustment will also be indicated in "%". If the starting value of the communication object is used, it may happen in this case during value adjustment that the value last received via the object must be rounded and adapted before a new value can be calculated on the basis of the step width and transmitted. Due to the computation procedure used, the new calculation of the value may be slightly inaccurate.

Value adjustment examples

Configuration example:

- Value transmitter 1-byte (all other value transmitters identical)
- Function = value transmitter 0...255
- Value configured in the ETS (0...255) = 227
- Step width (1...10) = 5
- Start on value adjustment = same as configured value
- Direction of value adjustment = toggling (alternating)
- Time between two telegrams = 0.5 s

Example 1: Value adjustment with overflow? = No

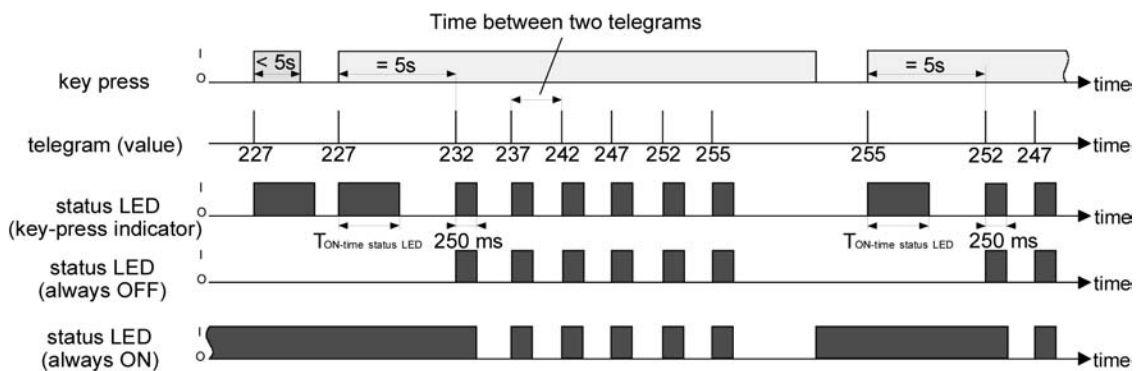

Figure 16: Example of value adjustment without value range overflow

Example 2: Value adjustment with overflow? = Yes

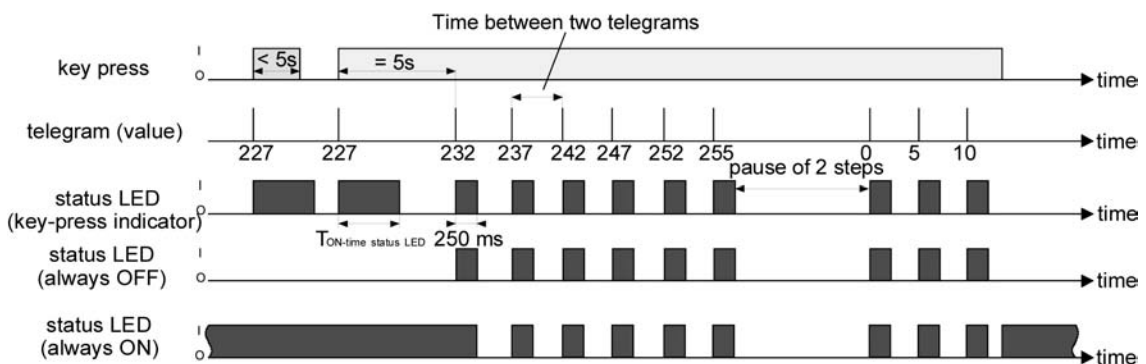

Figure 17: Example of value adjustment with value range overflow

4.2.4.3.5 Scene extension function

For each rocker or each button with the function set to "scene extension unit" the ETS indicates the "Function" parameter which distinguishes between the following settings...

- "Scene extension without store function",
- "Scene extension with storage function",
- "Recall internal scene without store function"
- "Recall internal scene with store function".

In the scene extension function, the device transmits a preset scene number (1...64) via a separate communication object to the bus after a button-press. This feature permits recalling scenes stored in other devices and also storing them, if the storage function is used.

The recall of an internal scene does not result in a telegram being transmitted to the bus. For this reason, the corresponding communication object is missing. This function can rather be used to recall – and with the storage function also to store – the up to 8 scenes stored internally in the device.

In the setting "... without store function", a button-press triggers the simple recall of a scene. If the status LED is configured as button-press display, it will be switched on for the configured ON time. A long button-press has no further or additional effect.

In the setting "... with storage function", the device monitors the length of the actuation. A button-press of less than a second results in a simple recall of the scene as mentioned above. If the status LED is configured as button-press display, it will be switched on for the configured ON time.

After a button-press of more than five seconds, the device generates a storage instruction. In the scene extension function, a storage telegram is in this case transmitted to the bus. If configured for the recall of an internal scene, the sensor will store the internal scene. The internal scene control module of the device will then request the current scene values for the actuator groups used from the bus.

An operation lasting between one and five seconds will be discarded as invalid.

The parameter "Scene number" specifies which of the maximum of 8 internal or 64 external scenes is to be used after a button-press. In case of the rocker function, two different scene numbers can be assigned.

4.2.4.3.6 "2-channel operation" function

In some situations it is desirable to control two different functions with only one operation and to transmit different telegrams, i.e. to operate two function channels at a time. This is possible with the "2-channel operation" function.

For both channels, the parameters "Function channel 1" and "Function channel 2" can be used to determine the communication object types to be used. The following types are available for selection...

- Switching (1 bit)
- Value transmitter 0 ... 255 (1-byte)
- Value transmitter 0 ... 100 % (1-byte)
- Temperature value transmitter (2 bytes)

The object value the device is to transmit on a button-press can be selected depending on the selected object type. The "Switching (1 bit)" type permits selecting whether an ON or an OFF telegram is to be transmitted or whether the object value is to be switched over (TOGGLE) and transmitted on the press of a button.

The configuration as "Value transmitter 0 ... 255 (1 byte)" or as "Value transmitter 0 ... 100 % (1 byte)" permits entering the object value freely within a range from 0 to 255 or from 0% to 100%. The "Temperature value transmitter (2 bytes)" permits selecting a temperature value between 0°C and 40°C.

In this case, the adjustment of the object value on a long button-press is not possible as the determination of the actuation length is needed for the adjustable operation concepts.

Unlike in the other rocker and button functions, the application software assigns the "Telegram acknowledge" function instead of the "Button-press display" function to the status LED. In this mode, the status LED lights up for approx. 250 ms with each telegram transmitted. Alternatively, the status LEDs can be configured independently.

Operation concept channel 1 or channel 2

In this operation concept, exactly one telegram will be transmitted on each press of a button.

- On a brief press the device transmits the telegram for channel 1.
- On a long press the device transmits the telegram for channel 2.

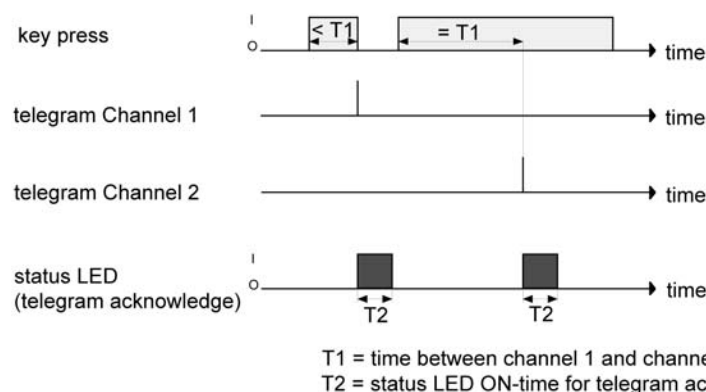

Figure 18: Example of operation concept "Channel 1 or Channel 2"

The time required for distinguishing between a short and a long operation is defined by the parameter "Time between channel 1 and channel 2". If the button is pressed for less than the configured time, only the telegram to channel 1 is transmitted. If the length of the button-press exceeds the time between channel 1 and channel 2, only the telegram to channel 2 will be transmitted. This concept provides the transmission of only one channel. To indicate that a

telegram has been transmitted, the status LED lights up for approx. 250 ms in the "Telegram acknowledge" setting.

In this operation concept, the device will not transmit a telegram immediately after the rocker has been depressed. This principle also permits the detection of full-surface operation. The settings that are possible with full-surface operation are described below.

Operation concept channel 1 and channel 2

With this operation concept, one or alternatively two telegrams can be transmitted on each button-press.

- On a brief press the device transmits the telegram for channel 1.
- A long press causes the device to transmit first the telegram for channel 1 and then the telegram for channel 2.

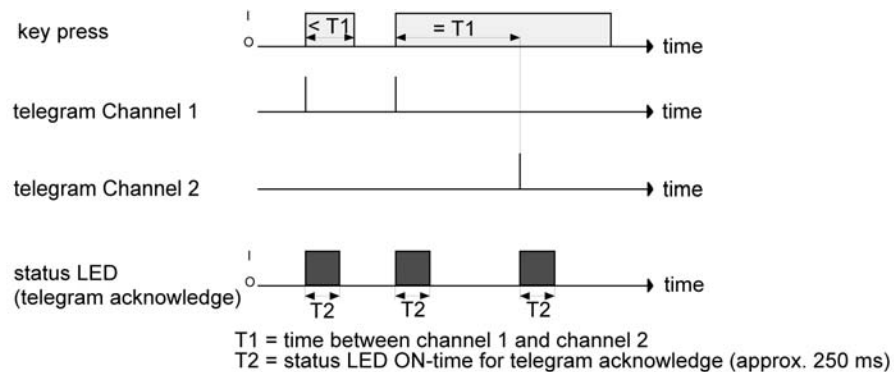

Figure 19: Example of operation concept "Channel 1 or Channel 2"

The time required for distinguishing between a short and a long operation is defined by the parameter "Time between channel 1 and channel 2". When a sensor area is actuated using this concept, the telegram is immediately sent to channel 1. If the button is held depressed for the configured time, the telegram for the second channel is transmitted as well. If the button is released before the time has elapsed, no further telegram will be transmitted. This operation concept, too, offers the parameterizable possibility of having the transmission of a telegram signalled by the status LED (setting "Telegram acknowledge").

Full-surface operation with 2-channel operation

When a rocker is programmed for 2-channel operation and if the operation concept "channel 1 or channel 2" is used, the device needs some time at the beginning of each operation in order to distinguish between a short and a long operation. When full-surface operation is enabled, the device can make use of this time span to evaluate the otherwise invalid simultaneous actuation of both actuation points.

The device detects a full-surface operation of a rocker, if an operating area is depressed over a large area so that both actuation points of the rocker are actuated.

When the device has detected a valid full-surface actuation, the operation LED flashes quickly at a rate of about 8 Hz for the duration of such actuation. The full-surface operation must have been detected before the first telegram has been transmitted by the 2-channel function. If this is not so, even a full-surface operation will be interpreted as a wrong operation and not be executed.

4.2.4.4 Status LED

Status LED

Each sensor area on the device has its own status LED. Depending on the configuration of the rockers or buttons, the possible LED functions available differ slightly.

Each status LED distinguishes the following options...

- Always OFF,
- always ON,
- Control via separate LED object,
- Operating mode display (KNX controller),
- Controller status indicator (activate controller extension!),
- Comparator without sign (1 byte),
- Comparator with sign (1 byte).

These options are always available even if the buttons have no function assigned.

If a function has been assigned to the rocker or button, the ETS displays moreover the option...

- Button-press display,

...which in the function "2-channel operation" is replaced by...

- Telegram acknowledgment

...ersetzt wird.

If the rocker or the button is used for switching or dimming, the following options can be selected in addition...

- Status display (switching object)
- Inverted status display (switching object)

...can be set.

If a button is used for the operation of a controller extension, the following options can be selected in addition...

- button function active / inactive indicator (only with presence button),
- setpoint value shift indicator (only with setpoint shift).

...can be set.

i Besides the functions that can be set separately for each status LED, all status LEDs are also used together with the operation LED for alarm signalling. If this is active, all LEDs of the device flash simultaneously. After deactivation of the alarm signalling, all LEDs will immediately return to the state corresponding to their configuration and communication objects.

i When the cleaning function is active, all the status LEDs flash synchronously at a frequency of approx. 1 Hz.

Status LED function "always OFF" or "always ON"

With these settings, the appropriate status LED is continuously switched on or off. When a value is adjusted (rocker or push-button function "Value transmitter"), a status LED switched off in normal operation can also indicate a value adjustment.

Function of the status LED "Button-press display" or "Telegram acknowledgement":

A status LED used as button-press display is switched on by the device each time the corresponding rocker or button is pressed. The parameter "ON time of status LEDs as actuation indicators" on the parameter page "General" specifies for how long the LED is switched on in common for all status LEDs. The status LED lights up when the rocker or button is pressed even if the telegram is transmitted by the device only when the button or rocker is released. With the function "2-channel operation" the option "Button-press display" is replaced by "Telegram acknowledge". In this case the status LED is illuminated when both channels are transmitted for about 250 ms each.

Function of the status LED "Control via separate LED object", "Status display", and "Inverted status display"

Each status LED can indicate the status of a separate LED communication object independently of the rocker or pushbutton configuration. Here the LED can be switched on or off statically via the received 1-bit object value, or also activated by flashing. Each status LED can indicate the state of a separate LED communication object independently of the rocker or pushbutton configuration. Here the LED can be switched on or off statically via the 1-bit object value received, or also activated as flashing.

Additionally, the status LEDs can be linked in the rocker or button functions "switching" and "dimming" also with the object used for switching and thus signal the current switching state of the actuator group.

Both for the status indication of the LED object and also for the status indication of the switching object it is possible to indicate or evaluate the inverted object value.

After a bus reset or after ETS programming, the value of the LED object is always "OFF".

Function of status LED as "operating mode display (KNX controller)"

For switching over between different modes of operation, new room temperature controller can make use of two communication objects of the 20.102 "HVAC-Mode" data type. One of these objects can switch over with normal priority between the "Comfort", "Standby", "Night", "Frost/heat protection" operating modes. The second object has a higher priority. It permits switching over between "Automatic", "Comfort", "Standby", "Night", "Frost/heat protection". Automatic means in this case that the object with the lower priority is active.

If a status LED is to indicate the operating mode, the communication object of the status LED must be linked with the matching object of the room temperature controller. The desired operating mode which the LED is to indicate can then be selected with the parameter "Status LED on with". The LED is then lit up when the corresponding operating mode has been activated at the controller.

After a bus reset or after ETS programming, the value of the LED object is always "0" (Automatic).

Function of status LED as "controller status display"

If a status LED is to indicate the status of a room temperature controller, the controller extension must have been activated on parameter page "General". The status LED is then internally linked directly with the 1-byte object "Controller status" of the controller extension. This object must then be linked via a group address with the corresponding communication object of the controller.

The object "Controller status" groups eight different information units in a bit-oriented way in a byte. For this reason it is important to select in the "Status LED on with" parameter which information is to be indicated, i.e. which bit is to be evaluated.

The following can be selected...

- Bit 0: Comfort mode
- Bit 1: Standby mode
- Bit 2: Night mode
- Bit 3: Frost/heat protection
- Bit 4: Controller disabled
- Bit 5: Heating / cooling (heating = 1 / cooling = 0)

- Bit 6: Controller inactive (dead zone operation)
- Bit 7: Frost alarm

Description of bit-oriented status messages of the room temperature controller (active = ON)

Comfort mode: Active if operating mode "Comfort" or a comfort extension is activated.

Standby mode: Active if the "Standby" operating mode is activated.

Night mode: Active if the "Night" operating mode is activated.

Frost/heat protection: Active if the "Frost/heat protection" operating mode is activated.

Controller disabled: Active if controller disable is activated (dew point mode).

Heating/cooling: Active if heating is activated and inactive if cooling is activated. (As a rule inactive with controller disabled.)

Controller inactive: Active with the "heating and cooling" operating mode when the measured room temperature lies within the dead zone. This status information is as a rule always "0" for the individual operating modes "heating" or "cooling"! (Inactive if controller is disabled.)

Frost alarm: Active if the measured room temperature reaches or drops below + 5 °C.

The communication object "Controller status" of the controller extension updates itself automatically after a reset of the device or after ETS programming, if the parameter "Value request from controller extension?" on parameter page "General" is set to "Yes". Updating is effected by means of a value read telegram to the room temperature controller. The thermostat must answer the request with a value return telegram. If the device does not receive the answer, the status LED remains off (object value "0"). In this case, the object must first be actively rewritten by the bus after a reset before a status information can be indicated by the LED.

This is also the case, when the "Value request from controller extension?" is set to "No".

Function of status LED as "comparator"

The status LED can indicate whether a configured comparison value is greater than, equal to or less than the 1-byte object value of the status object. This comparator can be used for unsigned (0 ... 255) or for signed integers (-128 ... 127). The data format of the comparison is defined by the function of the status LED.

The status LED lights up only if the comparison is "true".

i After a bus reset or after ETS programming, the value of the LED object is always "0".

4.2.4.5 Scene control

Introduction

The device can be used in two different ways as part of a scene control system...

- Each rocker or button can work as a scene extension. This feature makes it possible to recall or to store scenes which may be stored in other devices (see page 47).
- The device can independently store up to eight scenes with eight actuator groups. These internal scenes can be recalled or stored by the rockers or buttons (internal scene recall) and also by the communication object "scene extension".

In the following subsections the internal scene function will be dealt with in greater detail.

4.2.4.5.1 Scene definition and scene recall

If the internal scenes are to be used, the parameter "Scene function" on parameter page "Scenes" must be set to "Yes". When the scene function is activated, the ETS automatically renames the "Scenes" page "Scene data types".

The matching data types for the eight scene outputs must then be selected and adapted to the actuator groups used. The types "Switching", "Value (0 ... 255)" or "Value / blind position (0 ... 100 %)" can be selected. As a rule, Venetian blinds are controlled via two scene outputs. One output controls the blind height and the other one adjusts the slat position.

The ETS sets the corresponding communication objects and the parameters of the scene commands on the following parameter pages "Scene 1" to "Scene 8".

It is possible that the values for the individual scenes preset by the parameters are modified later on with the storage function (see page 55) when the system is in operation. If the application program is then loaded again with the ETS, these locally adapted values will normally be overwritten by the parameters. Due to the fact that it may take considerable efforts to readjust the values for all scenes in the system, the parameter "Overwrite scene values during ETS download ?" offers the possibility of retaining the scene values stored in operation without overwriting them.

The scene parameters can be set on the parameter page of each individual scene ("Scene 1 ... 8"). The setting options are the same for all 8 scenes.

These internal scenes can be recalled directly via the rockers or buttons (function "recall internal scene") and also by another bus device via the "Extension input" communication object. This 1 byte communication object supports the evaluation of up to 64 scene numbers. For this reason, it must be specified in ETS which of the external scene numbers (1 ... 64) is to recall the internal scene (1 ... 8). If the same scene number is listed for several internal scenes, it is always only the first of these scenes that will be activated (scene with the lowest scene number).

In some situations there may be the requirement that a group of actuators is not controlled by all, but only by certain scenes. A classroom, for instance, may require open blinds for the "Welcome" and "Break" scenes, closed blinds in the "PC presentation" scene and no change in the "Discussion" scene. In this example, the parameter "Permit transmission ?" can be set to "No" for the "Discussion" scene. The scene output is then deactivated during the corresponding scene.

The parameter "Transmit delay" permits entering an individual waiting time for each scene output. This transmit delay can be used in different situations...

- When the actuators participating in a scene transmit status messages automatically or when several scene buttons are used to increase the number of channels within the scenes, the recall of a scene may result for a short time in high bus loading. The transmit delay helps to reduce the bus load at the time of scene recall.
- Sometimes, it is desirable that an action is started only after another action has ended. This can be for instance the illumination which is to shut off only after the blinds/shutters have been raised.

The transmit delay can be set separately for each scene output. The transmit delay defines the time delay between the individual telegrams during a scene recall. The setting specifies how much time must pass after the first scene telegram before the second is transmitted. After transmission of the second scene telegram, the configured time must again pass before the third is transmitted. The delay continues as follows for each additional scene telegram. The transmit delay for the first scene telegram starts immediately after the scene has been recalled. The transmit delay between telegrams can also be deactivated (setting "0"). The telegrams are then transmitted at the shortest possible time interval. In this case, however, the order of the telegrams transmitted can deviate from the numbering of the scene outputs.

- i** When a new scene recall (also with the same scene number) occurs during a current scene recall - even in consideration of the pertaining transmit delays - the scene processing started first will be aborted and the newly received scene number will be processed. A running scene is also aborted when a scene is being stored!
- i** During a scene recall - even if delayed - the sensor surfaces of the device are normally operational.

4.2.4.5.2 Storing scenes

For each output of a scene, the user can define a corresponding scene value in the ETS which is then transmitted to the bus during a scene recall. During the ongoing operation of the system it may be necessary to adapt these preset values and to save the adapted values in the device. This can be ensured by the storage function of the scene control.

The value storage function for the corresponding scene number is enabled with the parameter "Permit storing ?" ("Yes") or disabled ("No"). When the storage function is disabled, the object value of the corresponding output is not sampled during storage.

A scene storage process can be initiated in two different ways...

- by a long press on a rocker or button of an operating area configured as "scene extension"
- by a storage telegram to the extension object.

During a storage process, the device reads the current object values of the connected actuators. This is carried out by means of eight read telegrams (ValueRead) addressed to the devices in the scene which return their own value (ValueResponse) as a reaction to the request. The returned values are received by the device and taken over permanently into the scene memory. Per scene output, the device waits one second for a response. If no answer is received during this time, the value for this scene output remains unchanged and the device scans the next output.

In order to enable the device to read the object value of the actuator addressed when a scene is stored, the read flag of the corresponding actuator object must be set. This should be done only for one actuator out of an actuator group so that the value response is unequivocal. The stored values overwrite those programmed into the device with the ETS.

The storage process will always be executed completely by the device and cannot not be aborted before it has ended. Recalling scenes in the course of a storage process is not possible, the operating areas of the device remaining nevertheless normally operational.

4.2.4.6 Disabling function

Configuration

With the 1-bit communication object "Button disabling", the sensor surfaces of the device can be partly or completely disabled. During a disable, the rockers or buttons can also temporarily execute other functions.

An active disable applies only to the functions of the rockers or buttons. The functions of the status LED, scene function and the alarm signalling are not affected by the disabling function. The disabling function and the pertaining parameters and communication objects are enabled if the parameter "Disabling function ?" is set to "Yes" on the "Disabling" parameter page.

You can parameterize the polarity of the disabling object. In case of polarity inversion (disabled = 0 / enabled = 1), the disabling function is not activated immediately after a bus reset or after ETS programming (object value = "0"). There must first be an object update "0" until the disabling function will be activated.

Telegram updates from "0" to "0" or from "1" to "1" on the "button disabling" object remain without effect.

Configuring the reaction at the beginning and end of a disable

If the disabling function is used, the reaction of the device on activation and deactivation of the disabling function can be preset separately in the parameterisation (parameter "Reaction of pushbutton sensor at the beginning / end of disabling"). In this connection it is irrelevant which of the control surfaces is influenced and possibly also locked by disabling. The device always shows the configured behaviour.

The disabling function must have been enabled in advance.

- Set the parameter "Reaction of pushbutton sensor at the beginning / end of disabling" to "No reaction".

The device shows no reaction at the beginning and end of disabling. The sensor only adopts the state as provided for by the "Behaviour during active disabling".

- Set the parameter "Reaction of pushbutton sensor at the beginning / end of disabling" to "Internal scene recall scene 1 ...8".

The device opens one of the up to 8 internal scenes. Scene storage is not possible.

- Set the parameter "Reaction of pushbutton sensor at the beginning / end of disabling" to "Reaction as button >> X << / >> Y << when pressed / released".

The device executes the function assigned to any "target button" in non-disabled state. Target buttons are operating buttons of the device which may be configured for rocker or for button operation. The target buttons are configured separately for the beginning (X) of for the end (Y) of disabling. Both buttons of a rocker are treated as two separate buttons. The action configured for the respective target button is executed. If the target button is configured in such a way that it has no function or does not transmit a telegram on pressing or releasing of the button, then there is also no reaction to disabling or to re-enabling. If the selected target button is part of a configured rocker, the behaviour preset for the respective rocker side (rocker X.1 or X.2) will be used. The telegrams are transmitted to the bus via the required communication object of the target button.

The following table shows all possible telegram reactions of the device with respect to the target button function.

Function of >>target button<<	Reaction "as >>target button<< on pressing"	Reaction "as >>target button<< on releasing"
Switching / toggling	Switching telegram	Switching telegram
Dimming	Switching telegram	No telegram
Venetian blind	Move telegram	No telegram
Scene extension	Scene recall telegram	No telegram
1-byte value transmitter	Value telegram	No telegram
2-byte value transmitter	Value telegram	No telegram
Temperature value transmitter	Temperature value telegram	No telegram
Brightness value transmitter	Brightness value telegram	No telegram
2-channel operation Channel 1: 1-bit object type	Switching telegram	No telegram
2-channel operation Channel 1: 1-byte object type	Value telegram	No telegram
2-channel operation Channel 1: 2-byte object type	Temperature value telegram	No telegram
Controller extension Operating mode switchover	Operating mode telegram	No telegram
Controller extension Motion detection	Presence telegram	No telegram
Controller extension Setpoint shift	Level value telegram	No telegram
No function	No telegram	No telegram

Telegram reactions of the device with respect to the target push-button function

- Set the parameter "Reaction of pushbutton sensor at the beginning / end of disabling" to "Reaction as disabling function 1 / 2 when pressed / released".

The device executes the function assigned to either of the two "virtual" disabling functions. The disabling functions are internal button functions with independent communication objects and independent parameters. Except for the status LED, the setting possibilities available for disabling function 1 and disabling function 2 are the same as for the buttons. The respective configuration of the predefined disabling function will be executed. If no function or no telegram is configuration in the disabling function on pressing or releasing of a button, then there is also no reaction to disabling or to re-enabling.

The table shows all possible telegram reactions of the device depending on the configuration of the disabling function for this setting, too.

The telegrams are transmitted to the bus via the required communication object of the disabling function.

Configuring the reaction during a disable

Irrespective of the behaviour shown by the device at the beginning or at the end of disabling, the sensor areas can be separately influenced during disabling.

The disabling function must have been enabled in advance.

- Set the parameter "Behaviour during active disabling" to "all buttons without function".

The device is then completely disabled during disabling. Operation of the sensor areas has no effect. The status LEDs of the disabled buttons are without function (no button-press display either). Only the "Always ON" or "Always OFF" state remains unaffected by the disabling function.

- Set the parameter "Behaviour during active disabling" to "all buttons behave like". Continue to configure the parameters "During disable, all left / right buttons behave like" to the required button number or disabling function.

All buttons behave as defined in the parameters for the two specified reference buttons of the device. Different or identical reference buttons can be configured separately for all the left and right operating buttons. The two "virtual" disabling functions of the device can also be configured as a reference button.

The telegrams are transmitted to the bus via the communication objects of the specified reference buttons. The status LEDs of the reference buttons are controlled according to their function. The status LEDs of the disabled buttons are without function (no button-press display either). Only the "Always ON" or "Always OFF" state remains unaffected by the disabling function.

- Set the parameter "Behaviour during active disabling" to "Individual buttons without function". The buttons that will be disabled are defined on the parameter page "Disable - Button selection" page.

Only the individually specified buttons are locked during disabling. The other control buttons remain unaffected by disabling. The status LEDs of the disabled buttons are without function (no button-press display either). Only the "Always ON" or "Always OFF" state remains unaffected by the disabling function.

- Set the parameter "Behaviour during active disabling" to "Individual buttons behave like". The buttons that will be disabled are defined on the parameter page "Disable - Button selection" page. Continue to configure the parameters "During disable, all left / right buttons behave like" to the required button number or disabling function.

Only the individually specified buttons behave as defined in the parameters of the two specified reference buttons of the device. Different or identical reference buttons can be configured separately for all the left and right operating buttons. The two "virtual" disabling functions of the device can also be configured as a reference button. The buttons that will be disabled are defined in the parameters on the "Disable - buttons selection" page.

The telegrams are transmitted to the bus via the communication objects of the specified reference buttons. The status LEDs of the reference buttons are controlled according to their function. The status LEDs of the disabled buttons are without function (no button-press display either). Only the "Always ON" or "Always OFF" state remains unaffected by the disabling function.

- i** If a button evaluation is taking place at the time of activation / deactivation of a disabling function, this function is aborted immediately and with it also the pertaining button function. It is first necessary to release all buttons before a new button function can be executed if so permitted by the state of disabling.

4.2.4.7 Controller extension

4.2.4.7.1 Connection to room temperature controller

Function

The controller extension can be used to control a KNX room temperature controller. The controller extension function is enabled with the parameter "Controller extension" on the "General" page

The controller extension itself is not involved in the regulating process. With it, the user can operate the single-room regulation from different places in the room. It can also be used to adjust central heating control units which are located, for instance, in a distribution box.

Typical KNX room temperature controllers generally offer different ways of influencing or visualising the room temperature control...

- Switching over between different modes of operation (e.g. "Comfort", "Night" ...) with different setpoint temperatures assigned to each mode by the thermostat.
- Signalling the presence of a person in a room. The signalling may also be combined with a configured switchover in the mode of operation.
- Readjustment of the setpoint temperature in steps which are referred in each case to the configured setpoint temperature of the current mode of operation (basic setpoint shift).

The device permits, through operation of its sensor areas, complete control of a room temperature controller by changing the operating mode, by presetting the presence situation or by readjusting the setpoint shift. For this purpose, the buttons selected as extension operation buttons must be configured for the "Controller extension" function.

- i** It should be noted that an extension operation is possible only if one control surface is configured as a button and if the controller extension function has been enabled on the "General" page. In all other cases, controller extension operating does not function.

In addition, the device can – independent of the controller extension function – indicate the state of one or more room temperature controllers with the status LEDs of the rockers or buttons. This feature permits the indication of operating modes or the bit-oriented evaluation of different status objects of controllers. In case of the controller extension functions "Setpoint shift" or "Presence function", the status LEDs can also signal the state of the corresponding functions directly.

Communication objects

The controller extension can work properly only if all extension objects are linked with the objects of the same function in the room temperature controller. The controller extension with the objects exists only once in the device (indication in the object name "Controller extension"). All button functions configured for the controller extension act on the objects belonging to the extension.

Objects with the same function can be linked together using identical group addresses, meaning that multiple controller extensions can affect one main controller.

The communication objects "Operating mode selection", "Forced operating mode switchover", "Presence button", "Current setpoint shift" and "Controller status" of the controller extension update themselves automatically after a reset or after ETS programming, if the parameter

"Value request from controller extension?" on the "General" parameter page is set to "Yes". Updating is effected by means of a ValueRead telegram to the room temperature controller. This must answer the request with a ValueResponse telegram. If the device does not receive all or some of the answers, the affected objects are initialised with "0". In this case, the objects must first be actively rewritten by the bus after a reset. This is also the case, when the "Value request from controller extension?" is set to "No".

4.2.4.7.2 Button function "Operating mode switchover"

Switchover of the controller operating mode can be effected in accordance with the standard function block for room temperature controllers defined in the KNX handbook with two 1-byte communication objects. The operating mode can be switched over with the normal and with the forced objects. The "Operating mode selection" object offers a selection between the following operating modes...

- Comfort mode
- Standby mode
- Night mode
- Frost/heat protection mode

The "Forced operating mode switch over" communication object has a higher priority. It permits forced switching between the following modes of operation...

- Auto (normal operating mode switchover)
- Comfort mode
- Standby mode
- Night mode
- Frost/heat protection mode

The operating mode transmitted to the bus on sensor area operation of the controller extension is defined by the parameter "Operating mode on pressing the button". Depending on the configured functionality, it is possible that ...

- Either one of the above-mentioned modes is activated (single selection) on the press of the button,
- Or the device is switched over between two or three modes (multiple selection).

i Notes on multiple selection:

In order to ensure that a change-over from one operating mode to another works properly even from different locations, the operating mode objects of the controller and those of all controller extensions must be interlinked and have their "Write" flag set. In the objects concerned, this flag is set by default

By checking the linked operating mode switchover object, the controller extension knows which of the possible operating modes is active. Based on this information, the device switches over into the next operating mode in sequence when a sensor area is operated. In the event that none of the possible operating modes is active, the next operating mode in the sequence is set to "Comfort" mode (in case of "Standby - >Night" to "Standby" mode). As far as switching over between the forced operating modes and "Auto" is concerned, the device switches into the "Auto" operating mode when none of the configured operating modes is active.

i It is not possible to program a reaction on release of the button. A long button-press is evaluated in the same way as short one and switches into the corresponding operating mode insofar as this is acceptable for the controller.

i If a status LED is to indicate the current operating mode, the status LED function must be programmed for "Operating mode indication" and its status object be linked with the corresponding group address for operating mode change-over with normal or high priority.

4.2.4.7.3 Button function "Presence button"

All buttons with their function set to "Presence button" are internally linked with the "Presence button" object of the controller extension. The parameter "Presence function on pressing the button" defines the object value transmitted to the bus on operating a sensor area. In order to ensure that the object value transmitted in the "Presence TOGGLE" setting is always the correct one, the presence object of the room temperature controller and the "Presence button" objects of the controller extensions must be interlinked and have their "Write" flag set. In the extension objects concerned, this flag is set by default.

It is not possible to program a reaction on release of the button. A long button-press is evaluated in the same way as short one and switches into the corresponding presence mode insofar as this is acceptable for the controller.

The status LED of the presence button can indicate both the presence status (setting "Button function indication active / inactive") and also the actuation of the button. In addition, the usual setting possibilities of the status LED are configurable as well .

4.2.4.7.4 Button function "Setpoint shift"

The setpoint shift is another available function of the controller extension. It makes use of two 1-byte communication objects with data point type 6.010 (integer with sign). This extension function allows shifting of the basic setpoint for the temperature on a room temperature controller by pressing a button. The control on the extension is as a rule the same as a control on the main controller.

A button configured as a setpoint shifting button reduces or increases the setpoint shift value on each press by one step respectively. The direction of the value adjustment is defined by the parameter "Setpoint shift on pressing the button". Releasing the button and a long press have no other functions.

Communication with the main controller point:

In order to enable the device to effect a setpoint shift in a room temperature controller, the controller must have input and output objects for setpoint shifting. In this case, the output object of the controller must be linked with the input object of the extension unit and the input object of the controller must be linked with the output object of the extension via an independent group address (see chapter 4.2.4.7.1. Connection to room temperature controller).

All objects are of the same data point type and have the same value range. A setpoint shift is interpreted by count values: a shift in positive direction is expressed by positive values whereas a shift in negative direction is represented by negative object values. An object value of "0" means that no setpoint shift has been activated.

Via the "Current setpoint shift" object of the controller extensions, which is linked with the room temperature controller, the extensions are enabled to determine the current setpoint shift position. Starting from the value of the communication object, each operation of a sensor area on an extension will adjust the setpoint in the corresponding direction by one count value level. Each time the setpoint is adjusted, the new shift is transmitted to the room temperature controller via the "Controller extension setpoint value specification" object of the controller extension. The controller itself checks the received value for the minimum and maximum temperature limits (see controller documentation) and adjusts the new setpoint shift if the values are valid. When the new count value is accepted as valid, the controller transfers this value to its output object for setpoint shifting and retransmits the value to the extension as positive feedback.

Due to the standard data point type used as the output and input object of the controller extension and the weighting of the individual level by the controller itself, each extension unit is able to determine whether a shift took place, in which direction it took place and by how many levels the setpoint was shifted. This requires that the communication objects are connected on all controller extensions and the controller.

The information for the step value as feedback from the controller enables the extension to continue the adjustment anytime at the right point. The extension units can likewise react to a reset of the setpoint shifting function by the controller.

The status LED of a sensor area for setpoint shifting can indicate both the setpoint shifting status (setting "Setpoint value shift indicator") and also the actuation. In addition, the usual setting possibilities of the status LED are configurable as well .

For setpoint shifting status indication, the controller makes use of the step count value which is transmitted to the extension and evaluated for switching of the status LED. The "Status LED" parameter defines the switching behaviour: The LED can be permanently off and light up only after a shift has been detected (setting "ON, ..."). As an alternative, the LED can be permanently on and go out only after a shift has been detected (setting "OFF, ..."). It can also be distinguished whether the LED is ON or OFF only if...

- there has been shifting at all,
- only a positive shift has been detected,
- only a negative shift has been detected.

4.2.4.8 Room temperature measurement

Temperature detection and measured value formation

The pushbutton offers the option of measuring the room temperature and making the measured value available to other KNX subscribers in an appropriate form. Room temperature measurement can be used if the "Room temperature measurement" parameter on the "General" parameter page is configured to "Enabled".

The push button features an integrated temperature sensor. This temperature sensor can be used to measure the ambient temperature and forward it to a room temperature controller via a 2-byte object. Alternatively, the temperature measurement can be supplemented by means of an external wired sensor. This wired temperature sensor is connected to the device directly and supplements the temperature value of the internal sensor in cases in which room temperature measurements in a single location are of no use. The "Temperature detection" parameter on the "Room temperature measurement" parameter page specifies the sensors that are used to detect the room temperature. The following settings are possible...

- "internal temperature sensor"
Only the temperature sensor integrated in the push button is activated. Thus, the actual temperature value is determined only locally on the device.

- "Internal and wired sensor"
With this setting, the internal as well as the wired temperature sensor is active. The wired sensor (accessories) must then be connected to the pushbutton. The temperature measured by the wired remote sensor is provided as an isolated measured temperature value in the 2-byte object "Wired temperature sensor" and can be read out by other bus subscribers as required.
When evaluating, the real actual temperature is made up from the two respective measured temperature values. The weighting of the temperature values is defined by the "Creation of measuring value internal against wired" parameter. Depending on the different locations of the sensors and non-uniform heat distribution inside the room, it is thus possible to adjust the actual temperature measurement. Often, those temperature sensors that are subject to negative external influences (for example, unfavourable location because of exposure to sun or heater or door / window directly next to it) are weighted less heavily.

Example: The push button has been installed next to the entrance door (internal sensor). An additional wired temperature sensor has been mounted on an inner wall in the middle of the room below the ceiling.

Internal sensor: 21.5 °C

Wired sensor: 22.3 °C

Determination of measured value: 30 % to 70 %

$$\rightarrow T_{\text{Result internal}} = T_{\text{internal}} \cdot 0.3 = 6.45 \text{ °C},$$

$$\rightarrow T_{\text{Result external}} = T_{\text{wired}} = 22.3 \text{ °C} \cdot 0.7 = 15.61 \text{ °C}$$

$$\rightarrow T_{\text{Result actual}} = T_{\text{Result internal}} + T_{\text{Result wired}} = \underline{22.06 \text{ °C}}$$

Temperature calibration of the measurement values

In some cases during room temperature measurement, it may be necessary to adjust the temperature values of the internal and the wired sensor. Adjustment becomes necessary, for example, if the temperature measured by the sensors stays permanently below or above the actual temperature in the vicinity of the sensor. To determine the temperature deviation, the actual room temperature should be detected with a reference measurement using a calibrated temperature measuring device.

The parameter "Internal sensor adjustment..." and "Wired sensor adjustment..." on the parameter page "Room temperature measurement" can be used to configure the positive

(temperature increase, factors: 1 ... 127) or negative (temperature decrease, factors -128... -1) temperature calibration in levels of 0.1 K. Thus, the calibration is made only once statically and is the same for all operating modes of the controller.

- i** The measured value has to be increased, if the value measured by the sensor lies below the actual room temperature. The measured value has to be decreased, if the value measured by the sensor lies above the actual room temperature.
- i** The pushbutton sensor always transmits the calibrated temperature value to the controller. When determining the measured value using the internal and wired sensor, the two adjusted values are used to calculate the actual value.

Transmission of room temperature

The determined room temperature can be transmitted to the bus via the 2-byte object "Measured room temperature". The parameter "Transmission after room temperature change by..." on the parameter page "Room temperature control" specifies the temperature value by which the actual value has to change in order to have the actual room temperature value transmitted automatically via the object. Possible temperature value changes lie within a range of 0.1 K and 25.5 K. If "0" is selected, the automatic transmission of the room temperature.

In addition, the actual value can be transmitted periodically. The "Cyclical transmission of the room temperature" parameter determines the cycle time (1 to 255 minutes). The value "0" will deactivate the periodical transmission of the room temperature value.

Setting the "Read" flag on the "Measured room temperature" object makes it possible to read out the current actual value at any time over the bus. It has to be pointed out that with deactivated periodical transmission and deactivated automatic transmission, no more room temperature telegrams will be transmitted in case of a change.

Following the return of bus voltage or reprogramming via the ETS the object value will be updated according to the determined room temperature value and transmitted on the bus. In case a temperature value telegram has not been received from the external sensor via the object "External temperature sensor" when evaluating an external temperature sensor, only the value provided by the internal sensor will be transmitted. For this reason, the external temperature sensor should always transmit the current value after a reset.

4.2.4.9 Cleaning function

Activating the Cleaning function suppresses the sensor area evaluation for 60 s (blocking time) to prevent unintentional actions from being executed when the glass surface is being cleaned. All the sensor areas of the device are blocked when the cleaning function is active. In addition, all the status LEDs flash synchronously at a frequency of approx. 1 Hz. When the blocking time has elapsed, the device automatically returns to normal operation.

The cleaning function is started using a "1" telegram to the "Cleaning function" object. Additional "1" telegrams during the blocking time start this time again. "0" telegrams to the object do not product a reaction.

- i** The telegram to activate the cleaning function can also be triggered directly by a sensor area of the local device. For this, the appropriate communication object of the button or rocker function must be connected to the communication object of the cleaning function. When 2-channel operation is used, the cleaning function can also be activated using channel 2. Here, it is useful that no button is blocked only for the cleaning function.
- i** Cleaning with a lightly moistened, lint-free cloth, possibly with a mild glass cleaner. Do not use sharp objects or abrasive cleaning agents, e.g. scouring powder.

4.2.4.10 Alarm signal

The device permits signalling of an alarm which might be, for instance, a burglar or a fire alarm from a KNX central alarm unit. An alarm is signalled by all status LEDs and of the operation LED of the device flashing synchronously. This alarm indication can be separately enabled with the parameter "Alarm signalling indication" on parameter page "Alarm signalling" so that it can be used.

When alarm signalling is enabled, the ETS displays the communication object "Alarm signalling" and further alarm function parameters. The alarm signalling object is used as an input for activating or deactivating alarm signal displaying. The polarity of the object can be selected. When the object value corresponds to the "Alarm" condition, all status LEDs and the operation LED are always flashing with a frequency of approx. 2 Hz. If there is an alarm, the behaviour of the operating LED as configured in the ETS and the status LED for normal operation have no significance. The LEDs adopt their originally configured behaviour only after the alarm signalling function has been deactivated. Changes of the state of the LEDs during an alarm - if they are controlled by separate LED objects or if they signal push-button functions - are internally stored and recovered at the end of the alarm.

Apart from the possibility of deactivating an alarm signal via the alarm object, it can also be deactivated locally by a button-press on the device itself. The "Reset alarm signalling by a button-press?" parameter defines the button response during an alarm...

- If this parameter is set to "Yes", active alarm signal displaying can be deactivated by a button-press on the device. This button-press does not cause the configured function of the pressed button to be executed. Only after the next button-press will the configuration of the button be evaluated and a telegram be transmitted to the bus, if applicable.
- If "No" has been selected, alarm signalling can only be deactivated via the alarm signalling object. A button-press will always directly execute the configured button function.

If alarm signalling can be deactivated by a button-press, the parameter "Acknowledge alarm signalling by" defines whether an additional alarm acknowledge telegram is to be transmitted to the bus via the separate object "Alarm signalling acknowledge" after triggering by this button-press.

Such an acknowledge telegram can, for instance, be sent via a 'listening' group address to the "Alarm message" objects of other bus subscribers in order to reset the alarm status there as well. Attention must be paid during resetting of an alarm to the selectable polarity of the acknowledge object.

- i** Notes on the polarity of the alarm object: If the setting is "Alarm when OFF and alarm reset when ON", the alarm object must be actively written by the bus with "0" to activate the alarm after a reset or after programming with the ETS.
- i** An active alarm signal is not stored so that the alarm signalling is generally deactivated after a device reset or after programming with the ETS.

4.2.5 Delivery state

For as long as the device has not yet been programmed with application data by means of the ETS, the operation LED flashes at a slow rate (approx. 0.75 Hz). When a sensor area is pressed, the appropriate status LED lights up briefly (button-press display). This condition persists until the application is programmed into the device.

By slow flashing of its operation LED (approx. 0.75 Hz), the device can also indicate that a wrong application has been programmed into its memory. Applications are non run-capable if they are not intended for use with the device in the ETS product database. Attention must also be paid to the fact that the device variant is compatible with the one in the project (e.g. 4x version created in the ETS project and also installed).

The operation LED flashes slowly also if the application program has been removed by the ETS. In both cases, the device is not operational.

4.2.6 Parameters

Description	Values	Comment
□↳ General		
Transmit delay after reset or bus voltage return	Yes	<p>After a reset (e.g. after loading of an application program or the physical address or after return of bus voltage), the device can automatically transmit telegrams for the room temperature controller extension functions. In case of the controller extension, the device attempts to retrieve values from the room temperature controller by means of read telegrams in order to update the object states. In case of the room temperature measurement, the device transmits the current room temperature after a reset to the bus.</p> <p>If there are still other bus subscribers besides the device transmitting telegrams immediately after a reset, it may be useful to activate the transmit delay for automatically transmitting objects in order to reduce the bus load.</p> <p>When transmit delay is activated (setting: "Yes"), the device computes the delay time from its device ID in the physical address. It then waits 30 seconds maximum before transmitting telegrams.</p>
	No	
Light period of status LED for button-press display	1 sec	<p>This parameter defines the switch-on time the status LED is lit up to indicate actuation. The setting concerns all status LEDs whose function is set to "Button-press display".</p>
	2 sec	
	3 sec	
	4 sec	
	5 sec	
Function of operation LED	always OFF	<p>This parameter defines the function of the operation LED.</p> <p>The operation LED is always off.</p>
	always ON	<p>The operation LED is always on, for instance, as orientation lighting.</p>
	Control via object	<p>The operation LED is controlled by a separate communication object.</p>
	flashing	<p>The operation LED flashes permanently with a frequency of about 0.75 Hz.</p> <p>Besides the function set here, the operation LED can display different states by means of other flashing rates. These comprise Programming mode, the confirmation of full-surface actuation</p>

		or the message that an application has not been loaded.
Control of the operation LED via the object value	<p>1 = LED static ON / 0 = LED static OFF</p> <p>1 = LED static OFF / 0 = LED static ON</p> <p>1 = LED flashes / 0 = LED static OFF</p> <p>1 = LED static OFF / 0 = LED flashes</p>	<p>If the "Function of the operation LED" is set to "Control via object", then the telegram polarity of the 1-bit object "Operation LED" can be specified at this point.</p> <p>The LED can be switched on or off statically. In addition, the received switching telegram can be evaluated in such a way that the LED flashes.</p>
Controller extension	<p>enabled</p> <p>Disabled</p>	<p>This parameter enables the communication objects and the parameter page for the room temperature controller extension. In addition, at least one rocker must be divided into two buttons to permit full use of the controller extension features.</p>
Value request from controller extension?	<p>Yes</p> <p>No</p>	<p>In order to enable the device to transmit the correct values after a press on the buttons representing the controller extension, the "Operating mode selection", "Forced operating mode switchover", "Active setpoint shift" and "Presence button" communication objects can transmit read requests after a reset.</p> <p>This parameter is only visible, if the parameter "Controller extension" is set to "enabled".</p>
Room temperature measurement	<p>enabled</p> <p>Disabled</p>	<p>The room temperature measurement of the device can be enabled at this point. When the function is enabled, the parameter page "Room temperature measurement" and additional objects become visible.</p>
Object for cleaning function	<p>enabled</p> <p>Disabled</p>	<p>This parameter enables the communication object for the cleaning function.</p>
☐↔ Operation concept		
Operation concept of buttons 1 and 2	Rocker function (rocker 1)	For each sensor area, the user can specify independently whether it is to be used as a rocker with a common basic function or as two different buttons with
(The same parameters	Button function	

are available for the other sensor areas.)

completely independent functions. Depending on this setting, the ETS displays different communication objects and parameter pages.

Button evaluation

(The same parameters are available for the other sensor areas.)

If the operation concept of a sensor area is configured as "push button function", this parameter can be used to specify whether single-surface or double-surface operation should be implemented.

Single area operation (only as button 1)

In single-surface operation, neighbouring sensor areas are evaluated as a single "large" button. Single-surface operation is simultaneous operation of neighbouring sensor areas (left / right). In this setting, the button with the even button number of the neighbouring button pair (e.g. button 2) is inactive in parameterisation.

Double-area operation (as buttons 1 + 2)

In double-surface operation, neighbouring sensor areas are divided up so as to be independent and thus two separate buttons.

Rocker 1 (buttons 1/2) (only if "Function of buttons 1 and 2 = as one rocker (rocker 1)!")

Function

Switching
Dimming
Venetian blind
Value transmitter 1-byte
2-byte value transmitter
Scene extension
2-channel operation

This parameter is used to define the basic function of the rocker. Depending on this choice, the ETS displays different communication objects and parameters for this rocker.

The following parameters are only valid for the rocker function "Switching"...

Command on pressing left rocker

No reaction
ON
OFF
TOGGLE

These parameters specify the reaction when the left rocker is pressed or released.

Command on releasing left rocker

No reaction
ON
OFF
TOGGLE

Command on pressing right rocker

No reaction
ON
OFF
TOGGLE

These parameters specify the reaction when the right rocker is pressed or released.

Command on releasing right rocker

No reaction
ON

OFF
TOGGLE

The following parameters are only valid for the rocker function "Dimming"...

Command on pressing left rocker	No reaction Brighter (ON) Darker (OFF) Brighter / darker (TOGGLE) Brighter (TOGGLE) Darker (TOGGLE)	This parameter defines the reaction when the left rocker is pressed. If the push button sensor is to toggle on a brief press, the corresponding switching objects of other sensors with the same function must be linked with one another. In the "Brighter/darker (TOGGLE)" setting, the dimming objects must be interlinked as well so that the push button sensor can send the correct telegram on the next button-press.
Command on pressing right rocker	No reaction Brighter (ON) Darker (OFF) Brighter / darker (TOGGLE) Brighter (TOGGLE) Darker (TOGGLE)	This parameter defines the reaction when the right rocker is pressed. If the push button sensor is to toggle on a brief press, the corresponding switching objects of other sensors with the same function must be linked with one another. In the "Brighter/darker (TOGGLE)" setting, the dimming objects must be interlinked as well so that the push button sensor can send the correct telegram on the next button-press.
Time between switching and dimming, left rocker (100 ... 50000 x 1 ms)	100 ... 400 ... 50000	This parameter defines how long the left rocker must be pressed for the push button sensor to send a dimming telegram.
Time between switching and dimming, right rocker (100 ... 50000 x 1 ms)	100 ... 400 ... 50000	This parameter defines how long the right rocker must be pressed for the push button sensor to send a dimming telegram.
Advanced parameters	Activated Deactivated	When the advanced parameters are activated, the ETS shows the following parameters.
Advanced parameters activated...		
Increase brightness by	1.5 % 3 % 6 % 12.5 % 25 %	This parameter sets the relative dimming level when the brightness is increased. On each button-press, the brightness is changed at maximum by the configured step width. Especially with smaller dimming levels it

	50 % 100 %	is advisable for the push button sensor to repeat the dimming telegrams automatically (see "telegram repetition").
Reduce brightness by	1.5 % 3 % 6 % 12.5 % 25 % 50 % 100 %	This parameter sets the relative dimming level when the brightness is reduced. On each button-press, the brightness is changed at maximum by the configured step width. Especially with smaller dimming levels it is advisable for the push button sensor to repeat the dimming telegrams automatically (see "telegram repetition").
Transmit stop telegram?	Yes No	On "Yes" the push button sensor transmits a telegram for stopping the dimming process when the rocker is released. When the push button sensor transmits telegrams for dimming in smaller levels, the stop telegram is generally not needed.
Telegram repeat?	Yes No	This parameter can be used to activate telegram repetition for dimming. With the button held down, the push button sensor will then transmit the relative dimming telegrams (in the programmed step width) until the button is released.
Time between two telegrams	200 ms 300 ms 400 ms 500 ms 750 ms 1 sec 2 s	This parameter defines the interval at which the dimming telegrams are automatically repeated in the telegram repetition mode. This parameter is visible only if "Telegram repetition = Yes"!
Full-surface operation	enabled Disabled	When the full-surface operation is enabled, the ETS shows the following parameters.
Function for full-surface operation	Switching Scene recall without store function Scene recall with storage function	In case of full-surface operation, this parameter defines the function that is to be used. The ETS shows the corresponding communication object and the other parameters. If the push button sensor is to recall a scene with storage function by full-surface actuation, it will make a distinction between a brief press (less than 1 s), a sustained press (longer than 5 s) and an invalid button-press

		(between 1 s and 5 s). A brief press recalls the scene, a sustained press stores a scene and an invalid full-surface operation is ignored. This parameter is visible only if "Full-surface actuation = enabled"!
Command for full-surface operation	ON OFF TOGGLE	This parameter defines the value of the transmitted telegram when a full-surface operation has been sensed. "TOGGLE" changes over the current object value. This parameter is visible only if "Full-surface actuation = enabled"!
Scene number (1 ... 64)	1, 2, ..., 64	This parameter defines the scene number which is to be transmitted to the bus after a scene recall or during storage of a scene. This parameter is visible only if "Full-surface actuation = enabled"!
The following parameters are only valid for the rocker function "Venetian blind"...		
Command on pressing rocker	Left rocker: UP / Right rocker: DOWN Left rocker: DOWN / Right rocker: UP Left rocker: TOGGLE / Right rocker: TOGGLE	This parameter defines the running direction of a drive after a button-press. If the setting is "TOGGLE", the direction is changed after each long time command. If several push buttons are to control the same drive, the long time objects of the push buttons must be interlinked for a correct change of the running direction.
Operation concept	short – long – short long – short short – long long – short or short	For Venetian blind control, four different operation concepts can be selected. For these concepts, the ETS shows further parameters.
Time between short and long time command, left rocker (1 ... 3000 x 100 ms)	1 ... 4 ... 3000	This parameter sets the time after which the long time operation will be evaluated on pressing the top (or left-hand) button of the rocker. This parameter is not visible with "Operation concept = long – short"!
Time between short and long time command, right rocker (1 ... 3000 x 100 ms)	1 ... 4 ... 3000	This parameter sets the time after which the long time operation will be evaluated on pressing the bottom (or right-hand) button of the rocker.

		This parameter is not visible with "Operation concept = long – short"!
Slat adjusting time, left rocker (0 ... 3000 x 100 ms)	0 ... 5 ... 3000	Time during which a transmitted long time telegram can be terminated by releasing the left button of the rocker (short time). This function serves to adjust the slats of a blind. This parameter is not visible with "Operation concept = long – short"!
Slat adjusting time, right rocker (0 ... 3000 x 100 ms)	0 ... 5 ... 3000	Time during which a transmitted long time telegram can be terminated by releasing the right button of the rocker (short time). This function serves to adjust the slats of a blind. This parameter is not visible with "Operation concept = long – short"!
Full-surface operation	enabled Disabled	When the full-surface operation is enabled, the ETS shows the following parameters. Full-surface operation can only be programmed if "Operation concept = long – short or short"!
Function for full-surface operation	Switching Scene recall without store function Scene recall with storage function	In case of full-surface operation, this parameter defines the function that is to be used. The ETS shows the corresponding communication object and the other parameters. If the push button sensor is to recall a scene with storage function by full-surface actuation, it will make a distinction between a brief press (less than 1 s), a sustained press (longer than 5 s) and an invalid button-press (between 1 s and 5 s). A brief press recalls the scene, a sustained press stores a scene and an invalid full-surface operation is ignored. This parameter is visible only if "Full-surface actuation = enabled"!
Command for full-surface operation	ON OFF TOGGLE	This parameter defines the value of the transmitted telegram when a full-surface operation has been sensed. "TOGGLE" changes over the current object value. This parameter is visible only if "Full-surface actuation = enabled"!

Scene number (1 ... 64) 1, 2, ..., 64

This parameter defines the scene number which is to be transmitted to the bus after a scene recall or during storage of a scene.

This parameter is visible only if "Full-surface actuation = enabled"!

The following parameters are only valid for the rocker function "Value transmitter 1-byte"...

Function	<p>Left rocker / right, no function</p> <p>Left rocker: 0 ... 255 / Right rocker: 0 ... 255</p> <p>Left rocker: 0 ... 100 % / Right rocker: 0 ... 100 %</p> <p>Left rocker: 0 ... 255 / Right rocker: No function</p> <p>Left rocker: 0 ... 100 % / Right rocker: No function</p> <p>Left rocker: No function / right rocker: 0 ... 255</p> <p>Left rocker: No function / right rocker: 0 ... 100 %</p>	<p>A rocker configured as "Value transmitter 1 byte" permits selecting whether the values to be transmitted are interpreted as integers from 0 to 255 or as a percentage from 0 % to 100 %. The following parameters and their settings depend on this distinction.</p>
Value, left rocker (0 ... 255)	0...255	<p>This parameter defines the object value when the left rocker is pressed. Visible only if "Function = 0...255"!</p>
Value, right rocker (0 ... 255)	0...255	<p>This parameter defines the object value when the right rocker is pressed. Visible only if "Function = 0...255"!</p>
Value, left rocker (0 ... 100 %)	0...100	<p>This parameter defines the object value when the left rocker is pressed. Visible only if "Function = 0...100 %"!</p>
Value, right rocker (0 ... 100 %)	0...100	<p>This parameter defines the object value when the right rocker is pressed. Visible only if "Function = 0...100 %"!</p>
Value adjustment by long button-press	<p>enabled</p> <p>Disabled</p>	<p>If value adjustment by long button-press is enabled, the ETS shows further parameters. Value adjustment begins, when the button is held down for more than 5 s. In</p>

		this case, the respective status LED flashes as a sign that a new telegram has been transmitted.
Starting value in case of value adjustment	<p>Same as configured value</p> <p>Same as value after last adjustment</p> <p>Same as value from communication object</p>	<p>Value adjustment can begin with different starting values.</p> <p>After each long press, the pushbutton sensor always starts with the value configured in the ETS.</p> <p>After a long press, the pushbutton sensor starts with the value transmitted by itself or by another device with this group address as the last value.</p> <p>After a long press, the pushbutton sensor starts with the value transmitted by itself or by another device with this group address as the last value. This parameter is only visible if "Value adjustment by long button-press = enabled"!</p>
Direction of value adjustment	<p>Upwards</p> <p>Downwards</p> <p>Toggling (alternating)</p>	<p>With a long press, the push button sensor can either vary the values always in the same direction or it stores the direction of the last adjustment and reverses it on the next button-press. This parameter is only visible if "Value adjustment by long button-press = enabled"!</p>
Step width (1 ... 15)	1...15	<p>In a value adjustment, the pushbutton sensor determines the new telegram value from the previous value and the preset step width. If the value falls below the lower limit of the adjustment range (0 or 0 %) or if it exceeds the upper limit (255 or 100%), the sensor adapts the step width of the last step automatically. This parameter is only visible if "Value adjustment by long button-press = enabled"!</p>
Time between two telegrams	<p>0.5 sec</p> <p>1 sec</p> <p>2 sec</p> <p>3 sec</p>	<p>In a value adjustment, the pushbutton sensor determines the new telegram value from the previous value and the preset step width. If the value falls below the lower limit of the adjustment range (0 or 0 %) or if it exceeds the upper limit (255 or 100%), the sensor adapts the step width of the last step automatically. This parameter is only visible if "Value adjustment by long button-press =</p>

enabled"!

Value adjustment with overflow	<p>Yes</p> <p>No</p>	<p>If value adjustment is to be effected without overflow (setting "No") and if the pushbutton sensor reaches the lower limit of the adjustment range (0 or 0 %) or the upper limit (255 or 100 %) during value adjustment, the adjustment will be stopped automatically by the sensor. If the value adjustment with overflow is programmed (setting "Yes") and if the push button sensor reaches the lower or the upper limit, it will transmit the value of this range limit and then add a pause the duration of which corresponds to two levels. Thereafter, the push button sensor transmits a telegram with the value of the other range limit and continues the value adjustment in the same direction.</p>
--------------------------------	-----------------------------	--

The following parameters are only valid for the rocker function "Value transmitter 2-byte"...

Function	<p>Temperature value transmitter</p> <p>Brightness value transmitter</p> <p>Value transmitter (0 ... 65535)</p>	<p>A rocker configured as "Value transmitter 1 byte" permits selecting whether the values to be transmitted are to be interpreted as temperature values (0 °C to 40 °C), as brightness values (0 lux to 1500 lux) or as integers (0 to 65535). The following parameters and their settings depend on this selection.</p>
Temperature value (0 ... 40 °C) Left rocker	0... 20 ...40	<p>This parameter defines the object value when the left rocker is pressed. This is only visible if "Function = Temperature value transmitter"!</p>
Temperature value (0 ... 40 °C) Right rocker	0... 20 ...40	<p>This parameter defines the object value when the right rocker is pressed. This is only visible if "Function = Temperature value transmitter"!</p>
Brightness value Left rocker	0, 50, ... 300 ... 1450, 1500 lux	<p>This parameter defines the object value when the left rocker is pressed. This is only visible if "Function = Brightness value transmitter"!</p>
Brightness value Right rocker	0, 50, ... 300 ... 1450, 1500 lux	<p>This parameter defines the object value when the right rocker is pressed. This is only visible if "Function =</p>

		Brightness value transmitter"!
Value (0 ... 65535) Left rocker	0 ... 65535	This parameter defines the object value when the left rocker is pressed. This is only visible if "Function = Value transmitter (0 ... 65535)"!
Value (0 ... 65535) Right rocker	0 ... 65535	This parameter defines the object value when the right rocker is pressed. This is only visible if "Function = Value transmitter (0 ... 65535)"!
Value adjustment by long button-press	enabled Disabled	If value adjustment by long button-press is enabled, the ETS shows further parameters. Value adjustment begins, when the button is held down for more than 5 s. In this case, the respective status LED flashes as a sign that a new telegram has been transmitted.
Starting value in case of value adjustment	Same as configured value	Value adjustment can begin with different starting values. After each long press, the pushbutton sensor always starts with the value configured in the ETS.
	Same as value after last adjustment	After a long press, the pushbutton sensor starts with the value transmitted by itself or by another device with this group address as the last value.
	Same as value from communication object	After a long press, the pushbutton sensor starts with the value transmitted by itself or by another device with this group address as the last value. This setting selectable only if "Functionality = Value transmitter (0...65535)! This parameter is only visible if "Value adjustment by long button-press = enabled"!
Direction of value adjustment	Upwards Downwards Toggling (alternating)	With a long press, the push button sensor can either vary the values always in the same direction or it stores the direction of the last adjustment and reverses it on the next button-press. This parameter is only visible if "Value adjustment by long button-press = enabled"!

Step width	1 °C	For temperature values, the step width of the adjustment is fixed to 1°C. This parameter is only visible if "Function = Temperature value transmitter" and "Value adjustment by long button-press = enabled"!
Step width	50 lux	For brightness values, the step width of the adjustment is fixed to 50 lux. This parameter is only visible if "Function = Brightness value transmitter" and "Value adjustment by long button-press = enabled"!
Step width	1 2 5 10 20 50 75 100 200 500 750 1000	This parameter sets the step width of the value adjustment for the 2-byte value transmitter. This parameter is only visible if "Function = Value transmitter (0 ... 65535)" and "Value adjustment by long button-press = enabled"!
Time between two telegrams	0.5 sec 1 sec 2 sec 3 sec	This parameter defines the interval at which the push button sensor transmits new telegrams during a value adjustment. This parameter is only visible if "Value adjustment by long button-press = enabled"!
Value adjustment with overflow	Yes No	If value adjustment is to be effected without overflow (setting "No") and if the pushbutton sensor reaches the lower limit of the adjustment range (0°C, 0 lux, 0) or the upper limit (40°C, 1500 lux, 65535) during value adjustment, the adjustment will be stopped automatically by the sensor. If the value adjustment with overflow is programmed (setting "Yes") and if the push-button sensor reaches the lower or the upper limit, it will transmit the value of this range limit and then add a pause the duration of which corresponds to two levels. Thereafter, the push button sensor transmits a telegram with the value of the other range limits and continues the value adjustment in the same direction.

The following parameters are only valid for the rocker function "Scene extension"...

Function	Scene extension without storage function	This parameter defines the functionality of the extension. If the push button sensor is used as a scene extension, the scenes can either be stored in one or in several other KNX/EIB devices (e.g. light scene push button sensor). During a scene recall or in a storage function, the push button sensor transmits a telegram with the respective scene number via the extension object of the rocker. During the recall of an internal scene, a scene stored internally in the push button sensor is recalled or stored again. In this case, the sensor transmits no telegram to the bus via a scene extension object. For this setting, the internal scene function must be enabled.
	Scene extension with storage function	
	Recall of internal scene extension without storage function	
	Recall of internal scene with storage function	
Scene number (1 ... 64) Left rocker	1...64	In accordance with the KNX standard, objects with data type 18.001 "Scene Control" can recall or store up to 64 scenes by their numbers. The parameter defines the scene number to be transmitted when a left button is pressed.
Scene number (1 ... 64) Right rocker	1...64	In accordance with the KNX standard, objects with data type 18.001 "Scene Control" can recall or store up to 64 scenes by their numbers. The parameter defines the scene number to be transmitted when a right button is pressed.
Scene number (1 ... 8) Left rocker	1...8	This parameter defines the number of the internal scene which is recalled or stored when a left button is pressed.
Scene number (1 ... 8) Right rocker	1...8	This parameter defines the number of the internal scene which is recalled or stored when a right button is pressed.

The following parameters are only valid for the rocker function "2-channel operation"...

Operation concept	Channel 1 or channel 2	This parameter defines the 2-channel operation concept. If the setting "Channel 1 or channel 2" is selected, the
	Channel 1 and channel 2	

		push button sensor decides dependent on the button-press duration which of the channels will be used. If the setting "Channel 1 and channel 2" is selected, the push button sensor transmits only the telegram of channel 1 on a short button-press and both telegrams on a sustained button-press.
Function channel 1 (2)	No function Switching (1 bit) Value transmitter 0 ... 255 (1-byte) Value transmitter 0 ... 100 % (1-byte) Temperature value transmitter (2-bytes)	This parameter defines the channel function and specifies which other parameters and which communication object are to be displayed for channel 1 (2).
Command of button for channel 1 (2) Left rocker	ON OFF TOGGLE	This parameter defines the object value transmitted to the bus, when the left-hand rocker is pressed. This is only visible if "Function channel 1 (2) = Switching (1 bit)"!
Command of button for channel 1 (2) Right rocker	ON OFF TOGGLE	This parameter defines the object value transmitted to the bus, when the right-hand rocker is pressed. This is only visible if "Function channel 1 (2) = Switching (1 bit)"!
Value of the button for Channel 1 (2) Left rocker (0...255)	0...255	This parameter defines the object value transmitted to the bus, when the left-hand rocker is pressed. It is only visible if "Function channel 1 (2) = Value transmitter 0...255 (1 byte)"!
Value of the button for Channel 1 (2) Right rocker (0...255)	0...255	This parameter defines the object value transmitted to the bus, when the right-hand rocker is pressed. It is only visible if "Function channel 1 (2) = Value transmitter 0...255 (1 byte)"!
Value of the button for Channel 1 (2) Left rocker (0 ... 100 %)	0...100	This parameter defines the object value transmitted to the bus, when the left-hand rocker is pressed. It is only visible if "Function channel 1 (2) = Value transmitter 0...100 % (1-byte)"!
Value of the button for Channel 1 (2)	0...100	This parameter defines the object value transmitted to the bus, when the right-

Right rocker (0 ... 100 %)		hand rocker is pressed. It is only visible if "Function channel 1 (2) = Value transmitter 0...100 % (1-byte)"!
Temperature value of the button for channel 1 (2) Left rocker (0 ... 40 °C)	0...40	This parameter defines the temperature value transmitted to the bus when the left-hand rocker is pressed. It is only visible if "Function channel 1 (2) = Temperature value transmitter (2 bytes)"!
Temperature value of the button for channel 1 (2) Right rocker (0 ... 40 °C)	0...40	This parameter defines the temperature value transmitted to the bus when the right-hand rocker is pressed. It is only visible if "Function channel 1 (2) = Temperature value transmitter (2 bytes)"!
Time between channel 1 and channel 2 Left rocker (1 ... 255 x 100 ms)	0...30...255	Depending on the selected operation concept, this parameter defines the interval at which the push button transmits the telegram for channel 1 and the telegram for channel 2 when the left side of the rocker is pressed.
Time between channel 1 and channel 2 Right rocker (1 ... 255 x 100 ms)	0...30...255	Depending on the selected operation concept, this parameter defines the interval at which the push button transmits the telegram for channel 1 and the telegram for channel 2 when the right side of the rocker is pressed.
Full-surface operation	enabled Disabled	When the full-surface operation is enabled, the ETS shows the following parameters. Full-surface operation can only be programmed if "Operation concept = Channel 1 or channel 2"!
Function for full-surface operation	Switching Scene recall without store function Scene recall with storage function	In case of full-surface operation, this parameter defines the function that is to be used. The ETS shows the corresponding communication object and the other parameters. If the push button sensor is to recall a scene with storage function by full-surface actuation, it will make a distinction between a brief press (less than 1 s), a sustained press (longer than 5 s) and an invalid button-press

(between 1 s and 5 s). A brief press recalls the scene, a sustained press stores a scene and an invalid full-surface operation is ignored. This parameter is visible only if "Full-surface actuation = enabled"!

Command for full-surface operation	ON OFF TOGGLE	This parameter defines the value of the transmitted telegram when a full-surface operation has been sensed. "TOGGLE" changes over the current object value. This parameter is visible only if "Full-surface actuation = enabled"!
------------------------------------	----------------------------	---

Scene number (1 ... 64)	1, 2, ..., 64	This parameter defines the scene number which is to be transmitted to the bus after a scene recall or during storage of a scene. This parameter is visible only if "Full-surface actuation = enabled"!
-------------------------	---------------	--

☐↵ Rocker 2 (Buttons 3/4) ... Rocker n, see Rocker 1!

☐↵ Button 1 (only if "Function of buttons 1 and 2 = as separate buttons"!)

Function	No function Switching Dimming Venetian blind Value transmitter 1-byte 2-byte value transmitter Scene extension 2-channel operation Controller extension *	This parameter defines the basic function of the button. Depending on this setting, the ETS displays different communication objects and parameters for this button.
----------	--	--

*: Must have been enabled under "General"!

The following parameters are only valid for the push button function "Switching"...

Command on pressing the button	No reaction ON OFF TOGGLE	These parameters specify the reaction when the button is pressed or released.
Command on releasing the button	No reaction ON OFF TOGGLE	

The following parameters are only valid for the push button function "Dimming"...

Command on pressing the button	No reaction Brighter (ON) Darker (OFF) Brighter / darker (TOGGLE) Brighter (TOGGLE) Darker (TOGGLE)	This parameter defines the reaction when the button is pressed. If the push button sensor is to toggle on a brief press, the corresponding switching objects of other sensors with the same function must be linked with
--------------------------------	---	--

		one another. In the "Brighter/darker (TOGGLE)" setting, the dimming objects must be interlinked as well so that the push button sensor can send the correct telegram on the next button-press.
Time between switching and dimming (100 ... 50000 x 1 ms)	100 ... 400 ... 50000	This parameter defines how long the button must be pressed for the push button sensor to transmit a dimming telegram.
Advanced parameters	Activated Deactivated	When the advanced parameters are activated, the ETS shows the following parameters.
Advanced parameters activated...		
Increase brightness by	1.5 % 3 % 6 % 12.5 % 25 % 50 % 100 %	This parameter sets the relative dimming level when the brightness is increased. On each button-press, the brightness is changed at maximum by the configured step width. Especially with smaller dimming levels it is advisable for the push button sensor to repeat the dimming telegrams automatically (see "telegram repetition").
Reduce brightness by	1.5 % 3 % 6 % 12.5 % 25 % 50 % 100 %	This parameter sets the relative dimming level when the brightness is reduced. On each button-press, the brightness is changed at maximum by the configured step width. Especially with smaller dimming levels it is advisable for the push button sensor to repeat the dimming telegrams automatically (see "telegram repetition").
Transmit stop telegram?	Yes No	On "Yes" the push button sensor transmits a telegram for stopping the dimming process when the rocker is released. When the push button sensor transmits telegrams for dimming in smaller levels, the stop telegram is generally not needed.
Telegram repeat?	Yes No	This parameter can be used to activate telegram repetition for dimming. With the button held down, the push button sensor will then transmit the relative

dimming telegrams (in the programmed step width) until the button is released.

Time between two telegrams	200 ms 300 ms 400 ms 500 ms 750 ms 1 sec 2 s	This parameter defines the interval at which the dimming telegrams are automatically repeated in the telegram repetition mode. This parameter is visible only if "Telegram repetition = Yes"!
----------------------------	---	--

The following parameters are only valid for the push button function "Venetian blind"...

Command on pressing the button	DOWN UP TOGGLE	This parameter defines the running direction of a drive after a button-press. If the setting is "TOGGLE", the direction is changed after each long time command. If several push buttons are to control the same drive, the long time objects of the push buttons must be interlinked for a correct change of the running direction.
--------------------------------	-----------------------------	--

Operation concept	short – long – short long – short short – long long – short or short	For Venetian blind control, four different operation concepts can be selected. For these concepts, the ETS shows further parameters.
-------------------	--	--

Time between short-time and long-time command (1 ... 3000 x 100 ms)	1 ... 4 ... 3000	This parameter sets the time after which the long time operation will be evaluated on pressing the top (or left-hand) button of the rocker. This parameter is not visible with "Operation concept = long – short"!
--	-------------------------	---

Slat adjusting time (0 ... 3000 x 100 ms)	0 ... 5 ... 3000	Time during which a transmitted long time telegram can be terminated by releasing the top (or left-hand) button of the rocker (short time). This function serves to adjust the slats of a blind. This parameter is not visible with "Operation concept = long – short"!
--	-------------------------	--

The following parameters are only valid for the push-button function "value transmitter 1 byte"...

Function	Value transmitter 0 ... 255 Value transmitter 0 ... 100 %	A button configured as "Value transmitter 1 byte" permits selecting whether the values to be transmitted are interpreted as integers from 0 to 255 or as a percentage from 0 % to 100 %. The following parameters and their settings
----------	--	--

		depend on this distinction.
Value (0 ... 255)	0...255	This parameter defines the object value when the button is pressed. Visible only if "Function = 0...255"!
Value (0 ... 100 %)	0...100	This parameter defines the object value when the button is pressed. Visible only if "Function = 0...100 %"!
Value adjustment by long button-press	enabled Disabled	If value adjustment by long button-press is enabled, the ETS shows further parameters. Value adjustment begins, when the button is held down for more than 5 s. In this case, the respective status LED flashes as a sign that a new telegram has been transmitted.
Starting value in case of value adjustment		Value adjustment can begin with different starting values.
	Same as configured value	After each long press, the pushbutton sensor always starts with the value configured in the ETS.
	Same as value after last adjustment	After a long press, the pushbutton sensor starts with the value transmitted by itself or by another device with this group address as the last value.
	Same as value from communication object	After a long press, the pushbutton sensor starts with the value transmitted by itself or by another device with this group address as the last value. This parameter is only visible if "Value adjustment by long button-press = enabled"!
Direction of value adjustment	Upwards	With a long press, the push button sensor can either vary the values always in the same direction or it stores the direction of the last adjustment and reverses it on the next button-press. This parameter is only visible if "Value adjustment by long button-press = enabled"!
	Downwards	
	Toggling (alternating)	
Step width (1 ... 15)	1...15	In a value adjustment, the pushbutton sensor determines the new telegram value from the previous value and the preset step width. If the value falls below

		the lower limit of the adjustment range (0 or 0 %) or if it exceeds the upper limit (255 or 100%), the sensor adapts the step width of the last step automatically. This parameter is only visible if "Value adjustment by long button-press = enabled"!
Time between two telegrams	0.5 sec 1 sec 2 sec 3 sec	In a value adjustment, the pushbutton sensor determines the new telegram value from the previous value and the preset step width. If the value falls below the lower limit of the adjustment range (0 or 0 %) or if it exceeds the upper limit (255 or 100%), the sensor adapts the step width of the last step automatically. This parameter is only visible if "Value adjustment by long button-press = enabled"!
Value adjustment with overflow	Yes No	If value adjustment is to be effected without overflow (setting "No") and if the pushbutton sensor reaches the lower limit of the adjustment range (0 or 0 %) or the upper limit (255 or 100 %) during value adjustment, the adjustment will be stopped automatically by the sensor. If the value adjustment with overflow is programmed (setting "Yes") and if the push button sensor reaches the lower or the upper limit, it will transmit the value of this range limit and then add a pause the duration of which corresponds to two levels. Thereafter, the push button sensor transmits a telegram with the value of the other range limit and continues the value adjustment in the same direction.

The following parameters are only valid for the push-button function "value transmitter 2 byte"...

Function	Temperature value transmitter Brightness value transmitter Value transmitter (0 ... 65535)	A button configured as "Value transmitter 1 byte" permits selecting whether the values to be transmitted are to be interpreted as temperature values (0 °C to 40 °C), as brightness values (0 lux to 1500 lux) or as integers (0 to 65535). The following parameters and their settings depend on this selection.
Temperature value (0 ... 40 °C)	0... 20 ...40	This parameter defines the object value when the button is pressed. This is only visible if "Function = Temperature value transmitter"!

Brightness value	0, 50, ... 300 ... 1450, 1500 lux	This parameter defines the object value when the button is pressed. This is only visible if "Function = Brightness value transmitter"!
Value (0 ... 65535)	0 ... 65535	This parameter defines the object value when the button is pressed. This is only visible if "Function = Value transmitter (0 ... 65535)"!
Value adjustment by long button-press	enabled Disabled	If value adjustment by long button-press is enabled, the ETS shows further parameters. Value adjustment begins, when the button is held down for more than 5 s. In this case, the respective status LED flashes as a sign that a new telegram has been transmitted.
Starting value in case of value adjustment	Same as configured value Same as value after last adjustment Same as value from communication object	Value adjustment can begin with different starting values. After each long press, the pushbutton sensor always starts with the value configured in the ETS. After a long press, the pushbutton sensor starts with the value transmitted by itself or by another device with this group address as the last value. After a long press, the pushbutton sensor starts with the value transmitted by itself or by another device with this group address as the last value. This setting selectable only if "Function = Value transmitter (0...65535)"! This parameter is only visible if "Value adjustment by long button-press = enabled"!
Direction of value adjustment	Upwards Downwards Toggling (alternating)	With a long press, the push button sensor can either vary the values always in the same direction or it stores the direction of the last adjustment and reverses it on the next button-press. This parameter is only visible if "Value adjustment by long button-press = enabled"!
Step width	1 °C	

		For temperature values, the step width of the adjustment is fixed to 1°C. This parameter is only visible if "Function = Temperature value transmitter" and "Value adjustment by long button-press = enabled"!
Step width	50 lux	For brightness values, the step width of the adjustment is fixed to 50 lux. This parameter is only visible if "Function = Brightness value transmitter" and "Value adjustment by long button-press = enabled"!
Step width	1 2 5 10 20 50 75 100 200 500 750 1000	This parameter sets the step width of the value adjustment for the 2-byte value transmitter. This parameter is only visible if "Function = Temperature value transmitter" and "Value adjustment by long button-press = enabled"!
Time between two telegrams	0.5 sec 1 sec 2 sec 3 sec	This parameter defines the interval at which the push button sensor transmits new telegrams during a value adjustment. This parameter is only visible if "Value adjustment by long button-press = enabled"!
Value adjustment with overflow	Yes No	If value adjustment is to be effected without overflow (setting "No") and if the pushbutton sensor reaches the lower limit of the adjustment range (0°C, 0 lux, 0) or the upper limit (40°C, 1500 lux, 65535) during value adjustment, the adjustment will be stopped automatically by the sensor. If the value adjustment with overflow is programmed (setting "Yes") and if the push-button sensor reaches the lower or the upper limit, it will transmit the value of this range limit and then add a pause the duration of which corresponds to two levels. Thereafter, the push button sensor transmits a telegram with the value of the other range limits and continues the value adjustment in the same direction.

The following parameters are only valid for the push button function "scene extension"...

Function	Scene extension without storage function	This parameter defines the functionality of the extension. If the push button sensor is used as a scene extension, the scenes can either be stored in one or in several other KNX/EIB devices (e.g. light scene push button sensor). During a scene recall or in a storage function, the push button sensor transmits a telegram with the respective scene number via the extension object of the button. During the recall of an internal scene, a scene stored internally in the push button sensor is recalled or stored again. In this case, the sensor transmits no telegram to the bus via a scene extension object. For this setting, the internal scene function must be enabled.
	Scene extension with storage function	
	Recall of internal scene extension without storage function	
	Recall of internal scene with storage function	
Scene number (1 ... 64)	1...64	In accordance with the KNX standard, objects with data type 18.001 "Scene Control" can recall or store up to 64 scenes by their numbers. The parameter defines the scene number to be transmitted when the button is pressed.
Scene number (1 ... 8)	1...8	This parameter defines the number of the internal scene which is recalled or stored when a button is pressed.

The following parameters are only valid for the push button function "2-channel operation"...

Operation concept	Channel 1 or channel 2	This parameter defines the 2-channel operation concept. If the setting "Channel 1 or channel 2" is selected, the push button sensor decides dependent on the button-press duration which of the channels will be used. If the setting "Channel 1 and channel 2" is selected, the push button sensor transmits only the telegram of channel 1 on a short button-press and both telegrams on a sustained button-press.
	Channel 1 and channel 2	
Function channel 1 (2)	No function Switching (1 bit) Value transmitter 0 ... 255 (1-byte)	This parameter defines the channel function and specifies which other parameters and which communication object are to be displayed for channel 1

	Value transmitter 0 ... 100 % (1-byte) Temperature value transmitter (2-bytes)	(2).
Command of button for channel 1 (2)	ON OFF TOGGLE	This parameter defines the object value transmitted to the bus when the button is pressed. This is only visible if "Function channel 1 (2) = Switching (1 bit)"!
Value of the button for Channel 1 (2) (0 ... 255)	0...255	This parameter defines the object value transmitted to the bus when the button is pressed. It is only visible if "Function channel 1 (2) = Value transmitter 0...255 (1 byte)"!
Value of the button for Channel 1 (2) (0 ... 100 %)	0...100	This parameter defines the object value transmitted to the bus when the button is pressed. It is only visible if "Function channel 1 (2) = Value transmitter 0...100 % (1 byte)"!
Temperature value of the button for channel 1 (2) (0 ... 40 °C)	0...40	This parameter defines the temperature value transmitted to the bus when the button is pressed. It is only visible if "Function channel 1 (2) = Temperature value transmitter (2 bytes)"!
Time between channel 1 and channel 2 (1 ... 255 x 100 ms)	0...30...255	Depending on the selected operation concept, this parameter defines the interval at which the push button transmits the telegram for channel 1 and the telegram for channel 2 when the button is pressed.

The following parameters are only valid for the push button function "Controller extension"...

Function	Operating mode switch-over	A controller extension can optionally switch over the operating mode with normal or high priority, change the presence state or change the current room temperature value. With regard to the setting of this parameter, the ETS shows further parameters.
	Forced oper. mode switchover	
	Presence button	
	Setpoint shift	
	Comfort mode	If the controller extension is to change over the operating mode of the room

Operating mode when the following button is pressed	Standby mode	temperature controller with normal priority, the extension can – when operated – either switch on a defined operating mode or change over between different operating modes.		
	Night mode			
	Frost/heat protection mode			
	Comfort mode -> Standby mode ->			
	Comfort mode -> Night mode ->			
	Standby mode -> Night mode ->			
	Comfort mode -> Standby mode -> Night mode ->			
Forced operating mode when the following button is pressed	Auto (Normal operating mode change-over)	If the controller extension is to change over the operating mode of the room temperature controller with high priority, the extension can – when actuated – either enable the change-over with normal priority (auto), switch on a defined operating mode with a high priority or change over between different operating modes. In order for this change to work properly, the controller extension should request the current state of the extension objects after a reset or after re-programming (set parameter under "General" to "Value request from controller extension = Yes"). This parameter is only visible if "Function = forced operating mode switchover"!		
	Comfort mode			
	Standby mode			
	Night mode			
	Frost/heat protection mode			
	Comfort mode -> Standby mode ->			
	Comfort mode -> Night mode ->			
	Standby mode -> Night mode ->			
	Comfort mode -> Standby mode -> Night mode ->			
	Auto -> Comfort mode ->			
	Auto -> Standby mode ->			
	Presence function when the following button is pressed		Presence OFF	On pressing a key, the controller extension can switch the presence state of the room temperature controller either on or off in a defined way or change over between both states ("Presence TOGGLE"). In order for this change-over to work properly, the controller extension should
			Presence ON	
	Presence TOGGLE			

request the current state of the extension objects after a reset or after re-programming (set parameter under "General" to "Value request from controller extension? = Yes"). This parameter is only visible if "Function = presence button"!

Setpoint shift on pressing the button

Reduce setpoint value (level size)

Increase setpoint (level size)

This parameter defines the direction of the setpoint shift on the extension. For a setpoint value shift, the controller extension makes use of the two communication objects "Setpoint shift specification" and "Current setpoint shift". The "Current setpoint shift" communication object informs the extension about the current state of the room temperature controller. Based on this value and the respective parameter, the controller extension determines the new level size which it transmits via the "Setpoint shift specification" communication object to the room temperature controller. This parameter is only visible if "Function = Setpoint shift"!

☐ Button 2 ... Button n, see Button 1!

The following parameters are valid for the status LED of the buttons or rockers...

Function of the status LED * always OFF

Irrespective of the pushbutton or rocker function, the status LED is switched off permanently.

*: With the rocker function, the parameters for the left and right status LED are separate and configurable.

always ON

Irrespective of the pushbutton or rocker function, the status LED is switched on permanently.

Button-press display

The status LED indicates a button actuation. The ON time is set on the parameter page "General" in common for all status LEDs that are configured as actuation displays.

Telegram acknowledgment

The status LED indicates the transmission of a telegram in 2-channel

	<p>operation. This setting can only be configured for the pushbutton or rocker function "2-channel operation".</p>
Status indication (switching object)	<p>The status LED indicates the state of the communication object "Switching". If the object value is "ON", the status LED is illuminated. If the object value is "OFF" the status LED is switched off. This setting can only be configured for the pushbutton or rocker function "Switching" or "Dimming".</p>
Inverted status display (switching object)	<p>The status LED indicates the state of the communication object "Switching". If the object value is "OFF", the status LED is illuminated. If the object value is "ON" the status LED is switched off. This setting can only be configured for the pushbutton or rocker function "Switching" or "Dimming".</p>
Control via separate LED object	<p>The status LED indicates the state of its own, separate 1-bit LED object. This setting causes the additional parameter "Control of the status LED via object value" to be shown.</p>
Button function active display	<p>The status LED indicates the state of the presence button in case of controller extension operation. The LED lights up if the presence function is activated. The LED is off if the presence function is inactive. This setting can only be configured in the pushbutton function "Controller extension" and with the button function "Presence button".</p>
Button function inactive display	<p>The status LED indicates the state of the presence button in case of controller extension operation. The LED lights up if the presence function is inactive. The LED is off if the presence function is activated. This setting can only be configured in the pushbutton function "Controller extension" and with the button function "Presence button".</p>
Setpoint value shift display	<p>The status LED indicates the state of a setpoint shift in case of controller</p>

extension operation. This setting causes the additional parameter "Status LED" to be shown.

This setting can only be configured in the pushbutton function "Controller extension" and with the button function "Setpoint shift".

Operating mode display
(KNX controller)

The status LED indicates the state of a KNX room temperature controller via a separate 1-byte communication object. This setting causes the additional parameter "Status LED ON with" to be shown.

Controller status indication
(activate controller extension!)

The status LED indicates the state of the controller extension. This setting causes the additional parameter "Status LED ON with" to be shown.

Comparator without sign
(1-byte)

The status LED is activated depending on a comparison. In this configuration there is a separate 1-byte communication object available via which the unsigned reference value (0...255) is received. This setting causes the additional parameter "Status LED ON with" to be shown.

Comparator with sign
(1-byte)

The status LED is activated depending on a comparison. In this configuration there is a separate 1-byte communication object available via which the positive or negative reference value (-128...127) is received. This setting causes the additional parameter "Status LED ON with" to be shown.

The presettings of the parameter "Function of status LED" depend on the configured pushbutton or rocker function.

The function of the status LED = "Display via separate LED object"...

Control of the status LED via object value

1 = LED static ON /
0 = LED static OFF

1 = LED static OFF /
0 = LED static ON

1 = LED flashes /
0 = LED static OFF

If the "Function of status LED ..." is set to "Control via separate LED object", then the telegram polarity of the 1-bit object "Status LED" can be specified at this point.

The LED can be switched on or off statically. In addition, the received switching telegram can be evaluated in such a way that the LED flashes.

1 = LED static OFF /
0 = LED flashes

If the function of status
LED = "Operating mode
display (KNX
controller)"...

Status LED ON with

Automatic mode
Comfort mode
Standby mode
Night mode
Frost/heat protection mode

The values of a communication object
with data type 20.102 "HVAC Mode" are
defined as follows:

0 = Automatic
1 = Comfort
2 = Standby
3 = Night
4 = Frost/heat protection

The value "Automatic" is used only by
the "forced operating mode switchover"
objects.
The status LED is illuminated when the
object receives the value configured
here.

The function of the
status LED = "Controller
status indication"...

Status LED ON with

Comfort mode
Standby mode
Night mode
Frost/heat protection mode
Controller disabled
Heating / cooling
Controller inactive
(deadband operation)
Frost alarm

The "Controller status" communication
object of the controller extension
function includes eight bits of
information in one byte. This parameter
defines which bit is to be indicated by
the LED.

The controller status can be indicated
only if the controller extension is
enabled (parameter page "General")!

If the function of status
LED = "Comparator
without sign"...

Status LED ON with

**Reference value greater
than received value**

The status LED indicates whether the
configured reference value is greater or
less than or equal to the value of the
"Status LED" object".

Reference value less than
received value

Reference value equal to
received value

Reference value
(0 ... 255)

0...255

This parameter defines the reference
value to which the value of the "Status
LED" object is compared.

If the function of status LED = "Comparator with sign"...

Status LED ON with	Reference value greater than received value	The status LED indicates whether the configured reference value is greater or less than or equal to the value of the "Status LED" object".
	Reference value less than received value	
	Reference value equal to received value	
Reference value (-128 ... 127)	-128... 0 ...127	This parameter defines the reference value to which the value of the "Status LED" object is compared.

☐ Room temperature measurement

Temperature detection through	Internal temperature sensor	The "Temperature detection" parameter specifies the sensors to detect the room temperature.
	Internal and wired sensor	"Internal sensor" setting: The temperature sensor integrated in the pushbutton is activated. Thus, the actual temperature value is determined only locally on the device. "Internal and wired sensor" setting: In this setting, the temperature sources of the internal sensor and the wired remote sensor are combined.

Determination of measured value from internal / wired ratio	10% to 90% 20% to 80% 30% to 70% 40% to 60% 50% to 50% 60% to 40% 70% to 30% 80% to 20% 90% to 10%	The weighting of the measured temperature value for the internal and the wired sensor is specified here. That results in an overall value, which will be used for the further interpretation of the room temperature. This parameter is only visible with "temperature detection = internal and wired sensor".
---	---	---

Internal sensor calibration (-128...127) * 0.1 K	-128 ... 127, 0	Determines the value by which the internal sensor's room temperature value is calibrated. This parameter is only visible when the temperature detection system requires an internal sensor.
--	------------------------	--

Wired sensor adjustment (-128...127) * 0.1 K	-128 ... 127, 0	Determines the value by which the external sensor's room temperature value is calibrated. This parameter is only visible when the temperature detection system requires
--	------------------------	--

an external sensor.

Cyclical transmission of room temperature (0...255 * 1 minute) (0 = inactive) 0 ... 255, **0**

This parameter specifies whether and when the determined room temperature is to be periodically output via the "Measured temperature" object.

Transmission after room temperature change by (0..255 * +/- 0.1 K) (0 = inactive) 0 ... 255, **0**

This parameter determines the size of the value change of the room temperature after which the current values are automatically transmitted on the bus via the "Measured temperature" object.

☐↵ Disabling

Disabling function? Yes
No

With this parameter, the disabling function of the push-button sensor can be centrally activated. If "Yes", the ETS shows further communication object and parameters.

Polarity of disabling object **Disable = 1 / enable = 0**
Disable = 0 / Enable = 1

This parameter defines the value of the disabling object at which the disabling function is active.

Reaction of pushbutton sensor at the beginning of the disabling function **No reaction**
Reaction as button >>X<< when pressed
Reaction as button >>X<< when released
Reaction as disabling function 1 when pressed
Reaction as disabling function 1 when released
Reaction as disabling function 2 when pressed
Reaction as disabling function 2 when released
Internal scene recall scene 1
Internal scene recall scene 2
Internal scene recall

Besides disabling of rocker and button functions, the pushbutton sensor can also and in addition trigger a specific function at the time of activation of the disabling state.

This function can... correspond to the function assigned to any of the buttons in the non-disabled state ("Reaction as button >>X<< ..."), be defined on the following parameter pages ("Reaction as disabling function ..."), recall a scene stored internally in the pushbutton sensor ("Internal scene recall ...").

	scene 3	
	Internal scene recall scene 4	
	Internal scene recall scene 5	
	Internal scene recall scene 6	
	Internal scene recall scene 7	
	Internal scene recall scene 8	
Button >>X<<	Button 1 Button 2 ... (Selection depends on device variant!)	If the pushbutton sensor is to perform the function of a specific button at the beginning of the disabling state, this button will be selected here. Visible only if "Reaction of pushbutton sensor at the beginning of the disabling function = Reaction as button >>X<< on pressing / releasing"!
Behaviour during active disabling	all buttons without function All buttons behave as Individual buttons without function Individual buttons behave as	While disabling is active... all buttons or only individually selected buttons can be disabled ("... no function"), all buttons or only individually selected buttons can be restricted to a specific function ("... behave as"). In this case, the ETS shows further parameters.
All left buttons with even numbers behave during disabling as	Button 1 Button 2 ... (Selection depends on device variant!) Disabling function 1 Disabling function 2	If a specific button function is to be assigned during disabling to all or to individual buttons, this parameter can be used to select the desired button the function of which will then be executed. During disabling, all the left buttons behave like the one configured here. The desired functions can either correspond to the function of an existing button or they can be configured as special disabling functions. This parameter is only visible if "Behaviour during active disabling = all buttons behave as" or "Behaviour during active disabling = individual buttons behave as"!

All right buttons with even numbers behave during disabling as	Button 1 Button 2 ... (Selection depends on device variant!) Disabling function 1 Disabling function 2	If a specific button function is to be assigned during disabling to all or to individual buttons, this parameter can be used to select the desired button the function of which will then be executed. During disabling, all the right buttons behave like the one configured here. The desired functions can either correspond to the function of an existing button or they can be configured as special disabling functions. This parameter is only visible if "Behaviour during active disabling = all buttons behave as" or "Behaviour during active disabling = individual buttons behave as"!
Reaction of pushbutton sensor at the end of disabling	No reaction Reaction as button >>Y<< when pressed Reaction as button >>Y<< when released Reaction as disabling function 1 when pressed Reaction as disabling function 1 when released Reaction as disabling function 2 when pressed Reaction as disabling function 2 when released Internal scene recall scene 1 Internal scene recall scene 2 Internal scene recall scene 3 Internal scene recall scene 4 Internal scene recall scene 5 Internal scene recall scene 6 Internal scene recall scene 7 Internal scene recall scene 8	Besides disabling of rocker and button functions, the pushbutton sensor can also trigger a special function immediately at the end of disabling. This function can... correspond to the function assigned to any of the buttons in the non-disabled state ("Reaction as button >>X<< ..."), be defined on the following parameter pages ("Reaction as disabling function ..."), recall a scene stored internally in the pushbutton sensor ("Internal scene recall ...").

Button >>Y<<	Button 1 Button 2 ... (Selection depends on device variant!)	If the pushbutton sensor is to perform the function of a specific button at the end of the disabling state, this button will be selected here. Only visible if "Reaction of pushbutton sensor at the end of disabling = Reaction as button >>Y<< on pressing / releasing"!
--------------	--	---

Disable - Button selection (Visible only if "Behaviour during active disabling = individual buttons without function" or "Behaviour during active disabling = individual buttons behave as"!)

Selection of the buttons for behaviour during disabling

Button 1?	Yes No	The user can specify for each button separately whether it will be affected by the disabling function during the disabling state.
Button 2?	Yes No	

...

(Selection depends on device variant!)

Disabling function 1 disable / Disabling function 2 disable. With the exception of the status LED control, the parameters available for the two disabling functions are the same as those for the button functions.

Scenes / scene data types (name of parameter page changes with scene function activated).

Scene function ?	Yes No	The pushbutton sensor can handle internally eight scenes with eight actuator groups. This parameter activates the scene function and the other parameters and communication objects, if needed.
------------------	------------------	---

Overwrite scene values during ETS download	Yes No	If the values of the actuator groups that have been changed on site by the customer are to be reset to the values preset in the ETS during an application download by the ETS, the setting "Yes" must be chosen. If "No" is selected, the ETS values will not overwrite the scene values stored in the push button sensor, if any.
--	------------------	--

Data types Scene output 1	Switching Value (0 ... 255)	The pushbutton sensor has an independent communication object for each of the eight actuator groups. With
------------------------------	---------------------------------------	---

	Value / position of Venetian blind (0 ... 100 %)	these parameters, the object type can be set separately for each output.
... Scene output 8	Switching Value (0 ... 255) Value / position of Venetian blind (0 ... 100 %)	
<input type="checkbox"/> Scene 1		
Recall via extension object with scene number	1...64	If the internal scenes are to be recalled via the extension object, a definite number is required for each of them. This parameter serves to specify the extension number of the first scene. If several internal scenes have the same scene number, only the first scene with this number can be called up.
Scene output 1 Switching command	ON OFF	This parameter can be used to predefine the switching command of the first scene output. This parameter is only visible if "Data types scene output 1 = switching"!
Scene output 1 Value (0 ... 255)	0...255	This parameter can be used to predefine the value of the first scene output. This parameter is only visible if "Data types scene output 1 = switching"!
Scene output 1 Value / position of Venetian blind (0 ... 100 %)	0...100	This parameter can be used to predefine the value of the first scene output. This parameter is only visible if "Data types scene output 1 = switching"!
Scene output 1 Allow save?	Yes No	If the user is to be given the possibility of changing the value of the actuator group (scene output) within this scene and of storing it during regular operation, this parameter must be set to "Yes".
Scene output 1 Allow transmission?	Yes No	If the state of an actuator group is to remain unchanged during the recall of a scene, this parameter can be set to "No". In this case, the push button sensor does not transmit a telegram via the scene output concerned during the recall of the scene. The scene output is deactivated for this scene.

Scene output 1 Transmit delay (1 ... 1200 * 100 ms) (0 = deactivated)	0...1200	<p>When the push button sensor sends the telegrams to the various scene outputs, it can insert a presettable waiting time of 2 min. max. before each telegram.</p> <p>This can be used to reduce bus loading, but also to have certain lamps switched on only after the shutters are really closed.</p> <p>If no delay is selected, the pushbutton sensor sends the output telegrams with maximum speed. With this setting it may happen in some cases that the telegram sequence is not compatible with output numbering.</p>
Scene outputs 2 ... 8 see scene output 1!		
<input type="checkbox"/> Scenes 2 ... 8 see scene 1!		
<input type="checkbox"/> Alarm signalling		
Alarm signal display	Activated Deactivated	<p>This parameter can be used to enable alarm signal displaying. When alarm signalling is enabled, the ETS displays further parameters and up to two further communication objects.</p>
Polarity of the alarm signalling object	Alarm when ON and alarm reset when OFF Alarm when OFF and alarm reset when ON	<p>The alarm signalling object is used as an input for activating or deactivating alarm signal displaying. If the object value corresponds to the "Alarm" state, all status LEDs and the operation LEDs flash with a frequency of approx. 2 Hz.</p> <p>If the setting is "Alarm when OFF and alarm reset when ON", the object must first be actively written by the bus with "0" to activate the alarm after a reset.</p> <p>An alarm signal is not stored so that the alarm signalling is generally deactivated after a reset or after programming with the ETS.</p>
Reset alarm signalling by a button-press?	Yes No	<p>If this parameter is set to "Yes", active alarm signal displaying can be deactivated by a button-press on the push button sensor. This button-press does not cause the configured function of the pressed</p>

		<p>button to be executed. Only after then next button-press will the configuration of the button be evaluated and a telegram be transmitted to the bus, if applicable.</p> <p>If "No" has been selected, alarm signalling can only be deactivated via the alarm signalling object. A button-press will always execute the configured button function.</p>
Use the alarm acknowledge object?	<p>Yes</p> <p>No</p>	<p>If alarm signalling can be deactivated by a button-press, this parameter defines whether an additional alarm acknowledge telegram is to be transmitted to the bus via the separate object "Alarm signalling acknowledge" after triggering by this button-press.</p> <p>A telegram can, for instance, be sent via this object to the "Alarm signalling" objects of other push button sensors in order to reset the alarm status there as well (observe the polarity of the acknowledge object!).</p>
Acknowledge alarm signalling by	<p>OFF telegram</p> <p>ON telegram</p>	<p>This parameter sets the polarity of the "Alarm signalling acknowledge" object. This parameter presetting depends on the selected polarity of the alarm message object.</p>

5 Appendix

5.1 Index

C	
controller extension.....	59
D	
Dimming.....	39
Dismantling.....	10
E	
ETS	18
ETS search paths.....	14
F	
Full-surface operation.....	33
O	
Object for light scene function.....	30-31
Operating areas.....	12, 32
Operation LED.....	37
P	
push-button function.....	34
R	
rocker function.....	32
room temperature.....	65
S	
Scene control.....	53
Scene extension.....	47
Scene function.....	53
Scope of functions.....	16
Status LED.....	50
Switching.....	38
T	
Temperature calibration.....	64
Temperature detection.....	64
Transmission delay.....	37
V	
value transmitter.....	45
Venetian blind.....	41

Berker GmbH & Co. KG
Klagebach 38
58579 Schalksmühle/Germany
Telefon + 49 (0) 2355/905-0
Telefax + 49 (0) 2355/905-111
www.berker.de