

CO2-sensor

Issue: 15.07.2015
13537810

Table of Contents

1	Product definition	4
1.1	Product catalogue	4
1.2	Function	4
2	Installation, electrical connection and operation	6
2.1	Safety instructions	6
2.2	Device components	7
2.3	Fitting and electrical connection	8
2.4	Commissioning	11
3	Technical data	12
4	Software description	13
4.1	Software specification	13
4.2	Software "KNX CO2 sensor"	14
4.2.1	Scope of functions	14
4.2.2	Notes on software	17
4.2.3	Object table	18
4.2.3.1	Object table push button interface	18
4.2.3.2	Object table room temperature controller	21
4.2.3.3	Object table sensors	35
4.2.3.4	Object table logic gates	39
4.2.4	Functional description	40
4.2.4.1	Application basics	40
4.2.4.2	Push button interface	42
4.2.4.2.1	Introduction	42
4.2.4.2.2	Function "no function"	43
4.2.4.2.3	Switching function	44
4.2.4.2.4	Dimming function	45
4.2.4.2.5	Venetian blind function	46
4.2.4.2.6	Function "Value transmitter 1 byte / 2 byte"	48
4.2.4.2.7	Function "Light scene extension with/without memory function"	50
4.2.4.2.8	Response to bus voltage return	51
4.2.4.2.9	Disabling function of the Inputs	52
4.2.4.3	Sensor function	53
4.2.4.3.1	Temperature sensor	53
4.2.4.3.2	Humidity sensor	54
4.2.4.3.3	CO2 sensor	55
4.2.4.3.4	Limiting values	57
4.2.4.4	Room temperature controller	63
4.2.4.4.1	Operating modes and operating mode change-over	63
4.2.4.4.2	Control algorithms and calculation of command values	66
4.2.4.4.3	Adapting the control algorithms	73
4.2.4.4.4	Operating mode switchover	76
4.2.4.4.5	Temperature setpoints	85
4.2.4.4.6	Room temperature measurement	97
4.2.4.4.7	Command value and status output	100
4.2.4.4.8	Disable functions of the room temperature controller	107

4.2.4.4.9 Valve protection	108
4.2.4.5 Logic gate	109
4.2.4.6 Delivery state	111
4.2.5 Parameters	112
4.2.5.1 Parameter sensor	112
4.2.5.2 Room temperature controller parameter	123
4.2.5.3 Push button interface parameter	140
4.2.5.4 Logic gate parameter	164
5 Appendix	168
5.1 Index	168

1 Product definition

1.1 Product catalogue

Product name: CO₂-sensor
Use: Sensor
Design: UP (concealed)
Order No. 754413xx

1.2 Function

The device combines the functions of a KNX bus coupling unit, single-room temperature controller with setpoint presetting, temperature and humidity sensor and CO₂ sensor in one bus device. The room temperature controller, humidity and CO₂-Sensor functions are each independent function sections of the device with their own parameter blocks in the ETS. The functions can be configured in the ETS.

In addition, the device has two binary inputs that can be disabled during operation, and by means of which actuators can be controlled via KNX telegrams, e.g., for controlling fans or window drives. Through the combination of all functions it is possible to monitor the indoor air quality and to control measures for preserving the air quality via the bus.

CO₂ sensor functionality

The device can be used for determining the CO₂ content of the ambient air. Depending on configured limiting values and current CO₂ actual value, telegrams can be transmitted to the KNX for controlling fans or window drives. Four freely definable limiting values, which can be used by switching command telegrams for controlling actuators or displays, can be programmed for this purpose. The CO₂ content determined can be transmitted to the bus as a 2-byte measured value via a separate object and be made available to KNX display components or to supplementary filter units, for example.

Since the measurement of correct values strongly depends on air pressure, a calibration according to the height of the mounting location above NN (sea level) can be performed with the aid of the ETS parameters.

Room temperature controller functionality

The device can be used for single-room temperature control. Depending on the operating mode, the current temperature set value and on the room temperature, a variable for heating or cooling control can be sent to the KNX. The controller distinguishes between different operating modes (comfort, standby, night) each with their own temperature setpoints for heating or cooling.

In addition to the heating or cooling basic level, activating an additional heater and/or cooling unit means that an additional heating or cooling unit can be used. In this connection, you can set the temperature setpoint difference between the basic and the additional level by a parameter in the ETS. For major deviations between the temperature setpoint and the actual temperature, you can activate this additional level to heat up or cool down the room faster. You can assign different control algorithms to the basic and additional levels. For heating and cooling functions, you can select continuous or switching PI or switching 2-point feedback control algorithms.

The room temperature can be recorded either by the internal or by an external temperature sensor. A KNX communication object is available for the external temperature sensor by means of which the temperature value received from the external bus, e.g. from a controller extension, can be integrated into the temperature detection.

Humidity sensor functionality

The device can be used for determining the humidity of the ambient air. Depending on configured limiting values and the current air humidity, value switching telegrams can be transmitted to the KNX for controlling fans or window drives. The air humidity determined can be transmitted to the bus as a 2-byte measured value via a separate object, and in this way, be

made available to KNX display components.

The value of the air humidity measured by the humidity sensor together with the measured room temperature is used for calculating the dew point.

Dew point alarm

The dew point of water in the formal sense is the condensation point of pure water and thus a value pair from air humidity and room temperature. The temperature value of the dew point, i.e. the dew point temperature, is normally equated with the dew point. This concerns the temperature of the air with a specific humidity at which the condensation on an object is currently forming.

The dew point temperature is calculated by the device on the basis of the determined room temperature and is adjusted by means of the Magnus formula. This is an approximation formula for calculating the saturated vapour pressure depending on the temperature, which is used in meteorology and building physics.

The dew point temperature determined can be transmitted to the bus as a 2-byte value via a separate object and be made available to KNX display components, for example. Once the dew point temperature has been reached, the device can transmit a dew point alarm to the bus in the form of switching or value telegrams. This dew point alarm can take place up to a maximum lead of 5 K in order to realise a pre-warning function.

Functionality of binary inputs

The device has a push-button interface with 2 independent channels and transmits telegrams to the KNX after activation of a connected switch or push-button contact of a rocker switch or button depending on the ETS parameter setting. These can be, for instance, telegrams for switching or push button control, for dimming or for controlling blinds. It is also possible to program value transmitter functions such as dimming value transmitters or light scene extensions. These inputs are lockable during operation. The insert for the presence detector is also possible.

Logic gates

In order to implement logical dependencies from external states as well or to cascade, the device software has four logic gates. Each gate can have from one to a maximum of four inputs. The type of logic operation can be set as "AND", "OR", "EXCLUSIVE OR" or as "AND with feedback" for each logic gate. In addition, each input can be operated normally or inverted. The communication objects of the outputs can be configured as 1-bit or 1-byte objects. Outputs that transfer switching commands can also work inverted.

The inputs can either be used separately with their own communication objects or can also, if necessary, be linked optionally to limiting values of the CO₂- and humidity measurement, to the objects of the dew point alarm or to output objects of other logic functions. The outputs can work with a time delay if necessary. The transmission criterion for input event, output change and cyclical transmission is adjustable. Several logic gates can be combined with each other for complex logic operation functions.

General

The device is flush mounted in a switchbox and covers the surface of a socket. The device is a so-called monoblock product. It does not require any separate bus coupling or additional power supply.

The programming mode of the device is indicated by a separate programming LED. It is located on the front of the design covers directly next to the programming button and continues flashing until an application is loaded. In this manner the device can be commissioned easily with the ETS even in the installed state. Project planning and commissioning of the device is performed using the ETS 3.0f or newer versions.

2 Installation, electrical connection and operation

2.1 Safety instructions

Electrical equipment may only be installed and fitted by electrically skilled persons.

Failure to observe the instructions may cause damage to the device and result in fire and other hazards.

Do not use for safety-related gas measurements.

During renovation work, protect the device against soiling through paint, wallpaper paste, dust, etc. Device can be damaged.

Do not clean or store the device with organic solvents or expose it to their vapours. Do not stick any adhesive labels. Do not store device in packaging or environments that contain softening agents, e.g. bubble wrap or polystyrene. Before starting renovation work, remove the device from the system and store it in a suitable place. The function of the temperature and humidity sensor may be permanently impaired.

Danger of electric shock on the KNX installation. Do not connect any external voltage to the inputs. Doing so may damage the device(s), and the SELV potential on the KNX bus line will no longer be available.

2.2 Device components

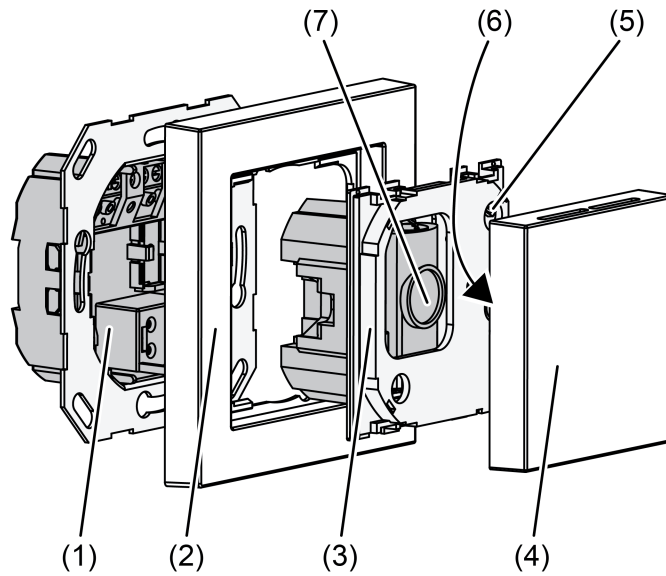

Figure 1: Device components CO₂ Sensor

- (1) Terminal insert
- (2) Design frame
- (3) Electronics cover
- (4) Cover
- (5) Programming button and LEDs
- (6) Locking screw (plastic)
- (7) Sensor window CO₂ sensor

2.3 Fitting and electrical connection

**DANGER!**

When mounting with 230 V devices under a common cover, e.g. socket outlets, there is a danger of electrical shocks in the event of a fault!

Electrical shocks can be fatal.

Only use the preassembled plastic screw as locking screw!

**CAUTION!**

Electrostatic discharges

Device damage

Only operate the device with cover.

Mounting and connecting the device

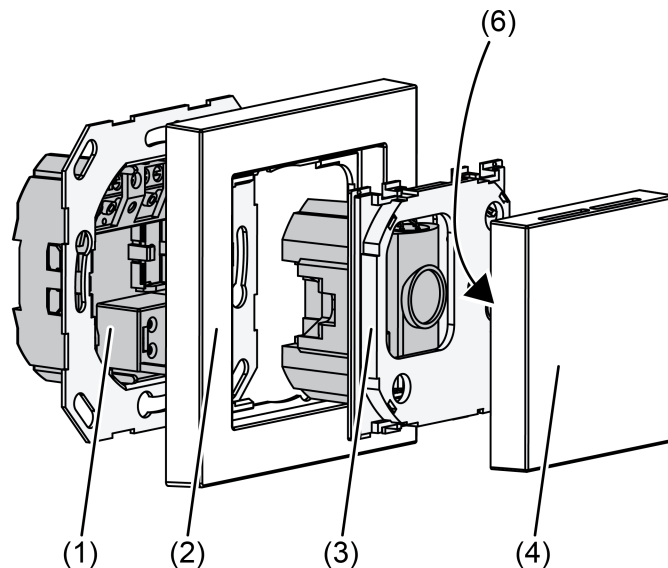

Figure 2: Device fitting

- (1) Terminal insert
- (2) Design frame
- (3) Electronics cover
- (4) Cover
- (6) Locking screw (plastic)

Observe the routing conditions for SELV.

Do not route input cables parallel to mains cables. Otherwise there might be signal interference.

Recommendation: Use deep accessory sockets!

The optimum installation height is approx. 1.5 m.

- Removing the cover (4) .
- Isolate terminal insert (1) from electronic insert (3).

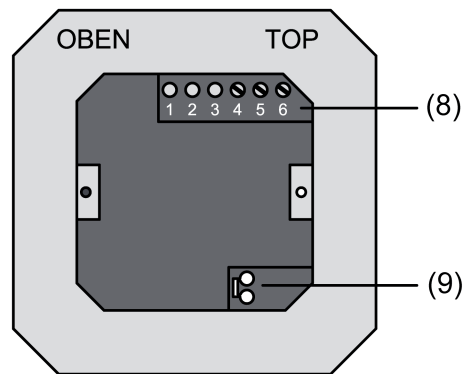

Figure 3: Terminal insert with connections

- (8) Connecting strip binary inputs
- (9) KNX connection

- Insert the stripped bus cables into the terminal (9) in the terminal insert (Figure 3)

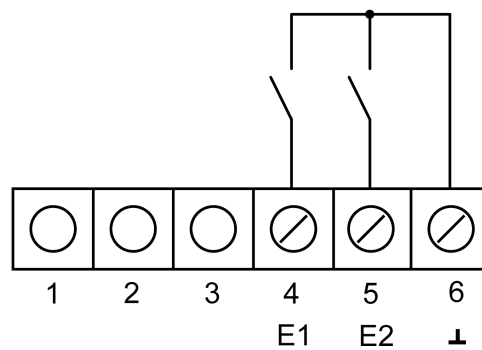

Figure 4: Connection of binary inputs

1..3 Not assigned

- 4 Connection binary input E1
- 5 Connection binary input E2
- 6 Reference potential E1, E2

- Window contacts, NO contact or NC contact push-buttons can be connected to terminals 4, 5 and 6 of the connecting strip binary inputs (8).
- Insert terminal insert (1) in appliance box. Note label OBEN / TOP. The bus connection must be to the right and below.
- Fit the Design frame (2) on terminal insert (1).
- Insert the electronics cover (3) into the terminal insert in the correct orientation.
- Fasten the electronics cover with the locking screw (6).
- Reattach the cover (4).

- i** Do not use the device in multiple combinations with other UP devices as their heat generation can influence the temperature and humidity measurement of the controller.
- i** Do not mount the device near sources of interference such as electric cookers, refrigerators, draughts or direct sunlight. This also influences the temperature and humidity reading of the controller.

Dismantling the device

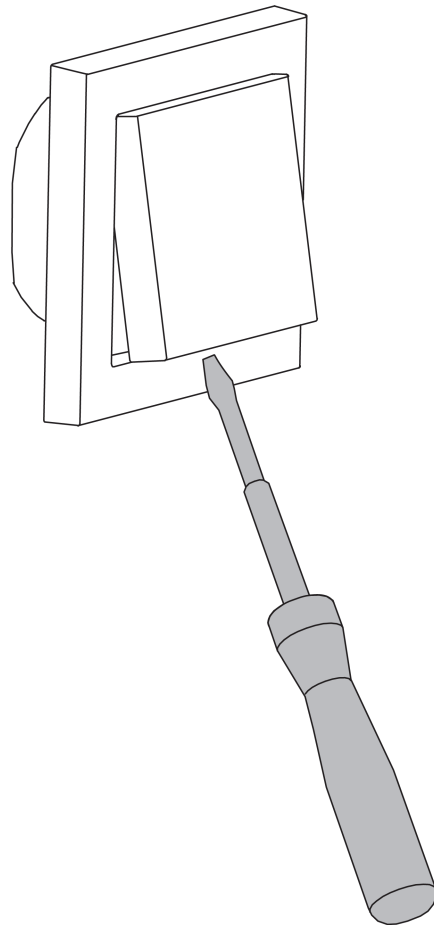

Figure 5: Device dismantling

Design cover and electronics cover should be dismantled during painting and decorating work.

- Insert screwdriver in slot on the bottom of the cover and raise it carefully.
- i** Do not damage cover and design frame.
- Loosen locking screw in the electronics cover.
- Remove electronics cover from terminal insert.
- i** During the subsequent fitting, the cover must be mounted again onto the respective insert. Therefore, please pay attention to the correct labelling of the cover and insert during the dismantling and label these accordingly.

2.4 Commissioning

Loading the physical address and application software

The commissioning of the device is basically confined to programming of the physical address and the application data with the ETS.

Project planning and commissioning of the device using the ETS 3.0f or newer versions.

The device is connected and ready for operation.

An appropriate device must be created and configured in the ETS project.

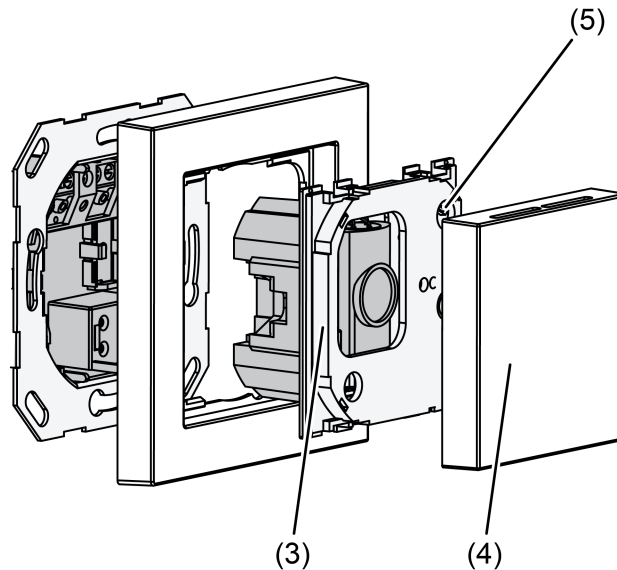

Figure 6: Location of the programming button and LED

The programming button is located behind the blank cover (4) on the electronics cover (3) .

- Remove the blank cover (4) if it is already mounted.
 - Activating Programming mode: push the programming button (5).
The programming LED (5) lights up red.
 - Program the physical address with the help of the ETS.
The programming LED goes out.
 - Record the physical address on the terminal insert and on the back of the electronics cover.
- i** Observe the correct assignment of inserts and covers when assembling after painting or wallpapering work.
- Mount blank cover.
 - Load the application data into the device using the ETS.
- i** If the device was programmed with wrong application data, the device is without function after the commissioning.

3 Technical data

General

Protection class	III
Mark of approval	KNX/EIB
Ambient temperature	-5 ... +45 °C
Storage/transport temperature	+10 ... +50 °C
Storage/transport humidity	20 ... 60 % rel. humidity

KNX

KNX medium	TP
Commissioning mode	S-mode
Rated voltage KNX	DC 21 ... 32 V SELV
Current consumption KNX	typical 12.5 mA
Current consumption KNX	max. 25 mA (4 s/15 s as a cycle)
Connection mode KNX	Connection terminal

Binary inputs

Cable length	max. 5 m
Cable type	J-Y(St)Y 2 x 2 x 0.8 mm

CO2 sensor

Measuring range	0 ... 2000 ppm
-----------------	----------------

Humidity sensors

Measuring range	10 ... 95 % rel. humidity
-----------------	---------------------------

Temperature sensors

Measuring range	-5 ... +45 °C
-----------------	---------------

4 Software description

4.1 Software specification

ETS search paths: - heating, air condition, ventilation / regulator / CO2-sensor
Configuration: S-mode standard
PEI type: "00"_{Hex} / "0"_{Dec}
PEI connector: none
BAU used: FZE 1066 + μ C

Application for CO₂ sensor:

No.	Short description	Name	Version	from mask version
1	CO2-/air humidity sensor with room temperature controller, 2 binary inputs, dew point alarm and logic gates.	CO2 sensor 706211	1.1 for ETS3.0 Version "f" onwards or ETS4	705

4.2 Software "KNX CO2 sensor"

4.2.1 Scope of functions

Pushbutton interface functionality

General

- Free allocation of the functions switching, dimming, Venetian blind and value transmitter to max. 2 inputs.
- Disable object for disabling individual inputs (polarity of the disable object is adjustable).
- Delay on bus voltage return and debouncing time centrally adjustable.
- The behaviour on bus voltage return can be configured separately for each input.
- Telegram rate limit generally adjustable for all inputs.

"Switching" function

- Two independent switching objects are available for each input, switching commands can be configured individually.
- Command can be set independently for rising and falling edge. Executable switching commands may include "ON", "OFF", "TOGGLE" or "no reaction".

Dimming function

- The choice between single-surface and double-surface operation is possible. Executable switching commands may include "Brighter (ON)", "darker (OFF)" or "TOGGLE".
- Time between dimming and switching and also the dimming increments is adjustable.
- Cyclical transmission of telegram repetitions as well as transmission of a stop telegram at the end of a dimming procedure is possible.

"Blind" function

- Command can be set independently for rising edge. Executable switching commands may include "no function", "UP", "DOWN" or "TOGGLE".
- The operation concept is configurable (short – long – short or long – short).
- In the operation concept Short – Long – Short, the time between short and long-time operation is adjustable.
- The slat adjusting time is adjustable. This is the time during which a MOVE command can be terminated by releasing a push-button at the input.

Function value transmitter (dimming, temperature, brightness)

- The edge (push-button as NO contact, push-button as NC contact, switch) and the value to be transmitted are configurable on edge.
- When programming as a push-button, the value for the value transmitter can be adjusted by a long button-press.

Function light scene extension

- Configuration as light scene extension with or without memory function. In the light scene extension with memory function, a light scene can be stored by a long press of the connected push-button.
- The edge (push-button as NO contact, push-button as NC contact, switch) and the value to be transmitted are configurable on edge.

Room temperature controller functionality

General

- 4 various operating modes can be activated: Comfort, Standby, Night and Frost/heat protection
- The operating mode switchover is performed via 1-byte object according to the KNX specification or using up to four individual 1-bit objects.

Heating / cooling

- The operating modes "Heating", "Cooling" or "Heating and Cooling" are available with or without additional level.

- The control algorithms of the temperature control are configurable, either the switching 2-point feedback control, the switching PI control (PWM) or the continuous PI control.
- The command value output 1-bit (switching) or 1-byte (continuous).
- The adjustable control parameters for the PI control are "Proportional range" and "Reset time", for the 2-point feedback control "Hysteresis".

Setpoint values

- Each operating mode can be assigned its own temperature-setpoints (for heating and/or cooling).
- The setpoints for the additional level are derived by a configurable level offset from the values of the basic setpoint.
- The basic setpoint shift is possible by means of communication objects.

Functions

- Switching between "Heating" and "Cooling" can be automatic or object-oriented.
- Deactivating the feedback control possible using separate 1-bit objects.
- The comfort extension is possible by pressing a configurable presence button or presence detector in the night or frost/heat protection mode.
- The length of the comfort extension can be parameterized.
- The status information is configurable and can be transmitted to the bus via an object (1-byte / 1-bit).
- Deactivating the feedback control or the additional level is possible using separate 1-bit objects.

Room temperature measurement

- The room temperature can be measured by means of an internal or external room temperature sensor. The external temperature sensor must be a KNX temperature sensor coupled via the bus. Alternatively, both temperature sensors can be combined together. The determination of the measured value from the internal to external sensor is configurable.
- The polling time of the external temperature sensor is settable.
- The change interval for the automatic transmission of the actual temperature can be defined in the ETS. Cyclical transmission of the room temperature is possible, too.
- The room temperature measurement (actual value) can be adjusted separately for the internal and external sensor using parameters.
- The frost protection mode switch-over is possible by the window status or by the automatic frost protection.

Actuating variable output

- The separate or shared command value output in heating and cooling mode is possible. This produces one or two command value objects for each level.
- Normal or inverted command value output is configurable
- Automatic transmission and cycle time for command value output is configurable.

Humidity sensor functionality**Humidity measurement**

- The humidity is measured by the integrated measuring element.
- Two limiting values can be assigned to the humidity measured value, and if exceeded or fallen short of, ventilation controllers can be activated, for example.

Dew point determination

- The dew point temperature is calculated by the device on the basis of the determined room temperature.
- The determined humidity value of the sensor is adjusted by means of the Magnus formula which is an approximation formula for calculating the saturated vapour pressure depending on the temperature. It is very accurate (< 0.22 %) in the range between 0°C and 100°C and is primarily used in meteorology and building physics for determining the dew point.

CO₂ controller functionality

- i** After switch-on, the CO₂ sensor requires a warm-up period of up to 5 minutes, until normal operation is reached.
The automatic calibration method is only available in the case of permanent power supply and after 24 hours for the first time.

CO₂ measurement

- The CO₂ is measured by means of the integrated sensor module.
- The "height of the location above sea level" is configurable because the exact measured value of the CO₂ sensor is air pressure dependent.

Limiting values

- Four limiting values can be assigned to the CO₂ measured value, and if exceeded or fallen short of, ventilation controllers can be activated, for example.
- The hysteresis and behaviour can be specified for all limiting values should the limiting value be exceeded or undershot.
- A switch-on and switch-off delay can be configured for all limiting values (also applies to cyclical transmission).
- The transmission criterion cyclical transmission is configurable for all limiting values.

Logic gates functionality

- Up to four logic gates with one up to a maximum of four inputs can be configured. Each of the inputs can be operated normal or inverted.
- Possible logic operations are "AND", "OR", "Exclusive OR" or "AND with return".
- The communication objects of the outputs can be configured as 1-bit or 1-byte objects.
- The transmission criterion for input event, output change and cyclical transmission can be set.
- The transmission delay can be configured individually for all logic gates.

4.2.2 Notes on software

ETS project design and commissioning

For configuration and commissioning of the device, ETS3.0 from Version "f" onwards or ETS4 is required. Through use of these ETS version, advantages are gained with regard to the programming process (differential download).

The necessary product database is offered in the *.VD4 format.

A plug-in integrated in the ETS product database permits the configuration.

4.2.3 Object table

Number of communication objects:	139 (max. object number 138 - gaps in between)
Number of addresses (max):	254
Number of assignments (max):	255
Dynamic table management	No

4.2.3.1 Object table push button interface

Objects of the push button interface

Function:	Switching				
Object	Function	Name	Type	DPT	Flag
 ^{0,1}	Switching object 1.1	B.Channel 1 / 2	1-bit	1.001	C, W, T, (R) ¹
Description	1-bit object for transmission of switching telegrams (ON, OFF, TOGGLE).				

Function:	Switching				
Object	Function	Name	Type	DPT	Flag
 ^{2,3}	Switching object 1.2	B.Channel 1 / 2	1-bit	1.001	C, W, T, (R) ¹
Description	1-bit object for transmission of switching telegrams (ON, OFF, TOGGLE).				

Function:	Dimming				
Object	Function	Name	Type	DPT	Flag
 ^{0,1}	Switching	B.Channel 1 / 2	1-bit	1.001	C, W, T, (R) ¹
Description	1-bit object for transmission of switching telegrams (ON, OFF, TOGGLE).				

Function:	Dimming				
Object	Function	Name	Type	DPT	Flag
 ^{2,3}	Dimming	B.Channel 1 / 2	4-bit	3.007	C, W, T, (R) ¹
Description	4-bit object for the transmission of relative dimming telegrams.				

Function:	Venetian blind				
Object	Function	Name	Type	DPT	Flag
 ^{0,1}	Short time operation	B.Channel 1 / 2	1-bit	1.007	C, T (R) ¹
Description	1-bit object for the transmission of telegrams with which a Venetian blind or shutter drive motor can be stopped or with which the blind slats can be adjusted by short time operation.				

1: Each communication object can be read out. For reading, the R-flag must be set.

Function: Venetian blind

Object	Function	Name	Type	DPT	Flag
 ^{2, 3}	Long-time operation	B.Channel 1 / 2	1-bit	1.008	C, W, T, (R) ¹

Description 1-bit object for the transmission of telegrams with which a Venetian blind or shutter drive motor can be moved upwards or downwards.

Function: Value transmitter

Object	Function	Name	Type	DPT	Flag
 ^{0, 1}	Dimming value	B.Channel 1 / 2	1 byte	5.001	C, T (R) ¹

Description 1-byte object for the transmission of values from 0 to 255 (corresponding to values from 0 % to 100 %). If the adjustment of the value is enabled, the object can transmit telegrams cyclically after long actuation with which the value can be reduced or increased by a presettable amount.

Function: Value transmitter

Object	Function	Name	Type	DPT	Flag
 ^{0, 1}	Scene extension	B.Channel 1 / 2	1 byte	18.001	C, T (R) ¹

Description 1-byte object for recalling or storing one of a maximum of 64 scenes of a scene push-button or actuator with scene function.

Function: Value transmitter

Object	Function	Name	Type	DPT	Flag
 ^{0, 1}	Temperature value	B.Channel 1 / 2	2 byte	9.001	C, T (R) ¹

Description 2 -byte object for the transmission of a temperature value from 0 °C to 40 °C. If the adjustment of the value is enabled, the object can transmit telegrams cyclically after a long press with which the value can be reduced or increased by 1 K.

Function: Value transmitter

Object	Function	Name	Type	DPT	Flag
 ^{0, 1}	Brightness value	B.Channel 1 / 2	2 byte	9.004	C, T (R) ¹

Description 2-byte object for the transmission of a brightness level value from 0 to 1500 lux. If the adjustment of the value is enabled, the object can transmit cyclical telegrams after a long press with which the value can be reduced or increased by 50 lux.

1: Each communication object can be read out. For reading, the R-flag must be set.

Function: Disable – switching

Object	Function	Name	Type	DPT	Flag
 ^{4, 5}	Disabling switching object 1.1	B.Disable channel 1 / 2	1-bit	1.001	C, W, (R) ¹

Description 1-bit object by which the switching object can be disabled and enabled again (polarity and behaviour at the beginning and end of the disabling function are configurable).

Function: Disable – switching

Object	Function	Name	Type	DPT	Flag
 ^{6, 7}	Disabling switching object 1.2	B.Disable channel 1 / 2	1-bit	1.001	C, W, (R) ¹

Description 1-bit object by which the switching object can be disabled and enabled again (polarity and behaviour at the beginning and end of the disabling function are configurable).

Function: Disabling – Dimming/Venetian blind/Value transmitter

Object	Function	Name	Type	DPT	Flag
 ^{4, 5}	Disabling	B.Disable channel 1 / 2	1-bit	1.001	C, W, (R) ¹

Description 1-bit object by which the function can be disabled and enabled again (polarity and behaviour at the beginning and end of the disabling function are configurable).

1: Each communication object can be read out. For reading, the R-flag must be set.

4.2.3.2 Object table room temperature controller

Objects for room temperature measurement

Function:	Room temperature measurement				
Object	Function	Name	Type	DPT	Flag
 23	Actual temperature	R.Output	2 byte	9.001	C, -, T, R
Description	2-byte object to output the actual temperature (room temperature) determined by the controller and used for the room temperature control. Possible value range: -99.9 °C to +99.9 °C / Measurement range of internal temperature sensor: 0 °C to +40 °C. The temperature value is always output in the format "°C".				

Function:	Room temperature measurement				
Object	Function	Name	Type	DPT	Flag
 24	Received temperature	R.Input	2 byte	9.001	C, W, -, (R) ¹
Description	2-byte object for coupling an external KNX room temperature sensor. Thus cascading of multiple temperature sensors for room temperature measurement. Possible range of values: -99.9 °C to +99.9 °C. The temperature value must always be specified in the format "°C".				

Objects for setpoint temperature specification

Function:	Setpoint temperature specification				
Object	Function	Name	Type	DPT	Flag
 26	Basic setpoint	R.Input	2 byte	9.001	C, W, -, (R) ¹
Description	2-byte object for external setting of the basic setpoint for absolute setpoint presetting. Depending on the operating mode, the possible range of values is limited by the configured frost protection and/or heat protection temperature. The controller rounds the temperature values received via the object depending on the configured interval of the basic setpoint shift (0.1 K or 0.5 K). The temperature value must always be specified in the format "°C".				

Function:	Setpoint temperature specification				
Object	Function	Name	Type	DPT	Flag
 26	Setpoint active operating mode	R.Input	2 byte	9.001	C, W, (T), (R) ¹
Description	2-byte object for external setting of a setpoint for <u>absolute setpoint presetting</u> . Depending on the operating mode, the possible range of values is limited by the configured frost protection and/or heat protection temperature. The controller rounds the temperature values received via the object to 0.1 K. The temperature value must always be specified in the format "°C". The setpoint modified by the setpoint shift can be reported back to the bus via the object by setting the "Transmit" flag.				

1: Each communication object can be read out. For reading, the R-flag must be set.

Objects for operating mode change-over

Function: Operating mode switchover

Object	Function	Name	Type	DPT	Flag
 ²⁸	Operating mode switchover	R.Input	1 byte	20.102	C, W, T, (R) ¹

Description 1-byte object for change-over of the operating mode of the controller according to the KNX specification. This object is only available in this way when the operating mode change-over is to take place over 1 byte (parameter-dependent).

Function: Operating mode switchover

Object	Function	Name	Type	DPT	Flag
 ³²	Operating mode forced-control	R.Input	1 byte	20.102	C, W, T, (R) ¹

Description 1-byte object for forced change-over (highest priority) of the operating mode of the controller according to the KNX specification. This object is only available in this way when the operating mode change-over is to take place over 1 byte (parameter-dependent).

Function: Operating mode switchover

Object	Function	Name	Type	DPT	Flag
 ²⁸	Comfort mode	R.Input	1-bit	1.001	C, W, T, (R) ¹

Description 1-bit object for change-over to the "Comfort" operating mode. This object is only available in this way when the operating mode change-over is to take place over 4 x 1 bit (parameter-dependent).

Function: Operating mode switchover

Object	Function	Name	Type	DPT	Flag
 ²⁹	Standby mode	R.Input	1-bit	1.001	C, W, T, (R) ¹

Description 1-bit object for change-over to the "Standby" operating mode. This object is only available in this way when the operating mode change-over is to take place over 4 x 1 bit (parameter-dependent).

Function: Operating mode switchover

Object	Function	Name	Type	DPT	Flag
 ³⁰	Night operation	R.Input	1-bit	1.001	C, W, T, (R) ¹

Description 1-bit object for change-over to the "Night" operating mode. This object is only available in this way when the operating mode change-over is to take place over 4 x 1 bit (parameter-dependent).

1: Each communication object can be read out. For reading, the R-flag must be set.

Function: Operating mode switchover

Object	Function	Name	Type	DPT	Flag
 ³¹	Frost/heat protection	R.Input	1-bit	1.001	C, W, T, (R) ¹

Description 1-bit object for change-over to the "Frost / heat protection" operating mode. This object is only available in this way when the operating mode change-over is to take place over 4 x 1 bit (parameter-dependent).

Function: Operating mode switchover presence object

Object	Function	Name	Type	DPT	Flag
 ³³	Presence object	R.Input / Output	1-bit	1.018	C, W, T, (R) ¹

Description 1-bit object through which a motion detector or an external presence button can be linked to the controller. The object also transmits the state of a presence button of the device to the bus.
Polarity: presence detected = "1", presence not detected = "0".

Function: Operating mode switchover presence object

Object	Function	Name	Type	DPT	Flag
 ³³	Presence object	R.Input	1-bit	1.018	C, W, -, (R) ¹

Description 1-bit object through which a motion detector can be linked to the controller.
Polarity: presence detected = "1", presence not detected = "0".

Function: Operating mode change-over window status

Object	Function	Name	Type	DPT	Flag
 ³⁴	Window status	R.Input	1-bit	1.019	C, W, -, (R) ¹

Description 1-bit object for the coupling of window contacts. Polarity: Window open = "1", window closed = "0".

Object for operating mode change-over

Function: Operating mode change-over

Object	Function	Name	Type	DPT	Flag
 ³⁵	Heating / cooling switchover ²	R.Input	1-bit	1.100	C, W, T, (R) ¹

Description 1-bit object for specifying the operating mode ("Heating" or "Cooling"). Only visible if "Change-over between heating and cooling = via object".
Object value "1" = Heating; Object value "0" = Cooling.

1: Each communication object can be read out. For reading, the R-flag must be set.

2: This object is only active with one control circuit in the "heating and cooling" or "basic /additional - heating/ cooling" mixed-mode operation.

Function:	Operating mode change-over				
Object	Function	Name	Type	DPT	Flag
 ³⁵	Heating / cooling switchover ¹	R.Output	1-bit	1.100	C, -, T, (R) ²
Description	1 bit object to transmit the automatically set operating mode of the controller. Object value "1" = Heating; Object value "0" = Cooling.				

Object for controller status

Function:	Status signal				
Object	Function	Name	Type	DPT	Flag
 ³⁶	Controller status	R.Output	1 byte	--- ³	C, -, T, (R) ₂
Description	1-byte object used by the controller to output the current state of operation (e.g. to a controller extension). Only when "Controller status" = "Controller general".				

Function:	Status signal				
Object	Function	Name	Type	DPT	Flag
 ⁵⁴	Status signal addition	R.Output	1 byte	--- ⁴	C, -, T, (R) ₂
Description	1-byte object used by the controller to output the current enlarged state of operation (e.g. to a controller extension). Only when "Controller status" = "Controller general".				

Function:	Status signal				
Object	Function	Name	Type	DPT	Flag
 ³⁶	Controller status ...	R.Output	1-bit	1.001	C, -, T, (R) ²
Description	1-bit object for single status feedback of configured controller functions. This object is only available in this way when a part of the controller status is to be transmitted singly as 1-bit information (parameter-dependent).				

1: This object is only active with one control circuit in the "heating and cooling" or "basic /additional - heating/ cooling" mixed-mode operation.

2: Each communication object can be read out. For reading, the R-flag must be set.

3: Non-standardised DP type (in accordance with KNX AN 097/07 rev 3).

4: Non-standardised DP type.

Function:	Status signal				
Object	Function	Name	Type	DPT	Flag
 ³⁶	KNX status operating mode	R.Output	1 byte	20.102	C, -, T, (R) ¹
Description	1-byte object used by the controller to output the current operating mode. This object is generally used to enable controller extensions to display the controller operating mode correctly in the KNX compliant status display. Therefore this object should be connected with controller extensions if the KNX compliant status feedback is not configured. Only when "Controller status" = "KNX compliant".				

Function:	Status signal				
Object	Function	Name	Type	DPT	Flag
 ⁵⁵	KNX status	R.Output	2 byte	22.101	C, -, T, (R) ¹
Description	2-byte object that the controller uses to display elementary basic functions in a KNX-harmonised manner. Only when "Controller status" = "KNX compliant".				

Function:	Status signal				
Object	Function	Name	Type	DPT	Flag
 ⁵⁶	KNX status forced operating mode	R.Output	1 byte	20.102	C, -, T, (R) ¹
Description	1-byte object used by the controller to output the operating mode in the event of forced position. This object is generally used to enable controller extensions to display the controller operating mode correctly in the KNX compliant status display. Therefore this object should be connected with controller extensions if the KNX compliant status feedback is not configured. Only when "Controller status" = "KNX compliant".				

Objects for command value limit

Function:	Command value limit				
Object	Function	Name	Type	DPT	Flag
 ⁵⁷	Command value limit	R.Input	1-bit	1.001	C, W, -, (R) ₁
Description	1-bit object for activating or deactivating the command value limit. Polarity: Limitation activated = "1", Limitation deactivated = "0".				

1: Each communication object can be read out. For reading, the R-flag must be set.

Objects for heating / cooling signal functions

Function:	Status signal				
Object	Function	Name	Type	DPT	Flag
 37	Heating message	R.Output	1-bit	1.001	C, -, T, (R) ₁
Description	1-bit object for the controller to report a request for heating energy. Object value = "1": energy request, object value = "0": no energy request.				

Function:	Status signal				
Object	Function	Name	Type	DPT	Flag
 38	Cooling message	R.Output	1-bit	1.001	C, -, T, (R) ¹
Description	1-bit object for the controller to report a request for cooling energy. Object value = "1": energy request, object value = "0": no energy request.				

Objects for controller disabling functions

Function:	Disabling function (room temperature regulator)				
Object	Function	Name	Type	DPT	Flag
 40	Disable controller	R.Input	1-bit	1.001	C, W, -, (R) ₁
Description	1-bit object for deactivating the controller (activating dew point operation). Polarity: Controller deactivated = "1", controller activated = "0".				

Function:	Disabling function (room temperature regulator)				
Object	Function	Name	Type	DPT	Flag
 41	Disable additional level ²	R.Input	1-bit	1.001	C, W, -, (R) ₁
Description	1-bit object for deactivating the additional level of the controller. Polarity: Additional level deactivated = "1", additional level activated = "0". This object is only available in this way if two-level heating or cooling operation is configured.				

Objects for command value output for heating

Function:	Command value				
Object	Function	Name	Type	DPT	Flag
 42	Command value for heating / command value, basic heating	R.Output	1 byte	5.001	C, -, T, (R) ¹
Description	1-byte object to output the continuous command value of the heating mode. In two-level heating mode, command value output for the basic heating. This object is only available in this way if the type of feedback control is configured to "Continuous PI control".				

1: Each communication object can be read out. For reading, the R-flag must be set.

2: This object is only visible with activated additional stage.

Function:	Command value				
Object	Function	Name	Type	DPT	Flag
 ⁴²	Command value for heating (PWM) / command value, basic heating (PWM)	R.Output	1-bit	1.001	C, -, T, (R) ₁
Description	1-bit object to output the PWM command value of the heating mode. In two-level heating mode, command value output for the basic heating. This object is only available in this way if the type of feedback control is configured to "Switching PI control (PWM)".				

Function:	Command value				
Object	Function	Name	Type	DPT	Flag
 ⁴²	Command value for heating / command value, basic heating	R.Output	1-bit	1.001	C, -, T, (R) ¹
Description	1-bit object to output the switching command value of the heating mode. In two-level heating mode, command value output for the basic heating. This object is only available in this way if the type of feedback control is configured to "Switching 2-point feedback control".				

Object for heating command value output and combined valve heating/cooling

Function:	Command value				
Object	Function	Name	Type	DPT	Flag
 ⁴²	Command value for heating/cooling / basic level	R.Output	1 byte	5.001	C, -, T, (R) ¹
Description	1-byte object to output the combined continuous command value of the heating and cooling mode. In two-level heating/cooling mode, command value output for the basic level This object is only available in this way if the command values for heating and cooling mode are output to a shared object (parameter-dependent). The type of feedback control must also be configured to "Continuous PI control".				

Function:	Command value				
Object	Function	Name	Type	DPT	Flag
 ⁴²	Command value for heating/cooling (PWM) / basic level (PWM)	R.Output	1-bit	1.001	C, -, T, (R) ¹
Description	1-bit object to output the combined PWM command value of the heating and cooling mode. In two-level heating/cooling mode, command value output for the basic level This object is only available in this way if the command values for heating and cooling mode are output to a shared object (parameter-dependent). The type of feedback control must also be configured to "Switching PI control (PWM)".				

1: Each communication object can be read out. For reading, the R-flag must be set.

Function:	Command value				
Object	Function	Name	Type	DPT	Flag
 ⁴²	Command value for heating/cooling / basic level	R.Output	1-bit	1.001	C, -, T, (R) ¹
Description	1-bit object to output the combined switching command value of the heating and cooling mode. In two-level heating/cooling mode, command value output for the basic level This object is only available in this way if the command values for heating and cooling mode are output to a shared object (parameter-dependent). The type of feedback control must also be configured to "Switching 2-point feedback control".				

Object for command value output, additional heating and combined valve additional heating/cooling

Function:	Command value				
Object	Function	Name	Type	DPT	Flag
 ⁴³	Cmd. value, additional heating	R.Output	1 byte	5.001	C, -, T, (R) ¹
Description	1-byte object to output the continuous command value for additional heating in two-level operation. This object is only available in this way if the type of feedback control is configured to "Continuous PI control".				

Function:	Command value				
Object	Function	Name	Type	DPT	Flag
 ⁴³	Cmd. value, add. heating (PWM)	R.Output	1-bit	1.001	C, -, T, (R) ₁
Description	1-bit object to output the continuous PWM command value for additional heating in two-level operation. This object is only available in this way if the type of feedback control is configured to "Switching PI control (PWM)".				

Function:	Command value				
Object	Function	Name	Type	DPT	Flag
 ⁴³	Cmd. value, additional heating	R.Output	1-bit	1.001	C, -, T, (R) ₁
Description	1-byte object to output the switching command value for additional heating in two-level operation. This object is only available in this way if the type of feedback control is configured to "Switching 2-point feedback control".				

Function:	Command value				
Object	Function	Name	Type	DPT	Flag
 ⁴³	Command value, additional level	R.Output	1 byte	5.001	C, -, T, (R) ¹
Description	1-byte object to output the combined continuous command value for additional level in two-level operation. This object is only available in this way if the command values for heating and cooling mode are output to a shared object (parameter-dependent). The type of feedback control must also be configured to "Continuous PI control".				

1: Each communication object can be read out. For reading, the R-flag must be set.

Function:	Command value				
Object	Function	Name	Type	DPT	Flag
 ⁴³	Command value, additional level (PWM)	R.Output	1-bit	1.001	C, -, T, (R) ₁
Description	1-bit object to output the combined switching PWM command value for additional level in two-level operation. This object is only available in this way if the command values for heating and cooling mode are output to a shared object (parameter-dependent). The type of feedback control must also be configured to "Switching PI control (PWM)".				

Function:	Command value				
Object	Function	Name	Type	DPT	Flag
 ⁴³	Command value, additional level	R.Output	1-bit	1.001	C, -, T, (R) ₁
Description	1-bit object to output the combined switching command value for additional level in two-level operation. This object is only available in this way if the command values for heating and cooling mode are output to a shared object (parameter-dependent). The type of feedback control must also be configured to "Switching 2-point feedback control".				

Object for command value output, cooling

Function:	Command value				
Object	Function	Name	Type	DPT	Flag
 ⁴⁴	Command value for cooling / basic cooling	R.Output	1 byte	5.001	C, -, T, (R) ₁
Description	1-byte object to output the continuous command value of the cooling mode. In two-level cooling mode, command value output for the basic cooling. This object is only available in this way if the type of feedback control is configured to "Continuous PI control".				

Function:	Command value				
Object	Function	Name	Type	DPT	Flag
 ⁴⁴	Command value for cooling (PWM) / basic cooling (PWM)	R.Output	1-bit	1.001	C, -, T, (R) ₁
Description	1-bit object to output the PWM command value of the cooling mode. In two-level cooling mode, command value output for the basic cooling. This object is only available in this way if the type of feedback control is configured to "Switching PI control (PWM)".				

1: Each communication object can be read out. For reading, the R-flag must be set.

Function:	Command value				
Object	Function	Name	Type	DPT	Flag
 ⁴⁴	Command value for cooling / basic cooling	R.Output	1-bit	1.001	C, -, T, (R) ¹
Description	1-bit object to output the switching command value of the cooling mode. In two-level cooling mode, command value output for the basic cooling. This object is only available in this way if the type of feedback control is configured to "Switching 2-point feedback control".				

Object for command value output, additional cooling

Function:	Command value				
Object	Function	Name	Type	DPT	Flag
 ⁴⁴	Cmd. value, additional cooling	R.Output	1 byte	5.001	C, -, T, (R) ¹
Description	1-byte object to output the continuous command value for additional cooling in two-level operation. This object is only available in this way if the type of feedback control is configured to "Continuous PI control".				

Function:	Command value				
Object	Function	Name	Type	DPT	Flag
 ⁴⁴	Cmd. value, add. cooling (PWM)	R.Output	1-bit	1.001	C, -, T, (R) ₁
Description	1-bit object to output the continuous PWM command value for additional cooling in two-level operation. This object is only available in this way if the type of feedback control is configured to "Switching PI control (PWM)".				

Function:	Command value				
Object	Function	Name	Type	DPT	Flag
 ⁴⁴	Cmd. value, additional cooling	R.Output	1-bit	1.001	C, -, T, (R) ₁
Description	1-byte object to output the switching command value for additional cooling in two-level operation. This object is only available in this way if the type of feedback control is configured to "Switching 2-point feedback control".				

1: Each communication object can be read out. For reading, the R-flag must be set.

Object for additional PWM heating command value output and combined valve PWM additional heating/cooling

Function:	Command value				
Object	Function	Name	Type	DPT	Flag
 ⁴⁶	PWM command value for heating / PWM command value, basic heating	R.Output	1 byte	5.001	C, -, T, (R) ¹
Description	1-byte object to output the internal continuous command value of a PWM controller of the heating mode. In two-level heating mode, command value output for the basic heating. This object is only available in this way if the type of feedback control is configured to "Switching PI control (PWM)". In addition to the switching 1 bit command value of the PWM, the calculated continuous command value of the controller can also be transmitted to the bus and displayed, e.g. in a visualisation.				

Function:	Command value				
Object	Function	Name	Type	DPT	Flag
 ⁴⁶	PWM command value for heating/cooling / PWM command value, basic level	R.Output	1 byte	5.001	C, -, T, (R) ¹
Description	1-byte object to output the combined continuous command value of a PWM controller of the heating and cooling mode. In two-level heating/cooling mode, command value output for the basic level This object is only available in this way if the command values for heating and cooling mode are output to a shared object (parameter-dependent). The type of feedback control must also be configured to "Switching PI control (PWM)". In addition to the switching 1 bit command value of the PWM, the calculated continuous command value of the controller can also be transmitted to the bus and displayed, e.g. in a visualisation.				

Object for additional command value output, PWM additional heating and combined valve PWM additional heating/cooling

Function:	Command value				
Object	Function	Name	Type	DPT	Flag
 ⁴⁷	PWM cmd. value, add. cooling	R.Output	1 byte	5.001	C, -, T, (R) ¹
Description	1-byte object to output the internal continuous command value of a PWM controller for additional heating in two-level operation. This object is only available in this way if the type of feedback control is configured to "Continuous PI control". In addition to the switching 1 bit command value of the PWM, the calculated continuous command value of the controller can also be transmitted to the bus and displayed, e.g. in a visualisation.				

1: Each communication object can be read out. For reading, the R-flag must be set.

Function:	Command value				
Object	Function	Name	Type	DPT	Flag
 ⁴⁷	PWM command value, additional level	R.Output	1 byte	5.001	C, -, T, (R) ¹
Description	1-byte object to output the combined continuous command value of a PWM feedback controller for additional level in two-level operation. This object is only available in this way if the command values for heating and cooling mode are output to a shared object (parameter-dependent). The type of feedback control must also be configured to "Switching PI control (PWM)". In addition to the switching 1 bit command value of the PWM, the calculated continuous command value of the controller can also be transmitted to the bus and displayed, e.g. in a visualisation.				

Object for additional command value output, PWM cooling and PWM additional cooling

Function:	Command value				
Object	Function	Name	Type	DPT	Flag
 ⁴⁸	PWM command value for cooling / basic cooling	R.Output	1 byte	5.001	C, -, T, (R) ¹
Description	1-byte object to output the internal continuous command value of a PWM feedback controller of the cooling mode. In two-level cooling mode, command value output for the basic cooling. This object is only available in this way if the type of feedback control is configured to "Switching PI control (PWM)". In addition to the switching 1 bit command value of the PWM, the calculated continuous command value of the controller can also be transmitted to the bus and displayed, e.g. in a visualisation.				

Function:	Command value				
Object	Function	Name	Type	DPT	Flag
 ⁴⁹	PWM cmd. value, add. cooling	R.Output	1 byte	5.001	C, -, T, (R) ¹
Description	1-byte object to output the internal continuous command value of a PWM feedback controller for additional cooling in two-level operation. This object is only available in this way if the type of feedback control is configured to "Switching PI control (PWM)". In addition to the switching 1 bit command value of the PWM, the calculated continuous command value of the controller can also be transmitted to the bus and displayed, e.g. in a visualisation.				

1: Each communication object can be read out. For reading, the R-flag must be set.

Object for setpoint temperature specification

Function: Setpoint temperature specification

Object	Function	Name	Type	DPT	Flag
 ⁵⁰	Setpoint temperature	R.Input	2 byte	9.001	C, -, T, R

Description 2-byte object for external setting of the temperature setpoint. Depending on the operating mode, the possible range of values is limited by the configured frost protection and/or heat protection temperature.
The temperature value must always be specified in the format "°C".

Object for basic setpoint shift (only for relative setpoint presetting)

Function: Basic setpoint shift

Object	Function	Name	Type	DPT	Flag
 ⁵²	Current setpoint shift	R.Output	1 byte	6.010	C, -, T, R

Description 1-byte object for giving feedback on the current setpoint shifting. The value of a counter value in the communication object corresponds to the configured interval of the basic setpoint shift. The value "0" means that no shift is active. The value is depicted in a double complement in the positive and negative direction.
This object is only available in this way if relative setpoint presetting is configured.

Function: Basic setpoint shift

Object	Function	Name	Type	DPT	Flag
 ⁵³	Setpoint shift specification	R.Input	1 byte	6.010	C, W, -, (R) ¹

Description 1-byte object for presetting a basic setpoint shift. The value of a counter value in the communication object corresponds to the configured interval of the basic setpoint shift. The value "0" means that no shift is active. The value is depicted in a double complement in the positive and negative direction. In case the limits of the value range are exceeded by the preset external value, the controller will automatically reset the received value to the minimum and maximum limits.
This object is only available in this way if relative setpoint presetting is configured.

1: Each communication object can be read out. For reading, the R-flag must be set.

Object for outputting the actual-temperature

Function: Actual temperature

Object	Function	Name	Type	DPT	Flag
 ⁵⁹	Actual temperature not adjusted	R.Output	2 byte	9.001	C, -, T, R

Description 2-byte object for following-up the determined and unadjusted room temperature value of the internal temperature sensor.
The temperature value is always output in the format "°C".

4.2.3.3 Object table sensors

General

Function:	Temperature				
Object	Function	Name	Type	DPT	Flag
 ⁸⁰	Measured value	S.Temperature	2 byte	9.001	C, -, T, R
Description	2-byte object to output the actual measured value and, if necessary, the compared measured value of the temperature sensor in the ETS. The object can be transmitted if there is a difference between the measured values and/or cyclically.				

Function:	Humidity				
Object	Function	Name	Type	DPT	Flag
 ⁸¹	Measured value	S.Humidity	2 byte	9.007	C, -, T, R
Description	2 byte object for outputting the current measured value of the humidity sensor. The object can be transmitted if there is a difference between the measured values and/or cyclically.				

Function:	CO ₂				
Object	Function	Name	Type	DPT	Flag
 ⁸²	Measured value	S.CO ₂	2 byte	9.008	C, -, T, R
Description	2 byte object for outputting the current measured value of the CO ₂ sensor. The object can be transmitted if there is a difference between the measured values and/or cyclically.				

Function:	Dew point				
Object	Function	Name	Type	DPT	Flag
 ⁸³	Temperature	S.Dew point	2 byte	9.001	C, -, T, R
Description	2-byte object to output the current, calculated dew point value. The object can be transmitted if there is a difference between the measured values and/or cyclically.				

Limiting values

Function:	Limiting values				
Object	Function	Name	Type	DPT	Flag
 ^{85, 88}	Limiting value 1, 2	S.Humidity	1-bit	1.001	C, -, T, R
Description	1 bit objects for outputting the current limiting values of the humidity sensor. The object can be transmitted if there is a change in value and/or cyclically. Switch-on and switch-off delay is parameterizable.				

Function:	Limiting values				
Object	Function	Name	Type	DPT	Flag
 86, 89, 90, 91	Limiting value 1, 2, 3, 4	S.CO2	1-bit	1.001	C, -, T, R
Description	1 bit objects for outputting the current limiting values of the CO ₂ sensor. The object can be transmitted if there is a change in value and/or cyclically. Switch-on and switch-off delay is parameterizable.				

External limiting values

Function:	External limiting values				
Object	Function	Name	Type	DPT	Flag
 93, 96	Absolute value	S.Humidity limiting value spec. 1, 2	2 byte	9.007	C, W, -, (R) ¹
Description	2-byte objects for specifying the external limiting values for the humidity by an absolute value.				

Function:	External limiting values				
Object	Function	Name	Type	DPT	Flag
 93, 96	Percentage	S.Humidity limiting value spec. 1, 2	1 byte	5.001	C, W, -, (R) ¹
Description	1-byte objects for specifying the external limiting values for the humidity by a percentage.				

Function:	External limiting values				
Object	Function	Name	Type	DPT	Flag
 93, 96	Learning	S.Humidity limiting value spec. 1, 2	1-bit	1.001	C, W, -, (R) ¹
Description	1-byte objects for storing the external limiting values for the humidity via a switching object (teaching)				

Function:	External limiting values				
Object	Function	Name	Type	DPT	Flag
 94, 97, 98, 99	Absolute value	S.CO2 limiting value spec. 1, 2, 3, 4	2 byte	9.008	C, W, -, (R) ¹
Description	2-byte objects for specifying the external CO ₂ limiting values by an absolute value.				

Function:	External limiting values				
Object	Function	Name	Type	DPT	Flag
 94, 97, 98, 99	Percentage	S.CO2 limiting value spec. 1, 2, 3, 4	1 byte	5.001	C, W, -, (R) ¹
Description	1-byte objects for specifying the external CO ₂ limiting values by a percentage.				

1: Each communication object can be read out. For reading, the R-flag must be set.

Function: External limiting values

Object	Function	Name	Type	DPT	Flag
 94, 97, 98, 99	Learning	S.CO2 limiting value spec. 1, 2, 3 ,4	1-bit	1.001	C, W, -, (R) ¹

Description 1-byte objects for storing the external CO₂ limiting values via a switching object (teaching).

Alarms / messages

Function: Dew point

Object	Function	Name	Type	DPT	Flag
 108	Switching	S.Dew point alarm / S.Dew point alarm 1	1-bit	1.001	C, -, T, R

Description 1-bit output object for transmitting a dew point alarm (switching command).

Function: Dew point

Object	Function	Name	Type	DPT	Flag
 108	Value	S.Dew point alarm / S.Dew point alarm 1	1 byte	5.001	C, -, T, R

Description 1-byte output object for transmitting a dew point alarm (value).

Function: Dew point

Object	Function	Name	Type	DPT	Flag
 109	Switching	S.Dew point alarm 2	1-bit	1.001	C, -, T, R

Description 1-bit output object for transmitting a dew point alarm (switching command).

Function: Dew point

Object	Function	Name	Type	DPT	Flag
 109	Value	S.Dew point alarm 2	1 byte	5.001	C, -, T, R

Description 1-byte output object for transmitting a dew point alarm (value).

Function: Temperature

Object	Function	Name	Type	DPT	Flag
 110	Sensor fault	S.Temperature	1-bit	1.001	C, -, T, R

Description 1-bit output object for signalling a fault in the temperature sensor.

1: Each communication object can be read out. For reading, the R-flag must be set.

Function: Humidity

Object	Function	Name	Type	DPT	Flag
 ¹¹¹	Sensor fault	S.Humidity	1-bit	1.001	C, -, T, R

Description 1-bit output object for signalling a fault in the humidity sensor.

Function: CO₂

Object	Function	Name	Type	DPT	Flag
 ¹¹²	Sensor fault	S.CO2	1-bit	1.001	C, -, T, R

Description 1-bit output object for signalling a fault in the CO₂ sensor.

4.2.3.4 Object table logic gates

Logic gates

Function: Inputs of the logic gates					
Object	Function	Name	Type	DPT	Flag
 115, 116, 117, 118, 121, 122, 123, 124, 127, 128, 129, 130, 133, 134, 135, 136	Input / Input 1 - 4	L.Logic gate 1 - 4	1-bit	1.001	C, W, -, (R) ¹
Description	1-bit objects for activation of the logical inputs of the logic gates. Depending on the parameterisation, the inputs can be linked normally inverted 'AND', 'OR', 'exclusive OR' as well as 'AND with return'.				

Function: Outputs of the logic gates					
Object	Function	Name	Type	DPT	Flag
 119, 120, 125, 126, 131, 132, 137, 138	Output switching / Output 1 - 4 switching	L.Logic gate 1 - 4	1-bit	1.001	C, -, T, (R) ¹
Description	1 bit output objects of the logic gates.				

Function: Outputs of the logic gates					
Object	Function	Name	Type	DPT	Flag
 119, 120, 125, 126, 131, 132, 137, 138	Output value / Output 1 - 4 value	L.Logic gate 1 - 4	1 byte	5,010	C, -, T, (R) ¹
Description	1 byte output objects of the logic gates. A value from 0 ... 255 can be assigned to each logic operation result and output.				

1: Each communication object can be read out. For reading, the R-flag must be set.

4.2.4 Functional description

4.2.4.1 Application basics

Combination sensors that measure physical measured values at the installation location are integrated in the device. In this way, the CO₂ content of the ambient air as well as the temperature and humidity in a room can be measured and the measured values compared as well. From the measured temperature and air humidity values the dew point can be calculated, which is further processed in the device and can also be transmitted to the bus if necessary. The measured values of the physical sensor are output on the bus via separate communication objects. The integrated room temperature controller is operated entirely via communication objects. Indicators and controls are not present on the device. Two push-button/switching states can be read potential-free via both binary inputs, and depending on this, telegrams can be transmitted to the bus.

The device is flush mounted in a switchbox and covers the surface of a socket. The device is a so-called monoblock product. It does not require any separate bus coupling or additional power supply.

In rooms frequented by many people, such as conference rooms, meetings or classrooms, the CO₂ concentration can increase rapidly. People emit carbon dioxide into the air when they exhale. The outside air normally inhaled contains about 21 % oxygen and 0.035 % carbon dioxide. The exhaled air contains about 16 % oxygen and 4 % carbon dioxide. Even though carbon dioxide first becomes extremely life threatening from a concentration of about 20 %, the well-being, power of concentration and physical fitness already becomes impaired from 0.08 %, which is first unnoticeable for the person affected, however.

Hence, various standards recommend a maximum value of 0.1 % carbon dioxide in the room air. In view of today's building situation and high air tightness of the building shell, this value is very often exceeded. The result: as from a ratio of 1,000 ppm (0.1%), people become tired, lack concentration and subsequently complain of a headache. In the case of higher concentrations, increased heart beat, shortness of breath and unconsciousness occur (the so-called CO₂ anaesthesia). CO₂ concentrations of 8 percent and more can cause death within 30 to 60 minutes.

Automatic monitoring of the air quality and automatically controlled ventilation can prevent this effect. The work area of the CO₂ sensor is between 0% and 0.2% because rooms with these CO₂ concentrations should already be ventilated (Figure 7).

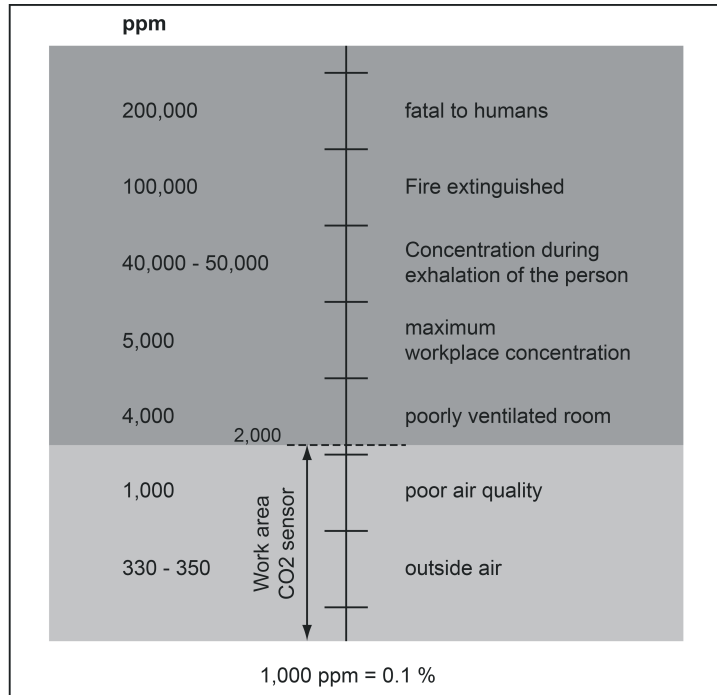

Figure 7: CO₂ concentration

4.2.4.2 Push button interface

4.2.4.2.1 Introduction

The device incorporates the function of a 2-gang push-button interface, i.e. it has two independent binary inputs. The push-button interface permits up to two potential-free push-button/switching states with common reference potential to be read and evaluated. The device is fitted with a 3-pin terminal strip for the binary inputs.

It is possible to specify separately for each input whether and which reactions should take place on signal edges and after bus voltage return. This means that a defined telegram can be transmitted to the bus according to the input signal or with forced control. The configured "Delay after reset or bus voltage return" must first have elapsed before the pre-set reaction is executed. Within the delay, any pending edges or signals at the inputs are not evaluated and are discarded. The delay time is configured generally for all the inputs.

It is also possible to configure a general telegram rate limit. In this case, no telegram is transmitted within the first 17 s after bus voltage return.

It should be noted that the configured "Delay after reset or bus voltage return" is also active during this time and the configured behaviour is not executed after bus voltage return if the delay time elapses within the first 17 seconds.

The telegram rate limit is configurable globally for all inputs. The telegram rate limit has no influence on the telegrams of the room temperature controller function, sensor measured values, limiting values or logic gates.

4.2.4.2.2 Function "no function"

If the function of an output is configured to "No function", the device deactivates the input channel completely. Consequently, all respective communication objects are hidden in the ETS.

4.2.4.2.3 Switching function

If the function of the input is configured to "Switching", the parameters "Command on rising edge" and "Command on falling edge" are visible for two separate switching objects.

The selectable switching commands are "OFF", "ON" or "TOGGLE". "TOGGLE" will switch and transmit the value, which is stored in the switching object. In addition, the transmission of a switching command may be suppressed (setting "no reaction").

Optionally, cyclical transmission can be activated by the parameter of the same name. The internally or externally tracked object value in the switching objects is always transmitted. The object value is then also transmitted cyclically when "no reaction" is assigned to a rising or falling edge.

Cyclical transmission always occurs immediately after bus voltage return if the configured value of the telegram after bus voltage return corresponds to the object value configuration for cyclical transmission. If telegram rate limit is enabled, the cyclical transmission occurs after 17 seconds at the earliest.

During an active disable, no cyclical transmissions take place via the disabled input.

4.2.4.2.4 Dimming function

If the function of the input is configured to "Dimming", various parameters for the dimming function and the "Switching" and "Dimming" objects are visible.

The "Operation" parameter determines whether this channel ("Single-surface operation") alone is used or in conjunction with the another channel ("double-surface operation"). The switching or dimming commands, which should be transmitted to the bus in the case of a positive signal edge, are also defined here. The executable commands are "Darker (OFF)", "Brighter (ON)" or "TOGGLE".

In the "Darker (OFF)" setting, an OFF telegram is triggered in the case of a short signal edge, and a dimming telegram (darker) is triggered in the case of a long signal edge.

In the "Brighter (ON)" setting, an ON telegram is triggered in the case of a short signal edge, and a dimming telegram (brighter) is triggered in the case of a long signal edge.

In the "TOGGLE" setting, the switching state stored internally in the switching object is toggled in the case of a short signal edge.

In addition, the dimming increments can be adjusted for "increasing and decreasing brightness" and the "time between switching and dimming ". A "stop telegram" can also be released at the end of the dimming operation (telegram transmission on releasing the push button).

If the parameter "telegram repetition" is set to "Yes", dimming telegrams can be transmitted cyclically during an active signal edge. The "time between two dimming telegrams" is adjustable. In each case this time has elapsed, a new dimming telegram is issued with the parameterized dimming increment.

4.2.4.2.5 Venetian blind function

If the function of the input is configured to "Venetian blind", various parameters for the Venetian blind function and the "Short time operation" and "Long-time operation" objects are visible. The "operation concept" parameter predefines the telegram sequence for short and long-time telegrams that are transmitted with or during key actuation.

For controlling the Venetian blind, shutter or awning operations the push button interface is supported by two operation concepts, in which the telegrams are transmitted with a different time sequence. Therefore a wide variety of drive configurations can be operate. The different operation concepts are described in detail in the following chapters.

Operation concept "short – long – short":

In the operation concept "short – long – short", the input shows the following behaviour...

- Immediately after a rising edge the device transmits a short time telegram. Pressing the button stops a running drive and starts time T1 ("time between short time and long time command"). No other telegram will be transmitted, if the key is released within T1. This short time serves the purpose of stopping a continuous movement. The "time between short time and long time command" should be selected shorter than the short time operation of the actuator to prevent a jerky movement of the blind.
- If the button is kept depressed longer than T1, the device transmits a long time telegram after the end of T1 for starting up the drive and time T2 ("slat adjusting time") is started.
- If a falling edge is detected within the slat adjustment time, the device transmits an additional short time telegram. This function is used for adjusting the slats of a blind. The function permits stopping the slats in any position during their rotation. The "slat adjusting time" should be chosen as required by the drive for a complete rotation of the slats.
- If the "slat adjusting time" is selected longer than the complete running time of the drive, a push button function is possible as well. In this case, the driver only remains on while the button is kept depressed at the input. If the button is kept depressed longer than T2, the device transmits no further telegram. The drive remains on until the end position is reached.

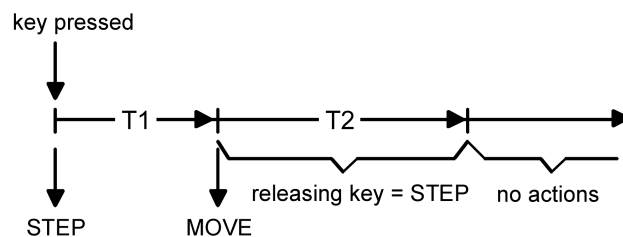

Figure 8: Operation concept "short – long – short"

Operation concept "long – short":

In the operation concept "long – short", the input shows the following behaviour...

- Immediately after a rising edge the device transmits a long time telegram. The drive begins to move and time T1 ("slat adjusting time") is started.
- If a falling edge is detected within the slat adjustment time, the device transmits a short time telegram. This function is used for adjusting the slats of a blind. The function permits stopping the slats in any position during their rotation. The "slat adjusting time" should be chosen as required by the drive for a complete rotation of the slats. If the "slat adjusting time" is selected longer than the complete running time of the drive, a push button function is possible as well. In this case, the driver only remains on while the button is kept depressed at the input.
- If the button is kept depressed longer than T1, the device transmits no further telegram. The drive remains on until the end position is reached.

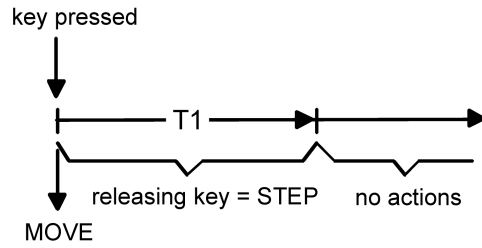

Figure 9: Operation concept "long - short"

The parameter "Command on rising edge" specifies which polarity the telegrams have for long or short-time operation. The executable commands are "UP", "DOWN" or "TOGGLE".

4.2.4.2.6 Function "Value transmitter 1 byte / 2 byte"

For each input whose function is set to "Value transmitter", the ETS indicates either a 1-byte or a 2-byte object. The data format of the value object is dependent on the set function of the value transmitter. The "Function as" defines the function on one of the following value transmitter applications...

- Dimming value transmitter (1-byte),
- Temperature value transmitter (2-bytes),
- Brightness value transmitter (2-bytes),
- Light scene extension without memory function (1-byte),
- Light scene extension with memory function (1-byte).

The dimming value transmitter, temperature and brightness value transmitter different in data format and in the range of values. The independent function of the light scene extension is special and is described .

Dimming value transmitter, temperature and brightness value transmitter

In the function as a dimming value transmitter, the input can transmitted unformatted integers in the range 0 ... 255 to the bus. As a brightness value transmitter, the input transmits formatted floating point values in the range 0 ... 1500 Lux and, as a temperature value transmitter, in the range 0 ... 40 °C. Table 1 shows a summary of the value ranges of the value transmitters. The values to be transmitted are configured in the ETS and can be adjusted later during device operation (see value adjustment below).

The edge evaluation of the device means that it can transmit values only on a rising edge, only on a falling edge or on a rising and falling edge. In this way, it is possible to make adjustments to the contact connected at the input (pushbutton as NC contact or NO contact and switch).

Value transmitter type	Function	Lower numerical limit	Upper numerical limit
Dimming value transmitter	0 ... 255	0	255
Temperature value transmitter	Temperature value	0 °C	40 °C
Brightness value transmitter	Brightness value	0 lux	1.500 lux

Table 1: Value ranges of dimming value transmitter, temperature and brightness value transmitter

Value adjustment for dimming value transmitter, temperature and brightness value transmitter

In the dimming value transmitter and temperature and brightness value transmitter, an adjustment of the value to be transmitted during device operation can be configured. A value adjustment can only be configurable in the ETS when the value is to be transmitted only on a rising edge or only on a falling edge, i.e. a pushbutton is connected to the input.

A value adjustment is introduced by a long signal at the input (> 5 s) and continues for as long as the signal is detected as active, i.e. the pushbutton is actuated. With the first adjustment after commissioning, the value programmed by the ETS is increased cyclically by the step width configured for the dimming value transmitter and transmitted. The step width of the temperature value transmitter (1K) and the brightness value transmitter (50 Lux) is permanently defined. The previously transmitted value is saved after releasing the pushbutton. The next long pushbutton actuation adjusts the saved value and the direction of the value adjustment changes.

The time between two telegrams on adjusting values can be configured in the ETS.

Example of value adjustment (Figure 10):

- Function as dimming value transmitter
- Transmit value on = Rising edge

- Value configured in the ETS for rising edge = 17
- Step width = 5

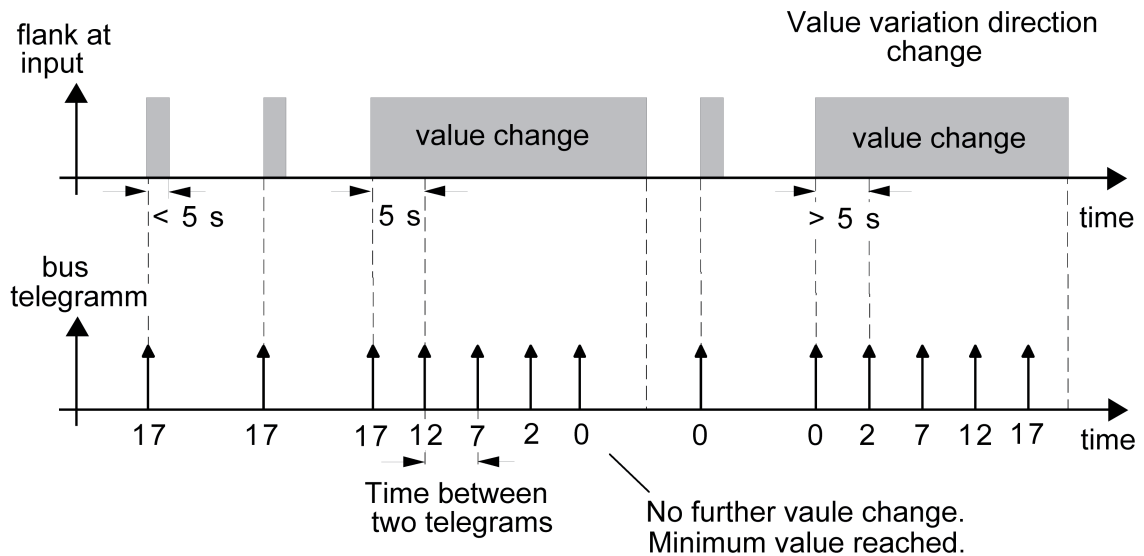

Figure 10: Example to change the value for dimming value transmitter

- i** There is no value over- or underrun on adjustment. If, during an adjustment, the maximum or minimum value is reached (see Table 1), no more telegrams are transmitted.
- i** To ensure that, during a value adjustment, for example the controlled lighting switches off or switches on at the maximum, the limit values (e.g. the values "0" or "255") are always transmitted when the limits of the adjustable range are reached. This also takes place when the configured step width of these values is not immediately taken into account (see example above: step width = 5; value "2" is transmitted, then value "0"). In this case, to ensure that the original starting value can be reset on resetting with a change to the adjustment direction, the first value jump is not equal to the preset step width (see example above: step width = 5; value "0" is transmitted, then values "2"; "7" etc.).
- i** The newly adjusted values are stored in RAM. After a device reset (bus voltage failure or ETS programming operation), the adjusted values are replaced by the values originally configured in the ETS.

4.2.4.2.7 Function "Light scene extension with/without memory function"

With a configuration as a light scene extension without a memory function, it is possible to recall a light scene. With a rising, falling or rising and falling edge, the light scene number configured in the ETS is immediately transmitted to the bus.

With a configuration as a light scene extension with a memory function, it is possible to generate a memory telegram according to the light scene to be transmitted. For this, the appropriate memory telegram is transmitted for a long signal according to the configured edge evaluation (pushbutton as NC contact or NO contact - not as switch!). In this case, the time for long actuation can be configured (but not to below 5 s). With short actuation < 1 s, the configured light scene number (without memory telegram) is transmitted. If the actuation last longer than 1 s but less than 5 s, no telegram is triggered.

In addition, there is the option of only transmitting a memory telegram without prior light scene recall. In this case, the parameter "Only memory function ?" must be set to "Yes".

Examples for a light scene extension with memory function

- 1.) Only memory function = No
- 2.) Only memory function = Yes

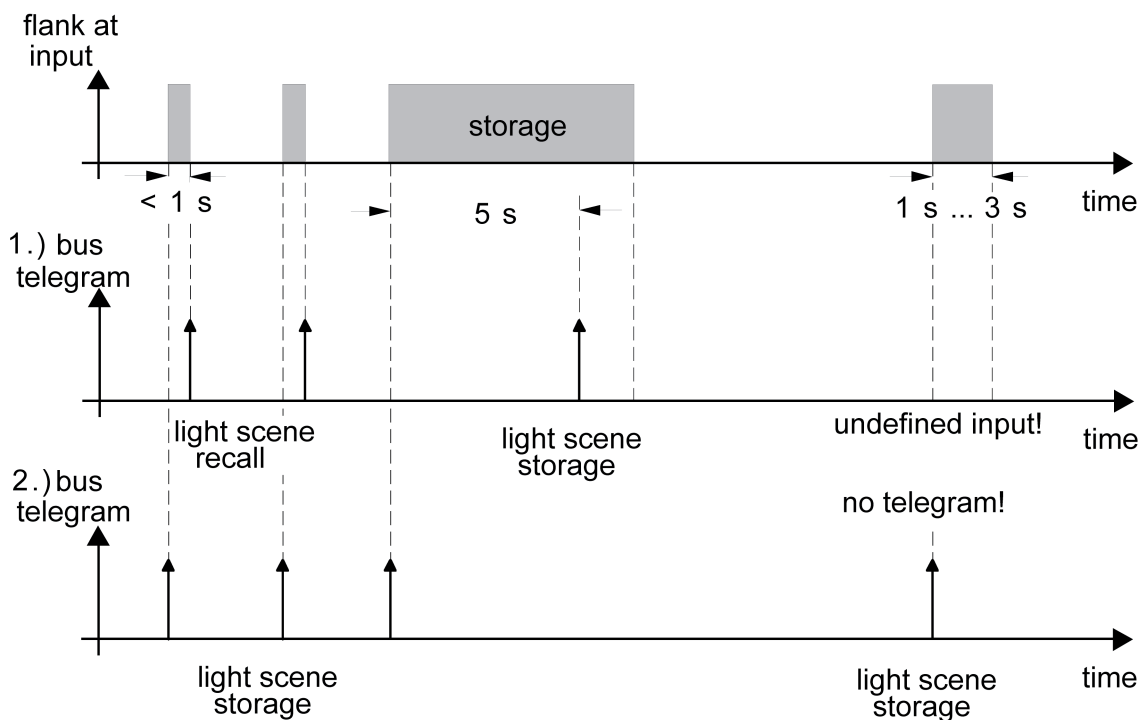

Figure 11: Example of scene storage

"Only memory function = No":

If a rising or falling edge is detected at the input (according to the configuration), the time recording operation begins. If actuation ceases during the first second, the appropriate light scene recall takes place immediately. If the signal length is longer, then the memory telegram is transmitted after 5 s.

"Only memory function = Yes":

The memory telegram is transmitted immediately after detection of the appropriate signal edge.

4.2.4.2.8 Response to bus voltage return

It is possible to specify separately for each input whether or which reaction should take place after bus voltage return. This means that a defined telegram can be transmitted to the bus according to the input signal or with forced control.

The configured "Delay after reset or bus voltage return" must first have elapsed before the pre-set reaction is executed!

Within the delay, any pending edges or signals at the inputs are not evaluated and are discarded. The delay time is configured generally for all the inputs.

A general telegram rate limit is configurable. In this case, no telegram is transmitted within the first 17 s after bus voltage return.

It should be noted that the configured "Delay after bus voltage return" is also active during this time and the configured behaviour is not executed after bus voltage return if the delay time elapses within the first 17 seconds!

- i The communication objects of the room temperature controller function, sensor, limiting values and logic gates are independent of the configured delay time.
- i The option "transmit current input state" of the push-button functions "switching" and "value transmitter" for the behaviour after bus voltage return evaluates an open switching contact as a falling edge and a closed switching contact as a rising edge. The current input state of the input is transmitted according to the configuration for the rising or falling edge.

4.2.4.2.9 Disabling function of the Inputs

A specific reaction can be executed independently for each input at the beginning and end of a disable.

In so doing, it is possible to configure to "No reaction". Only in this case are dimming or venetian blind control operations or value adjustments completed during an active disable. In all other cases, the configured command is transmitted instantly at the beginning of the disable.

Furthermore, edges or signals on the corresponding inputs are not evaluated during an active disable! Updates on disabling objects (disable or enable) cause the transmission every time of the corresponding configured command "at the beginning or end of the disable".

- i For "switching" function: During an active disable, no cyclical transmissions take place via the disabled input. If a cyclical transmission took place prior to activating the disabling function, no cyclical transmission will take place any more at the end of the disable in the configuration "no reaction". In this case, the object value is first transmitted cyclically again after an update on the switching object. In all other cases, the object value is transmitted cyclically again after the end of the disable.

4.2.4.3 Sensor function

4.2.4.3.1 Temperature sensor

Basic principles

The temperature sensor of the device measures the actual temperature of the room cyclically. The measured value can be transmitted instantly to the bus via a separate 2-byte object, and thus be made available to KNX display components. The temperature sensor is also used for the integrated room temperature controller for measuring the room temperature. The control algorithm calculates the adjusted command value from the difference between actual and setpoint temperatures.

Further information concerning the room temperature measurement of the controller can be looked up in the corresponding chapter of this product documentation (see page 97).

The temperature sensor is integrated in the room temperature controller. Alternatively (e.g. if the room temperature controller has been installed in an unfavourable location or operates in difficult conditions, for example, in a moist atmosphere) or in addition (e.g. in large rooms or halls), a second temperature sensor linked via bus telegrams can be used to determine the actual value. This second sensor can either be a room temperature controller coupled via the KNX or a controller extension with temperature recording.

Installation location

When choosing the installation location of the controller or the external sensor, the following points should be considered...

- The temperature sensor should not be used in multiple combinations, especially together with concealed dimmers.
 - Do not install the temperature sensor in the area of large electrical consumers (avoid heat influences).
 - The push button sensor should not be installed in the vicinity of radiators or cooling systems.
 - The temperature sensor should not be exposed to direct sun.
 - The installation of sensors on the inside of an outside wall might have a negative impact on the temperature measurement.
 - Temperature sensors should be installed at least 30 cm away from doors, windows or ventilation units and at least 1.5 m above the floor.
- i** Since all parameters are oriented by the room temperature measured by the temperature sensor, the exact temperature measurement is an essential component of the room temperature controller.
- i** Room temperature measurement by the device is always active, irrespective of the "Room temperature control" function and can thus be used independently (e.g. for simple measurement and display of a room temperature without control).

Behaviour in case of sensor faults

The device monitors the integrated, digital, combination sensors cyclically. If communication is permanently impaired (e.g. due to a sensor or device fault), the corresponding alarm object "sensor fault" is written with the value "ON" for the fault message and a telegram is transmitted to the bus.

The sensor is deactivated by the device during a fault. Afterwards, an attempt is made to cyclically reactivate the sensor. If this is achieved reliably after a certain amount of time, the device resumes measuring the physical values and also resets the sensor fault message by an "OFF" telegram. In case of an impaired and deactivated sensor, the value "0" is output as measured value.

- i** After a device reset (programming with the ETS, bus voltage return) the objects "sensor fault" are updated according to the current state and telegrams are transmitted to the bus.

4.2.4.3.2 Humidity sensor

General

A combination sensor, which enables a measurement of the relative air humidity, is integrated in the device. The measured value can be transmitted instantly to the bus via a separate 2-byte object, and thus be made available to KNX display components. The measured value is also used for calculating the dew point.

- Measuring range... 10 ... 95 % rel. humidity (%RH)
- Work area... 0 ... 95 % (non-condensing)

Humidity measurement

The humidity sensor measures the humidity in the room cyclically, which serves to improve the indoor climate. A relative air humidity between 40% and 60% is recommended as a comfort range for offices and working areas.

To ensure that an accurate value is constantly determined for the relative humidity, it is very important to also measure the exact temperature of the room air in addition to the humidity value. For this purpose, the determined room temperature value, and if necessary, the room temperature value adjusted by ETS parameters is used, whereby the self-heating of the sensor is compensated among other things.

Furthermore, the value of the relative air humidity is necessary for calculating the dew point. With the aid of the dew point and dew point alarms, the condensation of humidity can be prevented on cold thermal bridges.

Dew point

The dew point temperature is calculated by the device on the basis of the determined room temperature. Digital sensors as used in this device, for example, provide the basis for this. The determined humidity value of the sensor is adjusted by means of the Magnus formula which is an approximation formula for calculating the saturated vapour pressure depending on the temperature. It is very accurate (< 0.22 %) in the range between 0°C and 100°C and is primarily used in meteorology and building physics for determining the dew point.

Before reaching the dew point temperature, an alarm object can be switched, which activates the room ventilation, for example. The temperature difference before reaching the dew point temperature, i.e. the alarm threshold, is set via the parameter "Lead dew point alarm". The switch-off hysteresis defines the temperature value below the alarm threshold at which point the dew point alarm is deactivated again.

It is possible to select whether one or two alarm objects should be used. The data format of the alarm object can be selected between 1-bit and 1-byte.

Behaviour in case of sensor faults

The device monitors the integrated, digital, combination sensors cyclically. If communication is permanently impaired (e.g. due to a sensor or device fault), the corresponding alarm object "sensor fault" is written with the value "ON" for the fault message and a telegram is transmitted to the bus.

The sensor is deactivated by the device during a fault. Afterwards, an attempt is made to cyclically reactivate the sensor. If this is achieved reliably after a certain amount of time, the device resumes measuring the physical values and also resets the sensor fault message by an "OFF" telegram. In case of an impaired and deactivated sensor, the value "0" is output as measured value.

- i** After a device reset (programming with the ETS, bus voltage return) the objects "sensor fault" are updated according to the current state and telegrams are transmitted to the bus.

4.2.4.3.3 CO2 sensor

General

A CO₂ sensor can be useful in all cases where CO₂ develops in enclosed spaces. In some countries, a CO₂ sensor is already compulsory in schools. This CO₂ sensor is designed exactly for this purpose and can also be used for controlling automatic room ventilation available on site.

The power supply of the CO₂ sensor is supplied via the bus.

Functional description

After connecting the bus voltage of after bus voltage return, the CO₂ sensor starts measuring the CO₂ concentration of the room air. The measured values are transmitted to the bus. If adjustable limiting values are exceeded within the range from 0...2000 ppm, specific actions can be triggered (e.g. room ventilation). The 4 limiting values are preset as follows: 400 ppm for very good air quality, 800 ppm for good air quality, 1,200 ppm for medium air quality and 1,600 ppm for poor air quality.

CO₂ sensor module

The integrated CO₂ sensor module is responsible for measuring the CO₂. It is maintenance-free due to the automatic calibration method (dual beam measuring cell). It has excellent long-term stability.

- i** After switch-on, the CO₂ sensor module requires a warm-up period of up to 5 minutes, until normal operation is reached.
The automatic calibration method is only available in the case of permanent bus voltage and after 24 hours for the first time.

Sensor data of the CO₂ sensor module

- Measuring range... 0..2000 ppm
- Accuracy (when 25 °C and 1013 mbar)... <± 50 ppm (+2% of the measured value)
- Temperature dependency... type. 2 ppm / K (0 ... 50 °C)
- Response time... <5 min

Air pressure

The measured value of the CO₂ sensor is air pressure dependent. As the air pressure increases, so does the measured value. The parameter "height of location above sea level" is provided in order to compensate for this dependency. The current height of the location (in meters above sea level) can be parameterised using this parameter. The installation height is adjusted in 1m increments.

h [m a.s.l.]	Δp [hPa]	h [m a.s.l.]	Δp [hPa]
100	12.0	1100	125.4
200	23.8	1200	136.1
300	35.5	1300	146.8
400	47.2	1400	157.3
500	58.7	1500	167.7
600	70.1	1600	178.1
700	81.3	1700	188.3
800	92.5	1800	198.4
900	103.6	1900	208.4
1000	114.5	2000	218.4

Figure 12: Pressure increase depending on the height of location

Behaviour in case of sensor faults

The device monitors the integrated, digital, combination sensors cyclically. If communication is permanently impaired (e.g. due to a sensor or device fault), the corresponding alarm object "sensor fault" is written with the value "ON" for the fault message and a telegram is transmitted to the bus.

In the case of a fault, the CO₂ sensor is deactivated permanently by the device for safety reasons. In case of an impaired and deactivated sensor, the value "0" is output as measured value.

- i** After a device reset (ETS programming operation or bus voltage return), the CO₂ sensor is restarted again. If there is no fault anymore, the device resumes measuring the CO₂ concentration of the room air and updates the object "Sensor fault" with "OFF". Should the sensor still be impaired after a reset, the device deactivates the sensor and transmits the value "ON" to the bus via the alarm object "Sensor fault".

4.2.4.3.4 Limiting values

Four limiting values can be assigned to the CO₂ measured value and two limiting values to the humidity measured value. This makes it possible to trigger actions when the adjustable limits are exceeded or undershot. Thus, if there is a certain CO₂ content in the room air, for example, ventilation can be activated or warning messages generated.

Types of limiting value specification

The value of a limiting value itself can be specified in three ways.

- Limiting value specification via the parametrization.
This is the value configured in the ETS, which comes into effect after the initialisation or after a download. This value can be overwritten via an external object or the teaching function. In this case, the internal value is first reactivated after downloading the project once again.
 - Limiting value specification via an external object.
This external value overwrites permanently the value of the limiting value specification via the parametrization. In this case, the internal value is first reactivated after downloading the project once again.
 - Limiting value specification via the teaching function.
This function makes it possible to define the current measured value as the limiting value by pressing an external pushbutton. This value overwrites permanently the value of the limiting value specification via the parametrization. In this case, the internal value is first reactivated after downloading the project once again.
- i** If the internal value of the limiting value specification is overwritten by parameterization at any point, this value will remain lost until a new download is performed via the ETS.

Setting limiting value specification via parametrization

The limiting value specification for the measured values "CO₂" and "Humidity" are set by means of the parameters "Limiting value X" in the parameter node "Limiting value X".

"n limiting values active" is set for the measured value on the parameter page "CO₂ measurement" or "humidity measurement". There is a maximum of four (n = 1...4) limiting values available for the CO₂ measured value, and a maximum of two (n = 1...2) for the humidity measured value.

- Enter the required value in the input field "Limiting value X".

i This value is loaded to the device during initialization and renewed download.

i The set value is retained until it is overwritten by an external value.

Hysteresis of the limiting values

The device has four limiting values for the CO₂ measured value, and two limiting values for the humidity measured value. Each limiting value has an adjustable hysteresis and a definition of the response when the value is exceeded or undershot. The hysteresis itself serves to prevent frequent switching backwards and forwards when there is a measured value in the approximate area of the limiting value. This, for example, prevents a fan from constantly being switched on and off. The hysteresis values should therefore be chosen as large as possible. These circumstances are explained in the following diagrams.

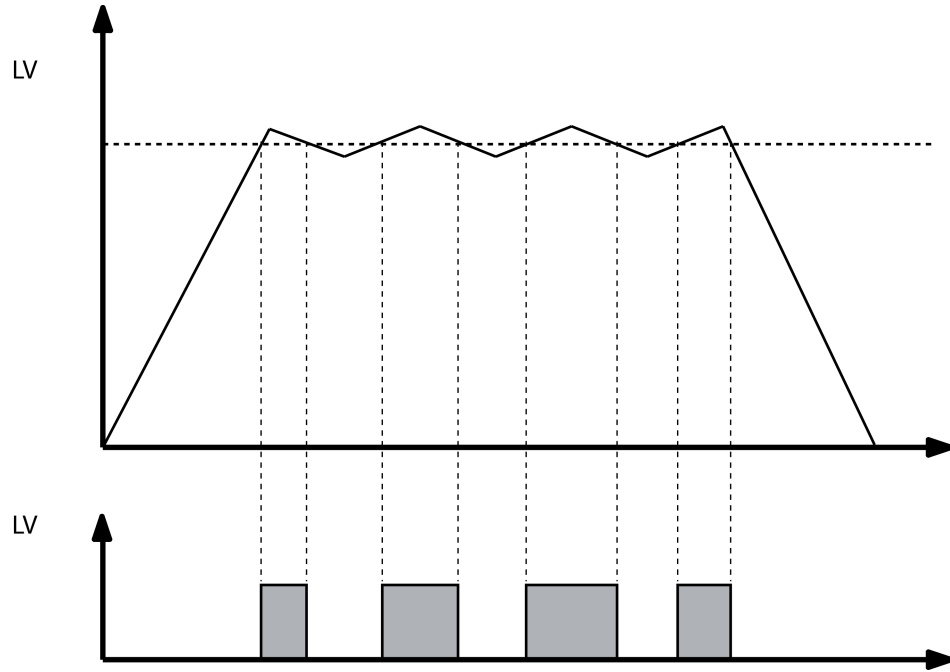

Figure 13: Frequency of switching without hysteresis

One can see here that when no hysteresis is incorporated the limiting value object changes its state each time the value is undershot or exceeded. This is different if you parameterise a change of state from '1' to '0' only when the limit value is undershot by the measured value minus hysteresis.

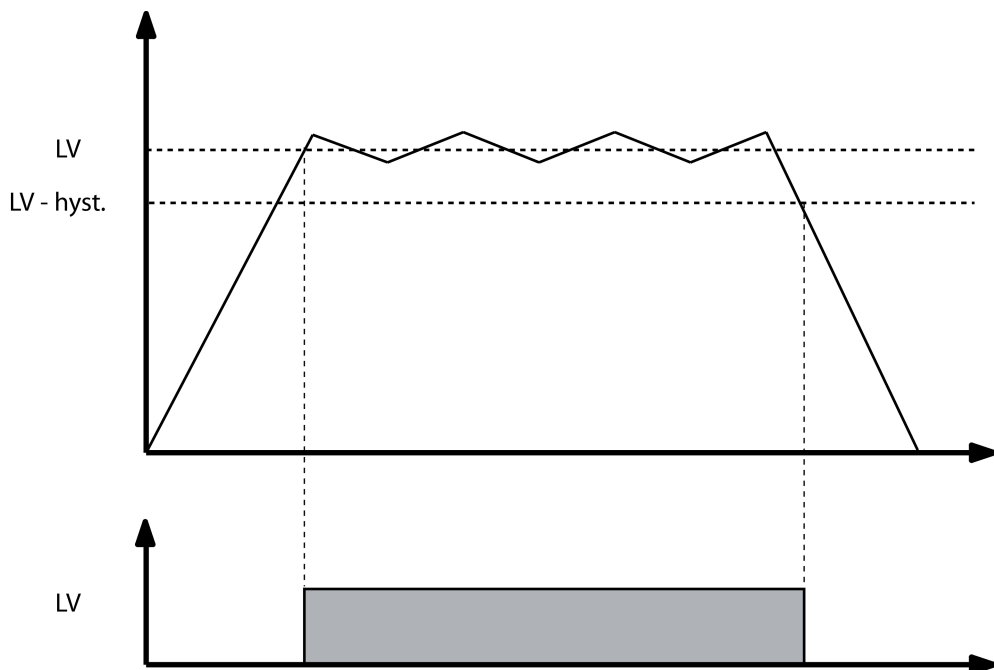

Figure 14: Frequency of switching with hysteresis parameterised.

- i** The hysteresis must be selected in such a way that the start of the measurement range is not reached or undershot and the end value is not reached or exceeded, as otherwise a change of state can only occur once and not any more until a reinitialisation.

Setting the hysteresis of the limiting value

The hysteresis of the limiting values for the measured values "CO₂" and "Humidity" is set by means of the parameters "Limiting value X" in the parameter node "Limiting value X".

"n limiting values active" is set for the measured value on the parameter page "CO₂ measurement" or "humidity measurement". There is a maximum of four (n = 1...4) limiting values available for the CO₂ measured value, and a maximum of two (n = 1...2) for the humidity measured value.

- Enter the appropriate value in the input field "Hysteresis".
The hysteresis is set.

Response of the limiting value object when the limiting value is exceeded and undershot

For the parameter "Activation limiting value X" in the parameter node "Limiting value X" a direction-dependent setting is made for how the limiting value responds when the set limiting value is exceeded or undershot. If, for example, "undersh. LV=ON, exceed GW+Hyst.=OFF" is selected, the limiting value object is then set to "1" if the limiting value is undershot, and the limiting value object will first be set to "0" when the limiting value plus hysteresis is exceeded.

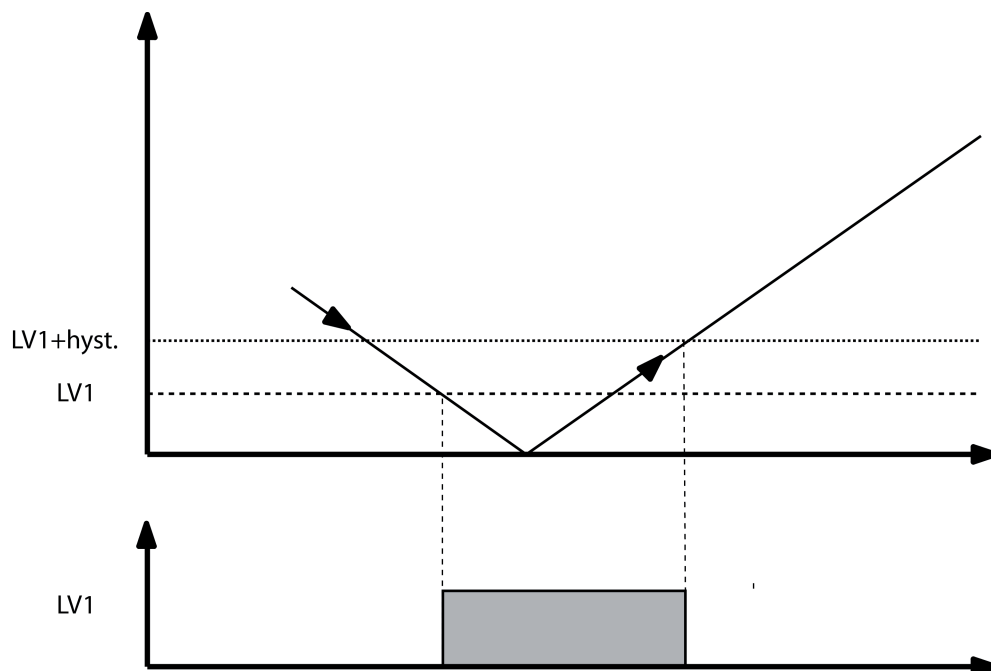

Figure 15: Activation of limiting value

If for a cycle, "no telegr.", i.e. no telegram is configured, the cyclical transmission of the limiting value X is also prevented when this function is activated. The cyclical transmission of the limiting value remains interrupted until the opposite state is reached once again.

Example: Undersh. is configured LV=ON, exceed GW+Hyst.=no telegr.

- An ON telegram is sent when the limiting value is undershot. If "Cycl. sending of limiting value X" is parametrized with '10', then this ON telegram is additionally sent every 100 seconds (10s x 10).

- If the limiting value plus hysteresis is undershot, no telegram is transmitted and the cyclical transmission is suppressed, too.
- If the limiting value is undershot again, an ON telegram is transmitted in turn and the cyclical transmission of this ON telegram is reactivated, too.

Specifying limiting values via external objects

If the limiting values are to be adjustable and thus dynamically adaptable while the system is running, then the parameter "External limiting value X" in the parameter node "limiting value X" can be set to "Absolute value via 2-byte object" or "Percentage via 1-byte object". The communication objects "S... Limiting value specification - Absolute value" (2-byte) or "S... Limiting value specification - percentage" (1-byte) can, for instance, be linked to the value transmitter objects of an external push-button.

- i** If the value specification is triggered by a push-button, this push-button should be configured in such a way that it first transmits the configured value after a long button-press (more than 3 seconds) in order to prevent operating errors.

Limiting value specification via teaching function

If the user should have the option to use the current measured value as a new limiting value without knowing the numerical value himself, the parameter "External limiting value X" in the parameter node "Limiting value X" can be set to "Store limiting value via switching object (teaching)". Once the object "S... Limiting value specification - Learning" thus receives a telegram with the value "1", the device applies the last measured value as new limiting value. Telegrams with the value "0" are ignored.

- i** If the Teaching function is triggered by a push-button, this push-button should be configured in such a way that it first transmits the value "1" after a long button-press (more than 3 seconds) in order to prevent operating errors.

Setting limiting value specification via external objects or by means of teaching

Limiting value specification via an external object for the measured values "CO₂" and "Humidity" is set by means of the parameter "External limiting value X" on parameter node "Limiting value X".

"n limiting values active" is set for the measured value on the parameter page "CO₂ measurement" or "humidity measurement". There is a maximum of four ($n = 1..4$) limiting values available for the CO₂ measured value, and a maximum of two ($n = 1..2$) for the humidity measured value.

- In the input field "External limiting value X", select from the list whether the limiting value specification should be set by "Absolute value via 2-byte object", by "Percentage via 1-byte object" or by "Teaching".

- i** The set value overwrites the limiting value specification via parametrization until it is overwritten by another external value.
- i** The externally predefined value is overwritten by the value configured in the ETS during an ETS programming operation.

Switch-on and switch-off delay of the limiting values

All limiting values of the device can be given switch-on and switch-off delays. It should be noted here that not only is the transmission affected on change of this delay, but the cyclical transmission of the limiting value object, too.

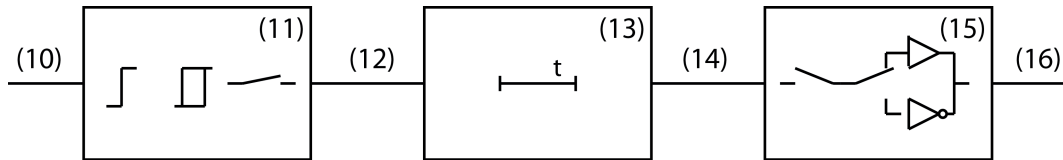

Figure 16: Block diagram for switch-on and switch-off delay

- (10) Measured value
- (11) Limiting value and hysteresis processing
- (12) Internal limiting value
- (13) ON delay and OFF delay
- (14) Delayed, internal limiting value
- (15) Processing of cyclic sending, sending when change, activation of limiting value
- (16) Limiting value object

When the value of an internal limiting value (12) changes from "0" to "1", the parameter value of the switch-on delay is evaluated. When the value of an internal limiting value changes from "1" to "0", the parameter value of the switch-off delay is evaluated. If "no delay" is set, then the value of the delayed internal limiting value immediately takes the value of the internal limiting value. When a delay time is set, a timer with the delay time (13) is loaded and started. Only when it expires is the value of the internal limiting value accepted as the value for the delayed internal limiting value (14) and the limiting value sent in accordance with the parameterisation. The cyclic sending is also affected by this delay. If the internal limiting value changes before the timer expires, then it is stopped and the limiting value remains unchanged. Consequently, no limiting value telegram, triggered by the parameter "Transmission on change of the limiting value object", is transmitted either.

Setting the switch-on delay

A switch-on delay can be set for all limiting values by means of the parameter "Switch-on delay internal limiting value object".

"n limiting values active" is set for the measured value on the parameter page "CO2 measurement" or "humidity measurement".

- In the parameter ""Switch-on delay for internal limiting value object", select the appropriate value from the list.
The switch-on delay is set.

Setting the switch-off delay

An internal switch-off delay can be set for all limiting values by means of the parameter "Switch-off delay for internal limiting value object".

"n limiting values active" is set for the measured value on the parameter page "CO2 measurement" or "humidity measurement".

- In the parameter "Switch-off delay for internal limiting value object", select the appropriate value from the list.
The switch-off delay is set.

Setting sending of a limiting value when there is a change

The transmission property of the limiting values can be influenced by means of the parameter "Transmission on change of the limiting value object" in the parameter node "Limiting value X".

"n limiting values active" is set for the measured value on the parameter page "CO2 measurement" or "humidity measurement". There is a maximum of four ($n = 1 \dots 4$) limiting values available for the CO₂ measured value, and a maximum of two ($n = 1 \dots 2$) for the humidity measured value.

- Set the parameter "Transmission on change of the limiting value object" to "Yes".
The value is transmitted on a change of state from "0" to "1" or from "1" to "0".
- ❗ The object value is sent again if the limiting value even occurs again, even if the reversed event is parametrized to "No telegr."

Cyclic sending of the limiting values

All limiting value objects of the sensors can transmit their state cyclically to the bus.

- ❗ Telegrams of limiting value objects generated by the automatic transmission ("Transmission on change of the limiting value object") do not influence the cycle time for the cyclical transmission of the limiting value objects.
- ❗ If a combination with "no telegr." is set during activation of the limiting value, the corresponding object value is not transmitted on change nor cyclically via the limiting value object.

Setting cyclical transmission of a limit value

"n limiting values active" is set for the measured value on the parameter page "CO2 measurement" or "humidity measurement". There is a maximum of four ($n = 1 \dots 4$) limiting values available for the CO₂ measured value, and a maximum of two ($n = 1 \dots 2$) for the humidity measured value.

- Set the parameter "Cyclical transmission of the limiting value object" to the required cycle time.
The limiting value is sent at the set interval.
- ❗ If the setting is "0", the limiting value is not transmitted cyclically.

4.2.4.4 Room temperature controller

The device can be used for single-room temperature control. Depending on the operating mode, the current temperature setpoint and on the room temperature, command values for heating or cooling control can be sent to the KNX. Usually, these command values are then converted by a suitable KNX actuator, e.g. heating or switching actuators or directly by bus-compatible actuating drives, evaluated and converted to physical variables for air conditioning control.

The room temperature controller is an independent function section of the device. It has its own parameter and object range in the ETS configuration. The room temperature controller is therefore available independent of the function of the inputs, logic gates and humidity and CO₂ sensor.

4.2.4.4.1 Operating modes and operating mode change-over

Introduction

The room temperature controller distinguishes between two different operating modes. The operating modes specify whether you want the controller to use its variable to trigger heating systems ("heating" single operating mode) or cooling systems ("cooling" single operating mode). You can also activate mixed operation, with the controller being capable of changing over between "Heating" and "Cooling" either automatically or, alternatively, controlled by a communication object.

In addition, you can establish two-level control operation to control an additional heating or cooling unit. For two-level feedback control, separate command values will be calculated as a function of the temperature deviation between the setpoint and the actual value and transmitted to the bus for the basic and additional levels. The parameter "Operating mode" in the "Room temperature control -> Controller general" parameter branch specifies the operating mode and, if necessary, enables the additional level(s).

"Heating" or "cooling" single operating modes

In the single "Heating" or "Cooling" operating modes without any additional level, the controller will always work with one command value and, alternatively, when the additional level is enabled, it will use two command value in the configured operating mode. Depending on the room temperature determined and on the specified setpoint temperatures of the operating modes, the room temperature controller will automatically decide whether heating or cooling energy is required and calculates the command value for the heating or cooling system. The controller indicates whether it is currently heating or cooling by means of the objects "Heating message" or "Cooling message". If it is defined in the configuration that a basic and additional level are used, then the basis for the messages "Heating" and "Cooling" is the state that the basic level is currently in.

"Heating and cooling" mixed operating mode

In the "Heating and cooling" mixed operating mode, the controller is capable of triggering heating and cooling systems. In this connection, you can set the change-over behaviour of the operating modes...

- "Change over between heating and cooling" parameter in the "Room temperature controller -> Controller general -> Setpoints" parameter branch set to "Automatic".
In this case, a heating or cooling mode will be automatically activated, depending on the room temperature determined and on the given temperature basic setpoint, or on the deadband, respectively. If the room temperature is within the preset deadband neither heating nor cooling will take place (both command values = "0"). If the room temperature is higher than the cooling temperature setpoint cooling will take place. If the room temperature is lower than the cooling temperature setpoint heating will take place.
When the heating/cooling operating mode is changed over automatically, the information can be actively sent to the bus via the object "Heating/cooling change-over" to indicate whether the controller is working in the heating mode ("1" telegram) or in the cooling mode ("0" telegram). In this connection, the "Automatic heating/cooling change-over transmission" parameter specifies when an operating mode change-over will be transmitted...
Setting "On changing the operating mode": in this case, a telegram will be transmitted solely on change-over from heating to cooling (object value = "0") or from cooling to heating (object value = "1"), respectively.
- Setting "On changing the output command value": with this setting, the current operating mode will be transmitted whenever there is a modification of the output command value. If the variable = "0" the mode which was active last will be transmitted. If the room temperature determined is within the deadband, the operating mode activated last will be retained in the object value until a change-over to the other operating mode takes place, if necessary. In addition, the object value can be output in cycles when automatic switch-over is being made.
The "Cyclical transmission heating/cooling change-over" parameter enables cyclic transmission (factor > "0" setting) and specifies the cycle time.
With an automatic operating mode change-over, it should be noted that under certain circumstances there will be continuous change-over between heating and cooling if the deadband is too small. For this reason, you should, if possible, not set the deadband (temperature difference between the setpoint temperatures for the comfort heating and cooling modes) below the default value (2 K).

- "Change-over between heating and cooling" parameter in the "Room temperature controller -> Controller general -> Setpoints" parameter branch set to "Via object".
In this case, the operating mode is controlled via the object "Heating/cooling change-over", irrespective of the deadband. This type of change-over can, for example, become necessary if both heating and cooling should be carried out through a one-pipe system (heating and cooling system). For this, the temperature of the medium in the single-pipe system must be changed via the system control. Afterwards the heating/cooling operating mode is set via the object (often the single-pipe system uses cold water for cooling during the summer, hot water for heating during the winter).
The "Heating/cooling change-over" object has the following polarities: "1": heating; "0" cooling. After a reset, the object value will be "0", and the "Heating/cooling operating mode change-over after reset" set in the ETS will be activated. You can use the "Heating/cooling operating mode after reset" parameter to set which mode you want to activate after a reset. For the "Heating" or "Cooling" settings, the controller will activate the configured heating/cooling operating mode immediately after the initialisation phase. In case of parameterisation "Operating mode before reset" the operating mode which was selected before the reset will be activated.
If a change-over is made through the object the operating mode will first be changed into the one specified to be activated after a reset. A change-over to the other operating mode will only take place after the device receives an object update, if necessary.
Notes on the setting "Operating mode before reset": frequent changing of the operating mode (e. g. several times a day) during running operation can adversely affect the life of the device as the read-only memory (EEPROM) used has been designed for less frequent write access events only.

- i** Temperature setpoints can be preset for each operating mode in the ETS as part of first configuration. It is possible to configure the setpoints for the "Comfort", "Standby" and "Night" modes directly (absolute setpoint presetting) or relatively (derivation from basic setpoint). With absolute setpoint presetting there is no basic setpoint and also no deadband in the mixed operating mode "Heating and cooling" (if necessary also with additional level). Consequently the room temperature controller cannot control the switch-over of the operating mode automatically, which is why in this configuration the setting for the parameter "Switch-over between heating and cooling" is fixed in the ETS to "Via object".

4.2.4.4.2 Control algorithms and calculation of command values

Introduction

To facilitate convenient temperature control in living or business spaces a specific control algorithm which controls the installed heating or cooling systems is required. Taking account of the preset temperature setpoints and the actual room temperature, the controller thus determines command values which trigger the heating or the cooling system. The control system (control circuit) consists of a room temperature controller, an actuator or switching actuator (when ETD electrothermal drives are used), the actual heating or cooling element (e. g. radiator or cooling ceiling) and of the room. This results in a controlled system Regler Regelstrecke (T-id=964872587 L-id=1014951692 Link auf Ressource).

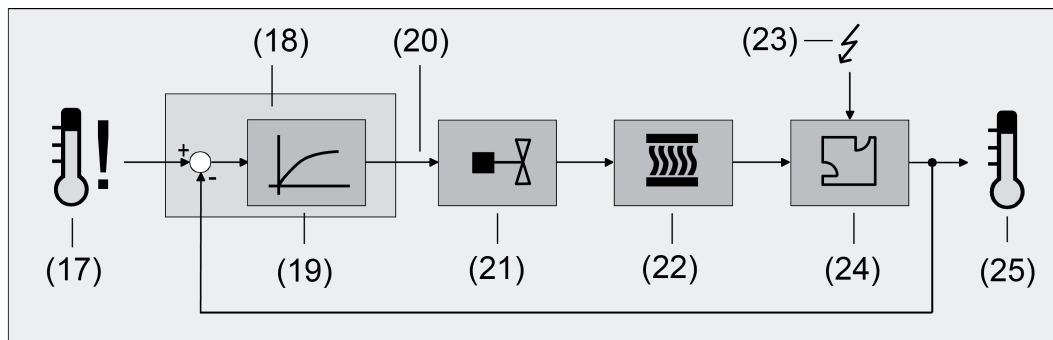

Figure 17: Controlled system of single-room temperature control

- (17) Setpoint temperature specification
- (18) Room temperature controller
- (19) Control algorithm
- (20) Command value
- (21) Valve control (actuating drive, ETD, heating actuator, ...)
- (22) Heat / cold exchanger (radiator, cooling ceiling, FanCoil, ...)
- (23) Fault variable (sunlight penetration, outdoor temperature, illumination systems, ...)
- (24) Room
- (25) Actual temperature (room temperature)

The controller measures the actual temperature (25) and compares it with the given setpoint temperature (17). With the aid of the selected control algorithm (19), the command value (20) is then calculated from the difference between the actual and the setpoint temperature. The command value controls valves or fans for heating or cooling systems (21), meaning that heating or cooling energy in the heat or cold exchangers (22) is passed into the room (24). Regular readjustment of the command value means that the controller is able to compensate for setpoint / actual temperature differences caused by external influences (23) in the control circuit. In addition, the flow temperature of the heating or cooling circuit influences the control system which necessitates adaptations of the variable.

The room temperature controller facilitates either proportional/integral (PI) feedback control as a continuously working or switching option, or, alternatively, switching 2-point feedback control. In some practical cases, it can become necessary to use more than one control algorithm. For example, in bigger systems using floor heating, one control circuit which solely triggers the floor heating can be used to keep the latter at a constant temperature. The radiators on the wall, and possibly even in a side area of the room, will be controlled separately by an additional level with its own control algorithm. In such cases, distinction must be made between the different types of control, as floor heating systems, in most cases, require control parameters which are different to those of radiators on the wall, for example. It is possible to configure up to four independent control algorithms in two-level heating and cooling operation.

It is possible to configure "Heating", "Cooling" or alternatively the mixed mode "Heating and Cooling" as the operating mode. Using the additional stages is also possible. In this connection, you can set different control algorithms for the heating and/or cooling system. Thus, you can use up to four separate algorithms for two-stage heating or cooling operation.

The command values calculated by the control algorithm are output via the "Heating command value" or "Cooling command value" communication objects. Depending on the control algorithm selected for the heating and/or cooling mode, the format of the command value objects is, among other things, also specified. 1-bit or 1-byte actuating objects can be created in this way Regler Regelstrecke (T-id=964872587 L-id=1014951692 [Link auf Ressource](#)). The control algorithm is specified by the parameters "Type of heating control" or "Type of cooling control" in the "Room temperature control -> Controller general" parameter branch and, if necessary, also with a distinction of the basic and additional stages.

Continuous PI control

PI control is an algorithm which consists of a proportional part and an integral part. Through the combination of these control properties, you can obtain room temperature control as quickly and precisely as possible without or only with low deviations.

When you use this algorithm, the room temperature controller will calculate a new continuous command value in cycles of 30 seconds and send it to the bus via a 1-byte value object if the calculated command value has changed by a specified percentage. You can use the "Automatic transmission on change by..." parameter in the "Room temperature controller -> Command value and status output" parameter branch to set the change interval in percent.

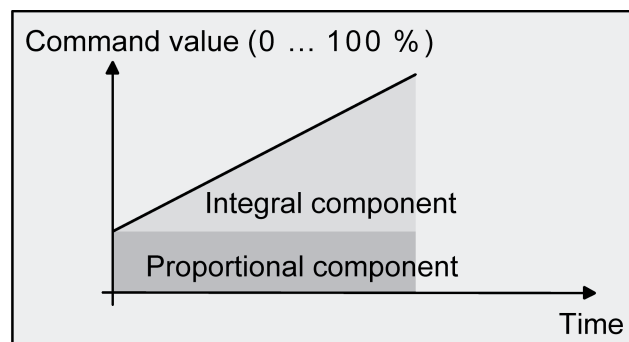

Figure 18: Continuous PI control

An additional heating or cooling level as PI control works in the same way as the PI control of the basic level, with the exception that the setpoint will shift, taking account of the configured level width.

Switching PI control

With this type of feedback control, the room temperature will also be kept constant by the PI control algorithm. Taking the mean value for a given time, the same behaviour of the control system will result as you would obtain with a continuous controller. The difference compared with continuous feedback control is only the way how the command value is output. The command value calculated by the algorithm in cycles of every 30 seconds is internally converted into a pulse-width-modulated (PWM) command value signal and sent to the bus via a 1-bit switching object after the cycle time has elapsed. The mean value of the command value signal resulting from this modulation, taking into account the adjustable cycle time (parameter

"Cycle time of the switching command value..." in the parameter branch "Room temperature control → command value and status output") is a gauge for the averaged valve position of the control valve and thus a reference for the set room temperature.

A shift of the mean value, and thus a change in the heating capacity, can be obtained by changing the duty factor of the switch-on and switch-off pulses of the command value signal. The duty factor will be adapted by the controller only at the end of a time period, depending on the command value calculated. This applies to any change of the command value, regardless of what the ratio is by which the command value changes (the "Automatic transmission on change by..." and "Cycle time for automatic transmission..." parameters will have no function in this case).

Each command value calculated last during an active time period will be converted. Even after you have changed the setpoint temperature, for example, by switching over the operating mode, the command value will still be adapted after the end of an active cycle time. The diagram below shows the command value switching signal output according to the internally calculated command value (first of all, a command value of 30 %, then of 50 %, with the command value output not being inverted).

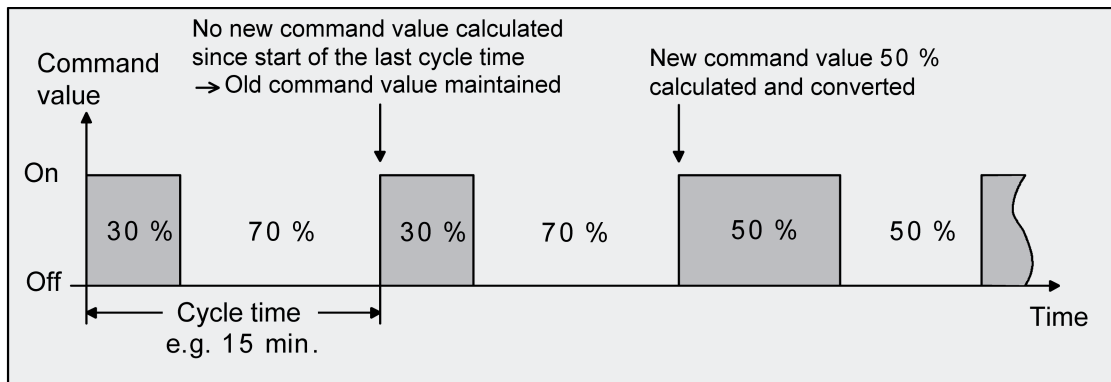

Figure 19: Switching PI control

For a command value of 0 % (permanently off) or of 100 % (permanently on), a command value telegram corresponding to the command value ("0" or "1") will always be sent after a cycle time has elapsed.

For switching PI control, the controller will always use continuous command values for internal calculation. Such continuous values can additionally be sent to the bus via a separate 1-byte value object, for example, as status information for visualisation purposes (if necessary, also separately for the additional levels). The status value objects will be updated at the same time as the command value is output and will only take place after the configured cycle time has elapsed. The parameters "automatic transmission on change by..." and "Cycle time for automatic transmission..." parameters will have no function in this case. An additional heating or cooling level as switching PI control works in the same way as the PI control of the basic stage, with the exception that the setpoint will shift, taking account of the configured level width. All PWM control options will use the same cycle time.

Cycle time:

The pulse-width-modulated command values are mainly used for activating electrothermal drives (ETD). In this connection, the room temperature controller sends the switching command values telegrams to a switching actuator equipped with semiconductor switching elements which the drives are connected to (e.g. heating actuator or room actuator). By setting the cycle time of the PWM signal on the controller, you can adapt the feedback control to the drives used. The cycle time sets the switching frequency of the PWM signal and allows adaptation to the adjusting cycle times (the adjusting time it takes the drive to bring the valve from its completely closed to its completely opened position) of the actuators used. In addition to the adjusting cycle

time, take account of the dead time (the time in which the actuators do not show any response when being switched or off). If different actuators with different adjusting cycle times are used, take account of the longest of the times. Always note the information given by the manufacturers of the actuators.

During cycle time configuration, a distinction can always be made between two cases...

Case 1: Cycle time $> 2 \times$ adjusting cycle time of the electrothermal drives used (ETD)

In this case, the switch-on or switch-off times of the PWM signal are long enough for the actuators to have sufficient time to fully open or fully close within a given time period.

Advantages:

The desired mean value for the command value and thus for the required room temperature will be set relatively precisely, even for several actuators triggered at the same time.

Disadvantages:

It should be noted, that, due to the full valve lift to be continuously 'swept', the life expectancy of the actuators can diminish. For very long cycle times (> 15 minutes) with less sluggishness in the system, the heat emission into the room, for example, in the vicinity of the radiators, can possibly be non-uniform and be found disturbing.

- i** This setting is recommended for sluggish heating systems (such as underfloor heating).
- i** Even for a bigger number of triggered actuators, maybe of different types, this setting can be recommended to be able to obtain a better mean value of the adjusting travels of the valves.

Case 2: Cycle time $<$ adjusting cycle time of the electrothermal drives used (ETD)

In this case, the switch-on or switch-off times of the PWM signal are too short for the actuators to have enough time to fully open or fully close within a given period.

Advantages:

This setting ensures continuous water flow through the radiators, thus facilitating uniform heat emission into the room.

If only one actuator is triggered the controller can continuously adapt the command value to compensate the mean value shift caused by the short cycle time, thus setting the desired room temperature.

Disadvantages:

If more than one drive is triggered at the same time the desired mean value will become the command value, which will result in a very poor adjustment of the required room temperature, or in adjustment of the latter with major deviations, respectively.

The continuous flow of water through the valve, and thus the continuous heating of the drives causes changes to the dead times of the drives during the opening and closing phase. The short cycle time and the dead times means that the required variable (mean value) is only set with a possibly large deviation. For the room temperature to be regulated constantly after a set time, the controller must continually adjust the command value to compensate for the mean value shift caused by the short cycle time. Usually, the control algorithm implemented in the controller (PI control) ensures that control deviations are compensated.

- i** This setting is recommended for quick-reaction heating systems (such as surface radiators).

Switching 2-point feedback control

The 2-point control represents a very simple temperature control. For this type of feedback control, two hysteresis temperature values are set. The actuators are triggered by the controller via switch-on and switch-off command value commands (1-bit type). A continuous command

value is not calculated for this type of control.

The room temperature is also evaluated by this type of control in cycles every 30 seconds. Thus the command values change, if required, only at these times. The disadvantage of a continuously varying temperature as a result of this feedback control option is in contrast with the advantage of this very simple 2-point room temperature control. For this reason, quick-reaction heating or cooling systems should not be triggered by a 2-point feedback control system, for this can lead to very high overshooting of the temperature, thus resulting in loss of comfort. When presetting the hysteresis limiting values, you should distinguish between the operating modes.

"Heating" or "cooling" single operating modes:

In heating mode, the controller will turn on the heating when the room temperature has fallen below a preset limit. In heating mode, the feedback control will only turn off the heating if the preset temperature limit has been exceeded.

In cooling mode, the controller will turn on the cooling system when the room temperature has exceeded a preset limit. The control system will only turn off the cooling system if the temperature has fallen below a preset limit. In this connection, variable "1" or "0" will be output, depending on the switching status, if the temperature exceeds or falls below the hysteresis limits.

The hysteresis limits of both operating modes can be configured in the ETS.

The following two images each show a 2-point feedback control for the individual operating modes "Heating" (Figure 20) or "Cooling" (Figure 20). The images take two temperature setpoints, one-stage heating or cooling and non-inverted command value output.

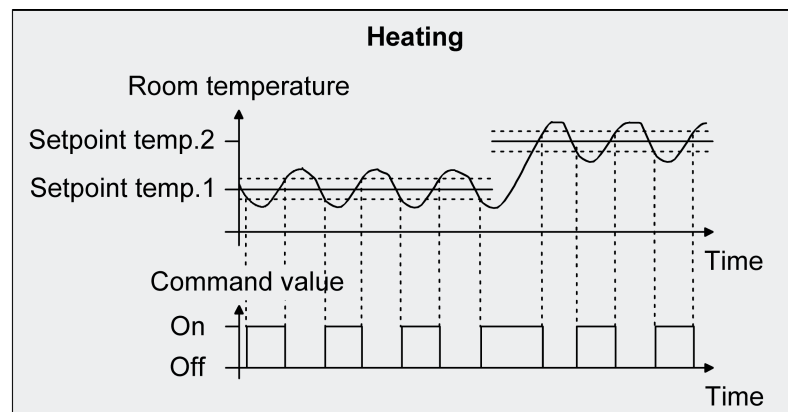

Figure 20: 2-point feedback control for the single "Heating" operating mode

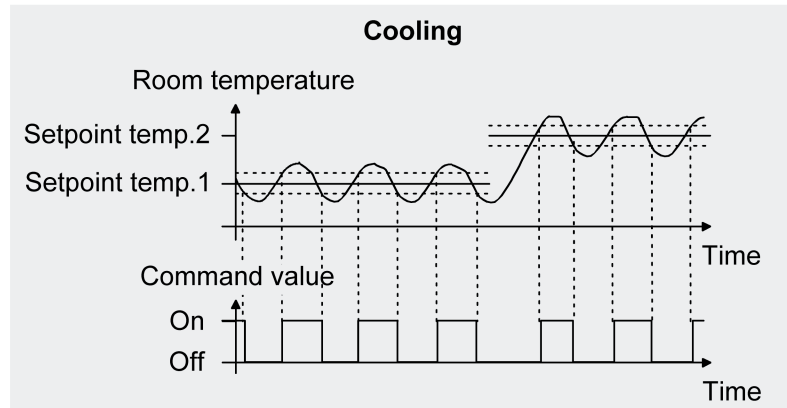

Figure 21: 2-point feedback control for the single "Cooling" operating mode

An additional 2-point feedback control heating or cooling level works exactly the same as the 2-point feedback control of the basic level. The difference is that the setpoint and the hysteresis values will shift by taking into account the configured level offset.

"Heating and cooling" mixed operating mode:

In mixed operation, a distinction is made whether the change-over between heating and cooling is to be effected automatically or in a controlled way through the object.

- With automatic operating mode change-over, in the heating mode the controller will turn on the heating when the room temperature has fallen below the preset hysteresis limit. In this case, as soon as the room temperature exceeds the setpoint of the current operating mode, the feedback control will turn off the heating in the heating mode. Similarly, in cooling mode, the controller will turn on the cooling system when the room temperature has exceeded the preset hysteresis limit. As soon as the room temperature falls below the setpoint of the current operating mode, the feedback control will turn off the cooling system in the cooling mode. Thus, in mixed operation, there is no upper hysteresis limit for heating or no lower one for cooling, respectively, for these values would be in the deadband. Within the deadband, neither heating nor cooling will take place.
 - With operating mode change-over via the object, in the heating mode, the controller will turn on the heating when the room temperature has fallen below the preset hysteresis limit. The feedback control will only turn off the heating in the heating mode if the preset upper hysteresis limit has been exceeded. Similarly, in cooling mode, the controller will turn on the cooling system when the room temperature has exceeded the preset hysteresis limit. The feedback control will only turn off the cooling system in the cooling mode if the temperature has fallen below the preset lower hysteresis limit. As with the individual modes of heating or cooling, there are two hysteresis limits per operating mode. Although there is a deadband for the calculation of the temperature setpoints for cooling, it has no influence of the calculation of the two-point control value, as the operating mode is switched over "manually" through the corresponding object. Within the hysteresis spans, it thus will be possible to request heating or cooling energy for temperature values that are located within the deadband.
- i** Also with an automatic operating mode switch, an upper hysteresis limit for heating and a lower hysteresis limit for cooling can be configured in the ETS for 2-point feedback control, although they have no function.

The following two images show 2-point feedback control for the mixed operating mode "Heating and cooling", distinguishing between heating mode (Figure 20) and cooling mode (Figure 20). The images take two temperature setpoints, a non-inverted command value output and an automatic operating mode change-over. When the operating mode is changed-over via the object, an upper hysteresis for heating and a lower hysteresis for cooling and be configured.

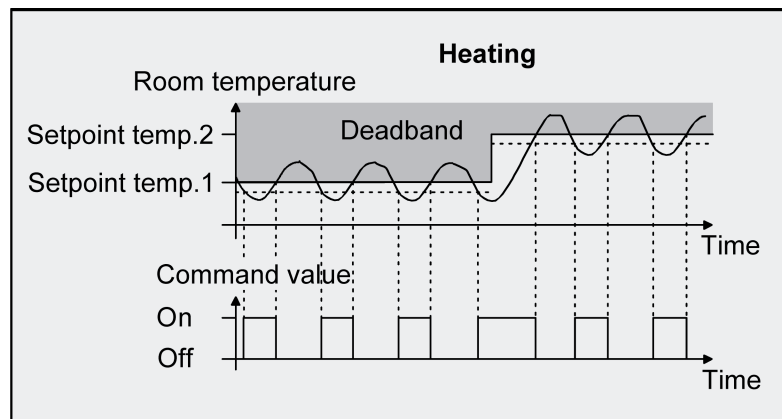

Figure 22: 2-point feedback control for mixed "Heating and cooling" mode with active heating mode.

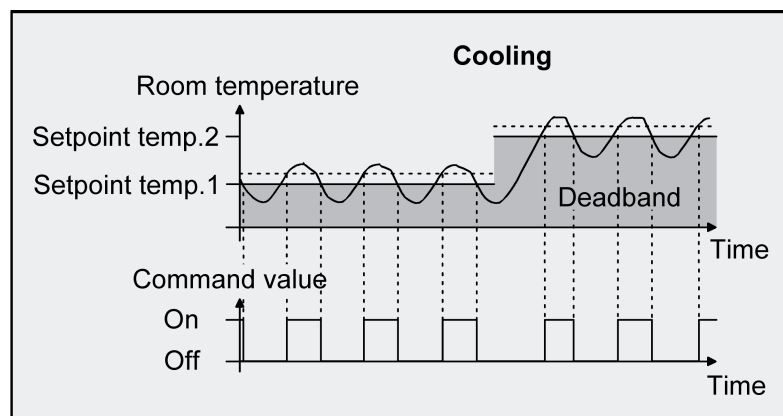

Figure 23: 2-point feedback control for mixed "Heating and cooling" mode with active cooling operation.

Depending on the switching state, the command value "1" or "0" will be output if the values exceed or remain under the hysteresis limits or the setpoints.

- i It has to be pointed out that the message objects for heating and cooling will already become active as soon as the temperature falls short of the temperature setpoint of the active operating mode in case of heating or exceeds the temperature setpoint in case of cooling. In this case the hysteresis is not being considered.

An additional 2-point feedback control heating or cooling level works exactly the same as the 2-point feedback control of the basic level. The difference is that the setpoint and the hysteresis values will shift by taking into account the configured level offset.

4.2.4.4.3 Adapting the control algorithms

Adapting the PI control

There are several systems available, which may heat or cool a room. One option is to uniformly heat or cool the surroundings via heat transfer media (preferably water or oil) in connection with room air convection. Such systems are used, for example, with wall mounted heaters, underfloor heating or cooling ceilings.

Alternatively or additionally forced air systems may heat or cool rooms. In most cases such systems are electrical forced hot air systems, forced cool air systems or refrigerating compressors with fan. Due to the direct heating of the room air such heating and cooling systems work quite swiftly.

The control parameters need to be adjusted so that the PI control algorithm may efficiently control all common heating and cooling systems thus making the room temperature control work as fast as possible and without deviation. Certain factors can be adjusted with a PI control that can influence the control behaviour quite significantly at times. For this reason, the room temperature controller can be set to predefined 'experience values' for the most common heating and cooling systems. In case the selection of a corresponding heating or cooling system does not yield a satisfactory result with the default values, the adaptation can optionally be optimised using control parameters.

Predefined control parameters for the heating or cooling level and, if applicable, also for the additional levels are adjusted via the "Type of heating" or "Type of cooling" parameters. These fixed values correspond to the practical values of a properly planned and executed air conditioning system and will result in an ideal behaviour of the temperature control. The heating and cooling types shown in the following tables can be specified for heating and cooling operation.

Type of heating	Proportional range (preset)	Reset time (preset)	Recommended PI control type	Recommended PWM cycle time
Heat water heating	5 Kelvin	150 minutes	Continuous / PWM	15 min.
Underfloor heating	5 Kelvin	240 minutes	PWM	15-20 min.
Electrical heating	4 Kelvin	100 minutes	PWM	10-15 min.
Fan coil unit	4 Kelvin	90 minutes	Continuous	---
Split unit (split climate control unit)	4 Kelvin	90 minutes	PWM	10-15 min.

Table 2: Predefined control parameters and recommend control types for heating systems

Cooling type	Proportional range (preset)	Reset time (preset)	Recommended PI control type	Recommended PWM cycle time
Cooling ceiling	5 Kelvin	240 minutes	PWM	15-20 min.
Fan coil unit	4 Kelvin	90 minutes	Continuous	---
Split unit (split climate control unit)	4 Kelvin	90 minutes	PWM	10-15 min.

Table 3: Predefined control parameters and recommend control types for cooling systems

If the "Type of heating" or "Type of cooling" parameters are set to "Via control parameters" it will be possible to adjust the control parameter manually. The feedback control may be considerably influenced by presetting the proportional range for heating or for cooling (P component) and the reset time for heating or for cooling (I component).

- i** Even small adjustments of the control parameters will lead to noticeable different control behaviour.
- i** The adaptation should start with the control parameter setting for the corresponding heating or cooling system according to the fixed values mentioned in tables 2 and 3.

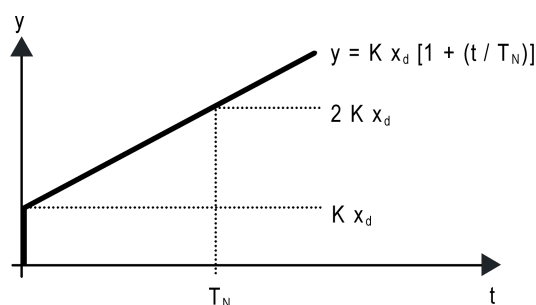

Figure 24: Function of the command value of a PI control

y: Command value
 x_d : Control difference ($x_d = x_{set} - x_{act}$)
 $P = 1/K$: Configurable proportional band
 $K = 1/P$: Gain factor
 T_N : Configurable reset time

PI control algorithm: Command value $y = K x_d [1 + (t / T_N)]$

Deactivation of the reset time (setting = "0") ->

P control algorithm: Command value $y = K x_d$

Parameter setting	Effect
P: Small proportional range	Large overshoot in case of setpoint changes (possibly permanently), quick adjustment to the setpoint
P: Large proportional range	No (or small) overshoot but slow adjustment
T_N : Short reset time	Fast compensation of control deviations (ambient conditions), risk of permanent oscillations
T_N : Long reset time	Slow compensation of control deviations

Table 4: Effects of the settings for the control parameters

Adapting the 2-point feedback control

The 2-point control represents a very simple temperature control. For this type of feedback control, two hysteresis temperature values are set. The upper and lower temperature hysteresis limits can be adjusted via parameters. It has to be considered that...

- A small hysteresis will lead to small temperature variations but to a higher bus load.
- A large hysteresis switches less frequently but will cause uncomfortable temperature variations.

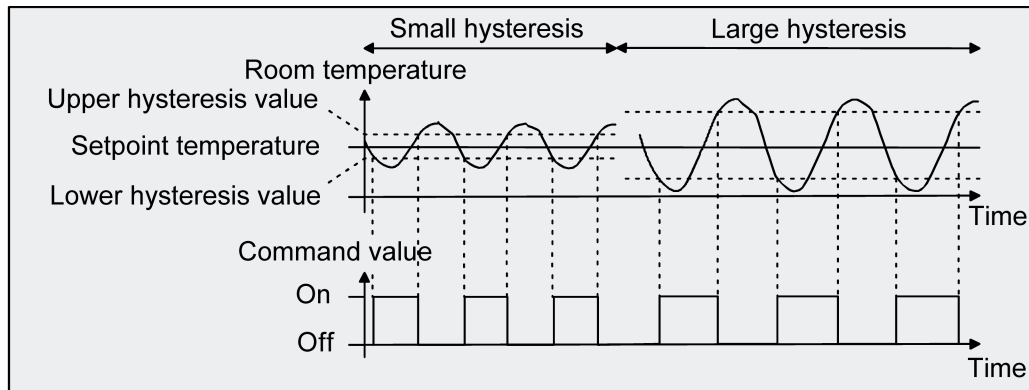

Figure 25: Effects of the hysteresis on the switching behaviour of the command value of 2-point feedback control

4.2.4.4.4 Operating mode switchover

Introduction - The operating modes

The room temperature controller has various operating modes. The selection of these modes will, for example, facilitate the activation of different temperature setpoints, depending on the presence of a person, on the state of the heating or cooling system, on the time of the day, or on the day of the week. The following operating modes can be distinguished...

- Comfort mode
Comfort mode is usually activated if persons are in a room, and the room temperature should, for this reason, be adjusted to an adequately convenient value. The change-over to this operating mode can take place either by pressing a button or with presence control, for example, using a PIR motion detector on the wall or a ceiling mounted detector.
 - Standby mode
If a room is not used during the day because persons are absent, you can activate the Standby mode. Thereby, you can adjust the room temperature on a standby value, thus to save heating or cooling energy, respectively.
 - Night operation
During the night hours or during the absence of persons for a longer time, it mostly makes sense to adjust the room temperature to lower values for heating systems (e.g. in bedrooms). In this case, cooling system can be set to higher temperature values, if air conditioning is not required (e.g. in offices). For this purpose, you can activate the Night mode.
 - Frost/heat protection mode
Frost protection will be required if, for example, the room temperature must not fall below critical values while the window is open. Heat protection can be required where the temperature rises too much in an environment which is always warm, mainly due to external influences. In such cases, you can activate the Frost/heat protection operating mode and prescribe some temperature setpoint of its own for either option, depending on whether "Heating" or "Cooling" has been selected, to prevent freezing or overheating of the room.
 - Comfort extension (temporary Comfort mode)
You can activate the comfort extension from the night or frost/heat protection mode (not triggered by the "Window status" object) and use it to adjust the room temperature to a comfort value for some time if, for example, the room is also 'used' during the night hours. This mode can exclusively be activated by a presence button or also by the presence object, respectively. The comfort extension option will be automatically deactivated after a definable time has elapsed, or by pressing the presence button once more, or by receiving a presence object value = 0, respectively. You cannot retrigger this extension.
- i** You can assign an own temperature setpoint to the "Heating" or "Cooling" operating modes for each operating mode.

Operating mode switchover

The operating modes can be activated or switched over by means of the 1-bit communication object available separately for each operating mode, or alternatively, by means of the KNX objects. In the last case, also through a controller extension.

Change-over of the operating mode using KNX communication objects

A distinction is made whether the operating modes should be changed over via separate 1-bit objects or, alternatively, by the 1-byte KNX objects.

The "Operating mode change-over" parameter in the "Room temperature control -> Controller general" parameter branch specifies the switching method as follows.

- Operating mode change-over "Via switching (4 x 1 bit)"

There is a separate 1-bit change-over object for each operating mode. Each of these objects allows the current operating mode to be switched over or to be set, depending on the priority. Taking account of the priority, a specific hierarchy will result from the operating mode change-over by the objects, a distinction being made between presence detection by the presence button (Figure 26) or the motion detector (Figure 26). In addition, the status of the window in the room can be evaluated using the "Window status" object, meaning that, when the window is open, the controller can switch to Frost/heat protection mode, irrespective of the set operating mode, in order to save energy .

Table 5 also shows the status of the communication objects and the resulting operating mode.

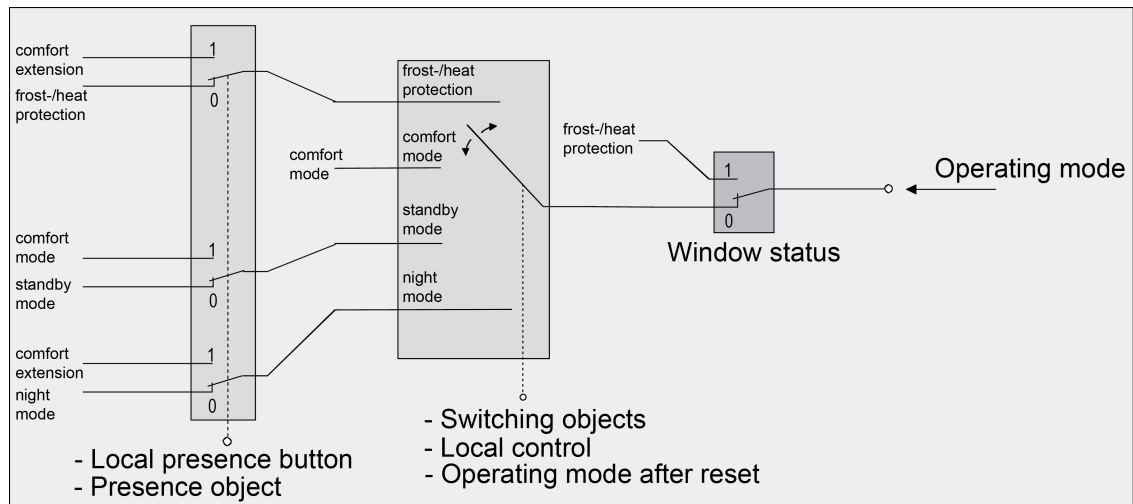

Figure 26: Operating mode change-over through 4 x 1-bit objects with presence button

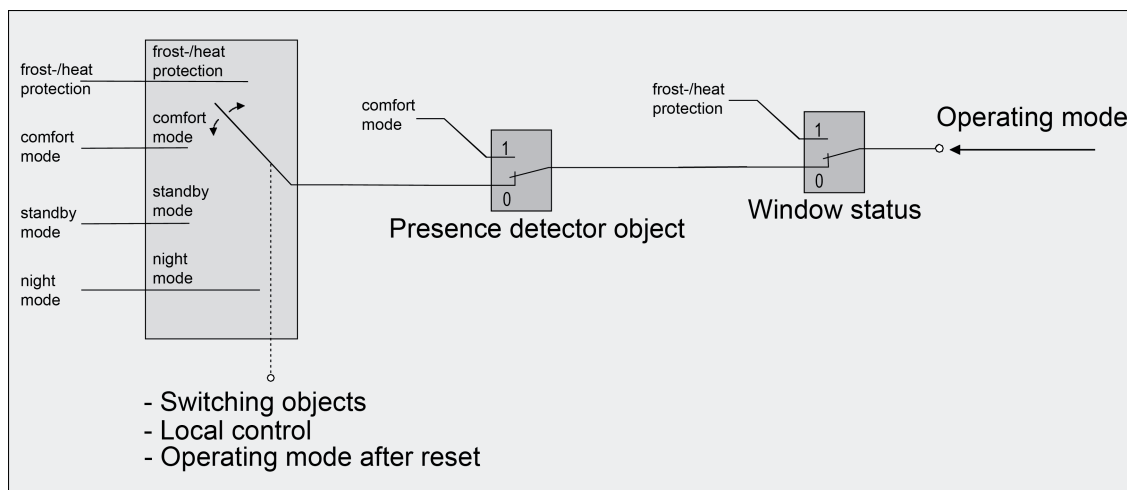

Figure 27: Operating mode change-over through 4 x 1-bit objects with motion detector

Object Frost-/Heat protection	Object Comfort mode	Object Standby mode	Object Night mode	Object Window status	Motion button	Motion detector	Operation mode
1	X	X	X	0	0	-	Frost/heat protection
0	1	X	X	0	0	-	Comfort mode
0	0	1	X	0	0	-	Standby mode
0	0	0	1	0	0	-	Night operation
0	0	0	0	0	0	-	no change / last state
X	X	X	X	1	X	-	Frost/heat protection
1	X	X	X	0	1	-	Comfort extension
0	1	X	X	0	1	-	Comfort mode
0	0	1	X	0	1	-	Comfort mode
0	0	0	1	0	1	-	Comfort extension
0	0	0	0	0	1	-	Comfort mode-/ extension *
1	X	X	X	0	-	0	Frost/heat protection
0	1	X	X	0	-	0	Comfort mode
0	0	1	X	0	-	0	Standby mode
0	0	0	1	0	-	0	Night operation
0	0	0	0	0	-	0	no change / last state
X	X	X	X	1	-	X	Frost/heat protection

X	X	X	X	0	-	1	Comfort mode
---	---	---	---	---	---	---	--------------

Table 5: Status of the communication objects and the resulting operating mode

X: Status irrelevant

-: Not possible

*: Dependent on the last active operating mode.

- i When changing over the operating mode, the objects "Comfort mode", "Standby mode", "Night mode" and "Frost/heat protection" are updated by the controller and can be read out when the appropriate Read flags are set. If the "Transmit" flag has been set for these objects the current values will, in addition, be automatically transmitted to the bus when they are changed. After bus voltage recovery or after initialisation of the controller, the object which corresponds to the selected operating mode will be updated and its value actively transmitted to the bus if the "Transmit" flag has been set.
- i In parameterisation of a presence button: the presence object will be active ("1") for the period of an comfort extension. The presence object will be automatically deleted ("0") if the comfort extension is stopped after the extension time has elapsed, or if the operating mode has been changed by a higher-priority operation through the change-over objects. The controller therefore automatically resets the status of the presence button when an object is received via the operating mode objects.

- Operating mode change-over through "value (1 byte)"

There is a common 1-byte change-over object for all operating modes. During the running time, the operating mode can be changed over through this value object immediately after the receipt of only one telegram. In this connection, the value received will set the operating mode. In addition, a second 1-byte object is available which, by forced control and through higher level, can set an operating mode, irrespective of any other change-over options. According to the KNX specification, both 1-byte objects have been implemented. Taking account of the priority, a specific hierarchy will result from the operating mode change-over by the objects, a distinction being made between presence detection by the presence button (Figure 26) or the motion detector (Figure 26). In addition, the status of the window in the room can be evaluated using the "Window status" object, meaning that, when the window is open, the controller can switch to Frost/heat protection mode, irrespective of the set operating mode, in order to save energy . Table 6 also shows the status of the communication objects and the resulting operating mode.

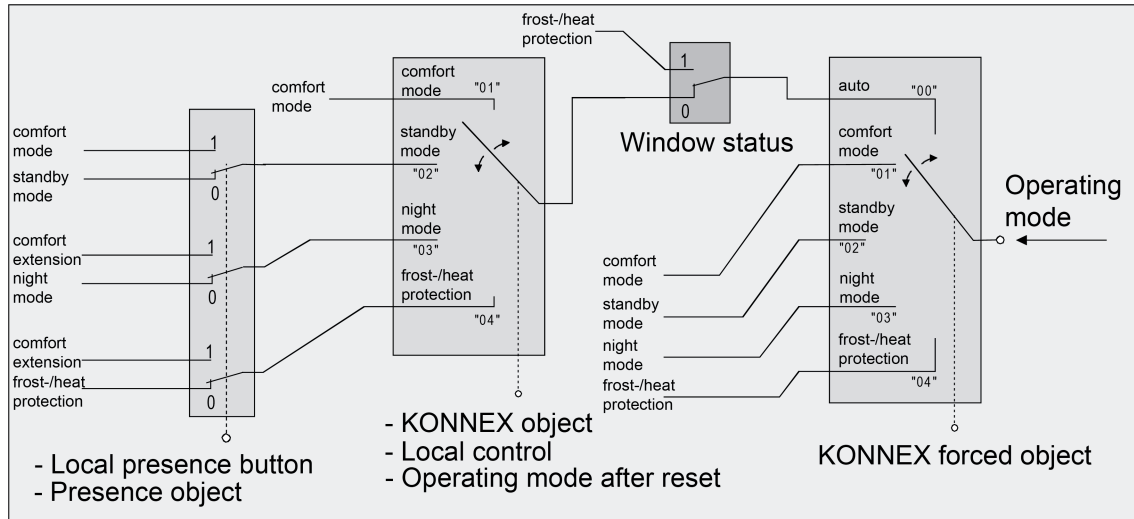

Figure 28: Operating mode change-over through KONNEX object with presence button

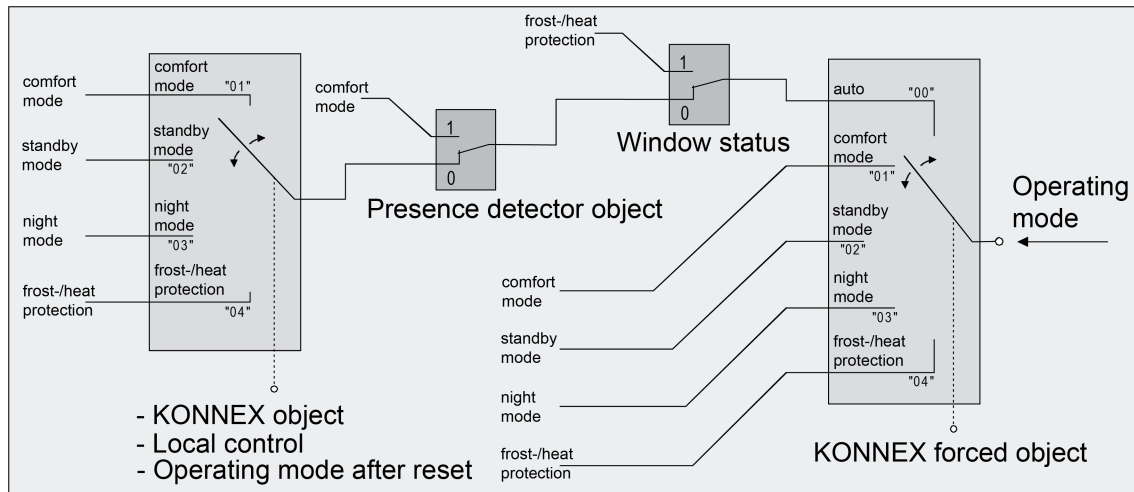

Figure 29: Operating mode change-over through KONNEX object with motion detector

Object Operating mode switch-over	Object Forced object operating mode	Object Window status	Motion button	Motion detector	operating mode
00	00	0	X	0	undefined status, no modification
01	00	0	0	-	Comfort mode
02	00	0	0	-	Standby mode
03	00	0	0	-	Night operation
04	00	0	0	-	Frost/heat protection
01	00	0	1	-	Comfort mode
02	00	0	1	-	Comfort mode

03	00	0	1	-	Comfort extension
04	00	0	1	-	Comfort extension
01	00	0	-	0	Comfort mode
02	00	0	-	0	Standby mode
03	00	0	-	0	Night operation
04	00	0	-	0	Frost/heat protection
X	00	0	-	1	Comfort mode
X	00	1	-	X	Frost/heat protection
X	00	1	X	-	Frost/heat protection
X	01	X	X	X	Comfort mode
X	02	X	X	X	Standby mode
X	03	X	X	X	Night operation
X	04	X	X	X	Frost/heat protection

Table 6: Status of the communication objects and the resulting operating mode

X: Status irrelevant

-: Not possible

- i** When changing over the operating mode, the KNX change-over object is updated by the controller and can be read out if the "Read" flag is set. If the "Transmit" flag has been set for this object the current value will, in addition, be automatically transmitted to the bus when it is changed.
After a device reset, the value corresponding to the set operating mode will be actively transmitted to the bus if the "Transmit" flag has been set.
- i** In parameterisation of a presence button: the presence object will be active ("1") for the period of an active comfort extension. The presence object will be automatically deleted ("0") if the comfort extension is stopped after the extension time has elapsed, or if the operating mode has been changed by a higher-priority operation through the change-over objects or by local control or a forced operating mode is deactivated by the KNX forced object (forced object -> "00"). The controller therefore automatically resets the status of the presence button when an object value is received via the operating mode objects or the forced object is reset.

Additional information on the Presence function / Comfort extension

With presence detection, the room temperature controller can quickly change over to a comfort extension upon push button actuation or go into the Comfort mode when movement by a person in the room is detected. In this connection, the "Presence detection" parameter in the "Room temperature controller -> Controller functionality" parameter node sets whether presence detection should be movement-controlled by a motion detector or manual through presence button actuation.

- Presence detection by the presence button
Presence detection by the presence button is configured under "Controller functionality". Then the "presence object" is enabled, too. In this way, you can actuate the presence button or use a presence object value = "1" to change over to comfort extension when the Night or the Frost/heat protection mode is active (not activated by the "window status" object). The extension will be automatically deactivated as soon as the configured "Length of comfort extension" time has elapsed. If you press the presence button once more, or if the presence object receives a value = "0", you can deactivate the comfort extension earlier. You cannot re-trigger such extension time.
If you have set the length of comfort extension to "0" in the ETS, you cannot activate a comfort extension from the night or frost/heat protection mode. In this case, the operating mode will not be changed, although the presence function has been activated.
If the standby mode is active you can operate the presence button or use a presence object value = "1" to change over to the comfort mode. This will also be the case if you have configured the length of comfort prolongation to "0". The comfort mode will remain active as long as the presence function remains active, or until another operating mode comes into effect.
The presence object or the presence function, respectively, will always be deleted whenever a change-over to a different operating mode takes place, or after a forced operating mode has been deactivated (associated with KNX forced change-over). A presence function activated before a device reset (programming operation, bus voltage failure) is always deleted, along with the object value, after the reset.

- Presence detection by the motion detector
If a motion detector is configured for motion detection, then the controller only evaluates the "Presence object". With this object, it is possible to integrate motion detectors into room temperature control. If a movement is detected ("1" telegram) the controller will change over into the Comfort mode. In this connection, it is irrelevant what has been set by the change-over objects directly on the device. Only a window contact or the KNX forced object are of higher priority.
After the movement delay time has elapsed in the motion detector ("0" telegram), the controller will return to the operating mode which was active before presence detection, or it will compensate the telegrams of the operating mode objects received during presence detection, respectively. During active presence detection, you cannot change-over the operating mode on the room temperature controller.
A presence function activated before a device reset (programming operation, bus voltage failure) is always deleted, along with the object value, after the reset. In this case, the motion detector must transmit a new "1" telegram to the controller to activate the presence function.

Additional information on the window status and the automatic frost protection

The room temperature controller offers various options to change over into the Frost/heat protection mode. In addition to switching-over by means of the corresponding operating mode switch-over object, the frost/heat protection can be activated by a window contact, or alternatively, the frost protection can be activated by an automatic temperature function. With these options, the window contact or the automatic function has higher priority. You can use the "frost/heat protection" parameter in the "room temperature regulator function -> controller general" parameter branch to set the way how such higher-priority switch-over will take place...

- Frost/heat protection switch-over "via window status"
The 1-bit object, "window status" is enabled. A telegram having the value of = "1" (open window) and sent to this object will activate the frost/heat protection mode. If this is the case, the operating mode cannot be deactivated by the switch-over object (except for the KNX forced object). Only a telegram with the value of = "0" (closed window) will reset the window status and deactivate the frost/heat protection mode. After this, the operating mode set before the opening of the window or that mode carried by the bus while the window was open will be activated.
You can optionally parameterise a window status delay. Such delay can make sense if short ventilation of the room by opening the window is not supposed to change the operating mode. You can use the "window status delay" parameter to set this delay time between 1 and 255 minutes. The window status will only be changed and thus the frost/heat protection mode activated after this parameterised time has elapsed. A setting of "0" will effect the immediate activation of the frost/heat protection mode when the window is open. The window status will be in effect in the heating and in the cooling mode. The value of the object "window status" is deleted after a reset.

 - Frost protection mode switch-over by "automatic frost protection"
For this setting, automatic switch-over to the frost protection mode can be made at times, depending on the room temperature determined. If there are no window contacts, this setting can prevent unnecessary heating up of the room when windows or external doors are open. In connection with this function, a quick temperature drop can be detected by measuring the actual temperature every minute as, for example, is the case when a window is open. If the temperature decrease detected reaches a parameterised value the room temperature regulator will automatically switch over to the frost protection mode. You can use the "automatic frost protection temperature drop" parameter to set the maximum temperature drop in K/min for switching over to the frost protection mode. After the time preset by the "frost protection period in automatic mode" parameter has elapsed, the regulator will return into the mode which was set before frost protection. Re-triggering will not be possible.
If a new operating mode was received during the frost protection when switching over by 1-byte via the KNX switch-over object, this tracked mode is set according to the automatic frost protection. If a switch-over was made by 4 x 1 bit during frost protection via the change-over object, then this newly received mode will be discarded after the end of the automatic frost protection. The controller then remains in frost protection. Only after that can the operating mode be switched over by the objects. The KNX override object has a higher priority than the automatic frost protection mode and can interrupt the latter.
- i** The automatic frost protection mode only acts on heating for temperatures below the set value temperature of the operating mode selected. Thus, no automatic switch-over to frost protection can take place at room temperatures in the dead band or in the active cooling mode if the "heating and cooling" mode is on. Automatic heat protection activation is not intended with this parameterization.
 - i** Frequent draughts in a room can cause unintentional activation/deactivation of frost protection when the automatic frost protection mode is active, and if the parameterized temperature decrease is not low enough. Therefore switching into the frost/heat protection mode by window contacts should generally be preferred to the automatic option.

Additional information on the operating mode after a reset

In the ETS, it is possible to use the "Operating mode after reset" parameter in the "Room temperature controller / Controller general" parameter node to set which operating mode should be activated after bus voltage recovery or re-programming by the ETS. The following settings are possible...

- "Comfort operation" -> The comfort mode will be activated after the initialisation phase.
- "Standby mode" -> The standby mode will be activated after the initialisation phase.
- "Night operation" -> The night mode will be activated after the initialisation phase.
- "Frost/heat protection operation" -> The frost/heat protection mode will be activated after the initialisation phase.
- "Restore operation mode before reset" -> The mode set before a reset according to the operating mode object will be restored after the initializing phase of the device. Operating modes set by a function with a higher priority before the reset (Forced, Window status, Presence status) are not effected.

The operating mode objects will be updated after a reset.

- i** Note on the "restore operation mode before reset" setting:
Frequent changing of the operating mode (e. g. several times a day) during running operation can adversely affect the life of the device as the read-only memory (EEPROM) used has been designed for less frequent write access events only.

4.2.4.4.5 Temperature setpoints

Setpoint temperature presetting

Temperature setpoints can be preset for each operating mode in the ETS as part of first configuration. It is possible to configure the setpoints for the "Comfort", "Standby" and "Night" modes directly (absolute setpoint presetting) or relatively (derivation from basic setpoint). The setpoint temperatures can later be adapted during regular operation if desired, controlled by the KNX communication objects.

- i** The "Frost/heat protection" operating mode allows the separate configuration of two temperature setpoints for heating (frost protection) and cooling (heat protection) solely in the ETS. These temperature values cannot be changed later during controller operation.

The "Setpoint presetting" parameter on the parameter page "Room temperature control -> Controller general -> Setpoints" defines the way the setpoint temperature is preset...

- "Relative (setpoint temperatures from basic setpoint)" setting:
When presetting the set-temperatures for comfort, standby and night mode, attention has to be paid to the fact that all setpoints depend on each other as all values are derived from the basic temperature (basic setpoint). The "Basic temperature after reset" parameter in the "Room temperature control -> Controller general -> Setpoints" parameter page determines the basic setpoint, which is loaded when the device is programmed via the ETS. Taking into account the "Reduce / increase the setpoint temperature in standby mode" or "Reduce / increase the setpoint temperature in night mode" parameters the temperature setpoints for the standby and night mode are derived from this value depending on the heating or cooling operating mode. The deadband will be additionally considered for the "Heating and cooling" operating mode.

The 2-byte object "Basic setpoint" provides the option of changing the basic temperature, and thus all the dependent setpoint temperatures during device operation. A change via the object must always be enabled in the ETS by configuring the parameter "Change the basic temperature setpoint via bus" to "Approve". If the basic setpoint adjustment via the bus is disabled, the "Basic setpoint" object will be hidden. The controller rounds the temperature values received via the object to the configured interval of the basic setpoint shift (0.1 K or 0.5 K).

- "Absolute (independent setpoint temperatures)" setting
The setpoint temperatures for comfort, standby and night mode are independent of each other. Depending on the operating mode and heating/cooling mode, various temperature values can be specified in the ETS within the range +7.0 °C to +40.0 °C. The ETS plug-in does not validate the temperature values. It is thus possible, for example, to select smaller setpoint temperatures for cooling mode than for heating mode, or to specify lower temperatures for comfort mode than for standby mode.

After commissioning using the ETS the setpoint temperatures can be changed via the bus by means of temperature telegrams. This can be done using the communication object "Setpoint active operating mode". When the controller receives a telegram via this object, it immediately sets the received temperature as the new setpoint of the active operating mode, and operates from then on with this setpoint. In this manner it is possible to adapt the setpoint temperatures of all operating modes separately for heating and cooling mode. The frost or heat protection temperature programmed in using the ETS cannot be changed in this manner.

- i** With absolute setpoint presetting there is no basic setpoint and also no deadband in the mixed operating mode "Heating and cooling" (if necessary also with additional level). Consequently the room temperature controller cannot control the switch-over of the operating mode automatically, which is why in this configuration the setting for the parameter "Switch-over between heating and cooling" is fixed in the ETS to "Via object". Furthermore, setpoint shifting does not exist for absolute setpoint presetting.

The temperature setpoints programmed in the room temperature controller by the ETS during commissioning can be changed via communication objects. In the ETS the parameter

"Overwrite setpoints in device during ETS programming operation?" can be used on the parameter page "Room temperature control -> Controller general -> Setpoints" to define whether the setpoints present in the device, which may have been changed subsequently, are overwritten during an ETS programming operation and thus replaced again by the values parameterised in the ETS. If this parameter is on "Yes", then the temperature setpoints are deleted in the device during a programming operation and replaced by the values of the ETS. If this parameter is configured to "No", then setpoints present in the device remain unchanged. The setpoint temperatures entered in the ETS then have no significance.

- i** During initial commissioning of the device the parameter "Overwrite setpoints in device during ETS programming operation?" must be set to "Yes" in order to perform valid initialisation of the memory slots in the device. The setting "Yes" is also necessary if essential controller properties (operating mode, setpoint presetting, etc.) are being changed in the ETS using new parameter configurations!

Setpoint temperatures for relative setpoint presetting

Depending on the operating mode, different cases should be distinguished when specifying the relative setpoint temperature, which then have an impact on the temperature derivation from the basic setpoint.

Setpoints for operating mode "Heating"

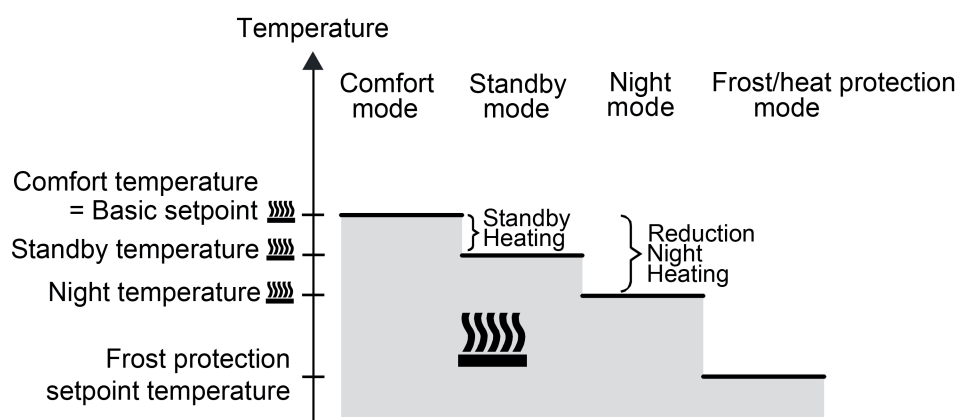

Figure 30: Setpoint temperatures in the operating mode "Heating"

In this operating mode, the setpoint temperatures for Comfort, Standby and Night mode and the frost protection temperature can be preset ($T_{id} = L_{id}$).

The following applies

$$T_{\text{Standby setpoint heating}} \leq T_{\text{Comfort setpoint heating}}$$

or

$$T_{\text{Night setpoint heating}} \leq T_{\text{Comfort setpoint heating}}$$

The standby and night setpoint temperatures are derived from the reduction temperatures configured in the ETS from the comfort setpoint temperature (basic setpoint). The frost protection is supposed to prevent the heating system from freezing. For this reason the frost

protection temperature (default: +7 °C) should be to a set smaller value than the night temperature. In principle, however, it is possible to select frost protection temperature values between +7.0 °C and +40.0 °C. The possible range of values for a setpoint temperature lies between +7.0 °C and +99.9 °C for "heating" and is bounded by the frost protection temperature in the lower range.

The level offset configured in ETS will be additionally considered in a two-level heating mode (T-id= L-id=).

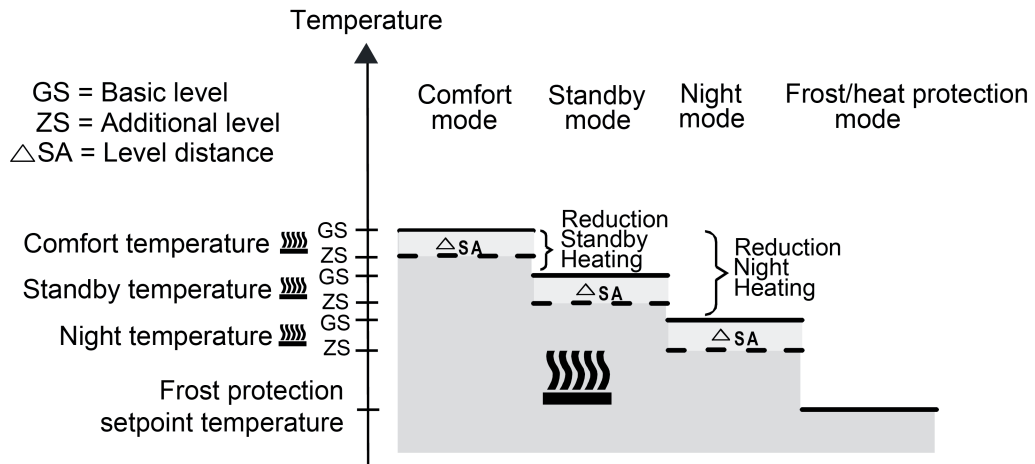

Figure 31: Setpoint temperatures in the operating mode "Basic and additional heating"

$$T_{\text{Comfort setpoint additional level heating}} \leq T_{\text{Comfort setpoint basic level heating}}$$

$$T_{\text{Standby setpoint additional level heating}} \leq T_{\text{Standby setpoint basic level heating}}$$

$$T_{\text{Standby setpoint heating}} \leq T_{\text{Comfort setpoint heating}}$$

or

$$T_{\text{Comfort setpoint additional level heating}} \leq T_{\text{Comfort setpoint basic level heating}}$$

$$T_{\text{Night setpoint additional level heating}} \leq T_{\text{Night setpoint basic level heating}}$$

$$T_{\text{Night setpoint heating}} \leq T_{\text{Comfort setpoint heating}}$$

Setpoints for the "cooling" operating mode

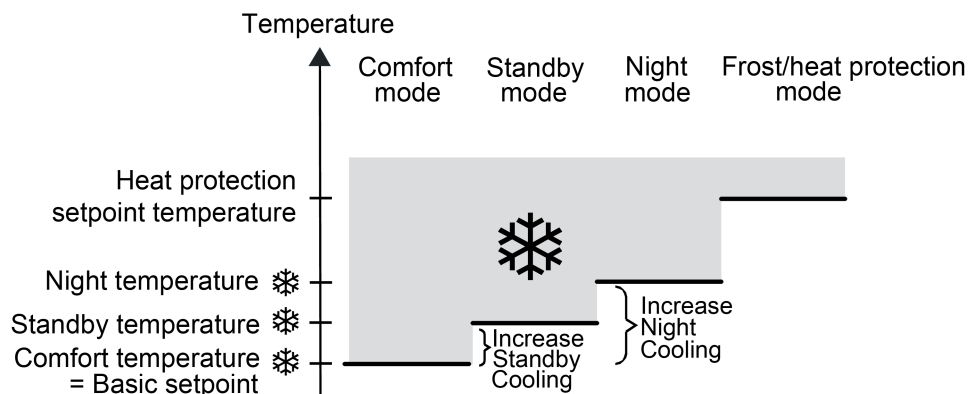

Figure 32: Setpoint temperatures in the operating mode "Cooling"

The setpoint temperatures for Comfort, Standby and Night mode exist in this operating mode and the heat protection temperature can be preset (T-id= L-id=). The following applies...

$$T_{\text{Comfort setpoint cooling}} \leq T_{\text{Standby setpoint cooling}}$$

or

$$T_{\text{Comfort setpoint cooling}} \leq T_{\text{Night setpoint cooling}}$$

The standby and night set-temperatures are derived after the configured increase temperatures from the comfort set-temperature (basic setpoint). The heat protection is supposed to ensure that the temperature does not exceed the maximum permissible room temperature in order to protect system components. For this reason the heat protection temperature (default: +35 °C) should be set to a larger value than the night temperature. In principle, however, it is possible to select heat protection temperature values between +7.0 °C and +45.0 °C. The possible range of values for a setpoint temperature lies between -99.9 °C and +45.0 °C for "cooling" and is bounded by the heat protection temperature in the upper range.

The level offset configured in ETS will be additionally considered in a two-level cooling mode (T-id= L-id=).

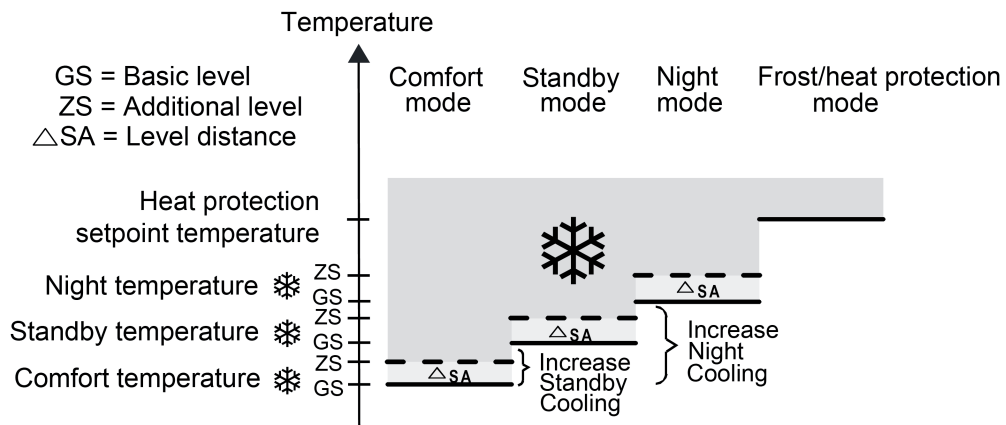

Figure 33: Setpoint temperatures in the operating mode "Basic and additional cooling"

$$T_{\text{Comfort setpoint basic level heating}} \leq T_{\text{Comfort setpoint additional level heating}}$$

$$T_{\text{Standby setpoint basic level heating}} \leq T_{\text{Standby setpoint additional level heating}}$$

$$T_{\text{Comfort setpoint cooling}} \leq T_{\text{Standby setpoint cooling}}$$

or

$$T_{\text{Comfort setpoint basic level heating}} \leq T_{\text{Comfort setpoint additional level heating}}$$

$$T_{\text{Night setpoint basic level heating}} \leq T_{\text{Night setpoint additional level heating}}$$

$$T_{\text{Comfort setpoint cooling}} \leq T_{\text{Night setpoint cooling}}$$

Setpoints for the "heating and cooling" operating mode

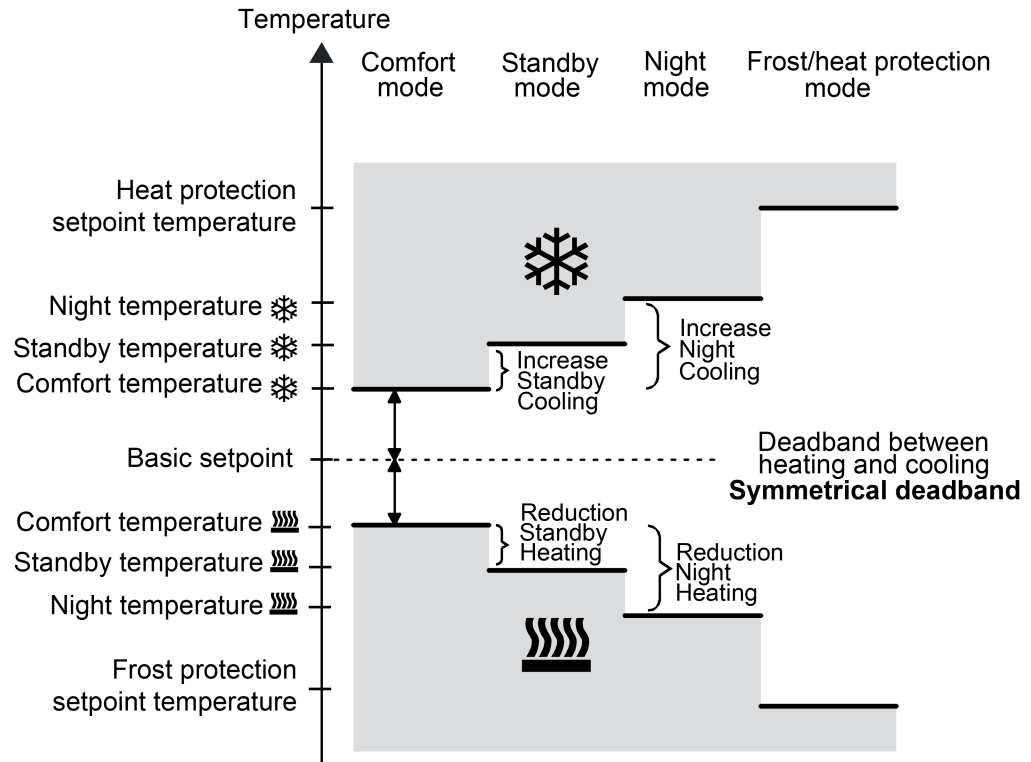

Figure 34: Setpoint temperatures in the operating mode "Heating and cooling" with symmetrical deadband

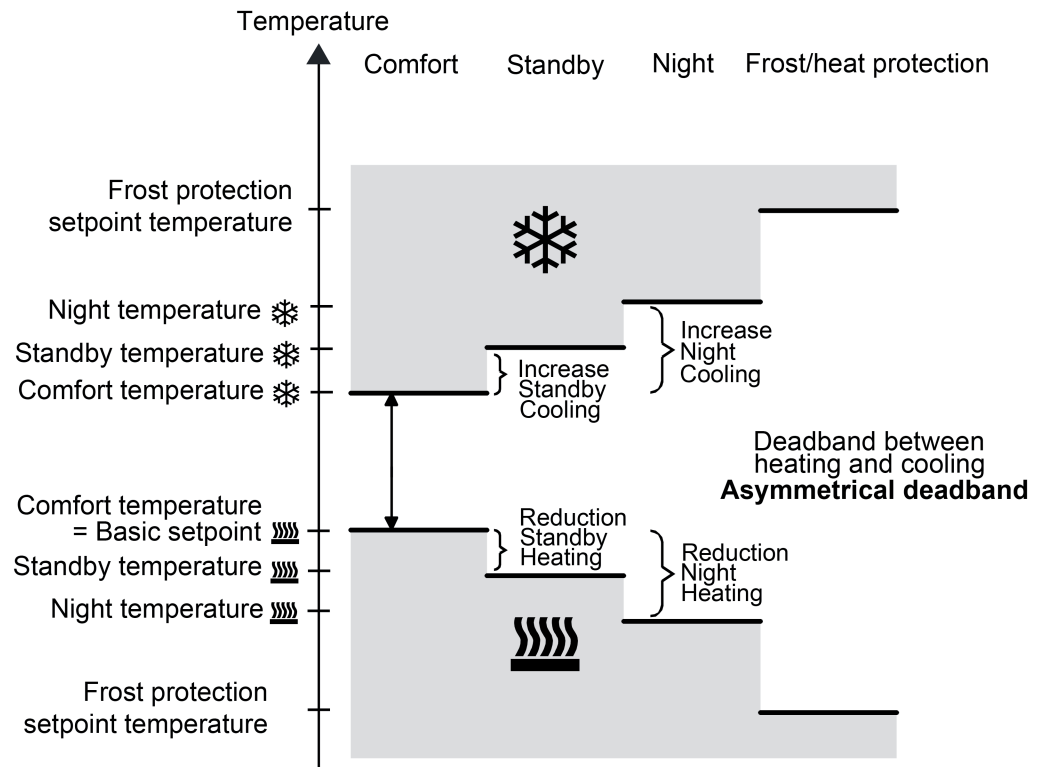

Figure 35: Setpoint temperatures in the operating mode "Heating and cooling" with asymmetrical deadband

For this heating/cooling operating mode, the setpoint temperatures of both heating/cooling modes exist for the Comfort, Standby and Night operating modes as well as the deadband. A distinction is made in the deadband position with combined heating and cooling. A symmetrical ($T_{-id=} = L_{-id=}$) or an asymmetrical ($T_{-id=} \neq L_{-id=}$) deadband position can be configured. In addition, the frost protection and the heat protection temperatures can be preset. The following applies...

$$T_{\text{Standby setpoint heating}} \leq T_{\text{Comfort setpoint heating}} \leq T_{\text{Comfort setpoint cooling}} \leq T_{\text{Standby setpoint cooling}}$$

or

$$T_{\text{Night setpoint heating}} \leq T_{\text{Comfort setpoint heating}} \leq T_{\text{Comfort setpoint cooling}} \leq T_{\text{Night setpoint cooling}}$$

The set-temperatures for "Standby" and "Night" are derived from the comfort setpoint temperatures for heating or cooling. The temperature increase (for cooling) and the temperature decrease (for heating) of both operating modes can be preset in ETS. The comfort temperatures itself are derived from the deadband and the basic setpoint.

The frost protection is supposed to prevent the heating system from freezing. For this reason the frost protection temperature (default: +7 °C) should be set to a smaller value than the night temperature for heating. In principle, however, it is possible to select frost protection temperature values between +7.0 °C and +40.0 °C. The heat protection is supposed to prevent the temperature from exceeding the maximum permissible room temperature in order to protect system components. For this reason the heat protection temperature (default: +35 °C) should be set to a larger value than the night temperature for cooling. In principle, however, it is possible to select heat protection temperature values between +7.0 °C and +45.0 °C.

The possible range of values for a setpoint temperature ("heating and cooling") lies between +7.0 °C and +45.0 °C and is bounded by the frost protection temperature in the lower range and by the heat protection temperature in the upper range.

The level offset configured in ETS will be additionally considered in a two-level heating or cooling mode.

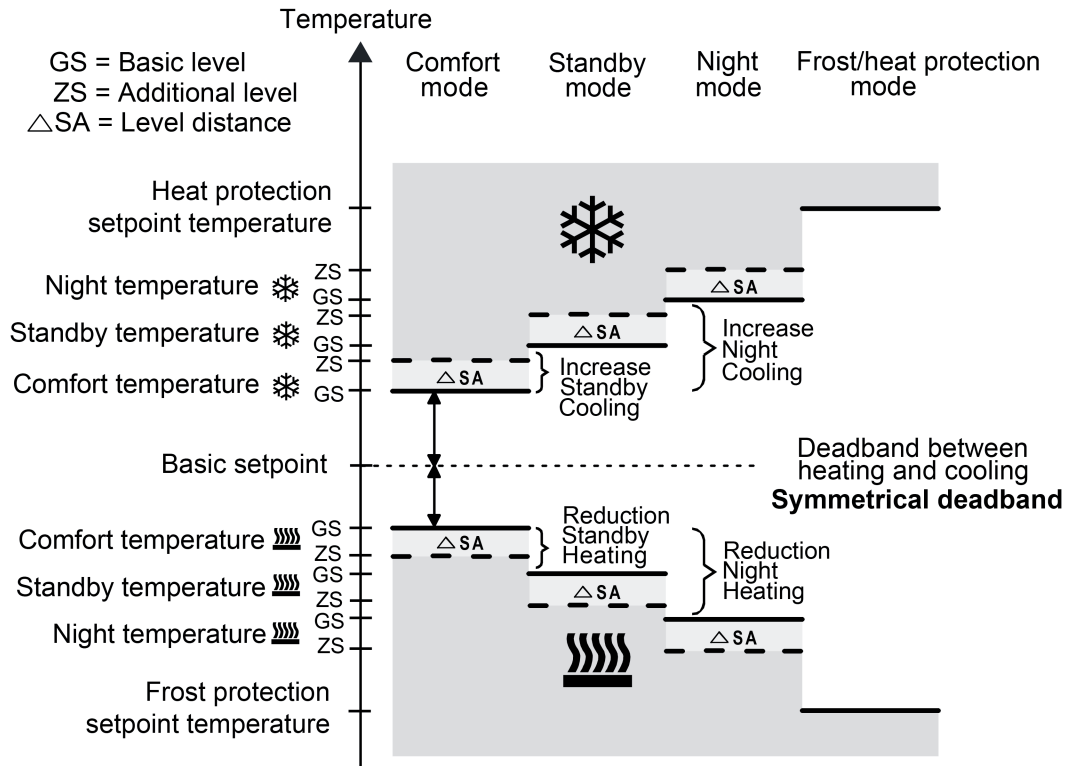

Figure 36: Setpoint temperatures in the operating mode "Basic and additional heating and cooling" with symmetrical deadband

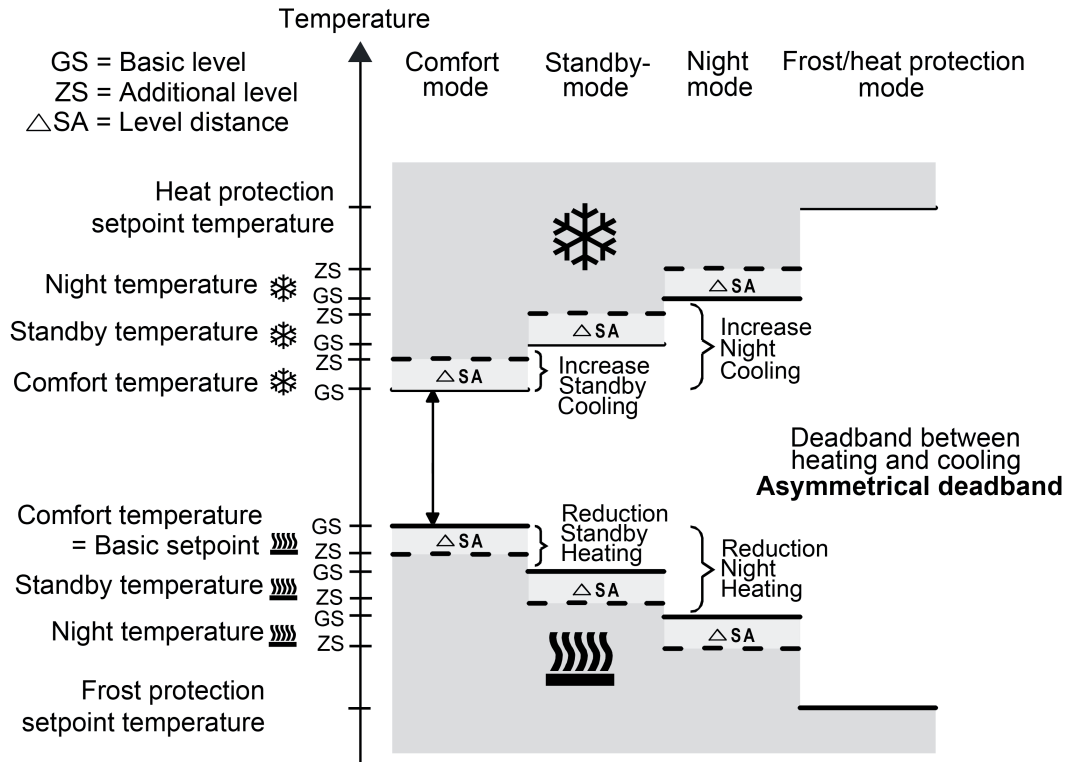

Figure 37: Setpoint temperatures in the operating mode "Basic and additional heating and cooling" with asymmetrical deadband

$$T_{\text{Comfort setpoint add. level Heating}} \leq T_{\text{Comfort setpoint basic level Heating}} \leq T_{\text{Comfort setpoint basic level Cooling}} \leq T_{\text{Comfort setpoint add. level Cooling}}$$

$$T_{\text{Standby setpoint add. level Heating}} \leq T_{\text{Standby setpoint basic level Heating}} \leq T_{\text{Standby setpoint basic level Cooling}} \leq T_{\text{Standby setpoint add. level Cooling}}$$

$$T_{\text{Standby setpoint heating}} \leq T_{\text{Comfort setpoint heating}} \leq T_{\text{Comfort setpoint cooling}} \leq T_{\text{Standby setpoint cooling}}$$

OR

$$T_{\text{Comfort setpoint add. level Heating}} \leq T_{\text{Comfort setpoint basic level Heating}} \leq T_{\text{Comfort setpoint basic level Cooling}} \leq T_{\text{Comfort setpoint add. level Cooling}}$$

$$T_{\text{Night setpoint add. level Heating}} \leq T_{\text{Night setpoint basic level Heating}} \leq T_{\text{Night setpoint basic level Cooling}} \leq T_{\text{Night setpoint add. level Cooling}}$$

$$T_{\text{Night setpoint heating}} \leq T_{\text{Comfort setpoint heating}} \leq T_{\text{Comfort setpoint cooling}} \leq T_{\text{Night setpoint cooling}}$$

deadband and deadband positions in the combined heating and cooling operating mode

With relative setpoint presetting, the comfort setpoint temperatures for heating and cooling are derived from the basic setpoint in consideration of the adjusted Dead band. The deadband (temperature zone for which there is neither heating nor cooling) is the difference between the comfort setpoint temperatures. This deadband does not exist for absolute setpoint presetting.

The "deadband between heating and cooling", "deadband position" parameters as well as the "Basic temperature after reset" parameter are preset in the ETS configuration. One distinguishes between the following settings...

- deadband = "symmetrical"

The deadband preset in the ETS is divided into two parts at the basic setpoint. The comfort set-temperatures are derived directly from the basic setpoint resulting from the half Dead band.

The following applies...

$$T_{\text{Basic setpoint}} - \frac{1}{2}T_{\text{deadband}} = T_{\text{Comfort heating setpoint}}$$

and

$$T_{\text{Basic setpoint}} + \frac{1}{2}T_{\text{deadband}} = T_{\text{Comfort setpoint cooling}}$$

$$\rightarrow T_{\text{Comfort cooling setpoint}} - T_{\text{Comfort heating setpoint}} = T_{\text{deadband}}$$

$$\rightarrow T_{\text{Comfort cooling setpoint}} \geq T_{\text{Comfort heating setpoint}}$$

- deadband position = "Asymmetrical"

With this setting the comfort setpoint temperature for heating equals the basic setpoint. The deadband preset in the ETS is effective only from the basic setpoint in the direction of comfort temperature for cooling. Thus the comfort set-temperature for cooling is derived directly from the comfort setpoint for heating.

The following applies...

$$T_{\text{Basic setpoint}} = T_{\text{Comfort heating setpoint}}$$

$$\rightarrow T_{\text{Basic setpoint}} + T_{\text{deadband}} = T_{\text{Comfort heating setpoint}}$$

$$\rightarrow T_{\text{Comfort cooling setpoint}} - T_{\text{Comfort heating setpoint}} = T_{\text{deadband}}$$

$$\rightarrow T_{\text{Comfort cooling setpoint}} \geq T_{\text{Comfort heating setpoint}}$$

Accept setpoints permanently

If the basic setpoint has been modified by the communication objects "Basic setpoint" or "Setpoint of active operating mode", two possible cases can be distinguished, which are set by the parameter "Apply change of the setpoint of the basic temperature" (with relative setpoint presetting) or "Apply change of the setpoint permanently" (with absolute setpoint presetting)...

- Case 1: The setpoint adjustment is permanently accepted ("Yes" setting):
If, with this setting, the temperature setpoint is adjusted, the controller saves the value permanently to the EEPROM (permanent storage). The newly adjusted value will overwrite the initial value, i.e. the basic temperature originally configured via the ETS after a reset or the absolute setpoint temperature loaded using the ETS. The changed values are also retained after a device reset, after a switch-over of the operating mode or after a switch-over of the heating/cooling mode (with absolute setpoint presetting individually for each operating mode for heating and cooling).
With this setting, it should be noted that frequent changing of the basic temperature (e.g. several times a day because of cyclical telegrams) can affect the product life of the device as the non-volatile storage is designed for less frequent write access.
The "Basic setpoint" object (relative setpoint presetting) is not bidirectional, meaning that a shifted basic setpoint is not signalled back to the KNX. The object "Setpoint active operating mode" (absolute setpoint presetting) can be bidirectional if necessary (set "Transmit" flag!). This makes it possible to use this object to feedback to the bus the setpoint temperature resulting from a setpoint shift.

 - Case 2: The basic setpoint adjustment is only temporarily accepted ("No" setting):
The setpoints received via the objects remain active only temporarily. In case of a bus voltage failure or following a switch-over to another operating mode (e.g. Comfort followed by Standby, or also Comfort followed by Comfort), or after a switch-over of the heating/cooling mode (e.g. heating after cooling), the last setpoint changed will be discarded and replaced by the initial value.
- i** If the setpoint is accepted on a non-temporary basis ("Yes" setting), the setpoints restored after a device reset are not effected immediately in the communication objects. Only after the telegrams have been received from the bus via the objects and the room temperature controller accepts the newly received setpoint can the objects be read out, for example for visualisation purposes (Set "Read" flag!).
 - i** With relative setpoint presetting: Independent of the "accept modification of the basic temperature setpoint value permanently" parameter, the temperature setpoints for the standby or night mode or "cooling" comfort mode (deadband) will always be stored in the non-volatile EEPROM memory.
With absolute setpoint presetting: As described, dependent on the "accept modification of the setpoint value permanently" parameter, the temperature setpoints for the standby or night mode for heating or cooling will always be stored in the volatile or non-volatile memory.

Basic setpoint shift for relative setpoint presetting

In addition to presetting individual temperature setpoints by the ETS or basic setpoint object, the user, when presetting relative setpoints, can shift the basic setpoint in predefined limits within a specific range. When doing so, the basic setpoint is adjusted up or down in increments. The value of a level can be adjusted to 0.1 K or 0.5 K by the parameter "Value of the setpoint shift".

- i** No basic setpoint shift can be performed if the controller is configured for absolute setpoint presetting.

- i** It has to be considered that a shift of the displayed setpoint temperature (temperature offset of the basic temperature) will directly affect the basic setpoint and as a result shift all other temperature setpoints.
A positive shift is possible up to the configured heat protection temperature. A negative shift is possible up to the set frost protection temperature.
- i** The "Basic setpoint" object is not bidirectional, meaning that a shifted basic setpoint is not signalled back to the KNX.

Whether a basic setpoint shifting only affects the currently active operating mode or whether it influences all other set-temperatures of the remaining operating modes is determined by the "Accept modification of shift of basic setpoint value permanently" parameter in the "Room temperature control -> Controller general -> Setpoints" parameter page...

- "No" setting:
The basic setpoint shifting carried out is in effect for only as long as the operating mode or heating/cooling mode has not changed or the basic setpoint is maintained. Otherwise the setpoint shift will be reset to "0".
 - "Yes" setting:
In general, the shifting of the basic setpoint carried out affects all operating modes. The shifting is maintained even after change-over of the operating mode or the heating/cooling mode or readjusting the basic setpoint.
- i** Since the value for the basic setpoint shift is stored exclusively in volatile memory (RAM), the shift will get lost in case of a reset (e.g. bus voltage failure).
 - i** A setpoint shift does not affect the temperature setpoints for frost or heat protection!

Communication objects for the basic setpoint shift:

The setpoint shift of the controller can be adjusted externally by the communication object "Setpoint shift specification" with a 1-byte counter value (in compliance with KNX DPT 6.010 – Depiction of positive and negative values in a double complement. By connecting to the "Setpoint shift specification" object the controller extensions are able to directly adjust the current setpoint shift of the controller. As soon as the controller receives a value, it will adjust the setpoint shift correspondingly. Values that lie within the possible value range of the basic setpoint shift can be directly jumped to.

The controller monitors the received value independently. As soon as the external preset value exceeds the limits of the adjustment options for the setpoint shift in positive or negative direction, the controller will correct the received value and adjust the setpoint shift to maximum. Depending on the direction of the shift, the value feedback is set to the maximum value via the communication object "Current setpoint shift".

The current setpoint shift is tracked by the controller in the communication object "Current setpoint shift". This object has the same data point type and value range as the object "Setpoint shift specification" (see above). By connecting to this object the controller extensions are also able to display the current setpoint shift. As soon as there is an adjustment by one temperature increment in positive direction, the controller counts up the value. The counter value will be counted down if there is a negative adjustment of the temperature. A value of "0" means that no setpoint shift has been adjusted.

Example:

Initial situation: Current setpoint temperature = 21.0 °C / value of the setpoint shift = 0.5 K / /

counter value in the object "Current setpoint shift" = "0" (no setpoint shift active)

After the setpoint shift:

-> A setpoint shift by one temperature increment in the positive direction will count up the value in the "Current setpoint shift" object by one = "1".

-> Current setpoint temperature = 21.5°C

-> An additional setpoint shift by one temperature increment in the positive direction will again count up the value in the "Current setpoint shift" object by one = "2".

-> Current setpoint temperature = 22.0°C

-> A setpoint shift by one temperature increment in the negative direction will count down the value in the "Current setpoint shift" object by one = "1".

-> Current setpoint temperature = 21.5°C

-> An additional setpoint shift by one temperature increment in the negative direction will again count down the value in the "Current setpoint shift" object by one = "0".

-> Current setpoint temperature = 21.0°C

-> An additional setpoint shift by one temperature increment in the negative direction will again count down the value in the "Current setpoint shift" object by one = "-1".

-> Current setpoint temperature = 20.5°C, etc. ...

- i** To ensure that controller extensions indicate the correct shifts and also control the functions of the controller (as main unit) correctly, it is necessary for the controller extensions to be set to the same shift limits of the setpoint shift as the main unit. Controller extensions must also be set to the same step width for the setpoint shift as the controller itself (0.1 K or 0.5 K).

Transmitting the setpoint temperature

The setpoint temperature, which is given by the active operating mode can be actively transmitted onto the bus via the 2-byte "Set temperature" object. The "Transmission at setpoint temperature modification by..." parameter in the "Room temperature control -> controller general -> setpoint values" parameter node determines the temperature value by which the setpoint has to change in order to have the setpoint temperature value transmitted automatically via the object. Possible temperature value changes lie within a range of 0.1 K and 25.5 K. The setting "0" at this point will deactivate the automatic transmission of the set temperature.

In addition, the setpoint can be transmitted cyclically. The "Cyclical transmission of setpoint temperature" parameter determines the cycle time (1 to 255 minutes). The value "0" will deactivate the periodical transmission of the setpoint temperature value. It has to be pointed out that with deactivated periodical transmission and deactivated automatic transmission, no setpoint temperature telegrams will be transmitted in case of a change.

Setting the "Read" flag on the "Setpoint temperature" object makes it possible to read out the current setpoint. Following the return of bus voltage or after re-programming via the ETS, the object value will be initialised according to the current setpoint temperature value and actively transmitted to the bus.

4.2.4.4.6 Room temperature measurement

Basic principles

The room temperature regulator periodically measures the actual temperature of the room and compares it with the given setpoint temperature of the active operating mode. The control algorithm calculates the adjusted command value from the difference between actual and setpoint temperatures. In order to ensure a fault-free and effective room temperature control, it is very important to determine the exact actual temperature.

The room temperature controller possesses an integrated temperature sensor, using which the room temperature can be detected. Alternatively (e.g. if the room temperature controller has been installed in an unfavourable location or operates in difficult conditions, for example, in a moist atmosphere) or in addition (e.g. in large rooms or halls), a second temperature sensor linked via bus telegrams can be used to determine the actual value. This second sensor can either be a room temperature controller coupled via the KNX or a controller extension with temperature recording.

When choosing the installation location of the controller or the external sensor, the following points should be considered...

- The controller or temperature sensor should not be used in multiple combinations, especially together with concealed dimmers.
- Do not install the temperature sensor in the area of large electrical consumers (avoid heat influences).
- The push button sensor should not be installed in the vicinity of radiators or cooling systems.
- The temperature sensor should not be exposed to direct sun.
- The installation of sensors on the inside of an outside wall might have a negative impact on the temperature measurement.
- Temperature sensors should be installed at least 30 cm away from doors, windows or ventilation units and at least 1.5 m above the floor.

i Room temperature measurement by the device is always active, irrespective of the "Room temperature control" function and can thus be used independently (e.g. for simple measurement and display of a room temperature without control).

Temperature detection and measured value formation

The parameter "Temperature detection" in the parameter node "Sensor -> Temperature detection" specifies by which the sensor the room temperature is determined.

The following settings are possible for temperature detection

- "Internal sensor"
The temperature sensor integrated in the room temperature controller is activated. Thus, the actual temperature value is determined only locally on the device.
In this parameterisation the feedback control will start directly after a device reset.

- "received temperature value"
The actual temperature is determined solely via a temperature value received from the bus. In this case, the sensor must either be a KNX room thermostat coupled via the 2-byte object "Received temperature" or a controller extension with temperature detection. The room temperature controller can request the current temperature value cyclically. For this purpose, the parameter "Request time of the received temperature value" must be set to a value > "0". The request interval can be configured within the limits of 1 minute to 255 minutes.
After a device reset the room temperature controller will first wait for a valid temperature telegram until the feedback control starts and a command value, if applicable, is output.

- "internal sensor + received temperature value"
This setting is used to combine the selected temperature sources. The sensors can either be a KNX room thermostat coupled via the 2-byte object "received temperature" or controller extensions with temperature detection. With the setting "Received temperature value" the room temperature controller can request the current temperature value cyclically. For this purpose, the parameter "Request time of the received temperature value" must be set to a value > "0". The request interval can be configured within the limits of 1 minute to 255 minutes. After a device reset the room temperature controller will first wait for a valid temperature telegram until the feedback control starts and a command value, if applicable, is output. When evaluating, the real actual temperature is made up from the two respective measured temperature values. At the same time, the weighting of the temperature values is defined by the parameter "Measured value formation to receive internally". Depending on the different locations of the sensors or a possible non-uniform heat distribution inside the room, it is thus possible to adjust the actual temperature measurement. Often, those temperature sensors that are subject to negative external influences (for example, unfavourable location because of exposure to sun or heater or door / window directly next to it) are weighted less heavily.

Example: a room temperature controller is installed next to the entrance to the room (internal sensor). An additional wired temperature sensor has been mounted on an inner wall in the middle of the room below the ceiling.

Internal sensor: 21.5 °C

External sensor: 22.3 °C

Determination of measured value: 30 % to 70 %

$$\rightarrow T_{\text{Result internal}} = T_{\text{internal}} \cdot 0.3 = 6.45 \text{ °C,}$$

$$\rightarrow T_{\text{Result external}} = T_{\text{external}} \cdot 0.7 = 15.61 \text{ °C}$$

$$\rightarrow T_{\text{Result actual}} = T_{\text{Result internal}} + T_{\text{Result external}} = \underline{22.06 \text{ °C}}$$

Calibrating the measured values

In some cases during room temperature measurement, it may be necessary to adjust the single temperature values. Adjustment becomes necessary, for example, if the temperature measured by the sensors stays permanently below or above the actual temperature in the vicinity of the sensor. To determine the temperature deviation, the actual room temperature should be detected with a reference measurement using a calibrated temperature measuring device. The parameters "Calibration of internal sensors" and "Calibration of received temperature value" in the parameter node "Sensor -> Temperature measurement" can parameterise the positive (temperature increase, factors: 1 ... 127) or negative (temperature decrease, factors -128... -1) temperature calibration in levels of 0.1 K. Thus, the calibration is made only once statically and is the same for all operating modes of the controller.

- i** The measured value has to be increased, if the value measured by the sensor lies below the actual room temperature. The measured value has to be decreased, if the value measured by the sensor lies above the actual room temperature.

- i** During room temperature control, the controller always uses the adjusted temperature value to calculate the command values. The adjusted temperature value is transmitted to the bus via the "Actual temperature" object (see "Transmission of the actual temperature"). When determining the measured value using combined sensors, the two adjusted values are used to calculate the actual value.
- i** The object value of the communication object No. 80 (s.measured value for temperature) is the determined and corrected temperature value of the integrated sensor (self-heating). The parameter "Calibration of internal temperature sensors" is added to the object value as offset.
- i** The object value of the communication object No. 23 (actual temperature) is the read out value of the communication object No. 80 (S.measured value for temperature), to which the parameterised calibration value was already applied. The application of a parameterised evaluation and weighting might possibly still take place. This temperature value serves as the actual temperature for the room temperature controller function
- i** The object value of the communication object No. 59 (actual temperature non-calibrated) is the read out value of the communication object No. 80 (S.measured value for temperature) without temperature calibration. This value is the actual room temperature measured by the internal temperature sensor.

Transmission of the actual temperature

The determined actual temperature can be actively transmitted to the bus via the 2-byte "Actual temperature" object. The parameter "Transmission when room temperature change by..." in the parameter node "Sensor -> Temperature measurement" defines the temperature value by which the actual value must change so that the actual temperature value is transmitted automatically via the object. Possible temperature value changes lie within a range of 0.1 K and 25.5 K. The setting to "0" at this point will deactivate the automatic transmission of the actual-temperature.

In addition, the actual value can be transmitted periodically. The "Cyclical transmission of the room temperature" parameter determines the cycle time (1 to 255 minutes). The value "0" will deactivate the periodical transmission of the actual temperature value.

Setting the "Read" flag on the "actual temperature" object makes it possible to read out the current actual value at any time over the bus. It has to be pointed out that with deactivated periodical transmission and deactivated automatic transmission, no more actual-temperature telegrams will be transmitted".

Following the return of bus voltage, new programming via the ETS, the object value will be updated according to the actual temperature value and transmitted on the bus. During room temperature control, the controller always uses the adjusted temperature value to calculate the command values. The adjusted temperature value is transmitted to the bus via the "Actual temperature" object.

If, when using a separate KNX sensor, no temperature value telegram of the separate sensor was received, only the value formed by the internal sensor is transmitted. If the separate sensor is used exclusively, the value "0" is in the object after a reset. For this reason, the separate KNX temperature sensor should always transmit the current value after a reset.

4.2.4.4.7 Command value and status output

Command value objects

The format of the command value objects are determined depending on the control algorithm selected for heating and / or cooling and, if applicable, also for the additional levels. 1 bit or 1 byte command value objects can be created in the ETS. The control algorithm calculates the command values in intervals of 30 seconds and outputs them via the objects. With the pulse width modulated PI control (PWM) the command value is updated, if required, solely at the end of a time cycle.

Possible object data formats for the command values separately for both heating/cooling operating modes, for the basic and the additional level or for both control circuits are...

- Continuous PI control: 1 byte
- Switching PI control: 1 bit + additionally 1 byte (for example for the status indication with visualisations),
- Switching 2-point feedback control: 1 bit.

Depending on the selected heating/cooling operating mode, the controller is able to address heating and / or cooling systems, to determine command values and to output them via separate objects. One distinguishes between two cases for the "Heating and cooling" mixed operating mode...

- Case 1: Heating and cooling system are two separate systems
In this case the "Transmit heating and cooling command value to one common object" parameter should be set to "No" in the "Room temperature controller -> Controller functions" parameter node. Thus, there are separate objects available for each command value, which can be separately addressed via the individual systems.
This setting allows to define separate types of control for heating and cooling.
- Case 2: Heating and cooling system are a combined system
In this case the "Transmit heating and cooling command value to one common object" parameter may be set, if required, to "Yes". This will transmit the command values for heating and cooling to the same object. In case of a two-level feedback control, another shared object will be enabled for the additional levels for heating and cooling.
With this setting it is only possible to define the same type of feedback control for heating and for cooling as the feedback control and the data format must be identical. The ("Type of heating / cooling") control parameter for cooling and heating still has to be defined separately.
A combined command value object may be required, for example, if heating as well as cooling shall take place via a single-pipe system (combined heating and cooling system). For this, the temperature of the medium in the single-pipe system must be changed via the system control. Afterwards the heating/cooling operating mode is set via the object (often the single-pipe system uses cold water for cooling during the summer, hot water for heating during the winter).

If required, the command value can be inverted before the transmission to the KNX. With output via a combined object, the parameters "Output of heating command value", "Output of cooling command value" or "Output of command values..." output the command value in inverted fashion according to the object data format. The parameters for inverting the additional level(s) are additionally available in the two-level control.

The following applies...

For continuous command values:

-> Not inverted: Command value 0 % ... 100 %, value 0 ... 255

-> Inverted: Command value 0 % ... 100 %, value 255 ... 0

For switching command values:

-> Not inverted: Command value off / on, value 0 / 1

-> Inverted: Command value off / on, value 1 / 0

Automatic transmission

On automatic transmission of the command value telegrams, a distinction is made with regard to the type of control...

- **Continuous PI control:**
In case of a continuous PI control, the room temperature controller calculates a new command value periodically every 30 seconds and outputs it to the bus via a 1-byte value object. The change interval of the command value can be determined in percent according to which a new command value is to be output on the bus via the "Automatic transmission on change by..." parameter in the "Room temperature controller -> Controller general -> Command values and status output" parameter node. The change interval can be configured to "0" so that a change in the command value will not result in an automatic transmission.
In addition to the command value output following a change, the current command value value may be periodically transmitted on the bus. In addition to the times when changes are to be expected, other command value telegrams will be output according to the active value after a configurable cycle time. This ensures that during a periodic access control of the command value in servo drive or in the addressed switching actuator, telegrams are received within the control interval. The time interval predetermined by the "Cycle time for automatic transmission..." parameter parameter should correspond to the control interval in the actuator (cycle time in the controller is preferably to be parameterized smaller). The "0" setting will deactivate the periodic transmission of the actuating variable.
With continuous PI control it must be noted that if the cyclical and the automatic transmission are both deactivated, no command value telegrams will be transmitted in case of a change!

- **Switching PI control (PWM):**
In case of a switching PI control (PWM), the room temperature controller calculates a new command value internally every 30 seconds. In this feedback control, however, the update of the command value takes place, if required, solely at the end of a PWM cycle. The parameters "automatic transmission on change by..." and "Cycle time for automatic transmission..." are not enabled with this control algorithm. The parameter "Cycle time of the switching command value..." defines the cycle time of the PWM command value signal.

- **2-point control:**
In case of a 2-point feedback control, the room temperature and thus the hysteresis values are evaluated periodically every 30 seconds, so that the command values, if required, will change solely during these times. The "Automatic transmission on change by..." parameter is not enabled as this control algorithm does not calculate continuous command values.
In addition to the command value output following a change, the current command value value may be periodically transmitted on the bus. In addition to the times when changes are to be expected, other command value telegrams will be output according to the active value after a configurable cycle time. This ensures that during a periodic access control of the command value in servo drive or in the addressed switching actuator, telegrams are received within the control interval. The time interval predetermined by the "Cycle time for automatic transmission..." parameter parameter should correspond to the control interval in the actuator (cycle time in the controller is preferably to be parameterized smaller). The "0" setting will deactivate the periodic transmission of the actuating variable.

Controller status

The room temperature controller can transmit its current status to the KNX/EIB. A choice of data formats is available for this. The "Controller status" parameter in the "Room temperature controller -> Controller general -> Command value and status output" parameter branch will enable the status signal and set the status format...

- "KNX compliant"
The KNX compliant controller status feedback is harmonised on a manufacturer-specific basis, and consists of 3 communication objects. The 2-byte object "KNX status" (DPT 22.101) indicates elementary functions of the controller (see Table 7). This object is supplemented by the two 1-byte objects "KNX status operating mode" and "KNX status forced operating mode" (DPT 20.102), which report back the operating mode actually set on the controller. The last two objects mentioned above are generally used to enable controller extensions to display the controller operating mode correctly in the KNX compliant status display. Therefore these objects should be connected with controller extensions if the KNX compliant status feedback is not configured.

Bit of the status telegram	Meaning
0	Controller error status ("0" = no error / "1" = error)
1	not used (permanent "0")
2	not used (permanent "0")
3	not used (permanent "0")
4	not used (permanent "0")
5	not used (permanent "0")
6	not used (permanent "0")
7	not used (permanent "0")
8	Operating mode ("0" = Cooling / "1" = Heating)
9	not used (permanent "0")
10	not used (permanent "0")
11	not used (permanent "0")
12	Controller disabled (dew point operation) ("0" = Controller enabled / "1" = Controller disabled)
13	Frost alarm ("0" = Frost protection temperature exceeded / "1" = frost protection temperature undershot)
14	Heat alarm ("0" = heat protection temperature exceeded / "1" = Heat protection temperature exceeded)
15	not used (permanent "0")

Table 7: Bit encoding of the 2 byte KNX compliant status telegram

- "Controller general":
The general controller status collects essential status information of the controller in two 1-byte communication objects. The "Controller status" object contains fundamental status information (see Table 8). The "Status signal addition" object collects in a bit-orientated manner further information that is not available via the "Controller status" object (see Table 9). For example, controller extensions can evaluate the additional status information, in order to be able to display all the necessary controller status information on the extension display.

Bit of the status telegram	Meaning
0	On "1": Comfort operation activated
1	On "1": Standby mode active
2	On "1": Night mode active
3	On "1": Frost/heat protection mode active
4	On "1": Controller disabled
5	On "1": Heating, on "0": Cooling
6	On "1": Controller inactive (deadband)
7	On "1": Frost alarm ($T_{\text{Room}} \leq +5 \text{ }^{\circ}\text{C}$)

Table 8: Bit encoding of the 1 byte status telegram

Bit of the status telegram	Meaning on "1"	Meaning on "0"
0	Normal operating mode	Forced operating mode
1	Comfort extension active	No comfort extension
2	Presence (Motion detector)	No presence (Motion detector)
3	Presence (Presence button)	No presence (Presence button)
4	Window opened	No window opened
5	Additional level active	Additional level inactive
6	Heat protection active	Heat protection inactive
7	Controller disabled (dew point operation)	Controller not disabled

Table 9: Bit encoding of the 1 byte additional status telegram

- "Transmit individual state"
The 1 bit status object "Controller status, ..." contains the status information selected by the "Single status" parameter. Meaning of the status signals:
 - "Comfort mode active" -> Active if operating mode "Comfort " or a comfort extension "" is activated.
 - "Standby mode active" -> active if the "standby " operating mode is activated.
 - "Night-mode active" -> active if the "night " operating mode is activated.
 - "Frost/heat protection active" -> active if the "frost/heat protection" operating mode is activated.
 - "Controller disabled" -> Active if controller disable is activated (dew point mode).
 - "Heating / cooling" -> Active if heating is activated and inactive if cooling is activated. Inactive if controller is disabled.
 - "Controller inactive" -> Active with the "heating and cooling" operating mode when the measured room temperature lies within the dead zone. This status information is always "0" for the individual "Heating" or "Cooling" operating modes. Inactive if controller is disabled.
 - "Frost alarm" -> Is active if the detected room temperature reaches or falls below +5 °C. This status signal will have no special influence on the control behaviour.

- i** Upon a reset, the status objects will be updated after the initialisation phase. After this, updating is performed cyclically every 30 seconds in parallel with the command value calculation of the controller command values. Telegrams are only transmitted to the bus when the status changes.

Command value limit

Optionally a command value limit can be configured in the ETS. The command value limit allows the restriction of calculated command values to the range limits "minimum" and "maximum". The limits are permanently set in the ETS and, if command value limitation is active, can be neither undershot or exceeded during device operation. It is possible, if available, to specify various limiting values for the basic and additional stages and for heating and cooling.

- i** It should be noted that the command value limit has no effect with "2-point feedback control" and with "Transmitting of command values for heating and cooling via a common object"! In that case it is still possible to configure the command value limit in the ETS, but it will have no function.

The "Command value limit" parameter on the parameter page "Room temperature control -> Controller general -> Command values and status output" defines the mode of action of the limiting function. The command value limit can either be activated or deactivated using the 1-bit communication object "Command value limit", or be permanently active. When controlling via the object, it is possible to have the controller activate the command value limit automatically after bus voltage return or an ETS programming operation. Here the "Command value limit after reset" parameter defines the initialisation behaviour. In the "Deactivated" setting, the command value limit is not automatically activated after a device reset. A "1" telegram must first be received via the "Command value limit" object for the limit to be activated. In the "Activated" setting, the controller activates the command value limit automatically after a device reset. To deactivate the limit a "0" telegram must be received via the "Command value limit" object. The limit can be switched on or off at any time using the object.

With a permanently active command value limit, the initialisation behaviour cannot be configured separately after a device reset, as the limit is always active. In this case it is also not possible to configure any object.

As soon as the command value limit is active, calculated command values are limited according to the limiting values from the ETS. The behaviour with regard to the minimum or maximum command value is then as follows...

- Minimum command value:
The "Minimum command value" parameter specifies the lower command value limiting value. The setting can be made in 5 % increments in the range 5 % ... 50 %. With an active command value limit, the set minimum command value is not undershot by command values. If the controller calculates smaller command values, it sets the configured minimum command value. The controller transmits a 0% command value if no more heating or cooling energy has to be demanded.

- Maximum command value:
The "Maximum command value" parameter specifies the upper command value limiting value. The setting can be made in 5 % increments in the range 55 % ... 100 %. With an active command value limit, the set maximum command value is not exceeded. If the controller calculates larger command values, it sets the configured maximum command value.

If the limit is removed, the device automatically repositions the most recently calculated command value to the unlimited values when the next calculation interval for the command values (30 seconds) has elapsed.

- i** If the controller executes a valve protection function, the command value limit is temporarily deactivated in order to make use of the full motion range of the valve.
- i** An active command value limit has a negative effect on the control result when the command value range is very restricted. A control deviation must be expected.

Special case for command value 100% (Clipping mode)

If with a PI control the calculated command value of the controller exceeds the physical limits of the actuator, in other words if the calculated command value is greater than 100%, then the command value is set to the maximum value (100%) and thus limited. This special, necessary control behaviour is also called "clipping". With PI control the command value can reach the value "100%" if there is a large deviation of the room temperature from the setpoint temperature or the controller requires a long time to adjust to the setpoint with the heating or cooling energy that is being applied. The controller can evaluate this state in a particular manner and react to it in various ways.

The parameter "Behaviour with command value = 100% (clipping mode PI control)" on the parameter page "Room temperature control -> Controller general -> Command values and status output" defines the functions of the PI controller when the command value is 100%...

- "keep 100% until setpoint = actual, then 0%" setting:
The controller keeps the maximum command value until the room temperature (actual value) reaches the setpoint temperature. After that it reduces the command value down to 0% all at once (controller reset).
The advantage of this control behaviour is that in this way sustainable heating up of undercooled rooms or effective cooling of overheated rooms will be achieved by overshooting the setpoint. The disadvantage is that in some circumstances the overshooting of the room temperature may be found disturbing.

- Setting "keep 100% as required, then adjust downwards":
The controller maintains the maximum command value only as long as it is necessary. After that it adjusts the command value downwards according to the PI algorithm. The advantage of this control characteristic is the fact that the room temperature does not exceed the setpoint temperature at all, or only slightly. The disadvantage is that this control principle increases the tendency to oscillate about the setpoint.

Which of the methods of functioning described above is used often depends on what heating or cooling system is used (underfloor heating, radiators, fan coils, cooling ceilings, etc.), and how effective these systems are. We recommend selecting the setting "keep 100% until setpoint = actual, then 0%" (default setting). Only if this control behaviour has an adverse effect on the people's perception of the temperature in a room should the setting "keep 100% as required, then adjust downwards" be used.

- i** Clipping may also occur when a command value limit is active (maximum command value). In this case, if the internally calculated command value reaches 100%, then the controller only transmits to the bus the maximum command value according to the ETS configuration. The clipping (switching off when setpoint = actual or adjusting downwards) is performed, however.
- i** It should be noted that the clipping mode has no effect with "2-point feedback control"! In that case it is still possible to configure the parameter "Behaviour with command value = 100%" in the ETS, but it will have no function.

4.2.4.4.8 Disable functions of the room temperature controller

Disable controller

Certain operation conditions may require the deactivation of the room temperature control. For example, the controller can be switched-off during the dew point mode of a cooling system or during maintenance work on the heating or cooling system. The parameter "Switch off controller (dew point operation)" in the parameter node "Room temperature control -> Controller functionality" enables the 1-bit object "Disable controller" when set to "Via bus". In addition, the controller disable function can be switched off when set to "No".

In case a "1" telegram is received via the enabled disable object, the room temperature controller will be completely deactivated. In this case, the command values are equal "0" (wait 30 s for update interval of the command values). The controller, however, can be operated in this case.

The additional level can be separately disabled when in two-level heating or cooling mode. When set to "Yes", the "Additional level disabling object" parameter in the "Room temperature controller -> Controller general" parameter node will enable the 1 bit "Disable additional level" object. In addition, the disable function of the additional level can be switched off when set to "No". In case a "1" telegram is received via the enabled disable object, the room temperature controller is completely deactivated by the additional level. The command value of the additional level is "0" while the basic level continues to operate.

-  A disable is always deleted after a reset (return of bus voltage, ETS programming operation).

4.2.4.4.9 Valve protection

Valve protection may be carried out periodically in order to prevent the addressed control valves of the heater or cooling system to become calcified or stuck. When set to "Yes", the "Valve protection" parameter in the "Room temperature controller -> Controller functionality" parameter node activates valve protection.

This type of protection is generally started not only for non-active command value objects, i.e. for objects which have not requested any heating or cooling energy over the past 24 hours. For these objects, by taking into account the following parameterisation the controller will periodically set the command value to the maximum value once a day for a duration of approx. 5 minutes.

Command value output not inverted:

-> 1-bit command value: "1", 1-byte command value: "255"

Command value output inverted:

-> 1-bit command value: "0", 1-byte command value: "0"

Thus even long closed valves will be opened briefly on a regular basis.

- i A controller disable has no influence on the valve protection. This means that valve protection is carried out, even when the controller is disabled.
- i The controller checks the 24-h time cycle for the valve protection based on a 24-hour counter. (Owing to inaccuracies, it can be assumed that this time will shift.) After a reset of the device (programming with the ETS or return of bus voltage), this will be reset automatically and restarted.

4.2.4.5 Logic gate

Logic gates

In order to implement logical dependencies from external states as well or to cascade, the device software has four logic gates. Each gate can have from one to a maximum of four inputs. For each logic gate, the type of logic operation "AND", "OR", "exclusive OR", "AND with feedback" can be set. In addition, each input can be operated normally or inverted.

The communication objects of the outputs can be configured as 1-bit or 1-byte objects. Switching outputs can also work inverted. The inputs can be used separately with their own communication objects. Alternatively, an input can be assigned to a limiting value, dew point alarm or 1-bit logic gate output. The outputs can work with a time delay. The transmission criterion for input event, output change and cyclical transmission can be set.

For more complex functions it is possible to combine a number of logic gates. Feedback, i.e. connecting an output with an input of the same gate (poss. also via other logic gates) is not prevented by the configuration software. This does not interfere with the other device functions.

- i** Because feedback can lead to a very large number of telegrams, reasonable switch-on or switch-off delays should be set in such cases.
- i** As a rule, a logic operation is only evaluated when an input telegram is received. If a feedback with a cyclically sending output is created, it may occur that the device will send telegrams independently after the application is loaded or after a reset. In this case, too, switch-on or switch-off delays are highly advisable.
- i** With an "AND with return" the value of the output is fed back internally to input 1. The result of this is that the output can only have the value "1" again if input 1 is set to "1" after the value "1" is already present on all of the other inputs. As soon as one of the other inputs is given the value "0", the output and thus input 1 is set to "0" because of the feedback. Example: A luminaire that should first be switched on manually at dusk and switched off again automatically at dawn. Here the pushbutton is linked to input 1 and the limiting value of the twilight sensor is linked to input 2. After the twilight sensor has set input 2 to "1", the pushbutton on input 1 can be used to switch on the light. If the user forgets to switch the light off again manually, when daylight comes the feedback ensures that input 1 is reset internally to "0". Without this feedback the light would be switched on again automatically at the next twilight.

Parametrizing logic gates

The following settings must be made in order to use a logic gate...

- Configure the "Number of logic gates" required (max. four) on the parameter page "Configure logic gates".

On the parameter page "Logic gates -> Logic gates X"...

- Select the "Type of logic operation".
- In the parameter "Number of inputs", select a number of inputs between 1 and 4.
- Select the number of outputs and data format in the parameter "Number and type of output objects".
- In parameter "Send output when", select under what precondition the output object should be sent.
- Set the parameter "Transmission behaviour for logic "1".
- Set the parameter "Transmission behaviour for logic "0".

- i** When using the delays, ensure that the time delays can be retriggered. Thus, in the case of "Transmission behaviour for logic 1", a "1" telegram on a gate input always causes a restart of the time delay. A "0" state on a gate output in "Transmission behaviour for logic 0" retriggers the switch-off delay each time. Consequently, input states are only evaluated and output states are transmitted to the bus as a telegram only once the time delays have elapsed completely.
- This should be observed particularly when input states are sent cyclically to the gate. For a combination of cyclic transmission and delays, the delay times must always be set smaller than the times for the cyclic transmission.
- In the parameter "Transmit output object(s) cyclically", set whether, and if yes, in which time interval the output object or output objects should be sent.

On the parameter page "Logic gate -> Logic gate X -> Inputs" (the following settings can be made for each of the max. 4 inputs)...

- In the parameter "Connection", define whether an internal or external input value should be assigned. If an "internal input value" should be selected for the input, select the value from the list of all internal 1-bit values.
- Define the "behaviour" of the input. A normal or inverted evaluation can be defined.

On the parameter page "Logic gate -> Logic gate X -> Outputs" (the following settings can be made for each of the possible outputs)...

- Set the parameter "Switching command for logic 0 / 1" for 1-bit outputs and "Value for logic 0 / 1" for 1-byte outputs.

The logic gate has been completely parameterised.

4.2.4.6 Delivery state

In the state as delivered, the application program is unloaded. After connecting the bus voltage, the programming LED will therefore start flashing at a fixed frequency of 0.5 Hz. The device does not react any further in this state. It transmits no telegrams to the bus. The physical address is preset to 15.15.255

The device has to be programmed and put into operation via the ETS .

4.2.5 Parameters

4.2.5.1 Parameter sensor

Description	Values	Comment
<input type="checkbox"/> Sensor <input type="checkbox"/> Sensor -> CO2 measurement		
Height of location above sea level (0...2000) * 1 m	0... 500 ...2000	The measured value of the CO ₂ sensor module is air pressure dependent. The parameter "Height of location above sea level" is provided in order to compensate for this dependency. The user can enter the current location height freely here.
Transmit on change of the measured value by (Transmission delay: 10 s)	inactive 0.5% 1% 3% 10%	So as not to burden the bus with very frequent telegrams, the measured value should not be sent for every tiny change. While taking the measurement task into account, a maximum possible value should be set here. The setting here refers to the measuring range of the CO ₂ measurement (here: 2000 ppm).
Cycl. sending of the measured value (0...120) * 10 s; 0 = inactive	0 ... 120	Here you can set whether and within which time interval the value is transmitted. The set value multiplied by 10 is the repeat time in seconds. It is thus possible to set the cycle time in steps of 10 seconds. The value "0" means that no cyclic sending is carried out.
Limiting values	Inactive 1 Limiting value active 2 Limiting values active 3 Limiting values active 4 Limiting values active	Here you can set whether and how many limiting values are activated for the CO ₂ measurement.
Behaviour of the limiting value 1 and 2 in frost/heat protection mode of the controller, Operating mode heating and operating mode cooling	No action send ON send OFF ON, no telegram OFF, no telegram	The values can be set separately according to heating operating mode, cooling operating mode for the limiting values 1 and 2. If the controller changes to the operating mode frost/heat protection, then the behaviour of the limiting values parameterised here is executed in frost/heat protection mode according to the operating mode of the controller.
		In the "no action" setting, the behaviour of all limiting values of the measured value is unaffected and they continue

working normally.

The "send ON" and "send OFF" settings set the limiting values of the measured value to the value ON or OFF and trigger an ON or OFF telegram of the limiting values to the bus.

If "ON, no telegram" or "OFF, no telegram" was configured, then only the object values of all limiting values of the measured value are set to the value ON or OFF. Telegrams are not triggered in this case.

No further evaluation of the limiting values takes place during the active frost/heat protection mode. The limiting values are first evaluated and updated again after changing to another operating mode (comfort, standby or night mode).

If the controller is in the frost/heat protection operating mode and the operating mode changes from heating to cooling or vice versa, then the parameterised behaviour of the limiting values is executed according to the current operating mode of the controller.

The cyclical transmission of the limiting values of the measured values is not influenced.

Behaviour of the limiting values 3 and 4 in frost/heat protection mode of the controller, Operating mode heating and operating mode cooling	No action send ON send OFF ON, no telegram OFF, no telegram
---	--

The values can be set separately according to heating operating mode, cooling operating mode for the limiting values 3 and 4.

If the controller changes to the operating mode frost/heat protection, then the behaviour of the limiting values parameterised here is executed in frost/heat protection mode according to the operating mode of the controller.

In the "no action" setting, the behaviour of all limiting values of the measured value is unaffected and they continue working normally.

The "send ON" and "send OFF" settings set the limiting values of the measured value to the value ON or OFF and trigger an ON or OFF telegram of the limiting values to the bus.

If "ON, no telegram" or "OFF, no telegram" was configured, then only the object values of all limiting values of the measured value are set to the value ON

or OFF. Telegrams are not triggered in this case.

No further evaluation of the limiting values takes place during the active frost/heat protection mode. The limiting values are first evaluated and updated again after changing to another operating mode (comfort, standby or night mode).

If the controller is in the frost/heat protection operating mode and the operating mode changes from heating to cooling or vice versa, then the parameterised behaviour of the limiting values is executed according to the current operating mode of the controller.

The cyclical transmission of the limiting values of the measured values is not influenced.

□-| Sensor -> CO2 measurement -> Limiting value x (x = 1...4)

Limiting value 1 to 4
(0..2000) * 1ppm

0...**400**...2000

The limiting value can be configured here.

Hysteresis
(0...50) * 1% related to
limiting value range

0...**5**...50

The hysteresis of the limiting value is defined by this parameter. The value set here refers to the limiting value measuring range (here: 2000 ppm).

External limiting value
1 to 4

No

Absolute value via 2-byte
object

Percentage via 1-byte
object

Save limiting value via
switching object (teaching)

With "No" no external limiting value is configured.

With "Absolute value via 2-byte object" the limiting value is predefined via a 2-byte value object.

With "Percentage via 1-byte object" the limiting value is predefined via a 1-byte value object.

When using the external switching object "Store limiting value via switching object", the current measured value of the sensor can be defined as limiting value.

Activation of limiting
value
1 to 4
(LV = Limiting value,
Hyst = Hysteresis)

**Exceed LV=ON,
undershoot LV
hysteresis=OFF'**

Exceed LV=OFF,
Undershoot LV-hyst.=ON

Undershoot LV=ON,
exceed LV-hyst.=OFF

Determines in which case the limiting values are activated.

Undershoot LV=OFF,
exceed LV-hyst.=ON

Exceed LV=ON,
undershoot LV-hyst.=no
telegram

Exceed LV=OFF,
Undershoot LV-hyst.=no
telegram

Undershoot LV=ON,
exceed LV-hyst.=no
telegram

Undershoot LV=OFF,
exceed LV-hyst.=no
telegram

Exceed LV-hyst.=no
telegram, undershoot LV-
hyst.=OFF

Exceed LV-hyst.=no
telegram, undershoot LV-
hyst.=ON

Undershoot LV-hyst.=no
telegram, exceed LV-
hyst.=OFF

Undershoot LV-hyst.=no
telegram, exceed LV-
hyst.=ON

Switch-on delay for
internal limiting value
object

none
1 sec
3 sec
5 sec
10 sec
15 sec
30 sec
1min
3 min
5 min
10 min
15 min
30 min
60 min

The state "1" of the limiting value is first transferred to the limiting value object after changing from "0" to "1" according to the time set here.

Switch-off delay for
internal limiting value
object

none
1 sec
3 sec
5 sec
10 sec
15 sec
30 sec
1min

The state "0" of the limiting value is first transferred to the limiting value object after changing from "1" to "0" according to the time set here.

	<p>3 min 5 min 10 min 15 min 30 min 60 min</p>	
<p>Transmission on change of the limiting value object</p>	<p>Yes No</p>	<p>With "No" the limiting value object is not transmitted following a change. With "Yes" the limiting value object is transmitted following a change from "0" to "1" or from "1" to "0".</p>
<p>Cyclical transmission of the limiting value object (0...120) * 10 s; 0 = inactive</p>	<p>0...120</p>	<p>Here you can set whether and within which time interval the limiting value is transmitted. The set value multiplied by 10 is the repeat time in seconds. It is thus possible to set the cycle time in steps of 10 seconds. The value "0" indicates that the limiting value object is not transmitted cyclically.</p>
<p><input type="checkbox"/> Sensor -> Temperature measurement</p>		
<p>Internal sensor calibration (-128...127) * 0.1 K</p>	<p>-128...0...127</p>	<p>Determines the value by which the room temperature measured value of the internal temperature sensor is calibrated. To ensure that an accurate value is constantly determined for the relative humidity, it is very important to also measure the exact temperature of the room air in addition to the humidity value. The determined room temperature value and calibrated room temperature value is also used for the humidity measurement at this point.</p>
<p>Transmit on change of the measured value by (Transmission delay: 10 s)</p>	<p>inactive 0.5% 1% 3% 10%</p>	<p>So as not to burden the bus with very frequent telegrams, the measured value should not be sent for every tiny change. While taking the measurement task into account, a maximum possible value should be set here.</p>
<p>Cycl. sending of the measured value (0...120) * 10 s; 0 = inactive</p>	<p>0...120</p>	<p>Here you can set whether and within which time interval the measured value is transmitted. The set value multiplied by 10 is the repeat time in seconds. It is thus possible to set the cycle time in steps of 10 seconds. The value "0" indicates that the measured value object is not transmitted cyclically.</p>

Temperature detection	Internal sensor received temperature value internal sensor + received temperature value	<p>The "Temperature detection" parameter specifies the sensors to detect the room temperature.</p> <p>Setting "internal sensor": the temperature sensor integrated in the room temperature controller is activated. Thus, the actual temperature value is determined only locally on the device. In this parameterisation the feedback control will start directly after a device reset.</p> <p>"Received temperature value" setting; Actual temperature is determined solely via a temperature value received from the bus. The sensor, in this case, can be a KNX room thermostat coupled via the 2-byte object "Received temperature". After a device reset the room temperature controller will first wait for a valid temperature telegram until the feedback control starts and a command value, if applicable, is output.</p> <p>Setting "internal sensor + received temperature value": In these settings, the selected temperature sources are combined together. The sensors can either be the integrated temperature sensor or a KNX room thermostat coupled via the 2-byte object "Received temperature". After a device reset the room temperature controller will first wait for a valid temperature telegram until the feedback control starts and a command value, if applicable, is output.</p>
Measured value formation, temperature value to be received internally	10% to 90% 20% to 80% 30% to 70% 40% to 60% 50% to 50% 60% to 40% 70% to 30% 80% to 20% 90% to 10%	<p>The weighting of the measured temperature value for the internal sensor and the temperature value received from the bus is specified here. That results in an overall value, which will be used for the further interpretation of the room temperature.</p> <p>This parameter is only visible with "temperature recording = internal sensor + received temperature value!"</p>
Calibration of received temperature value (-128...127) * 0.1 K	-128... 0 ...127	<p>Determines the value by which the temperature value received from the bus is calibrated.</p> <p>This parameter is only visible when the temperature recording system requires that a temperature value is received.</p>

Request time for received temperature value (0...255) * 1 min; 0 = inactive	0...255	The request time for the temperature value received from the bus is specified here. In the "0" setting, the temperature value is not automatically polled by the controller. In this case the communication partner (e.g. controller extension) must transmit its temperature value itself. This parameter is only visible when the temperature recording system requires that a temperature value is received.
Transmission when room temperature change by (0...255) * 0,1 K; 0 = inactive	0...3...255	Determines the size of the value change of the room temperature after which the current values are automatically transmitted on the bus via the "Actual temperature" object.
Cyclical transmission of room temperature (0...255) * 1 min; 0 = inactive	0...15...255	This parameter specifies whether and when the determined room temperature is to be periodically output via the "Actual temperature" object.
<input type="checkbox"/> Sensor -> humidity measurement		
Transmit on change of the measured value by (Transmission delay: 10 s)	inactive 0.5% 1% 3% 10%	So as not to burden the bus with very frequent telegrams, the measured value should not be sent for every tiny change. While taking the measurement task into account, a maximum possible value should be set here. The setting here refers to the measuring range of the humidity measurement (here: 100% RH).
Cycl. sending of the measured value (0...120) * 10 s; 0 = inactive	0...120	Here you can set whether and within which time interval the value is transmitted. The set value multiplied by 10 is the repeat time in seconds. It is thus possible to set the cycle time in steps of 10 seconds. The value "0" means that no cyclic sending is carried out.
Limiting values	Inactive 1 Limiting value active 2 Limiting values active	Here you can set whether and how many limiting values are activated for the humidity measurement.
Behaviour of the limiting values in frost/heat protection mode of the controller, Operating mode heating	No action send ON send OFF ON, no telegram	If the controller changes to the operating mode frost/heat protection, then the behaviour of the limiting values parameterised here is executed in frost/heat protection mode according to

and operating mode cooling	OFF, no telegram	<p>the operating mode of the controller.</p> <p>In the "no action" setting, the behaviour of all limiting values of the measured value is unaffected and they continue working normally.</p> <p>The "send ON" and "send OFF" settings set the limiting values of the measured value to the value ON or OFF and trigger an ON or OFF telegram of the limiting values to the bus.</p> <p>If "ON, no telegram" or "OFF, no telegram" was configured, then only the object values of all limiting values of the measured value are set to the value ON or OFF. Telegrams are not triggered in this case.</p> <p>No further evaluation of the limiting values takes place during the active frost/heat protection mode. The limiting values are first evaluated and updated again after changing to another operating mode (comfort, standby or night mode).</p> <p>If the controller is in the frost/heat protection operating mode and the operating mode changes from heating to cooling or vice versa, then the parameterised behaviour of the limiting values is executed according to the current operating mode of the controller.</p> <p>The cyclical transmission of the limiting values of the measured values is not influenced.</p>
<p>□- Sensor -> Humidity measurement -> Limiting value x (x = 1...2)</p>		
Limiting value 1 or 2 (20...100) * 1%RH	20... 60 ...100	The limiting value can be configured here.
Hysteresis (0...50) * 1%RH	0... 3 ...50	The hysteresis of the limiting value is defined by this parameter. The value set here refers to the limiting value measuring range (here: 100%RH).
External limiting value 1 or 2	<p>No</p> <p>Absolute value via 2-byte object</p> <p>Percentage via 1-byte object</p>	<p>With "No" no external limiting value 1 is configured.</p> <p>With "Absolute value via 2-byte object" the limiting value is predefined via a 2-byte value object.</p> <p>With "Percentage via 1-byte object" the limiting value is predefined via a 1-byte value object.</p>

	Save limiting value via switching object (teaching)	When using the external switching object "Store limiting value via switching object", the current measured value of the sensor can be defined as limiting value, e.g. by .button-press.
Activation of limiting value 1 or 2 (LV = Limiting value, Hyst = Hysteresis)	<p>Exceed LV=ON, undershoot LV hysteresis=OFF'</p> <p>Exceed LV=OFF, Undershoot LV-hyst.=ON</p> <p>Undershoot LV=ON, exceed LV-hyst.=OFF</p> <p>Undershoot LV=OFF, exceed LV-hyst.=ON</p> <p>Exceed LV=ON, undershoot LV-hyst.=no telegram</p> <p>Exceed LV=OFF, Undershoot LV-hyst.=no telegram</p> <p>Undershoot LV=ON, exceed LV-hyst.=no telegram</p> <p>Undershoot LV=OFF, exceed LV-hyst.=no telegram</p> <p>Exceed LV-hyst.=no telegram, undershoot LV-hyst.=OFF</p> <p>Exceed LV-hyst.=no telegram, undershoot LV-hyst.=ON</p> <p>Undershoot LV-hyst.=no telegram, exceed LV-hyst.=OFF</p> <p>Undershoot LV-hyst.=no telegram, exceed LV-hyst.=ON</p>	Determines in which case the limiting values are activated.
Switch-on delay for internal limiting value object	<p>none</p> <p>1 sec</p> <p>3 sec</p> <p>5 sec</p> <p>10 sec</p> <p>15 sec</p> <p>30 sec</p> <p>1min</p>	The state "1" of the limiting value is first transferred to the limiting value object after changing from "0" to "1" according to the time set here.

	<p>3 min 5 min 10 min 15 min 30 min 60 min</p>	
Switch-off delay for internal limiting value object	<p>none 1 sec 3 sec 5 sec 10 sec 15 sec 30 sec 1min 3 min 5 min 10 min 15 min 30 min 60 min</p>	The state "0" of the limiting value is first transferred to the limiting value object after changing from "1" to "0" according to the time set here.
Transmission on change of the limiting value object	<p>Yes No</p>	With "No" the limiting value object is not transmitted following a change. With "Yes" the limiting value object is transmitted following a change from "0" to "1" or from "1" to "0".
Cyclical transmission of the limiting value object (0...120) * 10 s; 0 = inactive	0...120	Here you can set whether and within which time interval the limiting value is transmitted. The set value multiplied by 10 is the repeat time in seconds. It is thus possible to set the cycle time in steps of 10 seconds. The value "0" indicates that the limiting value object is not transmitted cyclically.
<input type="checkbox"/> Sensor -> Dew point		
Transmit on dew point change by (Transmission delay: 10 s)	<p>inactive 0.5% 1% 3% 10%</p>	So as not to burden the bus with very frequent telegrams, the measured value should not be sent for every tiny change. While taking the measurement task into account, a maximum possible value should be set here. The setting here refers to the measuring range of the temperature measurement of the dew point alarm (-30 °C ... +70 °C -> 100 °C).
Cyclic transmission of the dew point temperature (0...120) * 10 s; 0 = inactive	0...120	Here you can set whether and within which time interval the dew point temperature calculated by the device is transmitted. The set value multiplied by 10 is the repeat time in seconds. It is

		thus possible to set the cycle time in steps of 10 seconds. The value "0" indicates that the temperature value is not transmitted cyclically.
Lead dew point alarm (0...5) * 1K	0... 2 ...5	The alarm threshold is defined here before reaching the dew point temperature.
Switch-off hysteresis (0...5) * 1K	0... 1 ...5	The alarm hysteresis is defined here, i.e., starting from the alarm threshold set, how many Kelvin the temperature must decrease by before the alarm is stopped.
Number and type of alarm objects	1 switching object 1 value object 2 switching objects 2 value objects 1 switching object and 1 value object	Determines the type and number of configured alarm objects.
Switching command for dew point alarm	ON OFF	This parameter defines the command that should be output during dew point alarm. Only when "Type of alarm objects" = switching object"
Value for dew point alarm active (0...100) * 1%	0... 100	This parameter defines which value should be output during an active dew point alarm.
Value for dew point alarm inactive (0...100) * 1%	0 ...100	This parameter defines which value should be output during an inactive dew point alarm.

4.2.5.2 Room temperature controller parameter

Description	Values	Comment
□ Room temperature control -> Controller general		
Operating mode	<p>Heating</p> <p>Cooling</p> <p>Heating and cooling</p> <p>Basic and additional heating</p> <p>Basic and additional cooling</p> <p>Basic and additional heating and cooling</p>	<p>The room temperature controller distinguishes between two different operating modes. The operating modes specify whether you want the controller to use its variable to trigger heating systems ("heating" single operating mode) or cooling systems ("cooling" single operating mode). You can also activate mixed operation, with the controller being capable of changing over between "Heating" and "Cooling" either automatically or, alternatively, controlled by a communication object. In addition, you can establish two-level control operation to control an additional heating or cooling unit. For two-level feedback control, separate command values will be calculated as a function of the temperature deviation between the setpoint and the actual value and transmitted to the bus for the basic and additional levels.</p> <p>This parameter specifies the operating mode and, if necessary, enables the additional level(s).</p>
Additional level disabling object	<p>Yes</p> <p>No</p>	<p>The additional levels can be separately disabled via the bus. The parameter enables the disable object as necessary. This parameter is only visible in two-level heating and cooling operation.</p>
Transmit heating and cooling command values to one common object	<p>Yes</p> <p>No</p>	<p>If the parameter is set to "Yes", the command value will be transmitted on a shared object during heating or cooling. This function is used, if the same heating system is used to cool the room in the summer and used to heat the room in the winter.</p> <p>This parameter is only visible with "heating and cooling" mixed operating mode, if applicable, with additional levels.</p>
Type of heating control (if applicable, for basic and additional level)	<p>Continuous PI control</p> <p>Switching PI control (PWM)</p> <p>Switching 2-point feedback control (ON/OFF)</p>	<p>Selecting a feedback control algorithm (PI or 2-point) with data format (1 byte or 1 bit) for the heating system.</p>

Type of heating (if applicable, for basic and additional level)	Hot water heater (5 K / 150 min) Underfloor heating (5 K / 240 min) Electric heating (4 K / 100 min) Fan convector (4 K / 90 min) Split unit (4 K / 90 min) via control parameter	Adapting the PI algorithm to different heating systems using predefined values for the proportional range and reset time control parameters. With the "Using control parameters" setting, it is possible to set the control parameters in a manner deviating from the predefined values within specific limits. This parameter is only visible if "Type of heating control = Continuous PI control".
Proportional range heating (10 ... 127) * 0.1 K	10... 50 ...127	Separate setting of the "Proportional range" control parameter. This parameter is only visible if "Type of heating = via control parameter" and the heating control type "PI control".
Reset time heating (0 ... 255) * 1 min; 0 = inactive	0... 150 ...255	Separate setting of the "Reset time" control parameter. This parameter is only visible if "Type of heating = via control parameter" and the heating control type "PI control".
Top hysteresis of the 2-point controlling heating (5 ... 127) * 0.1 K	5 ...127	Definition of top hysteresis (switch-off temperatures) of the heating. This parameter is only visible if "Type of heating control = Switching 2-point feedback control (ON/OFF)".
Bottom hysteresis of the 2-point controlling heating (-128 ... -5) * 0.1 K	-128... -5	Definition of bottom hysteresis (switch-on temperatures) of the heating. This parameter is only visible if "Type of heating control = Switching 2-point feedback control (ON/OFF)".
Type of cooling control (if applicable, for basic and additional level)	Continuous PI control Switching PI control (PWM) Switching 2-point feedback control (ON/OFF)	Selecting a feedback control algorithm (PI or 2-point) with data format (1 byte or 1 bit) for the cooling system.
Type of cooling (if applicable, for basic and additional level)	Cooling ceiling (5 K / 240 min) Fan convector	Adapting the PI algorithm to different cooling systems using predefined values for the proportional range and reset time control parameters.

	(4 K / 90 min) Split unit (4 K / 90 min) via control parameter	With the "Using control parameters" setting, it is possible to set the control parameters in a manner deviating from the predefined values within specific limits. This parameter is only visible if "Type of cooling control = PI control".
Proportional range cooling (10 ... 127) * 0.1 K	10... 50 ...127	Separate setting of the "Proportional range" control parameter. This parameter is only visible if "Type of cooling = via control parameter" and the cooling control type "PI control".
Reset time cooling (0 ... 255) * 1 min; 0 = inactive	0... 240 ...255	Separate setting of the "Reset time" control parameter. This parameter is only visible if "Type of cooling = via control parameter" and the cooling control type "PI control".
Top hysteresis of the 2-point controlling cooling (5 ... 127) * 0.1 K	5 ...127	Definition of top hysteresis (switch-on temperatures) of the cooling. This parameter is only visible if "Type of cooling control = Switching 2-point feedback control (ON/OFF)".
Bottom hysteresis of the 2-point controlling cooling (-128 ... -5) * 0.1 K	-128... -5	Definition of bottom hysteresis (switch-off temperatures) of the cooling. This parameter is only visible if "Type of cooling control = Switching 2-point feedback control (ON/OFF)".
Operating mode switch-over	via value (1 byte) via switching (4 x 1 bit)	In the setting "Via value (1-byte) the change-over of the operating modes via the bus takes place according to the KNX specification via a 1-byte value object. In addition, a higher-ranking forced-object is available for this setting. In the setting "Via switching (4 x 1 bit)" the 'classic' change-over of the operating modes via the bus is via four separate 1-bit objects.
Operation mode after reset	Restore operation mode before reset Comfort mode Standby mode Night operation Frost/heat protection mode	This parameter specifies which operating mode is set immediately after a device reset. With "Restore operation mode before reset": The mode set before a reset according to the operating mode object will be restored after the initializing phase of the device. Operating modes set by a function with a higher priority before the reset (Forced, Window

		status, Presence status) are not effected. Frequent changing of the operating mode (e. g. several times a day) during running operation can adversely affect the life of the device as the read-only memory (EEPROM) used has been designed for less frequent write access events only.
Frost/heat protection	Automatic frost protection via window status	Here it is possible to determine how the room temperature regulator switches into the frost/heat protection. With "automatic frost protection": the automatic frost protection is activated. Depending on the room temperature this allows an automatic switch-over into the frost protection mode. With "Via window status": switch-over into the frost/heat protection takes place via the "window status" object.
Automatic frost protection temperature drop	Off 0.2 K / min. 0.3 K / min. 0.4 K / min. 0.5 K / min. 0.6 K / min.	This parameter determines the decrease temperature by which the room temperature has to decrease within one minute in order for the controller to switch into the frost protection mode. The "OFF" setting will deactivate the frost protection automatic. Only visible if "frost/heat protection = Automatic frost protection"!
Frost protection period in automatic mode (1...255) * 1 min	1... 20 ...255	The length of the automatic frost protection is defined here. After the preset time has elapsed, the controller will return to the operating mode which was set before frost protection. Re-triggering will not be possible. Only visible if "frost/heat protection = Automatic frost protection"!
Window status delay (0...255) * 1 min.; 0 = inactive	0 ...255	This parameter defines the delay time for the window status. After the parameterised time has elapsed after the window is opened the window status will be changed and thus the frost/heat protection mode activated. Such delay can make sense if short ventilation of the room by opening the window is not supposed to change the operating mode. Only visible if "Frost/heat protection = via window status"!

☐ ↩ Room temperature control -> Controller general -> Command value and status output

Automatic transmission at modification by (0...100) * 1 %; 0 = inactive	0... 3 ...100	This parameter determines the size of the command value change that will automatically transmit continuous command value telegrams via the command value objects. Thus this parameter only affects command values which are configured to "Continuous PI control" and to the 1 byte additional command value objects of the "Switching PI control (PWM)".
Cycle time of the switching command value (1...255) * 1 min	1... 15 ...255	This parameter specifies the cycle time for the pulse width modulated command value (PWM). Thus this parameter only affects command values which are configured to "Switching PI control (PWM)".
Cycle time for automatic transmission (0...255) * 1 min; 0 = inactive	0... 10 ...255	This parameter determines the time interval for the cyclical transmission of the command values via all command value objects.
Output of the heating command value	Inverted (under current, this means closed) Normal (under current, this means opened)	At this point, it is possible to specify whether the command value telegram for heating is output normally or in inverted form. This parameter is only visible if the operating mode "Heating" or "Heating and cooling" is configured and not two-level operation.
Output of the heating basic level command value	Inverted (under current, this means closed) Normal (under current, this means opened)	At this point, it is possible to specify whether the command value telegram for the heating basic level is output normally or in inverted form. This parameter is only visible if the operating mode "Heating" or "Heating and cooling" is configured along with two-level operation.
Output of the heating additional level command value	Inverted (under current, this means closed) Normal (under current, this means opened)	At this point, it is possible to specify whether the command value telegram for the heating additional level is output normally or in inverted form. This parameter is only visible if the operating mode "Heating" or "Heating and cooling" is configured along with two-level operation.
Output of the cooling command value	Inverted (under current, this means closed)	At this point, it is possible to specify whether the command value telegram for cooling is output normally or in

	Normal (under current, this means opened)	inverted form. This parameter is only visible if the operating mode "Cooling" or "Heating and cooling" is configured and not two-level operation.
Output of the cooling basic level command value	Inverted (under current, this means closed) Normal (under current, this means opened)	At this point, it is possible to specify whether the command value telegram for the cooling basic level is output normally or in inverted form. This parameter is only visible if the operating mode "Cooling" or "Heating and cooling" is configured along with two-level operation.
Output of the cooling additional level command value	Inverted (under current, this means closed) Normal (under current, this means opened)	At this point, it is possible to specify whether the command value telegram for the cooling additional level is output normally or in inverted form. This parameter is only visible if the operating mode "Cooling" or "Heating and cooling" is configured along with two-level operation.
Command value limit	deactivated continuously activated can be activated via object	The command value limit allows the restriction of calculated command values to the range limits "minimum" and "maximum". The limits are permanently set in the ETS and, if command value limitation is active, can be neither undershot or exceeded during device operation. The "Command value limit" parameter defines the mode of action of the limiting function. The command value limit can either be activated or deactivated using the 1-bit communication object "Command value limit", or be permanently active.
Command value limit after reset	deactivated activated	When controlling via the object, it is possible to have the controller activate the command value limit automatically after bus voltage return or an ETS programming operation. This parameter defines the initialisation behaviour here. In the "Deactivated" setting, the command value limit is not automatically activated after a device reset. A "1" telegram must first be received via the "Command value limit" object for the limit to be activated. In the "Activated" setting, the controller activates the command value limit automatically after a device reset. To deactivate the limit a "0" telegram must

		be received via the "Command value limit" object. The limit can be switched on or off at any time using the object. This parameter is only visible with "Command value limit = can be activated via object"!
Minimum command value for heating (optionally also for basic and additional level)	5% , 10%, 15%, 20%, 25%, 30%, 35%, 40%, 45%, 50%	The "Minimum command value" parameter specifies the lower command value limiting value for heating. With an active command value limit, the set minimum command value is not undershot by command values. If the controller calculates smaller command values, it sets the configured minimum command value. The controller transmits a 0 % command value if no more heating or cooling energy has to be demanded.
Maximum command value for heating (optionally also for basic and additional level)	55%, 60%, 65%, 70%, 75%, 80%, 85%, 90%, 95% , 100%	The "Maximum command value" parameter specifies the upper command value limiting value for heating. With an active command value limit, the set maximum command value is not exceeded. If the controller calculates larger command values, it sets the configured maximum command value.
Minimum command value for cooling (optionally control circuit 1) (optionally also for basic and additional level)	5% , 10%, 15%, 20%, 25%, 30%, 35%, 40%, 45%, 50%	The "Minimum command value" parameter specifies the lower command value limiting value for cooling. With an active command value limit, the set minimum command value is not undershot by command values. If the controller calculates smaller command values, it sets the configured minimum command value. The controller transmits a 0 % command value if no more heating or cooling energy has to be demanded.
Maximum command value for cooling (optionally also for basic and additional level)	55%, 60%, 65%, 70%, 75%, 80%, 85%, 90%, 95% , 100%	The "Maximum command value" parameter specifies the upper command value limiting value for cooling. With an active command value limit, the set maximum command value is not exceeded. If the controller calculates larger command values, it sets the configured maximum command value.
Heating message	Yes No	Depending on the set operating mode, a separate object can be used to signal whether the controller is currently

		demanding heating energy and is thus actively heating. The "Yes" setting here enables the message function for heating.
Cooling message	Yes No	Depending on the set operating mode, a separate object can be used to signal whether the controller is currently demanding cooling energy and is thus actively cooling. The "Yes" setting here enables the message function for cooling.
Controller status	no status KNX compliant Controller general transmit individual state	The room temperature controller can transmit its current status to the KNX/EIB. A choice of data formats is available for this. This parameter enables the status signal and sets the status format.
Single status	Comfort mode activated Standby mode activated Night mode activated Frost/heat protection active Controller disabled Heating / cooling Controller inactive Frost alarm	Here, the status information is defined, which is to be transmitted onto the bus as the 1-bit controller status. This parameter is only visible if the parameter "Controller status" is set to "Transmit single status".
Behaviour when command value = 100% (Clipping mode PI control)	keep 100% until setpoint = actual, then 0% keep 100% as required, then adjust downwards	If with a PI control the calculated command value of the controller exceeds the physical limits of the actuator, in other words if the calculated command value is greater than 100%, then the command value is set to the maximum value (100%) and thus limited. With PI control the command value can reach the value "100%" if there is a large deviation of the room temperature from the setpoint temperature or the controller requires a long time to adjust to the setpoint with the heating or cooling energy that is being applied. The controller can evaluate this state in a particular manner and react to it in various ways. This

parameter defines the functions of the PI controller when the command value is 100%.

"keep 100% until setpoint = actual, then 0%" setting:

The controller keeps the maximum command value until the room temperature (actual value) reaches the setpoint temperature. After that it reduces the command value down to 0% all at once (controller reset). The advantage of this control behaviour is that in this way sustainable heating up of undercooled rooms or effective cooling of overheated rooms will be achieved by overshooting the setpoint. The disadvantage is that in some circumstances the overshooting of the room temperature may be found disturbing.

Setting "keep 100% as required, then adjust downwards":

The controller maintains the maximum command value only as long as it is necessary. After that it adjusts the command value downwards according to the PI algorithm. The advantage of this control characteristic is the fact that the room temperature does not exceed the setpoint temperature at all, or only slightly. The disadvantage is that this control principle increases the tendency to oscillate about the setpoint.

□-| Room temperature control -> Controller general -> Setpoints

Overwrite setpoints in
device after ETS
programming
operation? **Yes**
No

The temperature setpoints programmed in the room temperature controller by the ETS during commissioning can be changed via communication objects. This parameter can be used to define whether the setpoints present in the device, which may have been changed subsequently, are overwritten during an ETS programming operation and thus replaced again by the values parameterised in the ETS. If this parameter is on "Yes", then the temperature setpoints are deleted in the device during a programming operation and replaced by the values of the ETS. If this parameter is configured to "No", then setpoints present in the device remain unchanged. The setpoint temperatures entered in the ETS then have no significance.

Setpoint presetting

	<p>relative (setpoint temperatures from basic setpoint)</p>	<p>It is possible to configure the setpoints for the "Comfort", "Standby" and "Night" modes directly (absolute setpoint presetting) or relatively (derivation from basic setpoint). This parameter defines the way the setpoint temperature is preset. With "Relative": All temperature setpoints are derived from the basic temperature (basic setpoint). With "Absolute": The setpoint temperatures are independent of each other. Different temperature values can be specified for each operating mode and heating/cooling mode.</p>
<p>absolute (independent setpoint temperatures)</p>		
<p>Basic temperature after reset (7.0 ... 40.0) * 1°C</p>	<p>7.0...21.0...40.0</p>	<p>This parameter defines the temperature value to be applied as the basic setpoint after commissioning by the ETS. All the temperature setpoints are derived from the basic setpoint. This parameter is only visible with relative setpoint presetting!</p>
<p>Value of the setpoint shift</p>	<p>0.1 K 0.5 K</p>	<p>In addition to presetting individual temperature setpoints by the ETS or basic setpoint object, the user, when presetting relative setpoints, can shift the basic setpoint in predefined limits within a specific range. When doing so, the basic setpoint is adjusted up or down in levels. The value of a level can be adjusted here to 0.1 K or 0.5 K.</p>
<p>Accept change of the basic setpoint shift permanently</p>	<p>No Yes</p>	<p>In addition to presetting individual temperature setpoints by the ETS or basic setpoint object, the user can shift the basic setpoint in a specific range to predefined limits. Whether a basic setpoint shifting only affects the currently active operating mode or whether it influences all other setpoint temperatures of the remaining operating modes is determined by this parameter. In the "Yes" setting, the shift of the basic setpoint carried out affects all operating modes. The shifting is maintained even after change-over of the operating mode or the heating/cooling mode or readjusting the basic setpoint. In the "No" setting, the basic setpoint shift carried out is in effect for only as long as the operating mode or heating/cooling mode has not changed or the basic setpoint is maintained. Otherwise the setpoint shift will be reset to "0".</p>

		This parameter is only visible with relative setpoint presetting!
Modification of the basic temperature setpoint value	deactivated approve via bus	Here, it is possible to specify if it is possible to change the basic setpoint via the bus. This parameter is only visible with relative setpoint presetting!
Accept modification of the basic temperature setpoint value permanently	No Yes	One has to distinguish between two cases, defined by this parameter, if the basic setpoint has been modified via the object. This parameter is only visible with relative setpoint presetting! When set to "Yes": If, with this setting, the temperature setpoint is adjusted, the controller saves the value permanently to the EEPROM (permanent storage). The newly adjusted value will overwrite the initial value, i.e. the basic temperature originally configured via the ETS after a reset! The changed values are also retained after a device reset, after a switch-over of the operating mode or after a switch-over of the heating/cooling mode. With this setting, it should be noted that frequent changing of the basic temperature (e.g. several times a day because of cyclical telegrams) can affect the product life of the device as the non-volatile storage is designed for less frequent write access. When set to "No": The setpoints received via the objects remain active only temporarily. In case of a bus voltage failure or following a switch-over to another operating mode (e.g. Comfort followed by Standby, or also Comfort followed by Comfort), or after a switch-over of the heating/cooling mode (e.g. heating after cooling), the last setpoint changed will be discarded and replaced by the initial value.
Accept modification of the setpoint permanently?	No Yes	One has to distinguish between two cases, defined by this parameter, if the setpoint has been modified via the object. This parameter is only visible with absolute setpoint presetting! When set to "Yes": If, with this setting, the temperature setpoint is adjusted, the controller saves the value permanently

to the EEPROM (permanent storage). The newly adjusted value will overwrite the initial value, i.e. the absolute setpoint temperature originally loaded using the ETS. The changed values are also retained after a device reset, after a switch-over of the operating mode or after a switch-over of the heating/cooling mode (with absolute setpoint presetting individually for each operating mode for heating and cooling).

With this setting, it should be noted that frequent changing of the basic temperature (e.g. several times a day because of cyclical telegrams) can affect the product life of the device as the non-volatile storage is designed for less frequent write access.

When set to "No": The setpoints received via the objects remain active only temporarily. In case of a bus voltage failure or following a switch-over to another operating mode (e.g. Comfort followed by Standby, or also Comfort followed by Comfort), or after a switch-over of the heating/cooling mode (e.g. heating after cooling), the last setpoint changed will be discarded and replaced by the initial value.

Setpoint temp. comfort mode (heating) 7.0...**21.0**...40.0
(7.0 °C...40.0 °C) * 1°C

With absolute setpoint presetting the setpoint temperatures for comfort, standby and night mode are independent of each other. Depending on the operating mode and heating/cooling mode, various temperature values can be specified in the ETS within the range +7.0 °C to +40.0 °C. The ETS plug-in does not validate the temperature values. It is thus possible, for example, to select smaller setpoint temperatures for cooling mode than for heating mode, or to specify lower temperatures for comfort mode than for standby mode. After commissioning using the ETS the setpoint temperatures can be changed via the bus by means of temperature telegrams. This can be done using the communication object "Setpoint active operating mode".

Presetting of the setpoint temperature for the comfort heating mode. These parameters are only visible with absolute setpoint presetting!

Setpoint temp. standby mode (heating) 7.0...**19.0**..40.0
(7.0 °C...40.0 °C) * 1°C

Presetting of the setpoint temperature for standby mode (heating).

Setpoint temp. night mode (heating) (7.0 °C...40.0 °C) * 1°C	7.0... 17.0 ...40.0	Presetting of the setpoint temperature for night mode (heating).
Setpoint temp. comfort mode (cooling) (7.0 °C...40.0 °C) * 1°C	7.0... 23.0 ...40.0	Presetting of the setpoint temperature for the comfort cooling mode.
Setpoint temp. standby mode (cooling) (7.0 °C...40.0 °C) * 1°C	7.0... 25.0 ...40.0	Presetting of the setpoint temperature for standby mode (cooling).
Setpoint temp. night mode (cooling) (7.0 °C...40.0 °C) * 1°C	7.0... 27.0 ...40.0	Presetting of the setpoint temperature for night mode (cooling).
Frost protection setpoint temperature (7.0...40.0) * 1°C	7.0 ...40.0	This parameter specifies the setpoint temperature for frost protection. The parameter is only visible in "Heating" or "Heating and cooling" operating modes (if necessary with additional levels).
Heat protection setpoint temperature (7.0...45.0) * 1°C	7.0... 35.0 ...45.0	This parameter specifies the setpoint temperature for heat protection. The parameter is only visible in "Cooling" or "Heating and cooling" operating modes (if necessary with additional levels).
Deadband position	symmetrical asymmetrical	<p>With relative setpoint presetting, the comfort setpoint temperatures for the operating mode "Heating and cooling" are derived from the basic setpoint in consideration of the adjusted Dead band. The deadband (temperature zone for which there is neither heating nor cooling) is the difference between the comfort setpoint temperatures.</p> <p>Symmetrical setting: the deadband preset in the ETS plug-in is divided in two parts at the basic setpoint. The comfort setpoint temperatures are derived directly from the basic setpoint resulting from the half deadband (Basic setpoint - 1/2 deadband = Heating comfort temperature or Basic setpoint + 1/2 deadband = Cooling comfort temperature).</p> <p>Asymmetrical setting: with this setting the comfort setpoint temperature for heating equals the basic setpoint! The preset deadband is effective only from</p>

		<p>the basic setpoint in the direction of comfort temperature for cooling. Thus the comfort set-temperature for cooling is derived directly from the comfort setpoint for heating.</p> <p>The parameter is only visible in the "Heating and cooling" operating mode (if necessary with additional levels) and only with relative setpoint presetting!</p>
Deadband between heating and cooling (0...127) * 0.1 K	0... 20 ...127	<p>With relative setpoint presetting, the comfort setpoint temperatures for heating and cooling are derived from the basic setpoint in consideration of the adjusted Dead band. The deadband (temperature zone for which there is neither heating nor cooling) is the difference between the comfort setpoint temperatures. It is set using this parameter.</p> <p>The parameter is only visible in the "Heating and cooling" operating mode (if necessary with additional levels) and only with relative setpoint presetting.</p>
Difference between basic and additional levels (0...127) * 0.1 K	0... 20 ...127	<p>In a two-level control mode, it is necessary to determine the temperature difference to the basic level with which the additional level is to be incorporated into the feedback control. This parameter defines the level spacing.</p> <p>The parameter can only be seen in two-level control operation.</p>
Transmission at setpoint temperature change by (0...255) * 0.1 K; 0 = inactive	0... 1 ...255	<p>Determines the size of the value change required to automatically transmit the current value via the "Setpoint temperature" object. In the "0" setting, the setpoint temperature is not transmitted automatically when there is a change.</p>
Cyclical transmission of setpoint temperature (0...255) * 1 min; 0 = inactive	0 ...255	<p>This parameter determines whether the setpoint temperature is to be transmitted periodically via the "Setpoint temperature" object. Definition of the cycle time by this parameter In the "0" setting, the setpoint temperature is not transmitted automatically cyclically.</p>

Upward adjustment of the basic setpoint temperature (0...10) * 1 K	0 K + 1 K + 2 K + 3 K + 4 K + 5 K + 8 K + 9 K + 10 K	This is used to define the maximum range in which the basic setpoint temperature can be adjusted upwards. This parameter is only visible with relative setpoint presetting!
Downward adjustment of the basic setpoint temperature (0...10) * 1 K	0 K - 1 K - 2 K - 3 K - 4 K - 5 K - 8 K - 9 K - 10 K	This is used to define the maximum range in which the basic setpoint temperature can be adjusted downwards. This parameter is only visible with relative setpoint presetting!
Lower the setpoint temperature during standby operation (heating) (-128...0) * 0.1 K	-128... -20 ...0	The value by which the standby setpoint temperature for heating is lowered compared to the heating comfort temperature. The parameter is only visible in the "Heating" or "Heating and cooling" operating mode (if necessary with additional levels) and only with relative setpoint presetting.
Lower the setpoint temperature during night operation (heating) (-128...0) * 0.1 K	-128... -40 ...0	The value by which the night setpoint temperature for heating is lowered compared to the heating comfort temperature. The parameter is only visible in the "Heating" or "Heating and cooling" operating mode (if necessary with additional levels) and only with relative setpoint presetting.
Raise the setpoint temperature during standby operation (cooling) (-128...127) * 0.1 K	0... 20 ...127	The value by which the standby setpoint temperature for cooling is lowered compared to the cooling comfort temperature. The parameter is only visible in the "Heating" or "Heating and cooling" operating mode (if necessary with additional levels) and only with relative setpoint presetting.
Raise the setpoint temperature during night operation (cooling) (-128...127) * 0.1 K	0... 40 ...127	The value by which the night temperature for cooling is lowered compared to the cooling comfort temperature.

		The parameter is only visible in the "Heating" or "Heating and cooling" operating mode (if necessary with additional levels) and only with relative setpoint presetting.
Change-over between heating and cooling	automatic via object (heating/cooling change-over)	In a configured mixed mode it is possible to switch over between heating and cooling. With "Automatic": Depending on the operating mode and the room temperature, the change-over takes place automatically. With "Via object (heating/cooling change-over)": The change-over takes place only via the object "Heating / cooling change-over". With automatic setpoint presetting this parameter is permanently set to "Via object (heating/cooling switch-over)"!
Heating / cooling operating mode after reset	Heating Cooling Operating mode before reset	The preset operating mode for after the return of the bus voltage is specified here. Only visible if "Change-over between heating and cooling = via object"!
Automatic heating/cooling switch-over transmission	on changing the operating mode on changing the output value	Here, it is possible to specify when a telegram is transmitted automatically onto the bus via the object "Heating / cooling change-over". Only visible if "Change-over between heating and cooling = automatic".
Cyclical transmission heating/cooling change-over (0...255) * 1 min; 0 = inactive	0...255	This parameter specifies whether the current object status of the "Heating / cooling change-over" object should be output cyclically to the bus on an automatic change-over. The cycle time can be set here. The "0" setting will deactivate the periodic transmission of the object value. Only visible if "Change-over between heating and cooling = automatic".
<input type="checkbox"/> Room temperature measurement -> Controller functionality		
Presence detection	none Presence button Motion detector	In the "None" setting, the presence mode is deactivated. In the "Presence button" setting, presence detection takes place via the presence object (e.g. other push button sensors). When the presence button is pressed from the night mode or frost/heat protection, the comfort

		<p>extension is activated. If the presence button is pressing in standby mode, the controller activates the comfort mode for the duration of the presence mode. In the "Motion detector" setting, presence detection takes place using an external motion detector, coupled to the presence object. Comfort mode is recalled when a presence is detected. Comfort mode remains active until the motion detector ceases to detect movement. In this setting, a presence button on the device has no function.</p>
Length of the comfort extension (0...255) * 1 min; 0 = OFF	0... 30 ...255	<p>When the presence button is pressed from the Night mode or Frost/heat protection, the controller switches to Comfort mode for the length of time specified here. When this time has elapsed, it switches back automatically. In the "0" setting, the comfort extension is switched off, meaning that it cannot be activated from Night or Frost/heat protection mode. In this case, the operating mode will not be changed, although the presence function has been activated. This parameter is only visible when presence detection is configured to "Presence button".</p>
Switch off controller (dew point operation)	No Via bus	<p>This parameter enables the "Disable controller" object. If the controller is disabled, there is no feedback control until enabled (command values = 0).</p>
Valve protection	No Yes	<p>Valve protection may be carried out periodically in order to prevent the addressed control valves of the heater or cooling system from becoming calcified or stuck. The "Yes" setting in this parameter activates valve protection. This type of protection is generally started not only for non-active command value outputs, i.e. for outputs which have not requested any heating or cooling energy over the past 24 hours. For these outputs, the controller will periodically set the command value to the maximum value once a day for a duration of approx. 5 minutes.</p>

4.2.5.3 Push button interface parameter

Description	Values	Comment
☐ Push button interface		
Transmit delay after reset or bus voltage return Base	130 ms 260 ms 520 ms 1 sec 2.1 sec 4.2 sec 8.4 sec 17 sec 34 sec 1.1 min 2.2 min 4.5 min 9 min 18 min 35 min 1.2 hr	After reset or bus voltage return, the application program of the push-button interface can be disabled for a defined time period until the corresponding reactions are executed. No pending signals will be evaluated on the inputs during this time! Even a feedback will only be transmitted after the time delay has elapsed at the earliest. Determines the time base of the time delay. Time = Basic x Factor
Transmit delay after reset or bus voltage return Factor (3...127)	3... 17 ...127	Determines the time factor of the time delay. Time = Basic x Factor Presetting: 1 s × 17 = 17 s
Debouncing of the button inputs Base	0.5 ms	Specifies the time for software debounce for all the binary inputs. On the basis of the time set here, a signal edge is evaluated at the input with a delay. Time = Basic x Factor
Debouncing of the button inputs Factor (10...255)	0... 60 ...255	Specifies the time for software debounce for all the binary inputs. On the basis of the time set here, a signal edge is evaluated at the input with a delay. Time = Basic x Factor Presetting: 0,5 ms × 60 = 30 ms
Telegram rate limit	Enabled Disabled	The telegram rate limit can be disabled or enabled. If telegram rate limitation is enabled, no telegram will ever be transmitted within the first 17 seconds after bus voltage return!
Telegrams per 17 s	30 60	If telegram rate limitation is enabled, the maximum number of telegrams in 17

	100 127	seconds can be set here.
☐ Push button interface -> Channel 1		
Function input 1	No function Switching Dimming Venetian blind Value transmitter	Determines the function of input 1.
Function channel 1 = "no function"	No second parameter.	
Function channel 1 = "switching"		
Command on rising edge Switching object 1.1	no reaction ON OFF TOGGLE	Specifies the command transmitted on a rising edge via the switching object 1.1. "TOGGLE" switches over the object value.
Command on falling edge Switching object 1.1	no reaction ON OFF TOGGLE	Specifies the command transmitted on a falling edge via the switching object 1.1. "TOGGLE" switches over the object value.
Command on rising edge Switching object 1.2	no reaction ON OFF TOGGLE	Specifies the command transmitted on a rising edge via the switching object 1.2. "TOGGLE" switches over the object value.
Command on falling edge Switching object 1.2	no reaction ON OFF TOGGLE	Specifies the command transmitted on a falling edge via the switching object 1.2. "TOGGLE" switches over the object value.
Cyclical transmission ?	no cyclical transmission Repeat on ON Repeat on OFF Repeat on ON and OFF	Cyclical transmission can occur via the switching objects depending on the object value. With "no cyclical transmission", no cyclical transmission occurs. With "Repeat on ON", cyclical transmission occurs if the object value is "ON" With "Repeat on OFF", cyclical transmission occurs if the object value is "OFF" With "Repeat on ON and OFF", cyclical

		transmission always occurs regardless of the object value.
Time base for cyclical transmission of switching object 1.1	1 sec 2.1 sec 4.2 sec 8.4 sec 17 sec 34 sec 1.1 min 2.2 min 4.5 min 9 min 18 min 35 min 1.2 hr	Determines the time base for the cyclical transmission via the switching object 1.1. Time = Basic x Factor
Time base for cyclical transmission of switching object 1.2	1 sec 2.1 sec 4.2 sec 8.4 sec 17 sec 34 sec 1.1 min 2.2 min 4.5 min 9 min 18 min 35 min no cycl. transm. via switching object X.2	Determines the time base for the cyclical transmission via the switching object 1.2. The cyclical transmission via the switching object 1.2 can be disabled if "no cycl. transmission via switching object X.2" is selected" Time = Basic x Factor
Time factor for cyclical transmission of switching object 1.1 and 1.2 Factor (3...127)	3... 60 ...127	Determines the time factor for the cyclical transmission via both switching objects. Time = Basic x Factor Presetting: 1 s × 60 = 60 s
Behaviour after bus voltage return	no reaction Send ON telegram Send OFF telegram Transmit current input status	It is possible to specify which reaction should take place after bus voltage return. The configured delay time after reset or bus voltage return must first have elapsed before the pre-set reaction is executed here. With "no reaction", no reaction occurs. With "transmit current input state" the current input state of the inputs is transmitted according to the configuration for the rising and falling edge. With "transmit ON telegram" an "ON" is transmitted.

With "transmit OFF telegram" an "OFF" is transmitted.

Function channel 1 =
"Dimming"

Operation	<p>Single-surface operation: Brighter / darker (TOGGLE) Two button operation: Brighter (ON) Two button operation: Darker (OFF) Two button operation: Brighter (TOGGLE) Two button operation: Darker (TOGGLE)</p>	<p>Specifies the reaction to a rising edge at the input.</p> <p>With "Single-button operation: brighter / darker (TOGGLE)", after a brief press of the push-button at the input, the object value of the switching object is toggled and a corresponding telegram transmitted. With a long press, a dimming telegram (brighter / darker) is triggered. The dimming direction is only stored internally and switched on sequential dimming operations.</p> <p>With "Double-button operation: brighter (ON)", a brief press of a push-button at the input transmits an ON telegram, whereas a long press triggers a dimming telegram (brighter).</p> <p>With "Double-button operation: darker (OFF)", a brief press of a push-button at the input transmits an OFF telegram, whereas a long press triggers a dimming telegram (darker).</p> <p>With "Double-button operation: brighter (TOGGLE)", a brief press of a push-button at the input toggles the object value of the switching object and transmits a corresponding telegram, whereas a long press triggers a dimming telegram (brighter).</p> <p>With "Double-button operation: darker (TOGGLE)", a brief press of a push-button at the input toggles the object value of the switching object and transmits a corresponding telegram, whereas a long press triggers a dimming telegram (darker).</p>
Increase brightness by	<p>100 % 50 % 25 % 12.5 % 6 % 3 % 1.5 %</p>	<p>A dimming telegram can increase brightness by a maximum of X %. This parameter determines the maximum dimming increments for a dimming telegram. This parameter depends on the set operation.</p>
Reduce brightness by	<p>100 % 50 % 25 % 12.5 % 6 %</p>	<p>A dimming telegram can increase darkness by a maximum of X %. This parameter determines the maximum dimming increments for a dimming telegram. This parameter depends on</p>

	3 % 1.5 %	the set operation.
Time between switching and dimming, Base	130 ms 260 ms 520 ms 1 sec	Time from which the dimming function ("long press") is executed. Time = Basic x Factor
Time between switching and dimming, Factor (4...127)	4...127	Time from which the dimming function ("long press") is executed. Time = Basic x Factor Presetting: 130 ms × 4 = 520 ms
Send stop telegram ?	Yes No	One or no telegram is transmitted on releasing a pushbutton at the input (falling edge).
Telegram repeat?	Yes No	Cyclical repetition of dimming telegrams during a long press.
Time between two telegrams, Base	130 ms 260 ms 520 ms 1 sec	Time between two telegrams when telegram repetition is active. A new dimming telegram is transmitted after this time has elapsed. Only if telegram repetition ? = "YES". Time = Basic x Factor
Time between two telegrams, Factor (3...127)	3...10...127	Time between two telegrams when telegram repetition is active. A new dimming telegram is transmitted after this time has elapsed. Only if telegram repetition ? = "YES". Time = Basic x Factor Presetting: 130 ms × 10 = 1.3 s
Behaviour after bus voltage return	no reaction Send ON telegram Send OFF telegram	It is possible to specify which reaction should take place after bus voltage return. The configured delay time after reset or bus voltage return must first have elapsed before the pre-set reaction is executed here. With "no reaction", no reaction occurs. With "transmit ON telegram" an "ON" is transmitted. With "transmit OFF telegram" an "OFF" is transmitted.

Function channel 1 =
"Venetian blind"

Command on rising
edge

no reaction
UP
DOWN
TOGGLE

Specifies the reaction to a rising edge at the input.

With "no function" the input is deactivated.

With "UP" a brief press triggers a STEP telegram (UP), a long press triggers a MOVE telegram (up).

With "DOWN" a brief press triggers a STEP telegram (DOWN), a long press triggers a MOVE telegram (down).

With "TOGGLE" the movement direction is toggled internally for each long press (MOVE). If a short-time actuation transmits a STEP telegram, then this STEP is always switched in the opposite direction of the last MOVE. Several STEP telegrams transmitted successively are switched in the same direction.

Operation concept

short - long - short
long - short

Specifies the telegram sequence after actuation (rising edge).

Short - long - short:

A STEP is transmitted with a rising edge and the time T1 (Time between short and long time operation) started. This step serves to stop a continuous run in progress. If a falling edge is detected within T1, the binary input transmits no further telegram.

If no falling edge was detected during T1, the binary input transmits a MOVE automatically after T1 elapses and starts the time T2 (slat adjusting time). If a falling edge is then detected within T2, the binary input transmits a STEP. This function is used for slat adjustment. T2 should correspond to the time required for a 180° rotation of the Lamellas.

Long – short:

A MOVE is transmitted when there is a rising edge at the input and the time T1 (slat adjustment time) started. If a falling edge is detected within T1, the binary input transmits a STEP. This function is used for slat adjustment. T1 should correspond to the time required for a 180° rotation of the Lamellas.

Time between short and long time operation, Base	130 ms 260 ms 520 ms 1 sec 2.1 sec 4.2 sec 8.4 sec 17 sec 34 sec	Time after which the function of a long actuation is executed. Only for operation concept = "short – long – short". Time = Basic x Factor
Time between short and long time operation, Factor (4...127)	4...127	Time after which the function of a long actuation is executed. Only for operation concept = "short – long – short". Time = Basic x Factor Presetting: 130 ms × 4 = 520 ms
Slat adjusting time, Base	130 ms 260 ms 520 ms 1 sec 2.1 sec 4.2 sec 8.4 sec 17 sec 34 sec	Time during which a MOVE telegram for slat adjustment can be terminated by releasing the push-button at the input. Time = Basic x Factor
Slat adjusting time, Factor (3...127)	3...20...127	Time during which a MOVE telegram for slat adjustment can be terminated by releasing the push-button at the input. Time = Basic x Factor Presetting: 130 ms × 20 = 2.6 s
Behaviour after bus voltage return	no reaction UP DOWN	It is possible to specify which reaction should take place after bus voltage return. The configured delay time after reset or bus voltage return must first have elapsed before the pre-set reaction is executed here. With "no reaction", no reaction occurs. With "UP" a MOVE telegram (up) is transmitted. With "DOWN" a MOVE telegram (down) is transmitted.
Function channel 1 =	"Value transmitter"	

Function as	Dimming value transmitter Light scene extension without memory function Light scene extension with memory function Temperature value transmitter Brightness value transmitter	Determines the function to be executed.
Value transmitter function = "Dimming value transmitter"		
Transmit value on	rising edge (pushbutton as NO contact) falling edge (pushbutton as NC contact) rising and falling edge (switch)	Specifies the edge which starts an actuation.
Value on rising edge(0...255)	0... 100 ...255	Specifies the value transmitted on a rising edge. Only with "Transmit value on = rising edge (pushbutton as NO contact)" and "Transmit value on = rising and falling edge (switch)"!
Value on falling edge(0...255)	0 ...255	Specifies the value transmitted on a falling edge. Only with "Transmit value on = falling edge (pushbutton as NC contact)" and "Transmit value on = rising and falling edge (switch)"!
Adjustment via long actuation?	Yes No	With a long press (< 5 s), the current value can be cyclically reduced or increased by the parameterized step width (see below) and transmitted. After this value adjustment, the value last transmitted remains stored. The parameter defines whether a value adjustment is possible Only with "Transmit value on = rising edge (pushbutton as NO contact)" and "Transmit value on = falling edge (pushbutton as NC contact)".

Time between two telegrams, Base	130 ms 260 ms 520 ms 1 sec	Time base for the time between two cyclical telegrams during value adjustment. Only with "Adjustment via long actuation? = Yes"!
Time between two telegrams, Factor (3...127)	3...127	Time factor for the time between two cyclical telegrams during value adjustment. Only with "Adjustment via long actuation? = Yes"! Time = Basic x Factor Presetting: 520 ms × 3 = 1.56 s
Step width (1...10)	1...10	Increments by which the adjusted value is increased or decreased with long actuation. Only with "Adjustment via long actuation? = Yes"!
Behaviour after bus voltage return	no reaction Reaction as rising edge Reaction as falling edge Transmit current input status	It is possible to specify which reaction should take place after bus voltage return. If a delay after bus voltage return is configured, this time must first have elapsed before the pre-set reaction is executed here. With "no reaction", no reaction occurs. With "Reaction as with rising edge", the value parameterized for the rising edge will be transmitted. Only with "Transmit value on = rising edge (pushbutton as NO contact)" and "Transmit value on = rising and falling edge (switch)"! With "Reaction as with falling edge", the value parameterized for the falling edge will be transmitted Only with "Transmit value on = falling edge (pushbutton as NC contact)" and "Transmit value on = rising and falling edge (switch)"! With "transmit current input state" the current input state of the inputs is transmitted according to the configuration for the rising and falling edge. Only with "Transmit value on = raising and falling edge (switch)"!

Value transmitter
function = "Light scene
extension without
memory function"

Transmit light scene number on	rising edge (pushbutton as NO contact) falling edge (pushbutton as NC contact) rising and falling edge (switch)	Specifies the edge which starts an actuation.
Light scene on rising edge(1...64)	1...64	Specifies the light scene transmitted on a rising edge. Only with "Transmit light scene number on = rising edge (pushbutton as NO contact)" and "Transmit light scene number on = rising and falling edge (switch)"!
Light scene on falling edge(1...64)	1...64	Specifies the light scene transmitted on a falling edge. Only with "Transmit light scene number on = falling edge (pushbutton as NC contact)" and "Transmit light scene number on = rising and falling edge (switch)"!
Behaviour after bus voltage return	no reaction Reaction as rising edge Reaction as falling edge Transmit current input status	It is possible to specify which reaction should take place after bus voltage return. If a delay after bus voltage return is configured, this time must first have elapsed before the pre-set reaction is executed here. With "no reaction", no reaction occurs. With "Reaction as with rising edge", the light scene parameterized for the rising edge will be transmitted. Only with "Transmit light scene number on = rising edge (pushbutton as NO contact)" and "Transmit light scene number on = rising and falling edge (switch)"! With "Reaction as with falling edge", the light scene parameterized for the falling edge will be transmitted. Only with "Transmit light scene number on = falling edge (pushbutton as NC

		contact)" and "Transmit light scene number on = rising and falling edge (switch)"!
		With "transmit current input state" the current input state of the inputs is transmitted according to the configuration for the rising and falling edge. Only with "Transmit light scene number on = raising and falling edge (switch)"!
Value transmitter function = "Light scene extension with memory function"		
Transmit light scene number on	rising edge (pushbutton as NO contact) falling edge (pushbutton as NC contact)	Specifies the edge which starts an actuation.
Light scene on rising edge(1...64)	1...64	Specifies the light scene transmitted on a rising edge. Only with "Transmit light scene number on = raising edge (pushbutton as NO contact)"!
Light scene on falling edge(1...64)	1...64	Specifies the light scene transmitted on a falling edge. Only with "Transmit light scene number on = falling edge (pushbutton as NC contact)"!
Only memory function ?	Yes No	It is possible, only transmitting a memory telegram without prior light scene recall.
Time for long actuation for storage, Base	130 ms 260 ms 520 ms 1 sec	Time base for time for a long actuation to transmit a storage telegram Only when "only memory function ?" = no"! Time = Basic x Factor
Time for long actuation for storage, Factor (9...127)	9... 10 ...127	Time factor for time for a long actuation to transmit a storage telegram. Only when "only memory function ?" = NO"! Time = Basic x Factor

Presetting: 520 ms × 10 = 5.2 s

Behaviour after bus voltage return

no reaction
Reaction as rising edge
Reaction as falling edge

It is possible to specify which reaction should take place after bus voltage return. If a delay after bus voltage return is configured, this time must first have elapsed before the pre-set reaction is executed here.

With "no reaction", no reaction occurs.

With "Reaction as with rising edge", the light scene parameterized for the rising edge will be transmitted. Only with "Transmit light scene number on = raising edge (pushbutton as NO contact)"!

With "Reaction as with falling edge", the light scene parameterized for the falling edge will be transmitted. Only with "Transmit light scene number on = falling edge (pushbutton as NC contact)"!

Value transmitter = "Temperature value transmitter"

Transmit value on

rising edge (pushbutton as NO contact)
falling edge (pushbutton as NC contact)
rising and falling edge (switch)

Specifies the edge which starts an actuation.

Value on rising edge

0...**20**...40 °C in 1 °C increments

Setting of the temperature value to be transmitted.

Only with "Transmit value on = rising edge (pushbutton as NO contact)" and "Transmit value on = rising and falling edge (switch)"!

Value on falling edge

0...**18**...40 °C in 1 °C increments

Setting of the temperature value to be transmitted.

Only with "Transmit value on = falling edge (pushbutton as NC contact)" and "Transmit value on = rising and falling edge (switch)"!

Adjustment via long actuation?	Yes No	<p>With a long press (< 5 s), the current value can be cyclically reduced or increased by the parameterized step width (see below) and transmitted. After this value adjustment, the value last transmitted remains stored. This parameter defines whether a value adjustment is possible</p> <p>Only with "Transmit value on = rising edge (pushbutton as NO contact)" and "Transmit value on = falling edge (pushbutton as NC contact)".</p>
Time between two telegrams, Base	130 ms 260 ms 520 ms 1 sec	<p>Time base for the time between two cyclical telegrams during value adjustment.</p> <p>Only with "Adjustment via long actuation? = Yes"!</p> <p>Time = Basic x Factor</p>
Time between two telegrams, Factor (3...127)	3...127	<p>Time factor for the time between two cyclical telegrams during value adjustment.</p> <p>Only with "Adjustment via long actuation? = Yes"!</p> <p>Time = Basic x Factor</p> <p>Presetting: 520 ms × 3 = 1.56 s</p>
Step width	1 K	<p>The step width of the adjustment is permanently set to 1 K. Only with "Adjustment via long actuation? = Yes".</p>
Behaviour after bus voltage return	No reaction Reaction as rising edge Reaction as falling edge Transmit current input status	<p>It is possible to specify which reaction should take place after bus voltage return. If a delay after bus voltage return is configured, this time must first have elapsed before the pre-set reaction is executed here.</p> <p>With "no reaction", no reaction occurs.</p> <p>With "Reaction as with rising edge", the value parameterized for the rising edge will be transmitted. Only with "Transmit value on = rising edge (pushbutton as NO contact)" and "Transmit value on = rising and falling edge (switch)"!</p> <p>With "Reaction as with falling edge", the</p>

		<p>value parameterized for the falling edge will be transmitted. Only with "Transmit value on = falling edge (pushbutton as NC contact)" and "Transmit value on = rising and falling edge (switch)"!</p> <p>With "transmit current input state" the current input state of the inputs is transmitted according to the configuration for the rising and falling edge. Only with "Transmit value on = raising and falling edge (switch)"!</p>
Value transmitter function = "Brightness value transmitter"		
Transmit value on	<p>rising edge (pushbutton as NO contact) falling edge (pushbutton as NC contact) rising and falling edge (switch)</p>	Specifies the edge which starts an actuation.
Value on rising edge	0... 200 ...1500 lux in 50 lux increments	<p>Setting of the brightness value to be transmitted.</p> <p>Only with "Transmit value on = rising edge (pushbutton as NO contact)" and "Transmit value on = rising and falling edge (switch)"!</p>
Value on falling edge	0 ...1500 lux in 50 lux increments	<p>Setting of the brightness value to be transmitted.</p> <p>Only with "Transmit value on = falling edge (pushbutton as NC contact)" and "Transmit value on = rising and falling edge (switch)"!</p>
Adjustment via long actuation?	<p>Yes No</p>	<p>With a long press (< 5 s), the current value can be cyclically reduced or increased by the parameterized step width (see below) and transmitted. After this value adjustment, the value last transmitted remains stored. This parameter defines whether a value adjustment is possible</p> <p>Only with "Transmit value on = rising edge (pushbutton as NO contact)" and "Transmit value on = falling edge (switch)"!</p>

		(pushbutton as NC contact)".
Time between two telegrams, Base	130 ms 260 ms 520 ms 1 sec	Time base for the time between two cyclical telegrams during value adjustment. Only with "Adjustment via long actuation? = Yes!" Time = Basic x Factor
Time between two telegrams, Factor (3...127)	3...127	Time factor for the time between two cyclical telegrams during value adjustment. Only with "Adjustment via long actuation? = Yes!" Time = Basic x Factor Presetting: 520 ms × 3 = 1.56 s
Step width	50 lux	The step width of the adjustment is permanently set to 50 Lux. Only with "Adjustment via long actuation? = Yes".
Behaviour after bus voltage return	no reaction Reaction as rising edge Reaction as falling edge Transmit current input status	It is possible to specify which reaction should take place after bus voltage return. If a delay after bus voltage return is configured, this time must first have elapsed before the pre-set reaction is executed here. With "no reaction", no reaction occurs. With "Reaction as with rising edge", the value parameterized for the rising edge will be transmitted. Only with "Transmit value on = rising edge (pushbutton as NO contact)" and "Transmit value on = rising and falling edge (switch)"! With "Reaction as with falling edge", the value parameterized for the falling edge will be transmitted. Only with "Transmit value on = falling edge (pushbutton as NC contact)" and "Transmit value on = rising and falling edge (switch)"! With "transmit current input state" the current input state of the inputs is transmitted according to the configuration for the rising and falling edge.

Only with "Transmit value on = raising and falling edge (switch)"!

☐ Push button interface -> Channel 1 -> Disable

Disable for function
"Switching"

Disabling function
Switching object 1.1 /
1.2

enabled
disabled

The disabling function can be disabled or enabled via its own object.

Polarity of the disabling
object

Disable = 1 (Enable = 0)
Disable = 0 (Enable = 1)

This parameter sets the polarity of the disabling object.

Behaviour at the
beginning of the
disabling function
Switching object 1.1 /
1.2

no reaction
On
Off
Toggle

Both switching objects can be separately disabled. This parameter determines the commands that are transmitted via the respective switching objects at the beginning of the disable. With "TOGGLE" the object values are toggled.

Behaviour at the end of
the disabling function
Switching object 1.1 /
1.2

no reaction
On
Off
Transmit current input
status

Both switching objects can be separately disabled. This parameter determines the commands that are transmitted via the respective switching objects at the start of the disable.

With "transmit current input state" the current input state of the inputs is transmitted according to the configuration for the rising and falling edge.

Disable for function
"Dimming"

Disabling function

enabled
disabled

The disabling function can be enabled or disabled.

Polarity of the disabling
object

Disable = 1 (Enable = 0)
Disable = 0 (Enable = 1)

This parameter sets the polarity of the disabling object.

Behaviour at the
beginning of the
disabling function

no reaction
On
Off
Toggle

This parameter specifies the command transmitted via the "Switching" object at the beginning of the disabling. With "TOGGLE" the object values are

		toggled.
Behaviour at the end of the disabling function	no reaction Off	This parameter specifies the command transmitted via the "Switching" object at the end of the disabling.
Disable for function "Venetian blind"		
Disabling function	enabled disabled	The disabling function can be enabled or disabled.
Polarity of the disabling object	Disable = 1 (Enable = 0) Disable = 0 (Enable = 1)	This parameter sets the polarity of the disabling object.
Behaviour at the beginning of the disabling function	no reaction Down Up Toggle	This parameter specifies the command transmitted via the long time object at the beginning of the disabling. With "TOGGLE" the last executed (internally stored) movement direction is toggled
Behaviour at the end of the disabling function	no reaction Down Up Toggle	This parameter specifies the command transmitted via the long time object at the end of the disabling. With "TOGGLE" the last executed (internally stored) movement direction is toggled
Disable for function "Dimming value transmitter"		
Disabling function	enabled disabled	The disabling function can be enabled or disabled.
Polarity of the disabling object	Disable = 1 (Enable = 0) Disable = 0 (Enable = 1)	This parameter sets the polarity of the disabling object.
Behaviour at the beginning of the disabling function	no reaction Reaction as rising edge Reaction as falling edge Transmit current input status	This parameter determines the reaction executed at the beginning of the disabling. With "no reaction", no reaction occurs. With "Reaction as with rising edge", the value parameterized for the rising edge will be transmitted.

		Only with "Transmit value on = rising edge (pushbutton as NO contact)" and "Transmit value on = rising and falling edge (switch)"!
		With "Reaction as with falling edge", the value parameterized for the falling edge will be transmitted.
		Only with "Transmit value on = falling edge (pushbutton as NC contact)" and "Transmit value on = rising and falling edge (switch)"!
		With "transmit current input state" the current input state of the inputs is transmitted according to the configuration for the rising and falling edge.
		Only with "Transmit value on = raising and falling edge (switch)"!
Behaviour at the end of the disabling function	no reaction Reaction as rising edge Reaction as falling edge Transmit current input status	This parameter determines the reaction executed at the end of the disabling. With "no reaction", no reaction occurs. With "Reaction as with rising edge", the value parameterized for the rising edge will be transmitted. Only with "Transmit value on = rising edge (pushbutton as NO contact)" and "Transmit value on = rising and falling edge (switch)"! With "Reaction as with falling edge", the value parameterized for the falling edge will be transmitted. Only with "Transmit value on = falling edge (pushbutton as NC contact)" and "Transmit value on = rising and falling edge (switch)"! With "transmit current input state" the current input state of the inputs is transmitted according to the configuration for the rising and falling edge. Only with "Transmit value on = raising and falling edge (switch)"!
Disable for function "Light scene extension without memory		

function "

Disabling function	enabled disabled	The disabling function can be enabled or disabled.
Polarity of the disabling object	Disable = 1 (Enable = 0) Disable = 0 (Enable = 1)	This parameter sets the polarity of the disabling object.
Behaviour at the beginning of the disabling function	no reaction Reaction as rising edge Reaction as falling edge Transmit current input status	<p>This parameter determines the reaction executed at the beginning of the disabling.</p> <p>With "no reaction", no reaction occurs.</p> <p>With "Reaction as with rising edge", the light scene parameterized for the rising edge will be transmitted. Only with "Transmit light scene number on = rising edge (pushbutton as NO contact)" and "Transmit light scene number on = rising and falling edge (switch)"!</p> <p>With "Reaction as with falling edge", the light scene parameterized for the falling edge will be transmitted. Only with "Transmit light scene number on = falling edge (pushbutton as NC contact)" and "Transmit light scene number on = rising and falling edge (switch)"!</p> <p>With "transmit current input state" the current input state of the inputs is transmitted according to the configuration for the rising and falling edge. Only with "Transmit light scene number on = raising and falling edge (switch)"!</p>
Behaviour at the end of the disabling function	no reaction Reaction as rising edge Reaction as falling edge Transmit current input status	<p>This parameter determines the reaction executed at the end of the disabling.</p> <p>With "no reaction", no reaction occurs.</p> <p>With "Reaction as with rising edge", the light scene parameterized for the rising edge will be transmitted. Only with "Transmit light scene number on = rising edge (pushbutton as NO contact)" and "Transmit light scene number on = rising and falling edge (switch)"!</p> <p>With "Reaction as with falling edge", the light scene parameterized for the falling</p>

		edge will be transmitted. Only with "Transmit light scene number on = falling edge (pushbutton as NC contact)" and "Transmit light scene number on = rising and falling edge (switch)"!
		With "transmit current input state" the current input state of the inputs is transmitted according to the configuration for the rising and falling edge. Only with "Transmit light scene number on = raising and falling edge (switch)"!
Disable for function "Light scene extension with memory function "		
Disabling function	enabled disabled	The disabling function can be enabled or disabled.
Polarity of the disabling object	Disable = 1 (Enable = 0) Disable = 0 (Enable = 1)	This parameter sets the polarity of the disabling object.
Behaviour at the beginning of the disabling function	no reaction Reaction as rising edge Reaction as falling edge	This parameter determines the reaction executed at the beginning of the disabling. With "no reaction", no reaction occurs. With "Reaction as with rising edge", the value parameterized for the rising edge will be transmitted. Only with "Transmit light scene number on = raising edge (pushbutton as NO contact)"! With "Reaction as with falling edge", the light scene parameterized for the falling edge will be transmitted. Only with "Transmit light scene number on = falling edge (pushbutton as NC contact)"!
Behaviour at the end of the disabling function	no reaction Reaction as rising edge Reaction as falling edge	This parameter determines the reaction executed at the end of the disabling. With "no reaction", no reaction occurs. With "Reaction as with rising edge", the value parameterized for the rising edge will be transmitted. Only with "Transmit light scene number on = raising edge (pushbutton as NO contact)"!

		With "Reaction as with falling edge", the light scene parameterized for the falling edge will be transmitted. Only with "Transmit light scene number on = falling edge (pushbutton as NC contact)"!
Disable for function "Temperature value transmitter"		
Disabling function	enabled disabled	The disabling function can be enabled or disabled.
Polarity of the disabling object	Disable = 1 (Enable = 0) Disable = 0 (Enable = 1)	This parameter sets the polarity of the disabling object.
Behaviour at the beginning of the disabling function	no reaction Reaction as rising edge Reaction as falling edge Transmit current input status	<p>This parameter determines the reaction executed at the beginning of the disabling.</p> <p>With "no reaction", no reaction occurs.</p> <p>With "Reaction as with rising edge", the value parameterized for the rising edge will be transmitted.</p> <p>Only with "Transmit value on = rising edge (pushbutton as NO contact)" and "Transmit value on = rising and falling edge (switch)"!</p> <p>With "Reaction as with falling edge", the value parameterized for the falling edge will be transmitted.</p> <p>Only with "Transmit value on = falling edge (pushbutton as NC contact)" and "Transmit value on = rising and falling edge (switch)"!</p> <p>With "transmit current input state" the current input state of the inputs is transmitted according to the configuration for the rising and falling edge.</p> <p>Only with "Transmit value on = raising and falling edge (switch)"!</p>
Behaviour at the end of the disabling function	no reaction Reaction as rising edge Reaction as falling edge	This parameter determines the reaction executed at the end of the disabling.

	<p>Transmit current input status</p>	<p>With "no reaction", no reaction occurs.</p> <p>With "Reaction as with rising edge", the value parameterized for the rising edge will be transmitted.</p> <p>Only with "Transmit value on = rising edge (pushbutton as NO contact)" and "Transmit value on = rising and falling edge (switch)"!</p> <p>With "Reaction as with falling edge", the value parameterized for the falling edge will be transmitted.</p> <p>Only with "Transmit value on = falling edge (pushbutton as NC contact)" and "Transmit value on = rising and falling edge (switch)"!</p> <p>With "transmit current input state" the current input state of the inputs is transmitted according to the configuration for the rising and falling edge.</p> <p>Only with "Transmit value on = raising and falling edge (switch)"!</p>
<p>Disable for function "Brightness value transmitter"</p>		
<p>Disabling function</p>	<p>enabled disabled</p>	<p>The disabling function can be enabled or disabled.</p>
<p>Polarity of the disabling object</p>	<p>Disable = 1 (Enable = 0) Disable = 0 (Enable = 1)</p>	<p>This parameter sets the polarity of the disabling object.</p>
<p>Behaviour at the beginning of the disabling function</p>	<p>no reaction Reaction as rising edge Reaction as falling edge Transmit current input status</p>	<p>This parameter determines the reaction executed at the beginning of the disabling.</p> <p>With "no reaction", no reaction occurs.</p> <p>With "Reaction as with rising edge", the value parameterized for the rising edge will be transmitted.</p> <p>Only with "Transmit value on = rising edge (pushbutton as NO contact)" and "Transmit value on = rising and falling edge (switch)"!</p> <p>With "Reaction as with falling edge", the value parameterized for the falling edge</p>

Behaviour at the end of the disabling function

no reaction
Reaction as rising edge
Reaction as falling edge
Transmit current input status

will be transmitted.

Only with "Transmit value on = falling edge (pushbutton as NC contact)" and "Transmit value on = rising and falling edge (switch)"!

With "transmit current input state" the current input state of the inputs is transmitted according to the configuration for the rising and falling edge.

Only with "Transmit value on = raising and falling edge (switch)"!

This parameter determines the reaction executed at the end of the disabling.

With "no reaction", no reaction occurs.

With "Reaction as with rising edge", the value parameterized for the rising edge will be transmitted.

Only with "Transmit value on = rising edge (pushbutton as NO contact)" and "Transmit value on = rising and falling edge (switch)"!

With "Reaction as with falling edge", the value parameterized for the falling edge will be transmitted.

Only with "Transmit value on = falling edge (pushbutton as NC contact)" and "Transmit value on = rising and falling edge (switch)"!

With "transmit current input state" the current input state of the inputs is transmitted according to the configuration for the rising and falling edge.

Only with "Transmit value on = raising and falling edge (switch)"!

Push button interface -> Channel 2

Channel 2

See channel 1!

Push button interface -> Channel 2 -> Disable

Channel 2 - Disable

See channel 1 -
Disable!

4.2.5.4 Logic gate parameter

Description	Values	Comment
□- Logic gate		
Number of logic gates	no logic gates 1 logic gates 2 logic gates 3 logic gates 4 logic gates	This parameter determines how many logic gates are available.
□- Logic gate -> logic gate x (x = 1...4)		
Type of logic operation	OR AND Exclusive OR AND with feedback	This parameter defines which logic operation is created by the gate. NAND and NOR gates can be implemented by inversion of the output.
Number of inputs	1 input 2 inputs 3 inputs 4 inputs	This parameter determines how many inputs are available to each logic gate.
Number and type of output objects	1 switching object 1 value object 2 switching objects 2 value objects 1 switching object and 1 value object	This parameter determines the type and number of output objects of the gate.
Send output at	each input event Change the output	This parameter determines when the output objects are updated. With "every event": the output object is updated for every input event. If, for example, a "1" is transmitted cyclically to an input, then the output state is updated in the same cycle and, depending on the set transmission behaviour, also transmitted if necessary. With "Change the output": The output object is only updated, and, depending on the set transmission behaviour, also saved if necessary, if the output changes from "0" to "1" or from "1" to "0".
Transmission behaviour for logic 0	No telegram Transmission without delay Transmission delay	The transmission behaviour of the gate output is defined here for the state "0". With "no telegram": No telegram is generally transmitted for the output state "0". With "Transmission without delay": During each update of the output state (see "Send output at), a state "0" is

		transmitted without delay, i.e. instantly. With "Transmission delay": During each update of the output state (see "Send output at), a state "0" is transmitted with delay.
Lenght of transmission delay Base	100ms 1s 1 min	This parameter defines the duration of the transmission delay for a logic "0" on the gate output. Setting the basis of the transmission delay. Only visible in "Transmission behaviour for logic 0 = transmission delay".
Lenght of transmission delay Factor (1...100)	1 ...100	Setting the factor of the transmission delay. Only visible in "Transmission behaviour for logic = transmission delay".
Transmission behaviour for logic 1	No telegram Transmission without delay Transmission delay	The transmission behaviour of the gate output is defined here for the state "1". With "no telegram": No telegram is generally transmitted for the output state "1". With "Transmission without delay": During each update of the output state (see "Send output at), a state "1" is transmitted without delay, i.e. instantly. With "Transmission delay": During each update of the output state (see "Send output at), a state "1" is transmitted with delay.
Lenght of transmission delay Base	100ms 1s 1 min	This parameter defines the duration of the transmission delay for a logic "1" on the gate output. Setting the basis of the transmission delay. Only visible in "Transmission behaviour for logic 1 = transmission delay".
Lenght of transmission delay Factor (1...100)	1 ...100	Setting the factor of the transmission delay. Only visible in "Transmission behaviour for logic = transmission delay".
Cyclical transmission of output object(s) (0...120) * 10 s; 0 = inactive	0 ...120	Here you can set whether and within which time interval the result of the logic operation is transmitted cyclically. The value "0" means that no cyclic sending is carried out.

☐ Logic gate -> logic gate x (x = 1...4) -> Input / Inputs

The following parameters for the logic gate inputs are available in the same way for each configured input (1...4).

Connection	external input object Humidity measurement - LV1 CO2 measurement - LV1 Humidity measurement - LV2 CO2 measurement - LV2 CO2 measurement - LV3 CO2 measurement - LV4 Dew point alarm1 (Switching) Dew point alarm2 (Switching) Logic gate1 - Output1 (Switching) Logic gate1 - Output2 (Switching) Logic gate2 - Output1 (Switching) Logic gate2 - Output2 (Switching) Logic gate3 - Output1 (Switching) Logic gate3 - Output2 (Switching) Logic gate4 - Output1 (Switching) Logic gate4 - Output2 (Switching)	This parameter defines with which logic gate output, dew point alarm object or limiting value object the corresponding input of the gate is connected (internal connection). In addition to the internal connection possibilities, an external 1-bit communication object can also be assigned to the input of the gate (setting "external input object"). Make sure that the configured internal connection is also possible, the selected logic gate output, dew point alarm or limiting value is also present and thus available!
Behaviour	Normal Inverted	This parameter defines whether the gate input is evaluated normal or inverted.

☐ Logic gate -> logic gate x (x = 1...4) -> Output / Outputs

The following parameters for the logic gate outputs are available in the same way for each configured output (1...2).

Switching command for logic 0	OFF ON	This parameter defines which switching command should be transmitted to the bus for a logical "0" on the logic gate output. This parameter is only visible when the gate output is configured as "switching object".
-------------------------------	------------------	---

Switching command for logic 1	OFF ON	This parameter defines which switching command should be transmitted to the bus for a logical "1" on the logic gate output. This parameter is only visible when the gate output is configured as "switching object".
Value for logic 0	0 ...255	This parameter defines which value should be transmitted to the bus for a logical "0" on the logic gate output. This parameter is only visible when the gate output is configured as "value object".
Value for logic 1	0... 255	This parameter defines which value should be transmitted to the bus for a logical "1" on the logic gate output. This parameter is only visible when the gate output is configured as "value object".

5 Appendix

5.1 Index

Numerical

2-point feedback control..... 75

A

Accept setpoints permanently..... 94

Adapting.....73,75

automatic frost protection..... 82

B

Basic setpoint shift.....94

C

Clipping..... 106

Comfort extension.....82

Command value limit..... 104

Command value objects..... 100

commissioning..... 11,17

communication objects..... 18

control algorithm..... 66

Controller status.....102

D

dew point mode..... 107

E

ETS 11,17

ETS search paths..... 13

H

Hysteresis..... 57

L

limiting value specification..... 57

Logic gates..... 109

M

measured value formation..... 97

mixed operating mode..... 64

O

operating mode after a reset..... 83

Operating mode switchover..... 76

operating modes..... 63,76

P

PI control.....67,73

Presence function..... 82

product database..... 17

R

Response of the limiting value object 59

S

Setpoint temperature presetting..... 85

Setpoint temperatures..... 86

single operating modes.....63

Switching 2-point feedback control..... 69

Switching PI control..... 67

T

teaching function.....57,60

Temperature detection.....97

V

Valve protection..... 108

W

window status..... 82



Berker GmbH & Co. KG

Klagebach 38

58579 Schalksmühle/Germany

Telefon + 49 (0) 2355/905-0

Telefax + 49 (0) 2355/905-111

www.berker.de