

Glass sensor 2gang with room thermostat

Glass sensor 3gang with room thermostat



Issue: 07.01.2014
65750120 R3

Contents

1	Product definition	4
1.1	Product catalogue	4
1.2	Function	4
1.3	Accessories	6
2	Installation, electrical connection and operation	7
2.1	Safety instructions	7
2.2	Device components	8
2.3	Fitting and electrical connection	10
2.4	Commissioning	14
2.5	Operation	15
2.5.1	Basic display	15
2.5.2	Basic setpoint shift	17
2.5.3	Second operating level	19
3	Technical data	27
4	Software description	28
4.1	Software specification	28
4.2	Software "Glass sensor x with RTR 16Bx11/16Bx12"	29
4.2.1	Scope of functions	29
4.2.2	Notes on software	32
4.2.3	Object table	33
4.2.3.1	Object table, push button sensor function section	33
4.2.3.2	Object table, controller function section	45
4.2.3.3	Display object table	61
4.2.4	Functional description	65
4.2.4.1	Push button sensor	65
4.2.4.1.1	Operation concept and button evaluation	65
4.2.4.1.2	Function of the display buttons	69
4.2.4.1.3	Switching function	70
4.2.4.1.4	Dimming function	71
4.2.4.1.5	Venetian blind function	73
4.2.4.1.6	Value transmitter function	77
4.2.4.1.7	Scene extension function	80
4.2.4.1.8	2-channel operation function	81
4.2.4.1.9	Controller extension function	83
4.2.4.1.10	"Fan control" function	84
4.2.4.1.11	"Controller operating mode" function	85
4.2.4.1.12	"Setpoint shift" function	86
4.2.4.1.13	Status LED	87
4.2.4.1.14	Disabling function	89
4.2.4.1.15	Transmission delay	92
4.2.4.1.16	Alarm signal	93
4.2.4.2	Room temperature controller	94
4.2.4.2.1	Operating modes and operating mode change-over	94
4.2.4.2.2	Control algorithms and calculation of command values	97
4.2.4.2.3	Adapting the control algorithms	105
4.2.4.2.4	Operating mode switchover	108
4.2.4.2.5	Temperature setpoints	117
4.2.4.2.6	Room temperature measurement	131
4.2.4.2.7	Command value and status output	138
4.2.4.2.8	Fan controller	143
4.2.4.2.9	Disable functions of the room temperature controller	150
4.2.4.2.10	Valve protection	151
4.2.4.3	Room temperature controller extension	152

4.2.4.3.1	Connection to room temperature controller	152
4.2.4.3.2	Operating functions	155
4.2.4.3.3	Display functions	158
4.2.4.3.4	Room temperature measurement	160
4.2.4.3.5	Behaviour after a device restart	161
4.2.4.4	Scene function	162
4.2.4.5	Delivery state	165
4.2.4.6	Display	166
4.2.4.6.1	Displayed information	166
4.2.4.6.2	Display control	170
4.2.5	Parameters	172
4.2.5.1	General parameters	172
4.2.5.2	Parameters on the push button sensor function section	174
4.2.5.3	Parameter for the controller function section	206
4.2.5.4	Parameters for the display	232
4.2.5.5	Parameter on scene function	235
5	Appendix	238
5.1	Index	238

1 Product definition

1.1 Product catalogue

Product name:	Glass sensor 2gang with RTR and display / Glass sensor 3gang with RTR and display
Use:	Sensor
Design:	FM (flush-mounted)
Order No.	7564 2x xx / 7564 3x xx

1.2 Function

The glass sensor consists of several sensor areas, which can be operated by touching them with your finger. With the sensor surfaces, a distinction is made between the display buttons and the buttons of the push button sensor function. The display buttons are located immediately to the left and right of the display and operate predefined functions of the integrated room temperature controller or the controller extension. In addition, these buttons can also be used to activate the Cleaning function to clean the glass surface. The buttons beneath are allocated to the push button sensor function. The number of these buttons depends on the device variant. The push button sensor function is an independent function section of the device with its own parameter blocks in the ETS.

Push button functionality:

When a sensor area is pressed, the glass sensor sends telegrams to the KNX / EIB, depending on the ETS parameter settings. These can be, for instance, telegrams for switching or push button control, for dimming or for controlling blinds. It is also possible to program value transmitter functions, such as dimming value transmitters, light scene extensions, temperature value transmitters or brightness value transmitters.

In conjunction with a room temperature controller equipped with a 1-byte object for switching the modes of operation, the glass sensor can be used as a full-featured controller extension. The device can also be used for presence detection or for setpoint shifting purposes and to indicate different controller states.

In the ETS, the control concept of the operating areas can either be configured as a rocker function or as a button function. With the rocker function, two neighbouring sensor buttons are assigned an identical function. For the button function, each sensor area is evaluated separately, meaning that different functions can be executed. When two sensors surfaces are combined into one rocker, it is also possible to trigger special functions by a press on the whole surface. Full-surface operation is simultaneous operation of both sensor areas (left / right) of the rocker.

Next to each sensor surface, there is a status LED, which can be connected to the control function, according to the function of the rocker or button. Each status LEDs can then also signal completely independent display information, operating states of room temperature controllers or indicate the results of logic value comparisons, flash or be permanently switched on or off.

Room temperature controller functionality:

The glass sensor can be used for single-room temperature control. Depending on the operating mode, the current temperature setpoint and on the room temperature, a command value for heating or cooling control can be sent to the KNX/EIB for the control circuit. In addition to the heating or cooling basic level, activating an additional heater and/or cooling unit means that an additional heating or cooling unit can be used. In this connection, you can set the temperature setpoint difference between the basic and the additional level by a parameter in the ETS. For major deviations between the temperature setpoint and the actual temperature, you can activate this additional level to heat up or cool down the room faster. You can assign different control algorithms to the basic and additional stages.

For heating and cooling functions, you can select continuous or switching PI or switching 2-point feedback control algorithms.

The room temperature can be recorded either by the internal or by an external temperature

sensor. Combined temperature recording by both sensors can also be configured. Optionally, a wired floor temperature/remote sensor can be connected directly to the glass sensor, which can either be used as a temperature sensor for measuring the room temperature, or alternatively can be used to limit the floor temperature.

The controller distinguishes between different operating modes (comfort, standby, night, frost/heat protection) each with their own temperature setpoints for heating or cooling.

General:

A bus coupling unit is already permanently integrated in the glass sensor, allowing the device to be connected directly to the bus line during commissioning.

When used, an operation LED can either serve as an orientation light (also flashing), or can be activated via a separate communication object. When the push button sensor is in the programming mode, the operation LED flashes with a frequency of about 8 Hz. The same flashing rate is also used for indicating that a rocker has been actuated by a press on the full surface. In this case the LED returns to the programmed behaviour after the operation. If no or a wrong application has been loaded into the pushbutton sensor, the operation LED flashes with a frequency of about 0.75 Hz to indicate an error. The device does not then work.

1.3 Accessories

Wall box 2gang
Floor temperature sensor/remote sensor

Order No. 1871
Order No. 161

2 Installation, electrical connection and operation

2.1 Safety instructions

Electrical equipment may only be installed and fitted by electrically skilled persons. The applicable accident prevention regulations must be observed.

Failure to observe the instructions may cause damage to the device and result in fire and other hazards.

Do not use sharp objects for cleaning. Do not use sharp cleaning agents, acids or organic solvents.

Do not operate the device with sharp or pointed objects. The surface could be damaged.

The device may not be opened or operated outside the technical specifications.

Make sure during the installation that there is always sufficient insulation between the mains voltage and the bus. A minimum distance of at least 4 mm must be maintained between bus conductors and mains voltage cores.

2.2 Device components

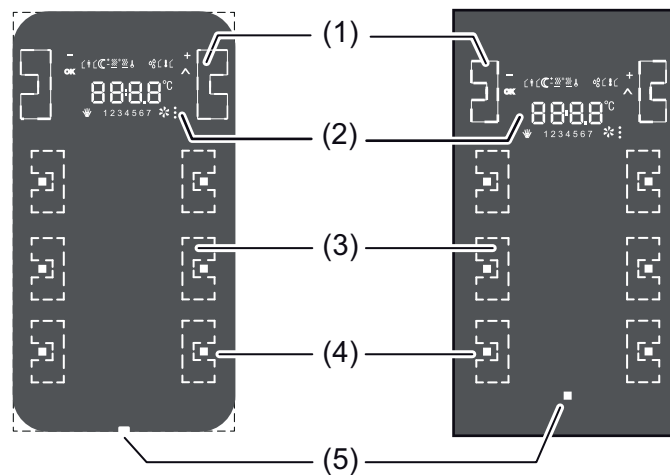

Figure 1: Device components, front side, using the "3-gang" variant as an example
Left: R.x design / Right: TS design

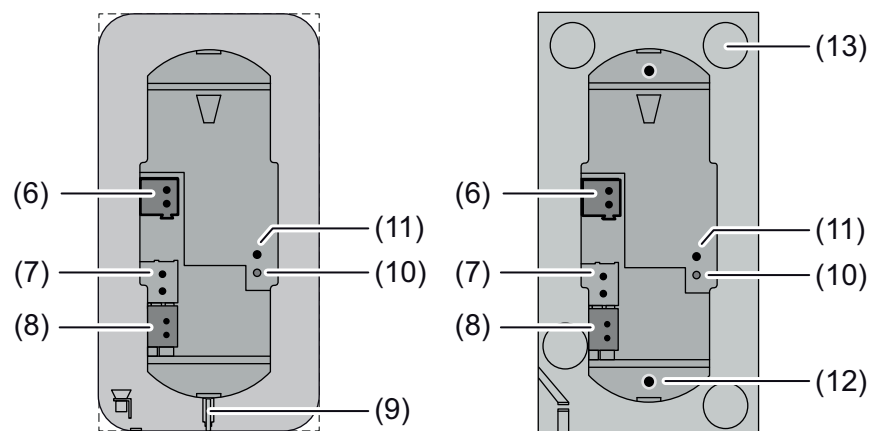

Figure 2: Device components, rear side
Left: R.x design / Right: TS design

- (1) Sensor areas for display operation (display buttons)
- (2) LED display with backlighting
- (3) Sensor areas for push button sensor operation (number depending on the device variant)
- (4) Status LED (white / 1 x for each sensor area for push button sensor operation)
- (5) Operation LED (blue)
- (6) Screwless terminal connection for additional power supply
- (7) Screwless terminal connection for wired floor temperature/remote sensors (optional accessories)
- (8) Screwless terminal connection for KNX bus line
- (9) Fibre-optic cable for operation LED
- (10) Programming LED (red)
- (11) Programming button
- (12) Retaining peg

(13) Adhesion points for adhesive dots

2.3 Fitting and electrical connection

Mounting and connecting the Touch sensor R.x

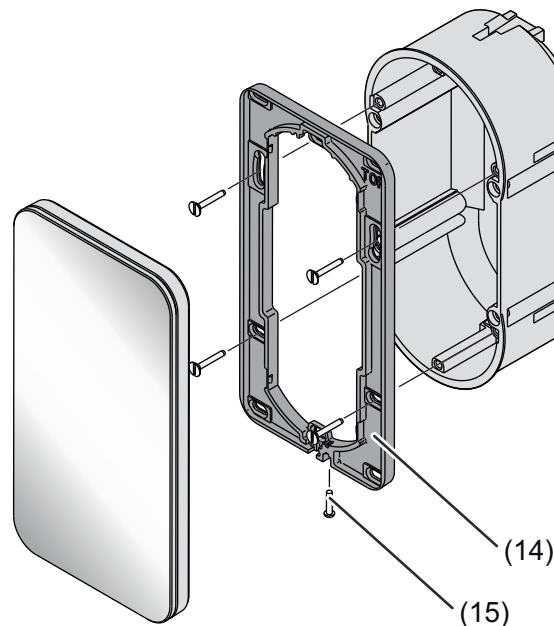

Figure 3: Device fitting

(14) Mounting frame

(15) Retaining screw

The device is installed by screwing the mounting frame to the flush-mounted box or to the wall. Increased dismantling protection is achieved by securing the device on the bottom of the mounting frame using a retaining screw.

Use a 2-gang flush-mounted/appliance box (according to DIN 49073). Mounting on 1-gang flush-mounted/appliance boxes or surface-mounted boxes is not possible.

- Align the mounting frame (14) and screw it to the flush-mounted box or the wall . Observe marking TOP. Use the enclosed set of screws.
- Connect the KNX cable with connecting terminal to the terminal (8).
- Optional: Connect the external floor temperature/remote sensor to the terminal (7).
- ⓘ Programming button and LED are accessible only from the back of the device. If possible, load the physical address into the device before the final installation.
- Attach the device onto the mounting frame until it locks in place.
- Tighten the retaining screw (15) on the bottom of the mounting frame. Use a Pozi-Drive screwdriver, size 0.

Preparing the Glass sensor TS for mounting on a smooth substrate

The adhesive dots prevent the glass sensor from slipping when mounted on smooth surfaces.

- Free the adhesion points for the adhesive dots on the rear side of the glass sensor (13) from impurities (Figure 2).
- Remove the adhesive dots from the carrier film and stick them to the four adhesion points.
- Free the substrate of impurities.

- Before mounting the glass sensor, remove the protective film from the adhesive dots.
- i** Before completing mounting, align the glass sensor and press it in the area of the adhesive dots, in order to fix it in place.

Mounting and connecting the Glass sensor TS

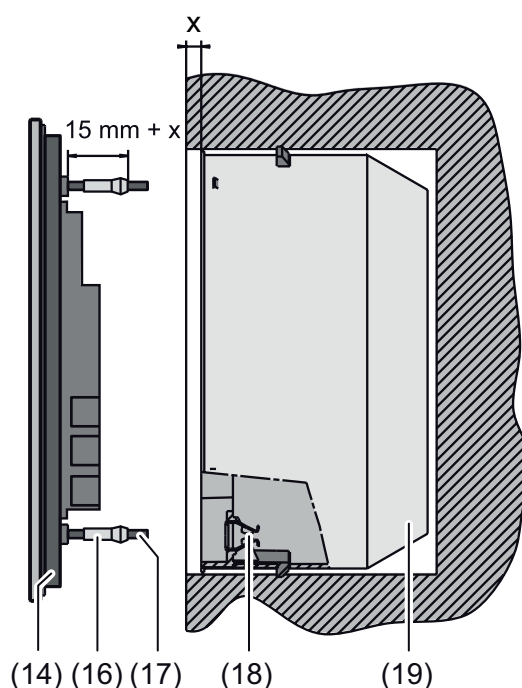

Figure 4: Device mounting of a TS Comfort glass sensor

- (14) Mounting frame
- (16) Retaining peg
- (17) Threaded pin
- (18) Friction spring
- (19) Appliance box for the TS glass sensor (accessory)

Use the appliance box for the 2-gang TS glass sensor (accessory). Mounting on 1-gang flush-mounted/appliance boxes or surface-mounted boxes is not possible.

Optional: For increased dismantling protection or to increase the shadow gap to the wall, use the enclosed mounting frame (14). For this, lock the mounting frame onto the device from behind. Observe marking TOP.

- If necessary, measure the surface compensation. With deeper installation sockets, adjusting the retaining pegs (16) on the threaded pins (17) allows a surface compensation of up to 20 mm. Unscrew the retaining pegs (16) by the surface compensation "x", so that they are at a distance of 15 mm + x from the socket for the threaded pins.
- i** When the mounting frame is used, the distance for the surface compensation is 20 mm + x from the socket for the threaded pins.
- Connect the KNX cable with connecting terminal to the terminal (8).
- Optional: Connect the external floor temperature/remote sensor to the terminal (7).
- i** Programming button and LED are accessible only from the back of the device. If possible, load the physical address into the device before the final installation.

- Insert the device with the threaded pins (17) into the friction springs (18) of the appliance box (19) and push it in until the retaining pegs noticeably lock into place.
- Align the device and push it in in the area of the retaining points to fix it.

Connecting and mounting the Glass sensor TS with increased dismantling protection

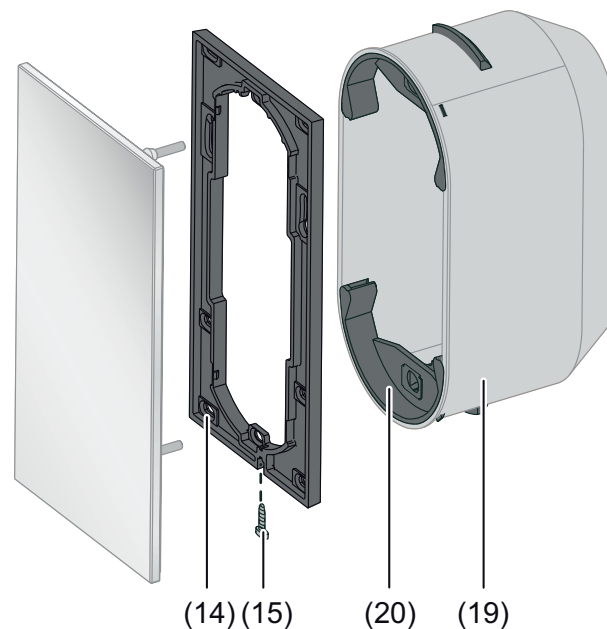

Figure 5: Device mounting of a TS Comfort glass sensor with increased dismantling protection

- (14) Mounting frame
- (15) Retaining screw
- (19) Appliance box for the TS glass sensor (accessory)
- (20) Friction spring seat

For increased dismantling protection, the mounting frame is firmly screwed to the appliance box or the wall and the device secured using a retaining screw on the bottom of the mounting frame.

- Lever the friction spring seats (20) out of the appliance box (19), in order to reveal the screw holes of the installation socket.
- Align the mounting frame and screw it to the appliance box of the wall. Observe marking TOP. Use the enclosed set of screws.
- Connect the KNX cable with connecting terminal to the terminal (8).
- Optional: Connect the external floor temperature/remote sensor to the terminal (7).
- ⓘ Programming button and LED are accessible only from the back of the device. If possible, load the physical address into the device before the final installation.
- Attach the device onto the mounting frame until it locks in place.
- Tighten the retaining screw (15) on the bottom of the mounting frame. Use a Pozi-Drive screwdriver, size 0.

Dismantling the Glass sensor TS

- If available, slacken the retaining screw (15) on the bottom edge. Use a Pozi-Drive screwdriver, size 0.
- Press the enclosed dismantling too in the centre of the glass sensor.
- Using the dismantling tool, pull the glass sensor evenly out of the anchoring - friction springs or mounting frame.
- Disconnect the connection cables.

2.4 Commissioning

Programming the physical address

The commissioning of the device is basically confined to programming of the physical address and the application data with the ETS.

Project planning and commissioning of the device using the ETS 3.0d with Patch A or newer versions.

The device is connected and ready for operation.

The rear side of the device must be accessible. Therefore, the device may not have been installed on the appliance box.

An appropriate device must be created and configured in the ETS project.

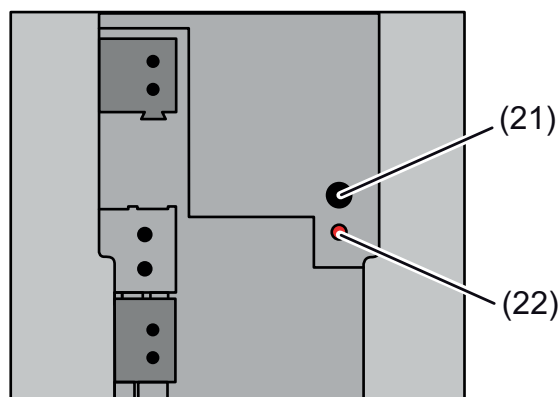

Figure 6: Programming buttons and LED on the rear side of the device

(21) Programming button

(22) Programming LED (red)

- Press the Programming button (21).
The programming LED (22) lights up and "**Pd**" is shown on the display. The device displays the programming status in this way.
 - Program the physical address with the help of the ETS.
The programming LED goes out.
 - Write the physical address on the device label.
 - Load the application data into the device using the ETS.
- i** When the physical address has been programmed, the device can finally be mounted.

2.5 Operation

The device consists of several sensor areas, which can be operated by touching them with your finger. With the sensor surfaces, a distinction is made between the display buttons (1) and the buttons of the push button sensor function (3) (Figure 1). The display buttons are located immediately to the left and right of the display and operate predefined functions of the integrated room temperature controller or the controller extension. In addition, these buttons can also be used to activate the Cleaning function to clean the glass surface.

The buttons beneath are allocated to the push button sensor function. The number of these buttons depends on the device variant. The push button sensor function is an independent function section of the device with its own parameter blocks in the ETS.

The reaction of the device when a sensor area of the push button sensor function is touched depends on the configuration in the ETS (see chapter 4.2.4.1.1. Operation concept and button evaluation).

The function of the display buttons depends on the ETS configuration of the integrated room temperature controller...

- Room temperature controller (main controller) switched on
The basic setpoint of the internal controller can be adjusted using the display buttons. In addition, the menu items of the second operation level, which affect the controller, can be opened and operated. In necessary, the cleaning function can also be activated. Access to the menu items in the second operating level using the display buttons is primarily dependent on the parameter settings of the second operating level and the controller mode in the ETS.
- Controller extension switched on:
The basic setpoint of an external controller can be adjusted using the display buttons. In the display, the setpoint shift is displayed as a relative value. In addition, it is possible to switch to the second operating level, in order to activate the Cleaning function as necessary. In the function as a controller extension, adjustment of additional parameters in the second operating level is not possible using the display buttons.
- Neither main controller not controller extension switched on:
It is only possible to switch to the second operating level using the display buttons, in order to activate the Cleaning function as necessary. Controller operation is not possible.

This chapter describes local operation of the display buttons for shifting the basic setpoint or to change various parameters of the integrated room temperature controller in the second operating level. In addition, it also explains how the cleaning function can be activated.

2.5.1 Basic display

During device operation, the basic display of the display can show up to four different display functions. This means that it is possible to display the time and day, or the setpoint temperature, the actual temperature (room temperature) or the external temperature (Figure 7). The information is shown separately on the display. It is possible to switch between the information automatically after set times or in controlled manner using a communication object. These properties, and the actually visible display information, are configured in the ETS before the device is commissioned (see chapter 4.2.4.6. Display).

There is no need to operate the device using the display buttons to switch the display information in the basic display.

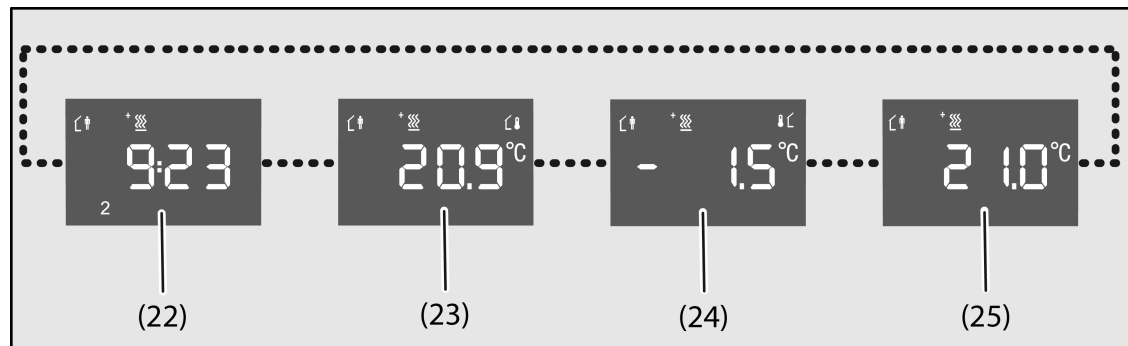

Figure 7: Possible display information of the basic display

(22) Time and day display

(23) Actual temperature display (lights up together with the icon $\leftarrow \downarrow$)

(24) External temperature display (lights up together with the icon $\downarrow \leftarrow$)

(25) Setpoint temperature display

If the left or right display button is actuated in the basic display, then the display for the basic setpoint shift is activated (see chapter 2.5.2. Basic setpoint shift).

2.5.2 Basic setpoint shift

The basic setpoint shift is used to make short-term or permanent changes to the setpoint temperature. It directly affects the basic setpoint configured in the ETS or specified by communication object of the same name.

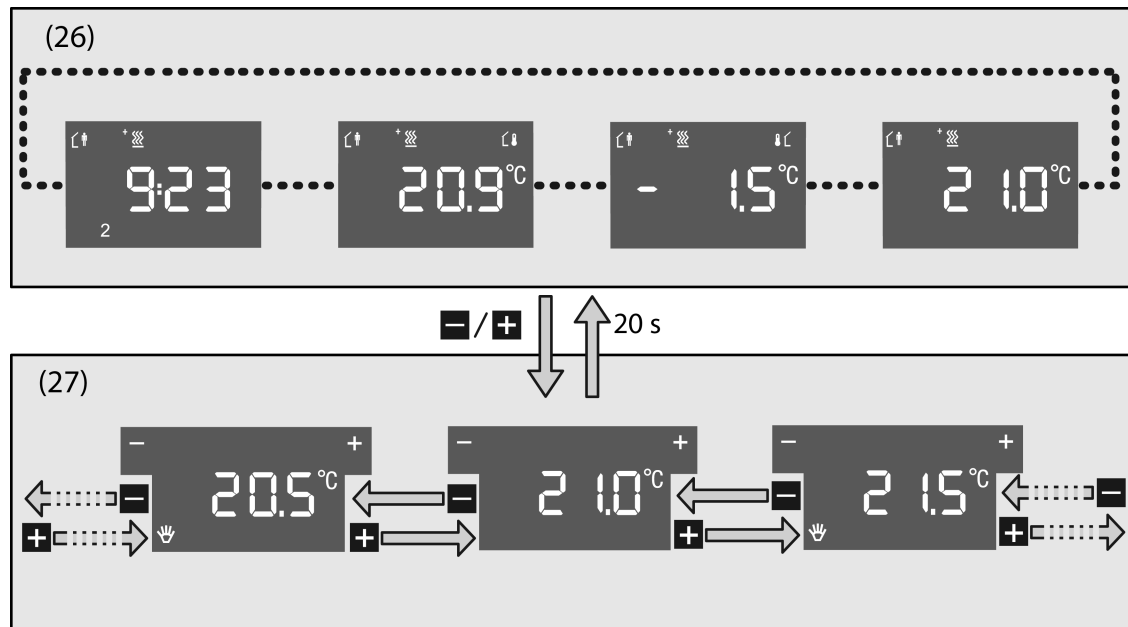

Figure 8: Basic setpoint shift using display buttons

(26) Basic display

(27) Display for setpoint value shift

⊕ Actuation of the right display button.

⊖ Actuation of the left display button.

20 s Automatic jump back after 20 s without further operation of the display buttons.

The basic display (26) is visible.

- Press the left or right display button.

The display shows the current setpoint temperature (27). Depending on the ETS configuration of the device, the display is either an absolute temperature value or a relative temperature value change.

- Reduce setpoint temperature: press the left display button ⊖.

- or -

- Increase setpoint temperature: press the right display button ⊕.

The setpoint temperature is adjusted in levels of 0.5 °C. A long button-press will continue the adjustment.

The 🖐 icon in the display shows that the setpoint temperature was adjusted.

The system returns to the basic display automatically after approx. 20 s has elapsed or when any sensor area of the push button sensor function section is pressed. The value adjusted using the display buttons is only then applied as the valid temperature value for the room temperature control.





- i** In addition to the shift of the basic setpoint using the display buttons, it is possible to use any function button of the push button sensor function section to carry out a shift. For this a function button should be configured to "Setpoint shift" in the ETS . In contrast to the setpoint shift using the display buttons, a long press of the function buttons does not permit continuous adjustment. In addition, the adjusted temperature values become valid immediately on each button press. This display of the setpoint shift always remains active for 20 s.
- i** Pressing both display buttons at the same time shows no reaction, if a basic setpoint shift was carried out using the display buttons before that and is still shown in the display. If the setpoint shift is executed using the function buttons of the push button sensor, or the basic display is active again, then pressing both display buttons at the same time opens the second operating level .
- i** Depending on the ETS configuration, a basic setpoint shift can only be temporarily active, or, alternatively, be applied permanently. With permanent application, the shift also maintains validity even after switchover the operating mode or the respecification of a basic setpoint using the communication object.
- i** The temperature range, settable with a basic setpoint shift, is defined in the ETS. It is possible to shift the current setpoint by a maximum of +/- 10 °C. It has to be considered that a shift of the displayed setpoint temperature (temperature offset of the basic temperature) will directly affect the basic setpoint and as a result shift all other temperature setpoints.
A positive shift is possible up to the configured heat protection temperature. A negative shift is possible up to the set frost protection temperature.
The setpoint temperatures of frost or heat protection mode cannot be shifted.
- i** The local basic setpoint shift on the device is not possible if neither the integrated room temperature controller nor the controller extension are switched on in the ETS.

2.5.3 Second operating level

Various settings of the integrated room temperature controlled can be made in the second operating level. In addition, the Cleaning function for cleaning the glass surface can be activated in this operating level.

The second operating level consists of a main menu and several submenus.

The menu is operated using the two display buttons. A distinction must be made between two different button operation concepts:

- On the one hand, the display buttons can be actuated individually. This either adjusts the values or changes the menu item. Display icons next to the buttons show which function is executed when the button is pressed. Value adjustment is made clear using the  and  icons, a change of the menu item using  and .
- On the other hand, both display buttons can be actuated together. This confirms settings, such as temperature value adjustments, and transfers them to the device memory.

If, in the second operating level, none of the display buttons is pressed for at least 20 s, then the second operating level is exited completely and the system automatically jumped back to the basic display. An exception to this is the Cleaning function, in which a return to the basic display only takes place after 60 s.

If a setting was changed before this and not yet confirmed, then the change is rejected on the automatic return and not applied. The same behaviour is achieved by pressing any button of the push button sensor function section.

Displaying the main menu

Additional submenus can be accessed from the main menu of the second operating level (Figure 9).

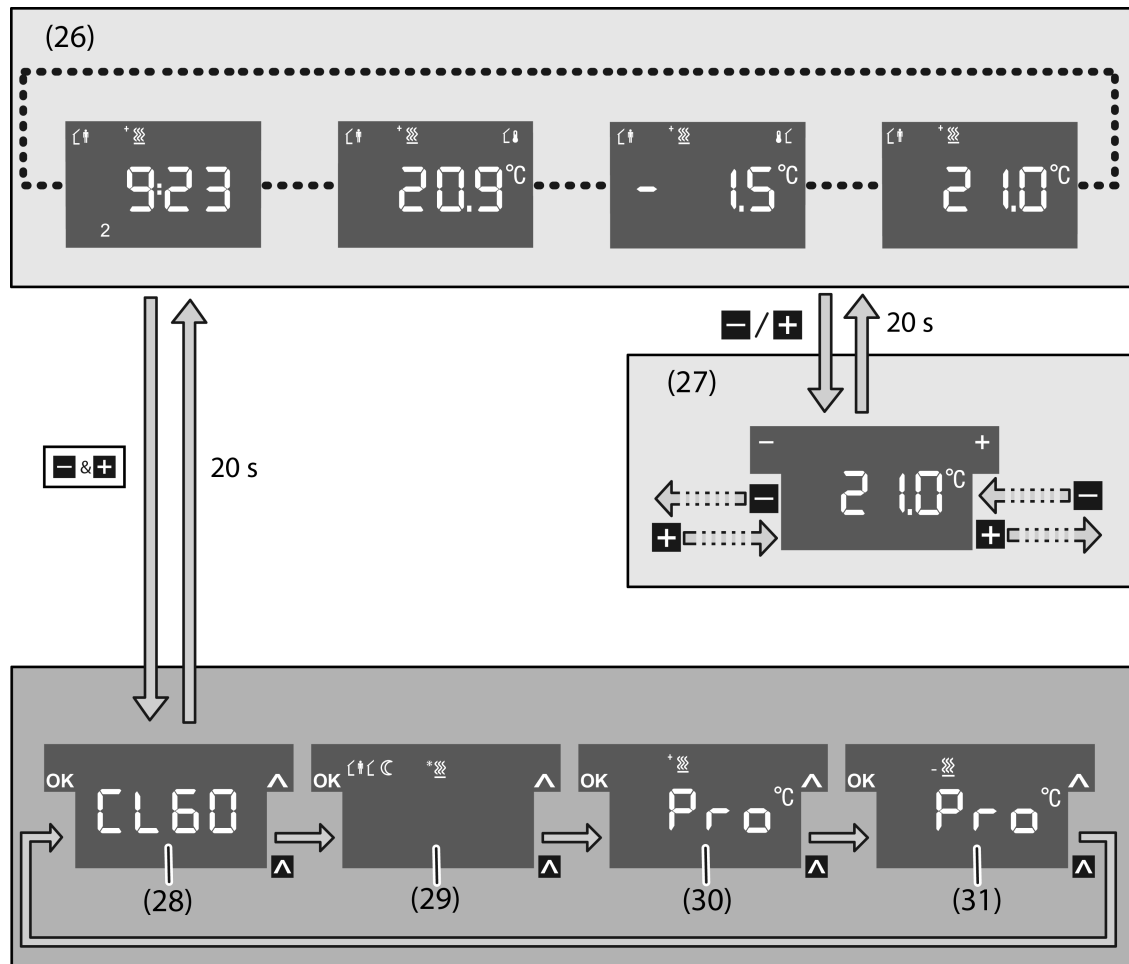

Figure 9: Main menu of the second operating level

- (27) Display for setpoint value shift
- (28) "Cleaning function" menu item
- (29) "Operating mode switch" menu item
- (30) "Heating mode temperature change" menu item
- (31) "Cooling mode temperature change" menu item

+/- Actuation of the right display button.

OK

OK Actuation of the left display button.

OK & +/- Simultaneous actuation of the left and right display button.

+

20 s Automatic jump back after 20 s without further operation of the display buttons.

The basic display (26) is visible.

- At the same time, press the display buttons **+/-** and **OK** simultaneously for at least 3 s. The main menu of the second operating level is opened. The display shows the first menu item **CL60**.
- Pressing the display button **OK** opens the additional menu items in sequence.

i Pressing the left display button **OK** in the main menu opens the submenus, depending on the selected menu item.

- i** In the ETS, it is possible to hide the menu items "Operating mode" (29) and "Temperature change" (30) & (31). In this case, the menu items of the main menu are invisible. The menu item "Cleaning function" is always visible and can be selected, even if the room temperature controller or controller extension are deactivated.

Cleaning the glass surface

Activating the Cleaning function blocks the sensor area evaluation for 60 s to prevent unintentional actions from being executed when the glass surface is being cleaned.

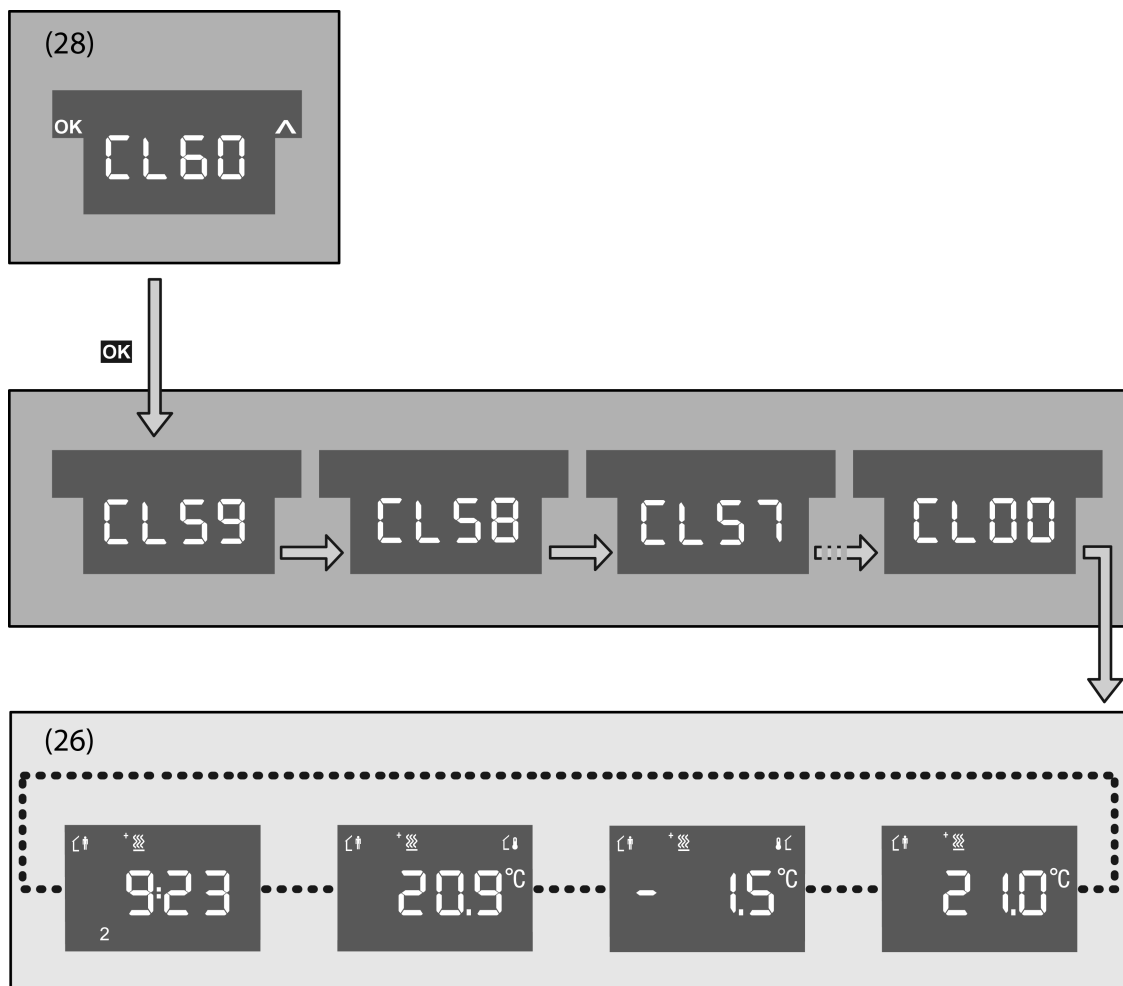

Figure 10: Submenu of the cleaning function

(26) Basic display

(28) "Cleaning function" menu item in the main menu of the second operating level

OK Actuation of the left display button

The main menu of the second operating level is displayed.

- Press the right display button **▲** to select the menu item **CL60** (28) for the Cleaning function, assuming that this menu item has not already been selected (Figure 10).
- Press the left display button **OK**.
All the sensor areas on the device are blocked for 60 s.
All the status LEDs flash.

The display shows the time remaining until the end of the Cleaning function.

After 60 s, the device automatically reverts to the basic display (26). The block has been removed and normal operation is possible again.

- i** Cleaning with a lightly moistened, lint-free cloth, possibly with a mild glass cleaner. Do not use sharp objects or abrasive cleaning agents, e.g. scouring powder.
- i** The Cleaning function can always be executed, even if the room temperature controller or controller extension are deactivated in the ETS.

Setting the operating mode

In the second operating level of the device, the operating mode of the integrated room temperature controller can be switched, influencing the setpoint temperature.

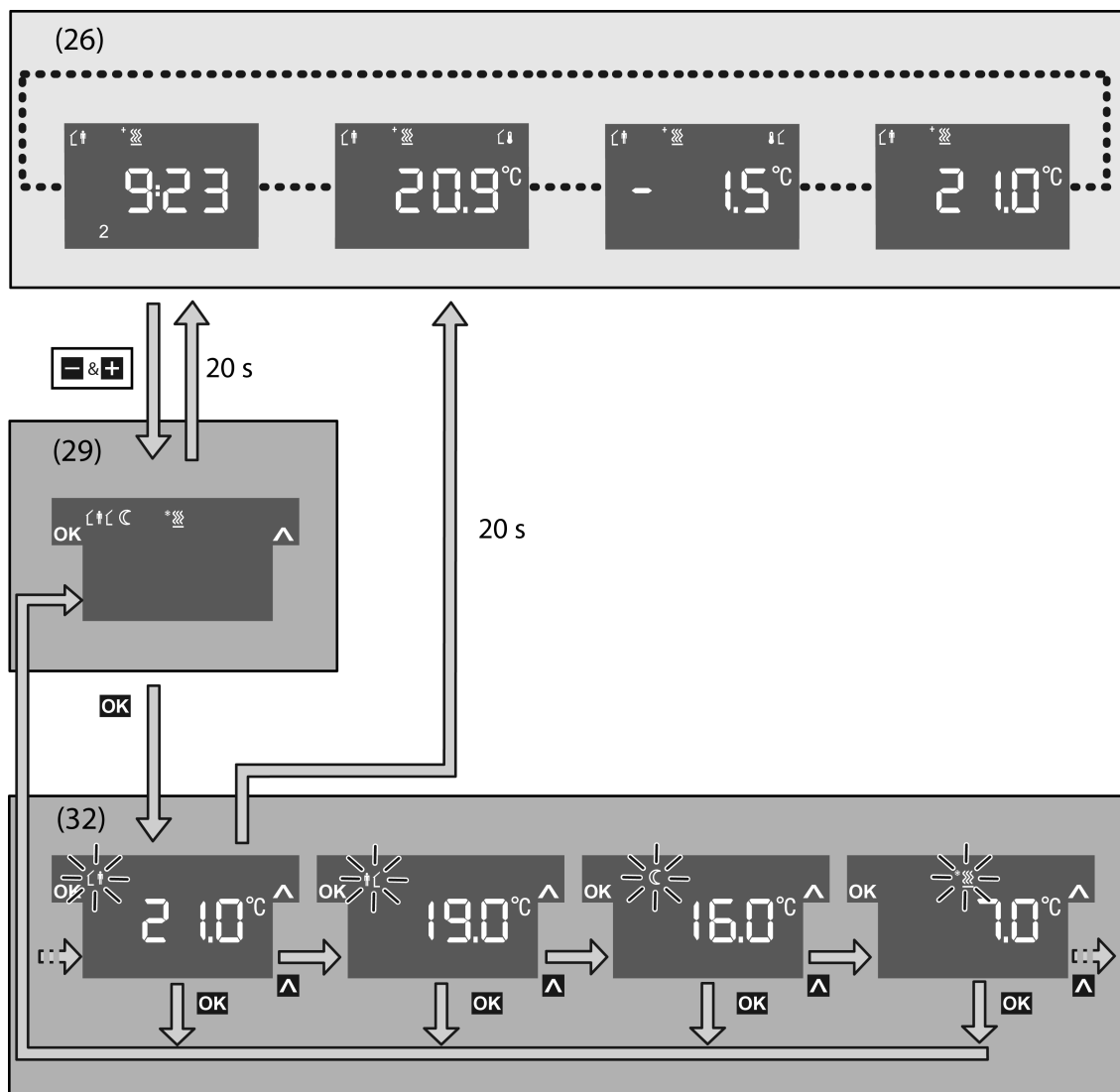

Figure 11: Submenu for operating mode selection

(26) Basic display

(29) "Operating mode switch" menu item in the main menu of the second operating level

(32) "Operating mode selection" submenu

 Actuation of the right display button.

 Actuation of the left display button.

 Simultaneous actuation of the left and right display button.



20 s Automatic jump back after 20 s without further operation of the display buttons.

The main menu of the second operating level is displayed.

- Using the right display button , select the menu item for the operating mode switch (29) (Figure 11).

 In the ETS, it is possible to hide the menu item "Operating mode switch" (29). In this case, the menu item in the main menu is invisible.

- Press the left display button .

The submenu "Operating mode switch" (32) is shown and the active operating mode is displayed with its setpoint temperature (without taking a basic setpoint shift into account). The corresponding display icon flashes.

- Press the right display button  to select the required operating mode.

- Press the left display button .

The setting is saved.

The display switches back to the main menu of the second operating level (29).

The setpoint temperature for the room is set according to the new operating mode.

 If the device is working as a controller extension, then it is not possible to switch the operating mode in the second operating level.

Activating comfort extension

With automatic changeover of the operating modes, e.g. by an external timer, it is nevertheless possible to retain the comfort mode for some time. This is made possible by the comfort extension (see chapter 4.2.4.2.4. Operating mode switchover). The comfort extension is restricted to a certain period of time.

The device is in the operating mode Night  or Frost/heat protection .

A presence button is planned on the device in the ETS or additional bus devices available in the KNX/EIB installation, which have a presence button (e.g. controller extensions) and connected to the local device using group addresses.

- Press the presence button.

The display shows the icons  or .

The comfort extension is active for the time set in the ETS.

Once the programmed time expires, the original operating mode Night or Frost/heat protection is restored.

Changing setpoint temperatures

In the second operating level of the device, it is possible to change the setpoint temperatures for the Comfort, Standby and Night modes separately for heating and cooling.

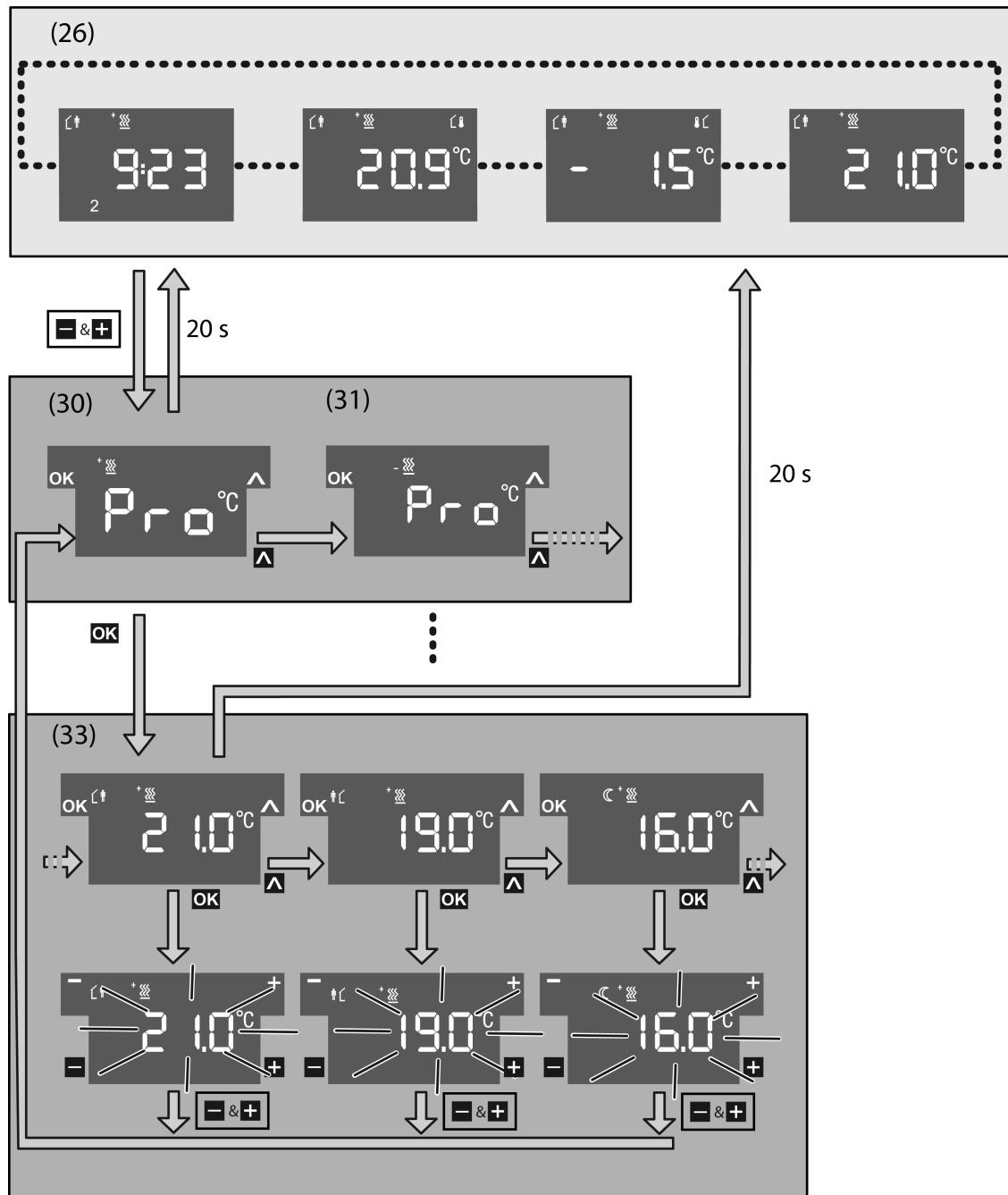

Figure 12: Submenu for changing the setpoint temperatures

(26) Basic display

(30) "Heating mode temperature change" menu item

(31) "Cooling mode temperature change" menu item

(33) "Temperature change" submenu

+/- / Actuation of the right display button.

▲

◀ / Actuation of the left display button.

OK

◀&+ Simultaneous actuation of the left and right display button.

+

20 s Automatic jump back after 20 s without further operation of the display buttons.

The main menu of the second operating level is displayed.

- Using the right display button **▲**, select the menu item for the temperature change of heating mode (30) or cooling mode (31) (Figure 12).
- i** The operation of the "Heating mode temperature change" and "Cooling mode temperature change" menus is identical. Therefore, the following section will only deal with menu operation using the example of the "Heating mode temperature change" menu.
- i** In the ETS, it is possible to hide the menu items "Heating mode temperature change" and "Cooling mode temperature change". In this case, both menu items of the main menu are invisible.
- Press the left display button **OK**.
The "Temperature change" submenu (33) is shown and the setpoint temperature of the Comfort mode displayed.
- Press the right display button **▲** to select the required operating mode.
- Press the left display button **OK**.
The setpoint temperature flashes.
- Reduce setpoint temperature: press the left display button **■**.
- or -
- Increase setpoint temperature: press the right display button **+**.
- i** The setpoint temperatures for Standby and Night modes are adjusted in levels of 0.5 °C. The setpoint temperature for Comfort mode (basic setpoint) is adjusted in levels of 1 °C. The deadband shift (Cooling comfort temperature in the "Heating and cooling" mode) takes place in levels of 0.5 °C.
- Apply changes: press the **+** and **■** sensor buttons simultaneously.
The set setpoint temperature for the set operating mode is saved.
The display switches back to the main menu of the second operating level (30) or (31). The operating mode active before the setting remains intact and is not changed by changing the setpoint temperature of another operating mode.
- or -
- Do not apply change: press any sensor button of the push button sensor function (3) or (4).
The set setpoint temperature for the set operating mode is not saved.
The display switches back to the main menu of the second operating level (30) or (31). The last operating mode before the setting remains intact.
- i** If the setpoint temperature should be changed for other operating modes, repeat the described operating levels.
- i** It is possible in the ETS to block the setting of the individual temperature values for heating and cooling. In this case the individual temperature values are visible but cannot however be adjusted.

- i** When changing the setpoint temperatures in the second operating level, it should be noted that all the temperature values of the controller are derived from the basic setpoint (see chapter 4.2.4.2.5. Temperature setpoints). When adjusting the basic setpoint, all the other setpoint temperature values (Standby, Night) are also changed - also for cooling operation. The basic setpoint is set directly in the individual operating modes "Heating" or "Cooling" using the appropriate comfort temperature. In the combined operating mode "Heating and cooling", the basic setpoint is set either directly (asymmetrical deadband) or indirectly (symmetrical deadband) using the comfort temperature for heating according to the deadband positions configured in the ETS.
- In the combined operating mode "Heating and cooling" the setpoint temperatures for cooling mode can be derived from the comfort setpoint temperature of heating mode while taking the deadband into account. Adjusting the comfort setpoint temperature for cooling mode in the second operating level affects the size of the deadband. With an asymmetrical deadband position, only the temperature values for cooling mode are shifted. With a symmetrical deadband position, the setpoint temperatures of the heating mode are also shifted.
- i** Changes to the comfort temperature for heating (= change of the basic setpoint) in the second operating level are only applied internally to the device. The transmission of a new temperature value via the "Basic setpoint" object does not take place after a local change on the device. If the basic setpoint is changed, then only a new setpoint temperature is transmitted to the bus using the communication object of the same name.

3 Technical data

General

Degree of protection	IP 20
Protection class	III
Mark of approval	KNX/EIB
Ambient temperature	-5 ... +45 °C
Storage/transport temperature	-25 ... +70 °C

KNX/EIB supply

KNX medium	TP 1
Commissioning mode	S-mode
Rated voltage KNX	DC 21 ... 32 V SELV
Power consumption KNX	typical 150 mW
Connection mode KNX	Connection terminal

Additional power supply

Rated voltage	DC 18 ... 32 V SELV
Power consumption	max. 0.5 W

Internal clock

Resolution, clock	1 min
Rate deviation	max. 8 min/day

Internal temperature sensor

Measuring range	0°C ...+40°C ±1%
Resolution	0.1 K
Relative humidity	0 ... 95 % (No moisture condensation)

Floor temperature/remote sensor input

Type	Floor temperature/remote sensor (accessories)
------	---

4 Software description

4.1 Software specification

ETS search paths:	Push button / Push button 2gang / Glass sensor 2gang with RTR and display
	Push button / Push button 3gang / Glass sensor 3gang with RTR and display
BAU used:	TP-UART + μ C
KNX/EIB type class:	3b device with cert. Physical layer + stack
Configuration:	S-mode standard
PEI type:	"00" _{Hex} / "0" _{Dec}
PEI connector:	no connector

Application for 2-gang glass sensor:

No.	Short description	Name	Version	from mask version
1	Multifunctional room temperature controller / pushbutton sensor application: Up to four sensor areas for the push button sensor function. Two sensor areas for operating the display. Version 1.2 replaces version 1.1 completely.	Glass sensor 2gang with RTR 16B212	1.2 for ETS3.0 Version d onwards	705

Application for 3-gang glass sensor:

No.	Short description	Name	Version	from mask version
1	Multifunctional room temperature controller / pushbutton sensor application: Up to six sensor areas for the push button sensor function. Two sensor areas for operating the display.. Version 1.2 replaces version 1.1 completely.	Glass sensor 3gang with RTR 16B312	1.2 for ETS3.0 Version d onwards	705

4.2 Software "Glass sensor x with RTR 16Bx11/16Bx12"

4.2.1 Scope of functions

General functions

- The operation LED can be permanently on or off or alternatively be switched via a communication object.
- Internal clock to display the time and weekday on the device display. The time information is made available to the device using a communication object (e.g. by a KNX/EIB timer switch). Automatic time request possible after a device restart.
- LED display with switchable backlighting. On the display, icons signal various operating states of the integrated room temperature controller or the controller extension. In addition, up to four display functions (time, actual temperature, setpoint temperature, external temperature) can be shown on the display either alternating over time or controlled by a communication object.
- Integrated scene control. Internal storage of up to eight scenes with eight output channels, recall of internal scenes by means of a presettable scene number, selection of object types for the output channels; for each scene, the storage of the individual output values and the transmission of the output values can be permitted or inhibited; the individual channels can be delayed during scene recall; as scene extension, 64 scenes can be recalled and stored.

Functions of the integrated push button sensor

- Selectable evaluation of a sensor area as a button or evaluation of two neighbouring sensor areas as a rocker.
- Each rocker can be used for the functions 'switching', 'dimming', 'Venetian blind', '1 byte value transmitter', '2-byte value transmitter', 'scene extension' and '2-channel operation'.
- Each button can be used for the functions 'switching', 'dimming', 'Venetian blind', '1 byte value transmitter', '2-byte value transmitter', 'scene extension' and '2-channel operation', 'controller extension', 'fan controller', 'controller operating mode' and 'setpoint shift'. The 'fan controller', 'controller operating mode' and 'setpoint shift' functions are used to operate the integrated room temperature controller.
- 2-channel operating function: each rocker or each button can be set for controlling two independent channels. This means that only one button-press is enough to transmit up to two telegrams to the bus. The channels can be configured independently of one another for the Switching, Value transmitter (1 byte) or Temperature value transmitter (2 bytes) functions.
- For the rocker functions Dimming, Venetian blind (operation concept "Long – Short or Short") and 2-channel operation, full-surface rocker actuation can also be evaluated. With full-surface rocker operation, switching telegrams and scene recall requests can be triggered on the bus in addition to and independently of the configured rocker function.
- The switching function permits the following settings: reaction after pressing and/or releasing, switch on, switch off, and toggle.
- The dimming function permits the following settings: times for short and long actuation, dimming in different levels, telegram repetition on long press, transmission of stop telegram after end of press.
- The shutter control permits the following settings: four different operation concepts with times for short and long press and slat adjustment.
- The 1-byte and 2-byte value transmitter function permits the following settings: selection of the value range (0 ... 100 %, 0 ... 255, 0 ... 65535, 0 ... 1500 lux, 0 ... 40 °C), value on button-press, value change on sustained button-press with different step widths, optional overflow on reaching the end of a value range.
- The controller extension function permits the following settings to operate an external room temperature controller: operating mode change-over with normal and high priority, defined selection of an operating mode, change between different operating modes, change of presence status, setpoint shift.
- There is as status LED available for each sensor area. When a status LED is internally connected with the rocker or the button, it can signal a button-press or the current status of a communication object. The status indication can also be in inverted form. When a status LED is not dependent on the rocker or button, it can be permanently on or off, indicate the status of an independent communication object, the operating state of a room temperature controller or the result of a comparison between signed or unsigned 1 byte values.

- The rockers or buttons can be disabled via a 1-bit object. The following settings are possible: polarity of the disabling object, behaviour at the beginning and at the end of disabling. During an active disable, all or some of the rockers / buttons can have no function, can perform the function of a selected button or execute one of two presettable disabling functions.
- A delay to the automatically transmitted communication objects of the controller external after a device reset can be configured. The delay time is automatically produced by the subscriber address (physical address).
- All LEDs of the push button sensor can flash simultaneously in the event of an alarm. The following settings are possible: Value of alarm signalling object for the states alarm / no alarm, alarm acknowledge by actuation of a button, transmission of the acknowledge signal to other devices.

Functions of the integrated room temperature controller

- Various operating modes can be activated: Comfort, Standby, Night and Frost/heat protection
- Each operating mode can be assigned its own temperature-setpoints (for heating and/or cooling).
- Comfort extension possible using presence button in Night or Frost/heat protection mode. Configurable duration of the comfort extension.
- Operating mode change-over via 1-byte object according to KONNEX or using up to four individual 1-bit objects.
- Frost/heat protection change-over via window status.
- Display of room temperature regulator information via the device display
- Display buttons to operate the controller (setpoint shift and second operating level to change the operating mode of the setpoint temperatures).
- Operating modes "Heating", "Cooling", "Heating and cooling" each with or without additional level.
- Various control types can be configured for each heating or cooling level: PI control (permanent or switching PWM) or 2-point feedback control (switching).
- Control parameter for PI controller (if desired: proportional range, reset time) and 2-point controller (hysteresis) adjustable.
- The temperature setpoints for the additional level are derived via a configurable level offset from the values of the basic level.
- Automatic or object oriented switch-over between "heating" and "cooling".
- Temporary setpoint shifting or permanent setpoint shifting through operation of the display buttons on the device or via communication objects possible (e.g. using a controller extension). Display of the setpoint offset in the device display either absolute (discrete temperature value) or relative (positive or negative temperature shift).
- Complete (1-byte) or partial (1-bit) status information configurable and transmissible on the bus via objects.
- Deactivating the feedback control or the additional level possible using separate 1-bit objects.
- Internal and external temperature sensor for room temperature measurement possible.
- Configurable internal to external determination of measured value and enabled external sensor for room temperature measurement. Settable polling time of the external temperature sensor.
- Optional connection of a wired temperature/remote sensor on the rear side of the device. It is possible to choose whether the temperature/remote sensor is used for room temperature measurement or for a floor temperature limit (only in heating mode).
- The room temperature measurement (actual value) can be adjusted separately for the internal and external sensor using parameters.
- The actual and setpoint temperatures can be output on the bus if a configurable deviation is detected (also periodically).
- Separate or shared command value output in heating and cooling mode. This produces one or two command value objects for each level.
- Normal or inverted command value output configurable
- Automatic transmission and cycle-time for actuating output parameterizable

- Floor temperature limit possible in heating mode. Thus temperature-controlled switch-off of a floor heater as protective function.
- Setpoint temperature limit possible in cooling mode. If necessary, the controller limits the setpoint temperature to specific values and prevents an adjustment beyond statutory limits.

Functions of the integrated controller extension

- Alternatively to the function of the room temperature controller, the extension mode can be activated. This allows control of an external room temperature controller.
- Full control of the controller (operating modes, presence functions and setpoint shift).
- Full-featured indication of the controller status on the display of the extension (heating / cooling reporting, setpoint shift, room temperature, setpoint temperature and current operating mode).
- Room temperature measurement also possible on the extension.

4.2.2 Notes on software

ETS project design and commissioning

For configuration and commissioning of the device, at least ETS3.0d with Patch A is required. Advantages with regard to downloading (significantly shorter loading times) and parameter programming using the integrated database plug-in can be expected only if this ETS patch version or later versions are used.

The necessary product database is offered in the *.VD4 format. No product database is available for ETS2 and older versions of ETS3.

4.2.3 Object table

4.2.3.1 Object table, push button sensor function section

Number of communication objects:	78 (2x variant) 84 (3x variant) (max. object number 135 - gaps in between)
Number of addresses (max):	254
Number of assignments (max):	255
Dynamic table management	yes
Maximum table length	509

Objects for rocker or push-button function (pushbutton sensor function section)

Function: Switching

Object	Function	Name	Type	DPT	Flag
 ²	Switching	B.rocker/B.button _{1 1,2}	1-bit	1.xxx	C, W, T, (R) ³

Description 1-bit object for transmission of switching telegrams (ON, OFF).

Function: Dimming

Object	Function	Name	Type	DPT	Flag
 ²	Switching	B.rocker/B.button _{1 1,2}	1-bit	1.xxx	C, W, T, (R) ³

Description 1-bit object for transmission of switching telegrams (ON, OFF).

Function: Dimming

Object	Function	Name	Type	DPT	Flag
 ²⁰	Dimming	B.rocker/B.button _{1 1,2}	4-bit	3.007	C, W, T, (R) ³

Description 4-bit object for the transmission of relative dimming telegrams.

Function: Venetian blind

Object	Function	Name	Type	DPT	Flag
 ²	Short time operation	B.rocker/B.button _{1 1,2}	1-bit	1.007	C, -, T, (R) ₃

Description 1-bit object for the transmission of telegrams with which a Venetian blind or shutter drive motor can be stopped or with which the blind slats can be adjusted by short time operation.

1: The number of rockers or buttons depends on the planned device variant.

2: The objects have been described for rocker 1 or button 1 as an example. The objects for the other rockers/buttons and for the module rockers are defined in the same way by shifting the object number and changing the object name.

3: For reading, the R-flag must be set. The last value written to the object via the bus will be read.

Function: Venetian blind

Object	Function	Name	Type	DPT	Flag
 ²⁰	Long-time operation	B.rocker/B.button _{1 1,2}	1-bit	1.008	C, W, T, (R) ³

Description 1-bit object for the transmission of telegrams with which a Venetian blind or shutter drive motor can be moved upwards or downwards.

Function: 1-byte value transmitter

Object	Function	Name	Type	DPT	Flag
 ²	Value	B.rocker/B.button _{1 1,2}	1 byte	5.xxx	C, W, T, (R) ³

Description 1-byte object for the transmission of values from 0 to 255 (corresponding to values from 0 % to 100 %). If the adjustment of the value is enabled, the object can transmit telegrams cyclically after long actuation with which the value can be reduced or increased by a presettable amount.

Function: 2-byte value transmitter

Object	Function	Name	Type	DPT	Flag
 ²	Value	B.rocker/B.button _{1 1,2}	2 byte	7.xxx	C, W, T, (R) ³

Description 2-byte object for the transmission of values from 0 to 65535. If the adjustment of the value is enabled, the object can transmit cyclical telegrams after a long press with which the value can be reduced or increased by an adjustable amount.

Function: 2-byte value transmitter

Object	Function	Name	Type	DPT	Flag
 ²	Temperature value	B.rocker/B.button _{1 1,2}	2 byte	9.001	C, W, T, (R) ³

Description 2 -byte object for the transmission of a temperature value from 0 °C to 40 °C. If the adjustment of the value is enabled, the object can transmit telegrams cyclically after a long press with which the value can be reduced or increased by 1 K.

1: The number of rockers or buttons depends on the planned device variant.

2: The objects have been described for rocker 1 or button 1 as an example. The objects for the other rockers/buttons and for the module rockers are defined in the same way by shifting the object number and changing the object name.

3: For reading, the R-flag must be set. The last value written to the object via the bus will be read.

Function: 2-byte value transmitter

Object	Function	Name	Type	DPT	Flag
 ²	Brightness value	B.rocker/B.button _{1 1,2}	2 byte	9.004	C, W, T, (R) ³

Description 2-byte object for the transmission of a brightness level value from 0 to 1500 lux. If the adjustment of the value is enabled, the object can transmit cyclical telegrams after a long press with which the value can be reduced or increased by 50 lux.

Function: Scene extension

Object	Function	Name	Type	DPT	Flag
 ²	Scene extension	B.rocker/B.button _{1 1,2}	1 byte	18.001	C, -, T, (R) ₃

Description 1-byte object for recalling or for storing one of 64 scenes max. from a scene push button sensor.

Function: 2-channel operation

Object	Function	Name	Type	DPT	Flag
 ²	Channel 1 switching	B.rocker/B.button _{1 1,2}	1-bit	1.xxx	C, W, T, (R) ³

Description 1-bit object for the transmission of switching telegrams, if 2-channel operation is activated.

Function: 2-channel operation

Object	Function	Name	Type	DPT	Flag
 ²	Channel 1 value	B.rocker/B.button _{1 1,2}	1 byte	5.xxx	C, -, T, (R) ₃

Description 1-byte object for the transmission of value telegrams, if 2-channel operation is activated.

Function: 2-channel operation

Object	Function	Name	Type	DPT	Flag
 ²	Channel 1 value	B.rocker/B.button _{1 1,2}	2 byte	9.001	C, -, T, (R) ₃

Description 2-byte object for the transmission of value telegrams, if 2-channel operation is activated.

1: The number of rockers or buttons depends on the planned device variant.

2: The objects have been described for rocker 1 or button 1 as an example. The objects for the other rockers/buttons and for the module rockers are defined in the same way by shifting the object number and changing the object name.

3: For reading, the R-flag must be set. The last value written to the object via the bus will be read.

Function: 2-channel operation

Object	Function	Name	Type	DPT	Flag
 ²⁰	Channel 2 switching	B.rocker/B.button 1 ^{1,2}	1-bit	1.xxx	C, W, T, (R) ³

Description 1-bit object for the transmission of switching telegrams, if 2-channel operation is activated.

Function: 2-channel operation

Object	Function	Name	Type	DPT	Flag
 ²⁰	Channel 2 value	B.rocker/B.button 1 ^{1,2}	1 byte	5.xxx	C, -, T, (R) 3

Description 1-byte object for the transmission of value telegrams, if 2-channel operation is activated.

Function: 2-channel operation

Object	Function	Name	Type	DPT	Flag
 ²⁰	Channel 2 value	B.rocker/B.button 1 ^{1,2}	2 byte	9.001	C, -, T, (R) 3

Description 2-byte object for the transmission of value telegrams, if 2-channel operation is activated.

Objects for full-surface operation with rocker function (for dimming, Venetian blind and 2-channel operation)

Function: Full-surface operation

Object	Function	Name	Type	DPT	Flag
 ³	Switching	B.rocker 1 full-surface actuation ^{1,2}	1-bit	1.xxx	C, W, T, (R) ³

Description 1-bit object for the transmission of switching telegrams (ON, OFF) for full-surface operation of a sensor area.

1: The number of rockers or buttons depends on the planned device variant.

2: The objects have been described for rocker 1 or button 1 as an example. The objects for the other rockers/buttons and for the module rockers are defined in the same way by shifting the object number and changing the object name.

3: For reading, the R-flag must be set. The last value written to the object via the bus will be read.

Function: Full-surface operation

Object	Function	Name	Type	DPT	Flag
 ³	Scene extension	B.rocker 1 full-surface actuation ^{1,2}	1 byte	18.001	C, -, T, (R) ₃

Description 1-byte object for recalling or for storing one of 64 scenes max. from a scene pushbutton sensor for full-surface operation of a sensor area.

Objects for status LED

Function: Status LED in case of rocker function

Object	Function	Name	Type	DPT	Flag
 ³⁸	Status LED left	B.Rocker 1 ^{1,2}	1-bit	1.xxx	C, W, -, (R) ₃

Description 1-bit object for activation of the status LED.

Function: Status LED in case of rocker function

Object	Function	Name	Type	DPT	Flag
 ³⁸	Status LED left	B.rocker 1 ^{1,2}	1 byte	5.xxx, 6.xxx, 20.102	C, W, -, (R) ₃

Description 1-byte object for activation of the status LED.

Function: Status LED in case of rocker function

Object	Function	Name	Type	DPT	Flag
 ³⁹	Status LED right	B.rocker 1 ^{1,2}	1-bit	1.xxx	C, W, -, (R) ₃

Description 1-bit object for activation of the status LED.

Function: Status LED in case of rocker function

Object	Function	Name	Type	DPT	Flag
 ³⁹	Status LED right	B.rocker 1 ^{1,2}	1 byte	5.xxx, 6.xxx, 20.102	C, W, -, (R) ₃

Description 1-byte object for activation of the status LED.

1: The number of rockers or buttons depends on the planned device variant.

2: The objects have been described for rocker 1 or button 1 as an example. The objects for the other rockers/buttons and for the module rockers are defined in the same way by shifting the object number and changing the object name.

3: For reading, the R-flag must be set. The last value written to the object via the bus will be read.

Function: Status LED in case of push button function

Object	Function	Name	Type	DPT	Flag
 ³⁸	Status LED	B.button 1 ^{1,2}	1-bit	1.xxx	C, W, -, (R) ₃

Description 1-bit object for activation of the status LED.

Function: Status LED in case of push button function

Object	Function	Name	Type	DPT	Flag
 ³⁸	Status LED	B.button 1 ^{1,2}	1 byte	5.xxx, 6.xxx, 20.102	C, W, -, (R) ₃

Description 1-byte object for activation of the status LED.

Objects for disabling functions (pushbutton sensor function section)

Function: Switching

Object	Function	Name	Type	DPT	Flag
 ^{16, 17}	Switching	B.Disabling function 1 / 2	1-bit	1.xxx	C, W, T, (R) ³

Description 1-bit object for transmission of switching telegrams (ON, OFF).

Function: Dimming

Object	Function	Name	Type	DPT	Flag
 ^{16, 17}	Switching	B.Disabling function 1 / 2	1-bit	1.xxx	C, W, T, (R) ³

Description 1-bit object for transmission of switching telegrams (ON, OFF).

Function: Dimming

Object	Function	Name	Type	DPT	Flag
 ^{34, 35}	Dimming	B.Disabling function 1 / 2	4-bit	1.007	C, W, T, (R) ³

Description 4-bit object for the transmission of relative dimming telegrams.

1: The number of rockers or buttons depends on the planned device variant.

2: The objects have been described for rocker 1 or button 1 as an example. The objects for the other rockers/buttons and for the module rockers are defined in the same way by shifting the object number and changing the object name.

3: For reading, the R-flag must be set. The last value written to the object via the bus will be read.

Function: Venetian blind

Object	Function	Name	Type	DPT	Flag
 16, 17	Short time operation	B.Disabling function 1 / 2	1-bit	1.007	C, -, T, (R) 1

Description 1-bit object for the transmission of telegrams with which a Venetian blind or shutter drive motor can be stopped or with which the blind slats can be adjusted by short time operation.

Function: Venetian blind

Object	Function	Name	Type	DPT	Flag
 34, 35	Long-time operation	B.Disabling function 1 / 2	1-bit	1.008	C, W, T, (R) 1

Description 1-bit object for the transmission of telegrams with which a Venetian blind or shutter drive motor can be can be moved upwards or downwards.

Function: 1-byte value transmitter

Object	Function	Name	Type	DPT	Flag
 16, 17	Value	B.Disabling function 1 / 2	1 byte	5.xxx	C, W, T, (R) 1

Description 1-byte object for the transmission of values from 0 to 255 (corresponding to values from 0 % to 100 %). If the adjustment of the value is enabled, the object can transmit telegrams cyclically after long actuation with which the value can be reduced or increased by a presettable amount.

Function: 2-byte value transmitter

Object	Function	Name	Type	DPT	Flag
 16, 17	Value	B.Disabling function 1 / 2	2 byte	7.xxx	C, W, T, (R) 1

Description 2-byte object for the transmission of values from 0 to 65535. If the adjustment of the value is enabled, the object can transmit cyclical telegrams after a long press with which the value can be reduced or increased by an adjustable amount.

Function: 2-byte value transmitter

Object	Function	Name	Type	DPT	Flag
 16, 17	Temperature value	B.Disabling function 1 / 2	2 byte	9.001	C, W, T, (R) 1

Description 2 -byte object for the transmission of a temperature value from 0 °C to 40 °C. If the adjustment of the value is enabled, the object can transmit telegrams cyclically after a long press with which the value can be reduced or increased by 1 K.

1: For reading, the R-flag must be set. The last value written to the object via the bus will be read.

Function: 2-byte value transmitter

Object	Function	Name	Type	DPT	Flag
 16, 17	Brightness value	B.Disabling function 1 / 2	2 byte	9.004	C, W, T, (R) ¹

Description 2-byte object for the transmission of a brightness level value from 0 to 1500 lux. If the adjustment of the value is enabled, the object can transmit cyclical telegrams after a long press with which the value can be reduced or increased by 50 lux.

Function: Scene extension

Object	Function	Name	Type	DPT	Flag
 16, 17	Scene extension	B.Disabling function 1 / 2	1 byte	18.001	C, -, T, (R) 1

Description 1-byte object for recalling or for storing one of 64 scenes max. from a scene push button sensor.

Function: 2-channel operation

Object	Function	Name	Type	DPT	Flag
 16, 17	Channel 1 switching	B.Disabling function 1 / 2	1-bit	1.xxx	C, W, T, (R) ¹

Description 1-bit object for the transmission of switching telegrams, if 2-channel operation is activated.

Function: 2-channel operation

Object	Function	Name	Type	DPT	Flag
 16, 17	Channel 1 value	B.Disabling function 1 / 2	1 byte	5.xxx	C, -, T, (R) 1

Description 1-byte object for the transmission of value telegrams, if 2-channel operation is activated.

Function: 2-channel operation

Object	Function	Name	Type	DPT	Flag
 16, 17	Channel 1 value	B.Disabling function 1 / 2	2 byte	9.001	C, -, T, (R) 1

Description 2-byte object for the transmission of value telegrams, if 2-channel operation is activated.

1: For reading, the R-flag must be set. The last value written to the object via the bus will be read.

Function: 2-channel operation

Object	Function	Name	Type	DPT	Flag
 34, 35	Channel 2 switching	B.Disabling function 1 / 2	1-bit	1.xxx	C, W, T, (R) ¹

Description 1-bit object for the transmission of switching telegrams, if 2-channel operation is activated.

Function: 2-channel operation

Object	Function	Name	Type	DPT	Flag
 34, 35	Channel 2 value	B.Disabling function 1 / 2	1 byte	5.xxx	C, -, T, (R) 1

Description 1-byte object for the transmission of value telegrams, if 2-channel operation is activated.

Function: 2-channel operation

Object	Function	Name	Type	DPT	Flag
 34, 35	Channel 2 value	B.Disabling function 1 / 2	2 byte	9.001	C, -, T, (R) 1

Description 2-byte object for the transmission of value telegrams, if 2-channel operation is activated.

Function: Disabling function

Object	Function	Name	Type	DPT	Flag
 54	Disabling	B.Disabling function 1 / 2	1-bit	1.001	C, W, -, (R) 1

Description 1-bit object by means of which the push button sensor can be disabled and enabled again (polarity configurable).

Object for operation LED

Function: Operation LED

Object	Function	Name	Type	DPT	Flag
 52	Switching	B.Operation LED	1-bit	1.001	C, W, -, (R) 1

Description 1-bit object to switch on or switch off the operation LED (polarity configurable).

1: For reading, the R-flag must be set. The last value written to the object via the bus will be read.

Objects for alarm message

Function: Alarm signal

Object	Function	Name	Type	DPT	Flag
 ⁵⁶	Switching	B.Alarm message	1-bit	1.xxx	C, W, -, (R) 1

Description 1-bit object for the reception of an alarm signalling (polarity configurable).

Function: Alarm signal

Object	Function	Name	Type	DPT	Flag
 ⁵⁷	Switching	B.Alarm message acknowledge	1-bit	1.xxx	C, -, T, (R) 1

Description 1-bit object for transmitting the acknowledgement of an alarm signalling (polarity configurable).

Objects for the controller extension

Function: Controller extension

Object	Function	Name	Type	DPT	Flag
 ⁵⁸	Operating mode switch-over	B.Controller- extension	1 byte	20.102	C, W, T, (R) ¹

Description 1-byte object for changing over a room temperature controller between the Comfort, Standby, Night and Frost/heat protection operating modes.

Function: Controller extension

Object	Function	Name	Type	DPT	Flag
 ⁵⁹	Forced operating mode switch-over	B.Controller- extension	1 byte	20.102	C, W, T, (R) ¹

Description 1-byte object for changing over a room temperature controller under forced control between the Automatic, Comfort, Standby, Night and Frost / heat protection operating modes.

Function: Controller extension

Object	Function	Name	Type	DPT	Flag
 ⁶⁰	Presence button	B.Controller- extension	1-bit	1.001	C, W, T, (R) ¹

Description 1-bit object for switching over the presence status of a room temperature controller (polarity configurable)

1: For reading, the R-flag must be set. The last value written to the object via the bus will be read.

Function: Controller extension

Object	Function	Name	Type	DPT	Flag
 ⁶¹	Setpoint shift specification	B.Controller-extension	1 byte	6.010	C, -, T, (R) ₁

Description 1-byte object for presetting a basic setpoint shift for a controller.
 $x \leq 0 \leq y$ (0 = no shift active); integral numbers
 Value object 62 + 1 (increase level value)
 Value object 62 - 1 (decrease level value)
 The possible range of values (x to y) is fixed by the setpoint adjusting range to the 'upper limit' or to the 'lower limit' (configurable) in combination with the level value on the room temperature controller.

Function: Controller extension

Object	Function	Name	Type	DPT	Flag
 ⁶²	Current setpoint shift	B.Controller-extension	1 byte	6.010	C, W, -, (R) ₁

Description 1-byte object used by the extension unit for receiving the current setpoint shift of the room temperature controller.
 $x \leq 0 \leq y$ (0 = no shift active); integral numbers
 The possible range of values (x to y) is fixed by the setpoint adjusting range to the 'upper limit' or to the 'lower limit' (configurable) in combination with the level value on the room temperature controller.

Function: Controller extension

Object	Function	Name	Type	DPT	Flag
 ⁶³	Controller status	B.Controller-extension	1 byte	--- ²	C, W, -, (R) ₁

Description 1-byte object used by the extension unit for receiving the current state of operation of the controller. Status LEDs that can be used to indicate a status independently of a button function can display one of the various information units which are grouped in this byte (bit-oriented evaluation).

Objects for light scene function

Function: Scene function

Object	Function	Name	Type	DPT	Flag
 ^{66...73}	Switching	B.Scenes-output 1 ³	1-bit	1.001	C, W, T, (R) ₁

Description 1-bit objects for controlling up to eight actuator groups (ON, OFF).

1: For reading, the R-flag must be set. The last value written to the object via the bus will be read.

2: Non-standardised DP type (in accordance with KNX AN 097/07 rev 3).

3: Scene outputs 2 ... 8 see scene output 1, shift of the object number (66 + number of scene output - 1).

Function: Scene function

Object	Function	Name	Type	DPT	Flag
 ^{66...73}	Value	B.Scenes-output 1 ¹	1 byte	5.001	C, W, T, (R) ²

Description 1-byte objects for controlling up to eight actuator groups (0...255).

Function: Scene function

Object	Function	Name	Type	DPT	Flag
 ⁷⁴	Extension unit input	B.Scenes	1 byte	18.001	C, W, -, (R) ₂

Description 1-byte object with which one of the eight internally stored scenes can be recalled or stored again.

1: Scene outputs 2 ... 8 see scene output 1, shift of the object number (66 + number of scene output - 1).

2: For reading, the R-flag must be set. The last value written to the object via the bus will be read.

4.2.3.2 Object table, controller function section

Objects for room temperature measurement (Part 1)

Function: Room temperature measurement

Object	Function	Name	Type	DPT	Flag
 ⁶⁴	Actual temperature	C.Output	2 byte	9.001	C, W, T, R

Description 2-byte object for the display of the actual temperature (room temperature), which is determined by the controller or controller extension. Possible value range: -99.9 °C to +99.9 °C / Measurement range of internal temperature sensor: 0 °C to +40 °C +/-1 %.

Function: Room temperature measurement

Object	Function	Name	Type	DPT	Flag
 ⁶⁵	External temperature sensor	C.Input	2 byte	9.001	C, W, -, (R) 1

Description 2-byte object for coupling an external room temperature sensor or a controller extension. Thus cascading of multiple temperature sensors for room temperature measurement. Possible range of values: -99.9 °C to +99.9 °C. This object is only available in this way when the temperature/remote sensor connected to the device does not have an effect on the room temperature measurement (parameter-dependent).

Function: Room temperature measurement / temperature detection of wired temperature/ remote sensor

Object	Function	Name	Type	DPT	Flag
 ⁶⁵	Temperature/remote sensor	C.Output	2 byte	9.001	C, -, -, R

Description 2-byte object to follow up the temperature value detected by the wired temperature/remote sensor for room temperature measurement. This object can be read out as necessary. It may not be written ("Write" flag not set). This object is only available in this way when the temperature/remote sensor connected to the device has an effect on the room temperature measurement (parameter-dependent).

1: For reading, the R-flag must be set. The last value written to the object via the bus will be read.

Object for setpoint temperature specification

Function: Setpoint temperature specification

Object	Function	Name	Type	DPT	Flag
 ⁸⁰	Basic setpoint	C.Input	2 byte	9.001	C, W, -, (R) ₁

Description 2-byte object for external setting of basic setpoint. Depending on the operating mode, the possible range of values is limited by the configured frost protection and/or heat protection temperature. The temperature values received are automatically rounded off and adjusted to the level value of the basic setpoint shift (0.5 K).

Objects for operating mode change-over

Function: Operating mode switchover

Object	Function	Name	Type	DPT	Flag
 ⁸²	Operating mode switchover	C.Input	1 byte	20.102	C, W, T, (R) ₁

Description 1-byte object for change-over of the operating mode of the controller according to the KNX specification. This object is only available in this way when the operating mode change-over is to take place over 1 byte (parameter-dependent).

Function: Operating mode switchover

Object	Function	Name	Type	DPT	Flag
 ⁸²	Comfort mode	C.Input	1-bit	1.001	C, W, T, (R) ₁

Description 1-bit object for change-over to the "Comfort" operating mode. This object is only available in this way when the operating mode change-over is to take place over 4 x 1 bit (parameter-dependent).

Function: Operating mode switchover

Object	Function	Name	Type	DPT	Flag
 ⁸³	Standby mode	C.Input	1-bit	1.001	C, W, T, (R) ₁

Description 1-bit object for change-over to the "Standby" operating mode. This object is only available in this way when the operating mode change-over is to take place over 4 x 1 bit (parameter-dependent).

1: For reading, the R-flag must be set. The last value written to the object via the bus will be read.

Function: Operating mode switchover

Object	Function	Name	Type	DPT	Flag
 84	Night operation	C.Input	1-bit	1.001	C, W, T, (R) ¹

Description 1-bit object for change-over to the "Night" operating mode. This object is only available in this way when the operating mode change-over is to take place over 4 x 1 bit (parameter-dependent).

Function: Operating mode switchover

Object	Function	Name	Type	DPT	Flag
 85	Frost/heat protection	C.Input	1-bit	1.001	C, W, T, (R) ¹

Description 1-bit object for change-over to the "Frost / heat protection" operating mode. This object is only available in this way when the operating mode change-over is to take place over 4 x 1 bit (parameter-dependent).

Function: Operating mode switchover

Object	Function	Name	Type	DPT	Flag
 86	Operating mode forced-control	C.Input	1 byte	20.102	C, W, T, (R) ¹

Description 1-byte object for forced change-over (highest priority) of the operating mode of the controller according to the KNX specification. This object is only available in this way when the operating mode change-over is to take place over 1 byte (parameter-dependent).

Function: Operating mode change-over presence detection

Object	Function	Name	Type	DPT	Flag
 87	Presence object	C.Input / Output	1-bit	1.001	C, W, T, (R) ¹

Description 1-bit object (bidirectional) which transmits the status of the presence button (if a presence button can be configured) on the bus or which a motion detector can be linked to the controller. Polarity: presence detected = "1", presence not detected = "0".

Function: Operating mode change-over window status

Object	Function	Name	Type	DPT	Flag
 88	Window status	C.Input	1-bit	1.019	C, W, -, (R) 1

Description 1-bit object for the coupling of window contacts. Polarity: Window open = "1", window closed = "0".

1: For reading, the R-flag must be set. The last value written to the object via the bus will be read.

Object for operating mode change-over

Function: Operating mode change-over

Object	Function	Name	Type	DPT	Flag
 ⁸⁹	Heating / cooling change-over	C.Output	1-bit	1.100	C, -, T, (R) ₁

Description: 1 bit object to transmit the automatically set operating mode of the controller ("Heating" or "Cooling" modes). Object value "1" = Heating; Object value "0" = Cooling. This object is only available in this way when the operating mode change-over is to take place automatically (parameter-dependent).

Function: Operating mode change-over

Object	Function	Name	Type	DPT	Flag
 ⁸⁹	Heating / cooling change-over	C.Input / Output	1-bit	1.100	C, W, T, (R) ₁

Description: 1 bit object to change-over the operating mode of the controller ("Heating" or "Cooling" modes). Object value "1" = Heating; Object value "0" = Cooling. This object is only available in this way when the operating mode change-over is to take place manually (not automatically by the controller) (parameter-dependent).

Object for controller status (Part 1)

Function: Controller status

Object	Function	Name	Type	DPT	Flag
 ⁹⁰	Controller status	C.Output	1-bit	1.001	C, -, T, (R) ₁

Description: 1-bit object for single status feedback of configured controller functions. This object is only available in this way when a part of the controller status is to be transmitted singly as 1-bit information (parameter-dependent).

Function: Controller status

Object	Function	Name	Type	DPT	Flag
 ⁹⁰	Controller status	C.Output	1 byte	--- ²	C, -, T, (R) ₁

Description: 1-byte object for collective status feedback of the controller. This object is only available in this way when the controller status is to be transmitted singly as 1-byte information (parameter-dependent).

1: For reading, the R-flag must be set. The last value written to the object via the bus will be read.

2: Non-standardised DP type (in accordance with KNX AN 097/07 rev 3).

Objects for heating / cooling signal functions

Function: Heating energy message

Object	Function	Name	Type	DPT	Flag
 ⁹¹	Heating message	C.Output	1-bit	1.001	C, -, T, (R) 1

Description 1-bit object for the controller to report a request for heating energy. Object value = "1": energy request, object value = "0": no energy request.

Function: Cooling energy message

Object	Function	Name	Type	DPT	Flag
 ⁹²	Cooling message	C.Output	1-bit	1.001	C, -, T, (R) 1

Description 1-bit object for the controller to report a request for cooling energy. Object value = "1": energy request, object value = "0": no energy request.

Objects for controller disabling functions

Function: Disable controller

Object	Function	Name	Type	DPT	Flag
 ⁹⁴	Disable controller	C.Input	1-bit	1.001	C, W, -, (R) 1

Description 1-bit object for deactivating the controller (activating dew point operation). Polarity: Controller deactivated = "1", controller activated = "0".

Function: Disable controller

Object	Function	Name	Type	DPT	Flag
 ⁹⁵	Disable additional level	C.Input	1-bit	1.001	C, W, -, (R) 1

Description 1-bit object for deactivating the additional level of the controller. Polarity: Additional level deactivated = "1", additional level activated = "0". This object is only available in this way if two-level heating or cooling operation is configured.

1: For reading, the R-flag must be set. The last value written to the object via the bus will be read.

Object for heating command value output and combined valve heating/cooling

Function: Command value

Object	Function	Name	Type	DPT	Flag
 ⁹⁶	Command value for heating / command value, basic heating	C.Output	1 byte	5.001	C, -, T, (R) 1

Description 1-byte object to output the continuous command value of the heating mode. In two-level heating mode, command value output for the basic heating. This object is only available in this way if the type of feedback control is configured to "Continuous PI control".

Function: Command value

Object	Function	Name	Type	DPT	Flag
 ⁹⁶	Command value for heating (PWM) / command value, basic heating (PWM)	C.Output	1-bit	1.001	C, -, T, (R) 1

Description 1-bit object to output the PWM command value of the heating mode. In two-level heating mode, command value output for the basic heating. This object is only available in this way if the type of feedback control is configured to "Switching PI control (PWM)".

Function: Command value

Object	Function	Name	Type	DPT	Flag
 ⁹⁶	Command value for heating / command value, basic heating	C.Output	1-bit	1.001	C, -, T, (R) 1

Description 1-bit object to output the switching command value of the heating mode. In two-level heating mode, command value output for the basic heating. This object is only available in this way if the type of feedback control is configured to "Switching 2-point feedback control".

Function: Command value

Object	Function	Name	Type	DPT	Flag
 ⁹⁶	Command value for heating/cooling / command value, basic level	C.Output	1 byte	5.001	C, -, T, (R) 1

Description 1-byte object to output the combined continuous command value of the heating and cooling mode. In two-level heating/cooling mode, command value output for the basic level. This object is only available in this way if the command values for heating and cooling mode are output to a shared object (parameter-dependent). The type of feedback control must also be configured to "Continuous PI control".

1: For reading, the R-flag must be set. The last value written to the object via the bus will be read.

Function: Command value

Object	Function	Name	Type	DPT	Flag
 ⁹⁶	Command value for heating/cooling (PWM) / command value, basic level (PWM)	C.Output	1-bit	1.001	C, -, T, (R) ₁

Description 1-bit object to output the combined PWM command value of the heating and cooling mode. In two-level heating/cooling mode, command value output for the basic level This object is only available in this way if the command values for heating and cooling mode are output to a shared object (parameter-dependent). The type of feedback control must also be configured to "Switching PI control (PWM)".

Function: Command value

Object	Function	Name	Type	DPT	Flag
 ⁹⁶	Command value for heating/cooling / command value, basic level	C.Output	1-bit	1.001	C, -, T, (R) ₁

Description 1-bit object to output the combined switching command value of the heating and cooling mode. In two-level heating/cooling mode, command value output for the basic level This object is only available in this way if the command values for heating and cooling mode are output to a shared object (parameter-dependent). The type of feedback control must also be configured to "Switching 2-point feedback control".

Object for command value output, additional heating and combined valve additional heating/cooling

Function: Command value

Object	Function	Name	Type	DPT	Flag
 ⁹⁷	Command value, additional heating	C.Output	1 byte	5.001	C, -, T, (R) ₁

Description 1-byte object to output the continuous command value for additional heating in two-level operation. This object is only available in this way if the type of feedback control is configured to "Continuous PI control".

Function: Command value

Object	Function	Name	Type	DPT	Flag
 ⁹⁷	Command value, additional heating (PWM)	C.Output	1-bit	1.001	C, -, T, (R) ₁

Description 1-bit object to output the continuous PWM command value for additional heating in two-level operation. This object is only available in this way if the type of feedback control is configured to "Switching PI control (PWM)".

1: For reading, the R-flag must be set. The last value written to the object via the bus will be read.

Function: Command value

Object	Function	Name	Type	DPT	Flag
 ⁹⁷	Command value, additional heating	C.Output	1-bit	1.001	C, -, T, (R) ₁

Description 1-byte object to output the switching command value for additional heating in two-level operation. This object is only available in this way if the type of feedback control is configured to "Switching 2-point feedback control".

Function: Command value

Object	Function	Name	Type	DPT	Flag
 ⁹⁷	Command value, additional level	C.Output	1 byte	5.001	C, -, T, (R) ₁

Description 1-byte object to output the combined continuous command value for additional level in two-level operation. This object is only available in this way if the command values for heating and cooling mode are output to a shared object (parameter-dependent). The type of feedback control must also be configured to "Continuous PI control".

Function: Command value

Object	Function	Name	Type	DPT	Flag
 ⁹⁷	Command value, additional level (PWM)	C.Output	1-bit	1.001	C, -, T, (R) ₁

Description 1-bit object to output the combined switching PWM command value for additional level in two-level operation. This object is only available in this way if the command values for heating and cooling mode are output to a shared object (parameter-dependent). The type of feedback control must also be configured to "Switching PI control (PWM)".

Function: Command value

Object	Function	Name	Type	DPT	Flag
 ⁹⁷	Command value, additional level	C.Output	1-bit	1.001	C, -, T, (R) ₁

Description 1-bit object to output the combined switching command value for additional level in two-level operation. This object is only available in this way if the command values for heating and cooling mode are output to a shared object (parameter-dependent). The type of feedback control must also be configured to "Switching 2-point feedback control".

1: For reading, the R-flag must be set. The last value written to the object via the bus will be read.

Object for command value output, cooling

Function: Command value

Object	Function	Name	Type	DPT	Flag
 ⁹⁸	Command value for cooling / command value, basic cooling	C.Output	1 byte	5.001	C, -, T, (R) 1

Description: 1-byte object to output the continuous command value of the cooling mode. In two-level cooling mode, command value output for the basic cooling. This object is only available in this way if the type of feedback control is configured to "Continuous PI control".

Function: Command value

Object	Function	Name	Type	DPT	Flag
 ⁹⁸	Command value for cooling (PWM) / command value, basic cooling (PWM)	C.Output	1-bit	1.001	C, -, T, (R) 1

Description: 1-bit object to output the PWM command value of the cooling mode. In two-level cooling mode, command value output for the basic cooling. This object is only available in this way if the type of feedback control is configured to "Switching PI control (PWM)".

Function: Command value

Object	Function	Name	Type	DPT	Flag
 ⁹⁸	Command value for cooling / command value, basic cooling	C.Output	1-bit	1.001	C, -, T, (R) 1

Description: 1-bit object to output the switching command value of the cooling mode. In two-level cooling mode, command value output for the basic cooling. This object is only available in this way if the type of feedback control is configured to "Switching 2-point feedback control".

Object for command value output, additional cooling

Function: Command value

Object	Function	Name	Type	DPT	Flag
 ⁹⁹	Command value, additional cooling	C.Output	1 byte	5.001	C, -, T, (R) 1

Description: 1-byte object to output the continuous command value for additional cooling in two-level operation. This object is only available in this way if the type of feedback control is configured to "Continuous PI control".

1: For reading, the R-flag must be set. The last value written to the object via the bus will be read.

Function:	Command value				
Object	Function	Name	Type	DPT	Flag
 ⁹⁹	Command value, additional cooling (PWM)	C.Output	1-bit	1.001	C, -, T, (R) ₁
Description	1-bit object to output the continuous PWM command value for additional cooling in two-level operation. This object is only available in this way if the type of feedback control is configured to "Switching PI control (PWM)".				

Function:	Command value				
Object	Function	Name	Type	DPT	Flag
 ⁹⁹	Command value, additional cooling	C.Output	1-bit	1.001	C, -, T, (R) ₁
Description	1-byte object to output the switching command value for additional cooling in two-level operation. This object is only available in this way if the type of feedback control is configured to "Switching 2-point feedback control".				

Object for additional PWM heating command value output and combined valve PWM additional heating/cooling

Function:	Command value				
Object	Function	Name	Type	DPT	Flag
 ¹⁰⁰	PWM command value for heating / PWM command value, basic heating	C.Output	1 byte	5.001	C, -, T, (R) ₁
Description	1-byte object to output the internal continuous command value of a PWM controller of the heating mode. In two-level heating mode, command value output for the basic heating. This object is only available in this way if the type of feedback control is configured to "Switching PI control (PWM)". In addition to the switching 1 bit command value of the PWM, the calculated continuous command value of the controller can also be transmitted to the bus and displayed, e.g. in a visualisation.				

1: For reading, the R-flag must be set. The last value written to the object via the bus will be read.

Function: Command value

Object	Function	Name	Type	DPT	Flag
 ¹⁰⁰	PWM command value for heating/cooling / PWM command value, basic level	C.Output	1 byte	5.001	C, -, T, (R) ₁

Description 1-byte object to output the combined continuous command value of a PWM controller of the heating and cooling mode. In two-level heating/cooling mode, command value output for the basic level This object is only available in this way if the command values for heating and cooling mode are output to a shared object (parameter-dependent). The type of feedback control must also be configured to "Switching PI control (PWM)". In addition to the switching 1 bit command value of the PWM, the calculated continuous command value of the controller can also be transmitted to the bus and displayed, e.g. in a visualisation.

Object for additional command value output, PWM additional heating and combined valve PWM additional heating/cooling

Function: Command value

Object	Function	Name	Type	DPT	Flag
 ¹⁰¹	PWM command value, additional heating	C.Output	1 byte	5.001	C, -, T, (R) ₁

Description 1-byte object to output the internal continuous command value of a PWM controller for additional heating in two-level operation. This object is only available in this way if the type of feedback control is configured to "Continuous PI control". In addition to the switching 1 bit command value of the PWM, the calculated continuous command value of the controller can also be transmitted to the bus and displayed, e.g. in a visualisation.

Function: Command value

Object	Function	Name	Type	DPT	Flag
 ¹⁰¹	PWM command value, additional level	C.Output	1 byte	5.001	C, -, T, (R) ₁

Description 1-byte object to output the combined continuous command value of a PWM feedback controller for additional level in two-level operation. This object is only available in this way if the command values for heating and cooling mode are output to a shared object (parameter-dependent). The type of feedback control must also be configured to "Switching PI control (PWM)". In addition to the switching 1 bit command value of the PWM, the calculated continuous command value of the controller can also be transmitted to the bus and displayed, e.g. in a visualisation.

1: For reading, the R-flag must be set. The last value written to the object via the bus will be read.

Object for additional command value output, PWM cooling

Function: Command value

Object	Function	Name	Type	DPT	Flag
 ¹⁰²	PWM command value for cooling / PWM command value, basic cooling	C.Output	1 byte	5.001	C, -, T, (R) 1

Description 1-byte object to output the internal continuous command value of a PWM feedback controller of the cooling mode. In two-level cooling mode, command value output for the basic cooling. This object is only available in this way if the type of feedback control is configured to "Switching PI control (PWM)". In addition to the switching 1 bit command value of the PWM, the calculated continuous command value of the controller can also be transmitted to the bus and displayed, e.g. in a visualisation.

Object for additional command value output, PWM additional cooling

Function: Command value

Object	Function	Name	Type	DPT	Flag
 ¹⁰³	PWM command value, additional cooling	C.Output	1 byte	5.001	C, -, T, (R) 1

Description 1-byte object to output the internal continuous command value of a PWM feedback controller for additional cooling in two-level operation. This object is only available in this way if the type of feedback control is configured to "Switching PI control (PWM)". In addition to the switching 1 bit command value of the PWM, the calculated continuous command value of the controller can also be transmitted to the bus and displayed, e.g. in a visualisation.

Object for outputting the setpoint temperature

Function: Setpoint temperature

Object	Function	Name	Type	DPT	Flag
 ¹⁰⁴	Setpoint temperature	C.Output	2 byte	9.001	C, -, T, R

Description 2-byte object for the output of the current temperature setpoint. Depending on the operating mode, the possible range of values is limited by the configured frost protection and/or heat protection temperature.

1: For reading, the R-flag must be set. The last value written to the object via the bus will be read.

Object for basic setpoint shift

Function: Basic setpoint shift

Object	Function	Name	Type	DPT	Flag
 ¹⁰⁶	Current setpoint shift	C.Output	1 byte	6.010	C, -, T, R

Description 1-byte object for giving feedback on the current basic setpoint shift.
 $x \leq 0 \leq y$ (0 = no shift active); integral numbers.
The possible range of values (x to y) is fixed within the preset limits of the setpoint (configurable) in connection with the level value (0.5 °C)

Function: Basic setpoint shift

Object	Function	Name	Type	DPT	Flag
 ¹⁰⁷	Setpoint shift specification	C.Input	1 byte	6.010	C, W, -, (R) 1

Description 1-byte object to specify a basic setpoint shift, e.g. using a controller extension.
 $x \leq 0 \leq y$ (0 = no shift active); integral numbers.
The possible range of values (x to y) is fixed within the preset limits of the setpoint (configurable) in connection with the level value (0.5 °C) In case the limits of the value range are exceeded by the preset external value, the controller will automatically reset the received value to the minimum and maximum limits.

Object for controller status (Part 2)

Function: Controller status

Object	Function	Name	Type	DPT	Flag
 ¹⁰⁸	Status signal addition	C.Output	1 byte	--- ²	C, -, T, (R) 1

Description 1-byte object for extended collective status feedback of the controller. For connecting controller extensions.

Object for room temperature measurement (Part 2)

Function: Room temperature measurement

Object	Function	Name	Type	DPT	Flag
 ¹⁰⁹	Actual temp. not adjusted	C.Output	2 byte	9.001	C, -, T, R

Description 2-byte object for following-up the determined and unadjusted room temperature value.

1: For reading, the R-flag must be set. The last value written to the object via the bus will be read.

2: Non-standardised DP type.

Objects for fan control (Part 1)

Function: Fan controller

Object	Function	Name	Type	DPT	Flag
 ¹¹⁰	Ventilation, automatic/manual	C.Input	1-bit	1.001	C, W, T, (R) ¹

Description 1-bit object to change-over the operating mode of the fan controller (configurable polarity). When the operating mode is changed over using a push-button function, a telegram matching the current status is transmitted to the bus.

Function: Fan controller

Object	Function	Name	Type	DPT	Flag
 ¹¹¹	Ventilation, fan level 1-3	C.Output	1-bit	5.010	C, -, T, R

Description 1-byte object for value-guided activation of the fan levels. This object is only available in this way when the fan control is to take place over 1 byte (parameter-dependent).

Function: Fan controller

Object	Function	Name	Type	DPT	Flag
 ¹¹¹	Ventilation, fan level 1	C.Output	1-bit	1.001	C, -, T, R

Description 1-bit object for switching activation of the first fan level. This object is only available in this way when the fan control is to take place over 3 x 1 bit and at least one fan level is enabled (parameter-dependent).

Function: Fan controller

Object	Function	Name	Type	DPT	Flag
 ¹¹²	Ventilation, fan level 2	C.Output	1-bit	1.001	C, -, T, R

Description 1-bit object for switching activation of the second fan level. This object is only available when the fan control is to take place over 3 x 1 bit and at least two fan levels are enabled (parameter-dependent).

Function: Fan controller

Object	Function	Name	Type	DPT	Flag
 ¹¹³	Ventilation, fan level 3	C.Output	1-bit	1.001	C, -, T, R

Description 1-bit object for switching activation of the third fan level. This object is only available when the fan control is to take place over 3 x 1 bit and at least three fan levels are enabled (parameter-dependent).

1: For reading, the R-flag must be set. The last value written to the object via the bus will be read.

Function: Fan controller

Object	Function	Name	Type	DPT	Flag
 ¹¹⁹	Ventilation, forced position	C.Input	1-bit	1.001	C, W, -, (R) 1

Description 1-bit object for activation of the fan forced position. Polarity:
Forced position ON = "1"; Forced position OFF = "0".

Function: Fan controller

Object	Function	Name	Type	DPT	Flag
 ¹²⁰	Ventilation, level limit	C.Input	1-bit	1.001	C, W, -, (R) 1

Description 1-bit object for activation of the fan level limitation. Polarity:
Fan level limitation ON = "1"; Fan level limitation OFF = "0".

Function: Fan controller

Object	Function	Name	Type	DPT	Flag
 ¹²¹	Ventilation, fan protection	C.Input	1-bit	1.001	C, W, -, (R) 1

Description 1-bit object for activating the fan protection. Polarity:
Fan protection ON = "1" / Fan protection OFF = "0".

Object for detecting the outdoor temperature

Function: Outdoor temperature

Object	Function	Name	Type	DPT	Flag
 ¹²²	Outdoor temperature	C.Input	2 byte	9.001	C, W, T, (R) ¹

Description 2-byte object for detecting the outdoor temperature The received value is used
solely for the display. Possible range of values: -99.9 °C to +99.9 °C.

Object for limiting the setpoint temperature

Function: Setpoint temperature limit

Object	Function	Name	Type	DPT	Flag
 ¹²³	Limit of cooling setpoint temperature	C.Input	1-bit	1.001	C, W, -, (R) 1

Description 1-bit object for activating the setpoint temperature limit. Polarity:
Setpoint temperature limit ON = "1"; Setpoint temperature limit OFF = "0".

1: For reading, the R-flag must be set. The last value written to the object via the bus will be read.

Object for limiting the floor temperature

Function: Floor temperature limitation

Object	Function	Name	Type	DPT	Flag
 124	Floor temperature	C.Input	2 byte	9.001	C, W, -, (R) 1

Description 2-byte object for coupling an external temperature sensor for floor temperature limitation. This object is only available in this way when the temperature/remote sensor connected to the device does not have an effect on the floor temperature limitation (parameter-dependent).

Function: Floor temperature limitation / temperature detection of wired temperature/remote sensors

Object	Function	Name	Type	DPT	Flag
 124	Temperature/remote sensor	C.Output	2 byte	9.001	C, -, -, R

Description 2-byte object to follow up the temperature value detected by the wired temperature/remote sensor for floor temperature limitation. This object can be read out as necessary. It may not be written ("Write" flag not set). This object is only available in this way when the temperature/remote sensor connected to the device has an effect on the floor temperature limitation (parameter-dependent).

Objects for fan control (Part 2)

Function: Fan controller

Object	Function	Name	Type	DPT	Flag
 129	Ventilation visualisation	C.Output	1 byte	5.010	C, -, T, R

Description 1-byte object for additional value-guided acknowledgement of the active fan level. Value meaning: "0" = Fan OFF, "1" = level 1 active, "2" = level 2 active, "3" = level 3 active.

1: For reading, the R-flag must be set. The last value written to the object via the bus will be read.

4.2.3.3 Display object table

Objects for display control

Function:	Time				
Object	Function	Name	Type	DPT	Flag
 ¹³⁰	Time	D.Input	3 byte	10.001	C, W, T, (R) ¹
Description	3-byte object for receiving the current time via the bus. The time can be shown on the display (parameter-dependent).				

Function:	Backlighting				
Object	Function	Name	Type	DPT	Flag
 ¹³³	Backlighting On/Off	D.Input	1-bit	1.001	C, W, -, (R) ₁
Description	1-bit object to switch the backlighting of the LED display (polarity configurable).				

Function:	Recall display information				
Object	Function	Name	Type	DPT	Flag
 ¹³⁵	Recall display information	D.Input	1-bit	1.001	C, W, -, (R) ₁
Description	1-bit object for targeted recall of display information (parameter-dependent). This object is only available in this why when the display information is to be recalled via a switching object.				

Function:	Recall display information				
Object	Function	Name	Type	DPT	Flag
 ¹³⁵	Recall display information	D.Input	1 byte	5.010	C, W, -, (R) ₁
Description	1-byte object for value-guided recall of display information. This object is only available in this why when the display information is to be recalled via a value object.				

1: For reading, the R-flag must be set. The last value written to the object via the bus will be read.

Additional objects for display control with a controller extension

Function: Command value

Object	Function	Name	Type	DPT	Flag
 ¹⁰⁰	Command value for heating	D.Input Controller ext.	1 byte	5.001	C, W, -, (R) 1

Description: 1-byte object to evaluate the continuous command value of the heating mode on the controller extension. This object is only available in this way if the adaptation of the type of feedback control is configured to "Continuous PI feedback control" in the controller extension. This object should be connected to the main controller object with the same function.

Function: Command value

Object	Function	Name	Type	DPT	Flag
 ¹⁰⁰	Cmd. value heating/cooling	D.Input Controller ext.	1 byte	5.001	C, W, -, (R) 1

Description: 1-byte object to evaluate the combined continuous command value of the heating and cooling mode on the controller extension. This object is only available in this way if the controller outputs the command values for heating and cooling mode to a shared object and the mode adaptation of feedback control is configured to "Continuous PI feedback control" in the controller extension. This object should be connected to the main controller object with the same function.

Function: Command value

Object	Function	Name	Type	DPT	Flag
 ¹⁰⁰	Command value for heating (PWM)	D.Input Controller ext.	1-bit	1.001	C, W, -, (R) 1

Description: 1-bit object to evaluate the switching PWM command value of the heating mode on the controller extension. This object is only available in this way if the adaptation of control is configured to "Switching PI control (PWM)" in the controller extension. This object should be connected to the main controller object with the same function.

Function: Command value

Object	Function	Name	Type	DPT	Flag
 ¹⁰⁰	Cmd. value heat./cool. (PWM)	D.Input Controller ext.	1-bit	1.001	C, W, -, (R) 1

Description: 1-bit object to evaluate the combined switching PWM command value of the heating and cooling mode on the controller extension. This object is only available in this way if the controller outputs the command values for heating and cooling mode to a shared object and the mode adaptation of control is configured to "Switching PI control (PWM)" in the controller extension. This object should be connected to the main controller object with the same function.

1: For reading, the R-flag must be set. The last value written to the object via the bus will be read.

Function: Command value

Object	Function	Name	Type	DPT	Flag
 ¹⁰⁰	Command value for heating	D.Input Controller ext.	1-bit	1.001	C, W, -, (R) 1

Description 1-byte object to evaluate the switching command value of the heating mode on the controller extension. This object is only available in this way if the adaptation of the type of feedback control is configured to "Switching 2-point feedback control" in the controller extension. This object should be connected to the main controller object with the same function.

Function: Command value

Object	Function	Name	Type	DPT	Flag
 ¹⁰⁰	Cmd. value heating/cooling	D.Input Controller ext.	1-bit	1.001	C, W, -, (R) 1

Description 1-bit object to evaluate the combined switching command value of the heating and cooling mode on the controller extension. This object is only available in this way if the controller outputs the command values for heating and cooling mode to a shared object and the adaptation of the type of feedback control is configured to "Switching 2-point feedback control" in the controller extension. This object should be connected to the main controller object with the same function.

Function: Command value

Object	Function	Name	Type	DPT	Flag
 ¹⁰²	Command value for cooling	D.Input Controller ext.	1 byte	5.001	C, W, -, (R) 1

Description 1-byte object to evaluate the continuous command value of the cooling mode on the controller extension. This object is only available in this way if the adaptation of the type of feedback control is configured to "Continuous PI feedback control" in the controller extension. This object should be connected to the main controller object with the same function.

Function: Command value

Object	Function	Name	Type	DPT	Flag
 ¹⁰²	Command value for cooling (PWM)	D.Input Controller ext.	1-bit	1.001	C, W, -, (R) 1

Description 1-bit object to evaluate the switching PWM command value of the cooling mode on the controller extension. This object is only available in this way if the adaptation of control is configured to "Switching PI control (PWM)" in the controller extension. This object should be connected to the main controller object with the same function.

1: For reading, the R-flag must be set. The last value written to the object via the bus will be read.

Function: Command value

Object	Function	Name	Type	DPT	Flag
 102	Command value for cooling	D.Input Controller ext.	1-bit	1.001	C, W, -, (R) ₁

Description 1-bit object to evaluate the switching command value of the cooling mode on the controller extension. This object is only available in this way if the adaptation of the type of feedback control is configured to "Switching 2-point feedback control" in the controller extension. This object should be connected to the main controller object with the same function.

Function: Display of setpoint temperature

Object	Function	Name	Type	DPT	Flag
 104	Setpoint temperature	D.Input Controller ext.	2 byte	9.001	C, W, -, - ¹

Description 2-byte object for the display of the current temperature setpoint. This object should be connected to the main controller object of the same name.

Function: Controller status indication

Object	Function	Name	Type	DPT	Flag
 108	Status signal addition	D.Input Controller ext.	1 byte	--- ²	C, W, T, (R) ₁

Description 1-byte object to display various controller states on the controller extension. This object should be connected to the main controller object of the same name.

Function: Fan display

Object	Function	Name	Type	DPT	Flag
 129	Ventilation visualisation	D.Input Controller ext.	1 byte	5.010	C, W, T, R

Description 1-byte object to display the active fan level on the controller extension. This object should be connected to the object of the same name in the main controller. Value meaning: "0" = Fan OFF, "1" = level 1 active, "2" = level 2 active, "3" = level 3 active.

1: For reading, the R-flag must be set. The last value written to the object via the bus will be read.

2: Non-standardised DP type.

4.2.4 Functional description

4.2.4.1 Push button sensor

4.2.4.1.1 Operation concept and button evaluation

Introduction

The device consists of several sensor areas, which can be operated by touching them with your finger. The number of sensor areas depends on the device variant used.

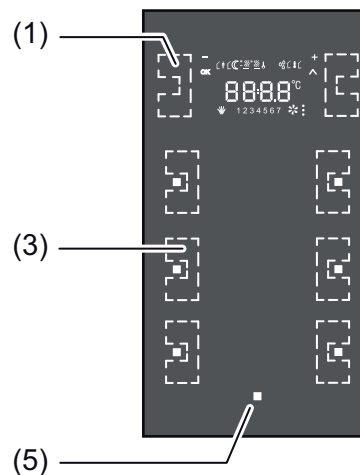

Figure 13: Button arrangement (using the example of the triple display variant)

With the sensor surfaces, a distinction is made between the display buttons (1) and the buttons of the push button sensor function (3). The display buttons are located immediately to the left and right of the display and operate predefined functions of the integrated room temperature controller or the controller extension. In addition, these buttons can also be used to activate the Cleaning function to clean the glass surface.

The buttons beneath are allocated to the push button sensor function. The number of these buttons depends on the device variant. The push button sensor function is an independent function section of the device with its own parameter blocks in the ETS.

In the ETS, the control concept of the buttons for the push button sensor function can either be configured as a rocker function or alternatively as a button function in the parameter node "Push button sensor -> Rocker/button selection". With the rocker function, two neighbouring sensor buttons (3) are assigned an identical function. For the button function, each sensor area is evaluated separately, meaning that different functions can be executed. When two sensors surfaces are combined into one rocker, it is also possible to trigger special functions by a press on the whole surface. Full-surface operation is simultaneous operation of both sensor areas (left / right) of the rocker.

Next to each sensor surface, there is a status LED, which can be connected to the control function, according to the function of the rocker or button. It may, however, also be used for signalling completely independent display information, flash or be permanently on or off. The operation LED (5) can also signal the switching state of its own object, flash or be permanently on or off. Besides functions that can be set using the ETS, the operation LED also indicates that the push button sensor is in the programming mode for commissioning or diagnosis purposes.

i Both display buttons have no status LEDs.

- i** Pressing several rockers or buttons at the same time will be considered as a wrong operation. Not included in this is the special rocker function "Full surface operation" or operation of the display buttons (basic setpoint shift and second operating level).

Button pair as rocker function

In the rocker operating concept, two adjacent sensor areas are used as a rocker. The two sensor areas are then termed the left and right rocker buttons. Pressing the buttons affect the communication objects assigned to the rocker. Usually, pressing both sides of a socket can directly opposite reactions (e.g. switching: left ON - right OFF / Venetian blind: left UP - right DOWN).

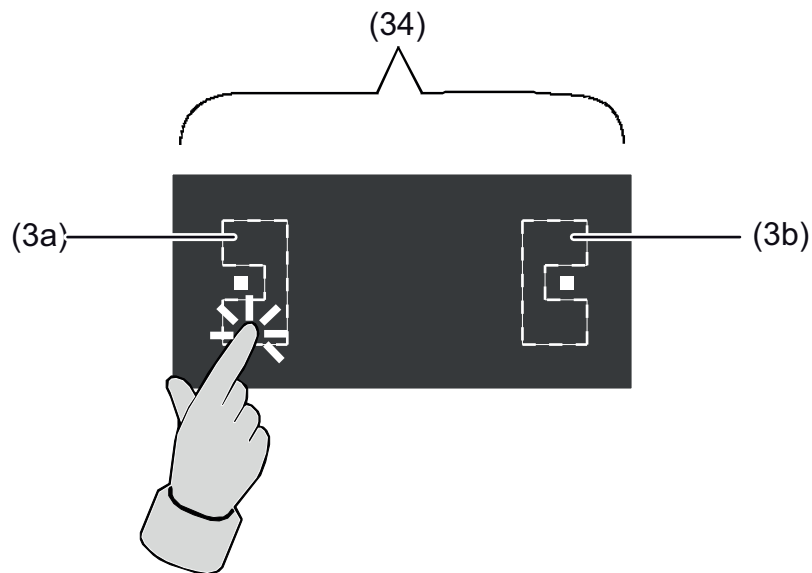

Figure 14: Rocker operation, left

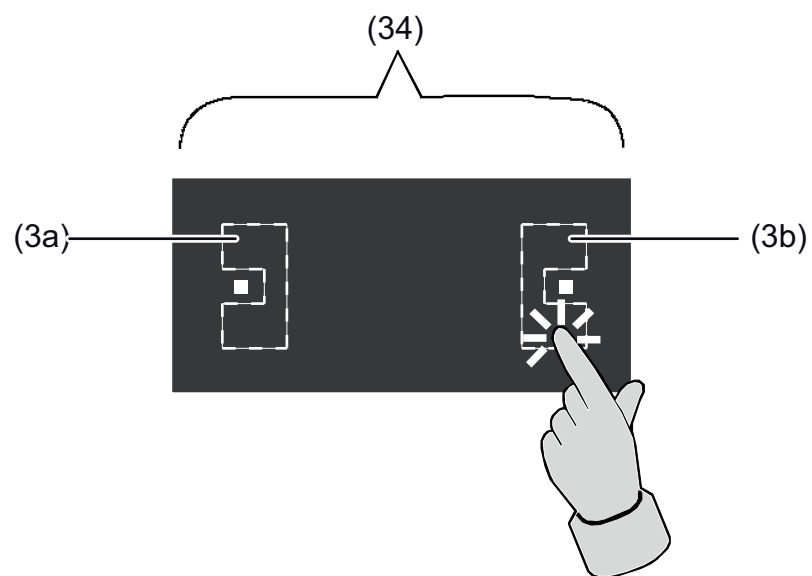

Figure 15: Rocker operation, right

(3a) Left button of the rocker

(3b) Right button of the rocker

(34) Rocker

Full-surface operation with rocker function

Depending on the function setting of a rocker, full-surface operation can also be optionally configured. This allows execution of additional functions, separate from the basic rocker function. Full-surface operation is simultaneous operation of both sensor areas (left / right) of a rocker.

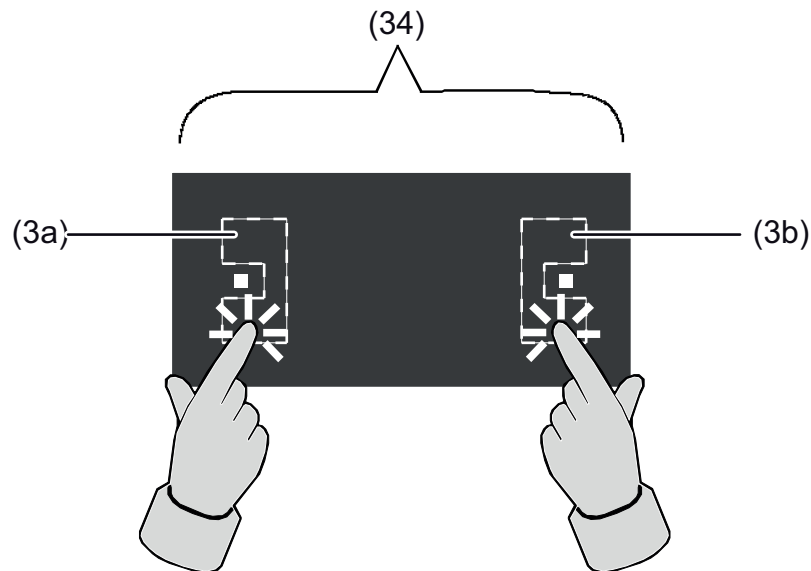

Figure 16: Full-surface rocker operation

(3a) Left button of the rocker

(3b) Right button of the rocker

(34) Rocker

i Full-surface operation can only be configured in the rocker function.

Button pair as push-button function

In the button operating concept, two adjacent sensor areas are divided up into two separate buttons. The buttons can be configured independently of one another and can fulfil completely different functions (e.g. switching: TOGGLE - Controller operating mode: Comfort).

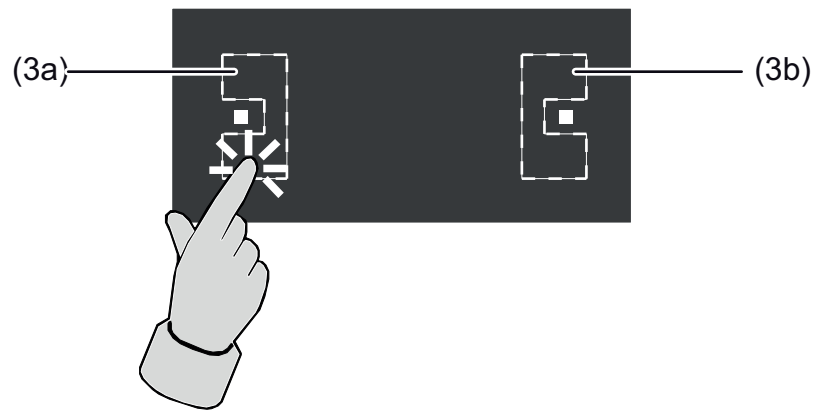

Figure 17: Button operation

- (3a) Left button (irrespective of the right button)
- (3b) Right button (irrespective of the left button)

4.2.4.1.2 Function of the display buttons

The display buttons are located to the left and right of the display and operate predefined functions of the integrated room temperature controller or the controller extension. In addition, these buttons can also be used to activate the Cleaning function to clean the glass surface.

The function of the display buttons depends on the configuration of the room temperature controller. A distinction is made between the settings of the "Room temperature controller function" parameter in the "Room temperature control" parameter node with regard to their effect on the scope of function of the display buttons as follows...

- "Enabled" setting:
The basic setpoint of the internal controller can be adjusted using the display buttons. In addition, the menu items of the second operation level, which affect the controller, can be opened and operated. In necessary, the cleaning function can also be activated. Access to the menu items in the second operating level using the display buttons is primarily dependent on the parameter settings of the second operating level and the controller mode.
 - "Controller extension" setting:
The basic setpoint of an external controller can be adjusted using the display buttons. In the display, the setpoint shift is displayed as a relative value. In addition, it is possible to switch to the second operating level, in order to activate the Cleaning function as necessary. In the function as a controller extension, adjustment of additional parameters in the second operating level is not possible using the display buttons.
 - "Switched off" setting:
It is only possible to switch to the second operating level using the display buttons, in order to activate the Cleaning function as necessary. Controller operation is not possible.
- i** The operation of the display buttons and the menu guidance in the second operating level is described in detail in the chapter "Operation" (see chapter 2.5. Operation). Additional information, in particular on the basic setpoint shift and setting the controller temperature values can be found in the chapters "Room temperature controller " and "Room temperature controller extension" .

4.2.4.1.3 Switching function

For each rocker or each button with the function set to "Switching", the ETS indicates a 1-bit communication object. The parameters of the rocker or button permit fixing the value this object is to adopt on pressing and / or on releasing (ON, OFF, TOGGLE – toggling of the object value). No distinction is made between a brief or long press.

The status LEDs can be configured independently (see chapter 4.2.4.1.13. Status LED).

4.2.4.1.4 Dimming function

For each rocker or each button with the function set to "Dimming", the ETS indicates a 1-bit object and a 4-bit object. Generally, the push button sensor transmits a switching telegram after a brief press and a dimming telegram after a long press. In the standard parameterisation, the push button sensor transmits a telegram for stopping the dimming action after a long press. The time needed by the pushbutton sensor to detect an actuation as a long actuation can be set in the parameters.

The status LEDs can be configured independently (see chapter 4.2.4.1.13. Status LED).

Single-surface and double-surface operation in the dimming function

As a rocker, the device is preprogrammed for double-surface actuation for the dimming function. This means that the pushbutton sensor transmits a telegram for switch-on after a brief press and a telegram for increasing the brightness after a long press of the left button ("brighter"). Similarly, the pushbutton sensor transmits a telegram for switch-off after a brief press and a telegram for reducing the brightness after a long press on the right button ("darker").

As a button, the device is preprogrammed for single-surface actuation for the dimming function. In this mode, the push button sensor transmits on each brief press ON and OFF telegrams in an alternating pattern ("TOGGLE"). After a long press, the push button sensor transmits "brighter" and "darker" telegrams in an alternating pattern.

The parameter "Command on pressing the button" or "Command on pressing the rocker" on the parameter pages of the buttons or rockers defines the single-surface or double-surface operation principle for the dimming function.

For the rocker and also for the button function, the command issued on pressing the button or rocker can basically be selected at the user's discretion.

Advanced parameters

For the dimming function, the pushbutton sensor can be programmed with advanced parameters which are hidden in the standard view for greater clarity. If necessary, these advanced parameters can be activated and thus be made visible.

The advanced parameters can be used to determine whether the pushbutton sensor is to cover the full adjusting range of the actuator with one dimming telegram continuously ("Increase brightness by 100 %", "Reduce brightness by 100 %") or whether the dimming range is to be divided into several small levels (50 %, 25 %, 12.5 %, 6 %, 3 %, 1.5 %).

In the continuous dimming mode (100%), the push button sensor transmits a telegram only at the beginning of the long press to start the dimming process and generally a stop telegram after the end of the press. For dimming in small levels it may be useful if the push button sensor repeats the dimming telegram in case of a sustained press for a presettable time (parameter "Telegram repetition"). The stop telegram after the end of the press is then not needed.

When the parameters are hidden ("Advanced parameters = deactivated"), the dimming range is set to 100 %, the stop telegram is activated and the telegram repetition is deactivated.

Full-surface operation

When a rocker is used for dimming, the push button sensor needs some time at the beginning of each operation in order to distinguish between a short and a long operation. When the full-surface operation is enabled in the ETS, the pushbutton sensor can make use of this time span to evaluate the otherwise invalid simultaneous actuation of both actuation points.

The pushbutton sensor detects a full-surface operation of a rocker if a control surface is depressed over a large area so that both buttons of the rocker are actuated.

When the pushbutton sensor has detected a valid full-surface actuation, the operation LED flashes quickly at a frequency of about 8 Hz for the duration of such actuation. Full-surface operation must have been detected before the first telegram has been transmitted by the dimming function (switching or dimming). If this is not so, even a full-surface operation will be interpreted as a wrong operation and not be executed.

Full-surface actuation is independent. It has a communication object of its own and can optionally be used for switching (ON, OFF, TOGGLE – toggling of the object value) or for scene recall without or with storage function. In the last case, a press on the full surface causes a scene to be recalled in less than a second. If the push button sensor is to send the telegram for storing a scene, full-surface actuation must be maintained for more than five seconds. If full-surface

actuation ends between the first and the fifth second, the push button sensor will not send any telegrams. If the status LEDs of the rocker are used as "button-press displays", they will light up for three seconds during transmission of the storage telegram.

i Full-surface actuation cannot be configured in the push button functions.

4.2.4.1.5 Venetian blind function

For each rocker or button with the function set to "Venetian blind", the ETS indicates the two 1-bit objects "Short-time operation" and "Long-time operation".

The status LEDs can be configured independently (see chapter 4.2.4.1.13. Status LED).

Operation concept for the Venetian blind function

For the control of Venetian blind, roller shutter, awning or similar drives, the push button sensor supports four operation concepts in which the telegrams are transmitted in different time sequences. The push button can therefore be used to operate a wide variety of drive configurations.

The different operation concepts are described in detail in the following chapters.

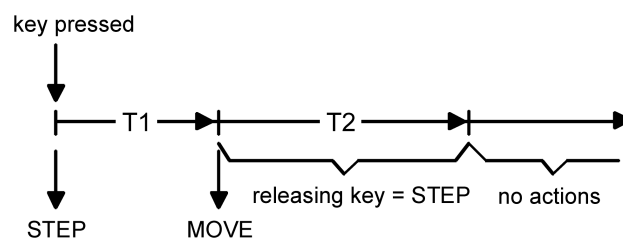

Figure 18: Operation concept "short – long – short"

Operation concept "short - long – short":

In the operation concept "short – long – short", the push button sensor shows the following behaviour:

- Immediately on pressing the button, the push button sensor transmits a short time telegram. Pressing the button stops a running drive and starts time T1 ("time between short time and long time command"). No other telegram will be transmitted, if the key is released within T1. This short time serves the purpose of stopping a continuous movement. The "time between short and long time command" in the push button sensor should be selected shorter than the short time operation of the actuator to prevent a jerky movement of the blind.
- If the button is kept depressed longer than T1, the push button sensor transmits a long time telegram after the end of T1 for starting up the drive and time T2 ("slat adjusting time") is started.
- If the button is released within the slat adjusting time, the push button sensor sends another short time telegram. This function is used for adjusting the slats of a blind. The function permits stopping the slats in any position during their rotation. The "slat adjusting time" should be chosen as required by the drive for a complete rotation of the slats. If the "slat adjusting time" is selected longer than the complete running time of the drive, a push button function is possible as well. This means that the drive is active only when the button is kept depressed.
- If the button is kept depressed longer than T2, the push button sensor transmits no further telegram. The drive remains on until the end position is reached.

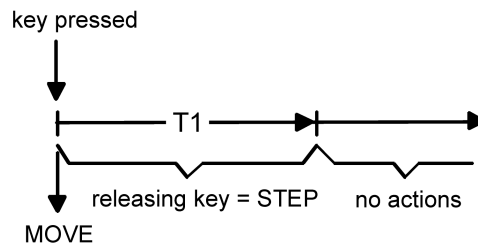

Figure 19: Operation concept "long – short"

Operation concept "long – short":

If the operation concept "long – short" is selected, the push button sensor shows the following behaviour:

- Immediately on pressing the button, the push button sensor transmits a long time telegram. The drive begins to move and time T1 ("slat adjusting time") is started.
- If the button is released within the slat adjusting time, the push button sensor transmits a short time telegram. This function is used for adjusting the slats of a blind. The function permits stopping the slats in any position during their rotation. The "slat adjusting time" should be chosen as required by the drive for a complete rotation of the slats. If the "slat adjusting time" is selected longer than the complete running time of the drive, a push button function is possible as well. This means that the drive is active only when the button is kept depressed.
- If the button is kept depressed longer than T1, the push button sensor transmits no further telegram. The drive remains on until the end position is reached.

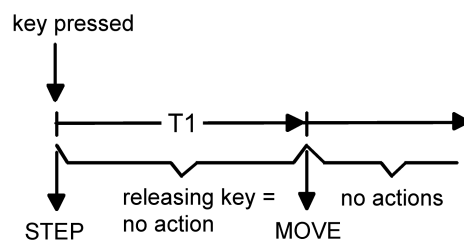

Figure 20: Operation concept "short – long"

Operation concept "short – long":

In the operation concept "short – long", the push button sensor shows the following behaviour:

- Immediately on pressing the button, the push button sensor transmits a short time telegram. Pressing the button stops a running drive and starts time T1 ("time between short time and long time command"). No other telegram will be transmitted, if the key is released within T1. This short time serves the purpose of stopping a continuous movement. The "time between short and long time command" in the push button sensor should be selected shorter than the short time operation of the actuator to prevent a jerky movement of the blind.
- If the button is kept depressed longer than T1, the push button sensor transmits a long time telegram after the end of T1 for starting the drive.
- No further telegram is transmitted when the button is released. The drive remains on until the end position is reached.

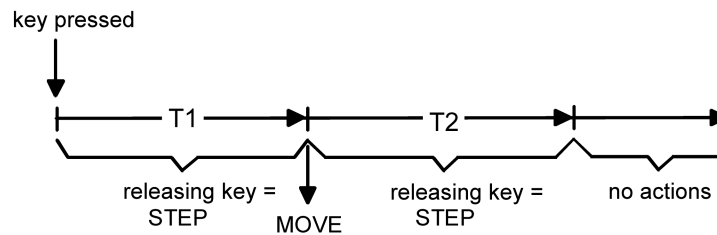

Figure 21: Operation concept "long – short or short"

Operation concept "long – short or short":

In the operation concept "long – short or short", the push button sensor shows the following behaviour:

- Immediately on pressing the button, the push button sensor starts time T1 ("time between short and long time command") and waits. If the button is released again before T1 has elapsed, the push button sensor transmits a short time telegram. This telegram can be used to stop a running drive. A stationary drive rotates the slats by one level.
- If the button is kept depressed after T1 has elapsed, the push button sensor transmits a long time telegram and starts time T2 ("slat adjusting time").
- If the button is released within T2, the push button sensor sends another short time telegram. This function is used for adjusting the slats of a blind. The function permits stopping the slats in any position during their rotation. The "slat adjusting time" should be chosen as required by the drive for a complete rotation of the slats. If the "slat adjusting time" is selected longer than the complete running time of the drive, a push button function is possible as well. This means that the drive is active only when the button is kept depressed.
- If the button is kept depressed longer than T2, the push button sensor transmits no further telegram. The drive remains on until the end position is reached.

i In this operation concept, the push button sensor will not transmit a telegram immediately after depressing one side of the rocker. This principle permits detecting a full-surface operation when the sensor is configured as a rocker.

Single-surface and double-surface operation in the blind function

As a rocker, the device is preprogrammed for double-surface actuation for the Venetian blind function. This means, for example, that the pushbutton sensor transmits a telegram for moving upwards on pressing the left button and a telegram for moving downwards on pressing the right button.

As a button, the device is preprogrammed for single-surface actuation for the Venetian blind function. In this case, the push button sensor alternates between the directions of the long time telegram (TOGGLE) on each long actuation of the sensor. Several short time telegrams in succession have the same direction.

The parameter "Command on pressing the button" or "Command on pressing the rocker" on the parameter pages of the buttons or rockers defines the single-surface or double-surface operation principle for the Venetian blind function.

For the button function, the command issued on pressing the button can basically be selected at the user's discretion.

Full-surface operation with Venetian blind function

When a rocker is configured for Venetian blind operation and if the operation concept "long – short or short" is used, the push button sensor needs some time at the beginning of each operation in order to distinguish between a short and a long operation. When full-surface operation is enabled, the push button sensor can make use of this time span to evaluate the otherwise invalid simultaneous actuation of both actuation points.

The pushbutton sensor detects a full-surface operation of a rocker if a control surface is depressed over a large area so that both buttons of the rocker are actuated.

When the pushbutton sensor has detected a valid full-surface actuation, the operation LED flashes quickly at a frequency of about 8 Hz for the duration of such actuation. Full-surface operation must have been detected before the first telegram has been transmitted by the

Venetian blind function (short time or long time). If this is not so, even a full-surface operation will be interpreted as a wrong operation and not be executed.

Full-surface actuation is independent. It has a communication object of its own and can optionally be used for switching (ON, OFF, TOGGLE – toggling of the object value) or for scene recall without or with storage function. In the last case, a press on the full surface causes a scene to be recalled in less than a second. If the push button sensor is to send the telegram for storing a scene, full-surface actuation must be maintained for more than five seconds. If full-surface actuation ends between the first and the fifth second, the push button sensor will not send any telegrams. If the status LEDs of the rocker are used as "button-press displays", they will light up for three seconds during transmission of the storage telegram.

i Full-surface actuation cannot be configured in the push button functions.

4.2.4.1.6 Value transmitter function

For each rocker or button with the function set to "1-byte value transmitter" or "2-byte value transmitter" the ETS indicates a corresponding object. On the press of a button, the configured value or the value last stored internally by a value change (see below) will be transmitted to the bus. In case of the rocker function, different values can be configured or varied for both buttons.

The status LEDs can be configured independently (see chapter 4.2.4.1.13. Status LED).

Value ranges

The "Function" parameter determines the value range used by the push button.

As a 1-byte value transmitter, the pushbutton sensor can optionally transmit integers from 0 ... 255 or relative values within a range of 0 ... 100 % (e.g. as dimming value transmitter).

As a 2-byte value transmitter, the pushbutton sensor can optionally transmit integers from 0 ... 65535, temperature values within a range of 0 ... 40 °C or brightness values from 0 ... 1500 lux.

For each of these ranges, the value that can be transmitted to the bus for each actuation of a rocker or button is configurable.

Adjustment by means of long button-press

If the value adjustment feature has been enabled in the ETS, the button must be kept depressed for more than 5 seconds in order to vary the current value of the value transmitter.

The value adjustment function continues to be active until the button is released again. In a value adjustment, the push button sensor distinguishes between the following options...

- The "Starting value in case of value adjustment" parameter defines the original starting value for the adjustment. Adjustment can begin from the value configured in the ETS, from the final value of the last adjustment cycle or from the current value of the communication object, with the last option not being available for the temperature and brightness value transmitter.
- The parameter "Direction of value adjustment" defines whether the values will always be increased ("upwards"), always reduced ("downwards") or alternately increased and reduced ("toggling").
- For the value transmitters 0 ... 255, 0 ... 100 % and 0 ... 65535, the "step width" by which the current value is to be changed during the value adjustment can be specified. In case of the temperature and the brightness value transmitter, the step width specifications (1 °C and 50 lux) are fixed.
- The parameter "Time between two telegrams" can be used in connection with the step width to define the time required to cycle through the full respective value range. This value defines the time span between two value transmissions.
- If, during the value adjustment, the push button sensor detects that the preset step width would result in the limits being exceeded with the next telegram, it adapts the step width once in such a way that the respective limit value is transmitted together with last telegram. Depending on the setting of the parameter "Value adjustment with overflow", the push button sensor stops the adjustment at this instance or inserts a pause consisting of two levels and then continues the adjustment beginning with the other limit value.

	Function	Lower numerical limit	Upper numerical limit
1-byte value transmitter	0...255	0	255
1-byte value transmitter	0...100 %	0 % (value = 0)	100 % (value = 255)
2-byte value transmitter	0...65535	0	65535
2-byte value transmitter	Temperature value	0 °C	40 °C
2-byte value transmitter	Brightness value	0 lux	1.500 lux

Table 1: Value range limits for the different value transmitters

- i** During a value adjustment, the newly adjusted values are only in the volatile RAM memory of the push button sensor. Therefore, the stored values are replaced by the preset values programmed in the ETS when a reset of the push button sensor occurs (bus voltage failure or ETS programming).
- i** During a value adjustment, the status LED of the corresponding button is switched off irrespective of configuration. The status LED will then light up for approx. 250 ms whenever a new value is transmitted.
- i** With the 1-byte value transmitter in the "Value transmitter 0...100 %" function, the step width of the adjustment will also be indicated in "%". If the starting value of the communication object is used, it may happen in this case during value adjustment that the value last received via the object must be rounded and adapted before a new value can be calculated on the basis of the step width and transmitted. Due to the computation procedure used, the new calculation of the value may be slightly inaccurate.

Value adjustment examples

Configuration example:

- Value transmitter 1-byte (all other value transmitters identical)
- Function = value transmitter 0...255
- Value configured in the ETS (0...255) = 227
- Step width (1...10) = 5
- Start on value adjustment = same as configured value
- Direction of value adjustment = toggling (alternating)
- Time between two telegrams = 0.5 s

Example 1: Value adjustment with overflow? = No

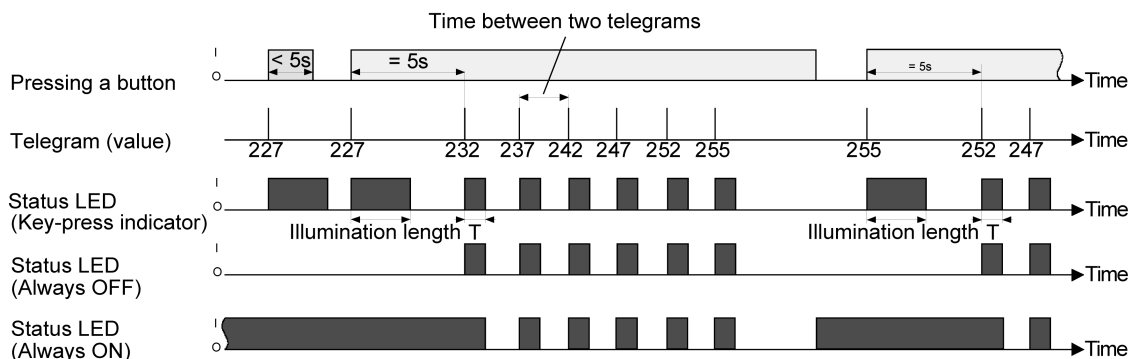

Figure 22: Example of value adjustment without value range overflow

Example 2: Value adjustment with overflow? = Yes

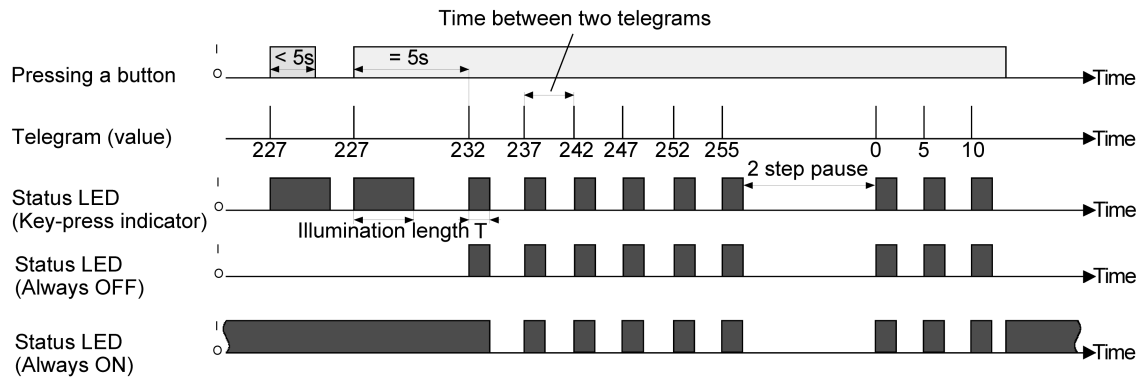

Figure 23: Example of value adjustment with value range overflow

4.2.4.1.7 Scene extension function

For each rocker or button with the function set to "scene extension unit" the ETS indicates the "Function" parameter which distinguishes between ...

- "Scene extension without store function",
- "Scene extension with storage function",
- "Recall internal scene without store function"
- "Recall internal scene with store function".

In the scene extension function, the push button sensor transmits a preset scene number (1...64) via a separate communication object to the bus after a button-press. This feature permits recalling scenes stored in other devices and also storing them, if the storage function is used.

The recall of an internal scene does not result in a telegram being transmitted to the bus. For this reason, the corresponding communication object is missing. This function can rather be used to recall – and with the storage function also to store – the up to 8 scenes stored internally in the device.

In the setting "... without store function", a button-press triggers the simple recall of a scene. If the status LED is configured as button-press display, it will be switched on for the configured ON time. A long button-press has no further or additional effect.

In the setting "... with storage function", the push button sensor monitors the length of the actuation. A button-press of less than a second results in a simple recall of the scene as mentioned above. If the status LED is configured as button-press display, it will be switched on for the configured ON time.

After a button-press of more than five seconds, the push button sensor generates a storage instruction. In the scene extension function, a storage telegram is in this case transmitted to the bus. If configured for the recall of an internal scene, the sensor will store the internal scene. An operation lasting between one and five seconds will be discarded as invalid.

The parameter "Scene number" specifies which of the maximum of 8 internal or 64 external scenes is to be used after a button-press. In case of the rocker function, two different scene numbers can be assigned.

The status LEDs can be configured independently (see chapter 4.2.4.1.13. Status LED).

4.2.4.1.8 2-channel operation function

In some situations it is desirable to control two different functions with a single button-press and to transmit different telegrams, i.e. to operate two function channels at a time. This is possible with the "2-channel operation" function.

For both channels, the parameters "Function channel 1" and "Function channel 2" can be used to determine the communication object types to be used. The following types are available for selection...

- Switching (1 bit)
- Value transmitter 0 ... 255 (1-byte)
- Value transmitter 0 ... 100 % (1-byte)
- Temperature value transmitter (2 bytes)

The object value the push button sensor is to transmit on a button-press can be selected depending on the selected object type. The "Switching (1 bit)" type permits selecting whether an ON or an OFF telegram is to be transmitted or whether the object value is to be switched over (TOGGLE) and transmitted on the press of a button.

The configuration as "Value transmitter 0 ... 255 (1 byte)" or as "Value transmitter 0 ... 100 % (1 byte)" permits entering the object value freely within a range from 0 to 255 or from 0% to 100%. The "Temperature value transmitter (2 bytes)" permits selecting a temperature value between 0°C and 40°C.

In this case, the adjustment of the object value on a long button-press is not possible as the determination of the actuation length is needed for the adjustable operation concepts.

Unlike in the other rocker and button functions, the application software assigns the "Telegram acknowledge" function instead of the "Button-press display" function to the status LED. In this mode, the status LED lights up for approx. 250 ms with each telegram transmitted. As an alternative, the status LEDs can be configured independently (see chapter 4.2.4.1.13. Status LED).

Operation concept channel 1 or channel 2

In this operation concept, exactly one telegram will be transmitted on each press of a button.

- On a brief press the push button sensor transmits the telegram for channel 1.
- On a long press the push button sensor transmits the telegram for channel 2.

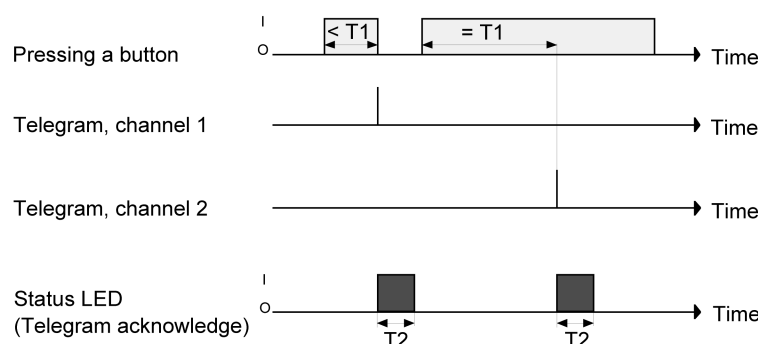

T1 = Time between channel 1 und channel 2
T2 = Illumination length for telegram acknowledge (approx. 250 ms)

Figure 24: Example of operation concept "Channel 1 or Channel 2"

The time required for distinguishing between a short and a long operation is defined by the parameter "Time between channel 1 and channel 2". If the button is pressed for less than the

configured time, only the telegram to channel 1 is transmitted. If the length of the button-press exceeds the time between channel 1 and channel 2, only the telegram to channel 2 will be transmitted. This concept provides the transmission of only one channel. To indicate that a telegram has been transmitted, the status LED lights up for approx. 250 ms in the "Telegram acknowledge" setting.

In this operation concept, the push button sensor will not transmit a telegram immediately after the rocker has been depressed. This principle also permits the detection of full-surface operation. The settings that are possible with full-surface operation are described below.

Operation concept channel 1 and channel 2

With this operation concept, one or alternatively two telegrams can be transmitted on each button-press.

- On a brief press the push button sensor transmits the telegram for channel 1.
- A long press causes the push button sensor to transmit first the telegram for channel 1 and then the telegram for channel 2.

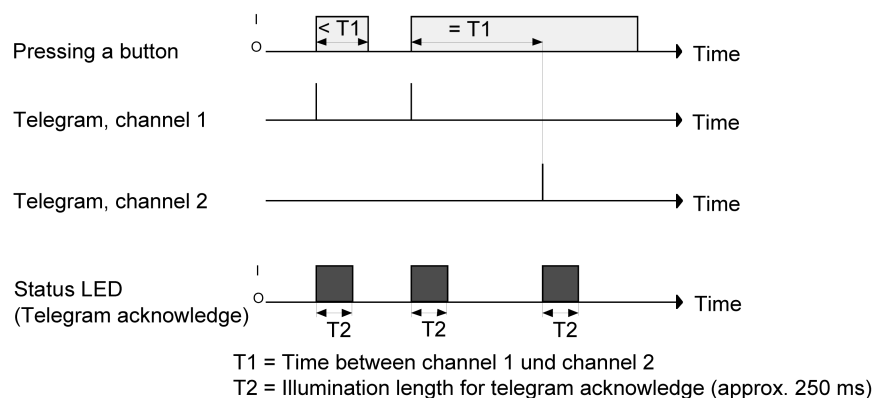

Figure 25: Example for operation concept "Channel 1 and channel 2"

The time required for distinguishing between a short and a long operation is defined by the parameter "Time between channel 1 and channel 2". In this operation concept, a button-press sends this telegram is immediately to channel 1. If the button is held depressed for the configured time, the telegram for the second channel is transmitted as well. If the button is released before the time has elapsed, no further telegram will be transmitted. This operation concept, too, offers the parameterizable possibility of having the transmission of a telegram signalled by the status LED (setting "Telegram acknowledge").

Full-surface operation with 2-channel operation

When a rocker is programmed for 2-channel operation and if the operation concept "channel 1 or channel 2" is used, the push button sensor needs some time at the beginning of each operation in order to distinguish between a short and a long operation. When full-surface operation is enabled, the push button sensor can make use of this time span to evaluate the otherwise invalid simultaneous actuation of both actuation points.

The pushbutton sensor detects a full-surface operation of a rocker if a control surface is depressed over a large area so that both buttons of the rocker are actuated.

When the pushbutton sensor has detected a valid full-surface actuation, the operation LED flashes quickly at a frequency of about 8 Hz for the duration of such actuation. The full-surface operation must have been detected before the first telegram has been transmitted by the 2-channel function. If this is not so, even a full-surface operation will be interpreted as a wrong operation and not be executed.

4.2.4.1.9 Controller extension function

The controller extension function can be activated to control a KNX/EIB room temperature controller. The controller extension function is enabled using the "Controller extension" setting of the parameter "Room temperature controller function" in the "Room temperature control" parameter node.

The controller extension is operated using the push button functions of the device. In this way, it is possible to completely control a room temperature controller by changing the operating mode, by predefining the presence situation or by readjusting the setpoint shift. For this purpose, the buttons of the push button sensor selected as extension operation buttons must be configured for the "Controller extension" function.

The operating function of the controller extension is described in detail in the chapter "Room temperature controller extension" .

- i It should be noted that an extension operation is possible with a button configuration. The controller extension function must be enabled in the "Room temperature control" parameter node. In all other cases, the controller extension function is not operational in the "push button sensor" function section.

4.2.4.1.10 "Fan control" function

The room temperature control can be supplemented with a fan controller. This makes it possible to control the fan from heating and cooling systems operated by circulating air, such as fan coil units (FanCoil units), depending on the command value calculated in the controller or using manual operation.

The fan controller distinguishes between Automatic and Manual operation. It is possible to change-over the fan operating mode and the fan operation using a button on the device, which is configured to the "Fan controller" function.

The operating function of the fan controller is described in detail in the chapter "Room temperature controller" (see page 143-144).

- i It should be noted that fan control is only possible with a button configuration. The fan controller must be enabled in the "Room temperature control -> Controller general" parameter node. Otherwise the fan control in the "Pushbutton sensor" function section has no function.

4.2.4.1.11 "Controller operating mode" function

The "Controller operating mode" push-button function can be used to control the internal room temperature controller. If this push-button function is used, it is possible to change over the operating mode by pressing the button. In the controller operating mode, a distinction is made between two functions, specified by the "Button function" parameter. On the one hand, the operating mode (Comfort, Standby, Night, Frost/heat protection) can be changed over and influenced ("Operating mode change-over" setting). On the other hand it is possible to activate the Presence function ("Presence button" setting). The Presence function allows activation of Comfort mode or a comfort extension on the internal controller.

The operating mode change-over and the presence function are described in detail in the chapter "Operating mode change-over" (see chapter 4.2.4.2.4. Operating mode switchover).

- i** It should be noted that the "Controller operating mode" function is only possible with a button configuration. The room temperature controller function must be enabled using the parameter of the same name in the "Room temperature control" parameter node. Otherwise the operation of the controller operating mode in the "Pushbutton sensor" function section has no function. In controller extension operation, the "Controller operating mode" push-button function also has no function. Here, the "Controller extension" push-button function can be used, allowing setting of the operating mode.

4.2.4.1.12 "Setpoint shift" function

The "Setpoint shift" push-button function can be used to control the internal room temperature controller. If this push-button function is used, it is possible to shift the setpoint temperature of the controller in a positive or negative direction by pressing the button.

The basic setpoint shift is described in detail in the chapter "Temperature setpoints" and "Operation" .

- i** It should be noted that the "Setpoint shift" function is only possible with a button configuration. The room temperature controller function must be enabled using the parameter of the same name in the "Room temperature control" parameter node. Otherwise the operation of the setpoint shift in the "Pushbutton sensor" function section has no function. In controller extension operation, the "Setpoint shift" push-button function also has no function. Here, the "Controller extension" push-button function can be used, allowing a setpoint shift.
- i** When a function button for the setpoint shift is pressed, the current shift is displayed on the device display in the same way as for operation using the display buttons. In addition, the hand icon  lights up in the display when there is an active shift. The adjusted temperature value is instantly accepted as the new setpoint when a function button is pressed. The setpoint shift display remains active for another 20 s after the last button actuation. In contrast to the setpoint shift using the display buttons, the setpoint shift display does not switch back to the basic display when any other function button is actuated. In addition, the setpoint shift display is not terminated prematurely on a switchover of the display using the communication object of the same name. Pressing other function buttons during the 20 s display time of the setpoint shift cause the stored functions (e.g. switching, dimming, Venetian blind, etc.) to be executed!

4.2.4.1.13 Status LED

Each button on the device has a Status LED (exception: display buttons). Depending on the configuration of the rockers or buttons, the possible LED functions available differ slightly.

Each status LED distinguishes the following options...

- Always OFF,
- always ON,
- Control via separate LED object,
- Comparator without sign (1 byte),
- Comparator with sign (1 byte)

These options are generally available even if the buttons have no function assigned.

If a function has been assigned to the rocker or button, the ETS displays moreover the option...

- Button-press display,

...which in the function "2-channel operation" is replaced by...

- Telegram acknowledgment

...ersetzt wird.

If the rocker or the button is used for switching or dimming or to control the fan or setpoint shift, the following options...

- Status indication,
- Inverted status display.

...can be set.

In addition, the Status LEDs may possess the following option, if a controller extension, a fan controller, a controller operating mode switchover or a setpoint shift is not configured ...

- Operating mode indication (KNX controller).

If a button is used for the operation of a controller extension and the "Presence button" function is used, then...

- Button function active / inactive display

...can be set.

i Besides the functions that can be set separately for each status LED, all status LEDs are also used together with the operation LED for alarm signalling. If this is active, all LEDs of the push button sensor flash simultaneously. After deactivation of the alarm signalling, all LEDs will immediately return to the state corresponding to their configuration and communication objects.

Status LED function "always OFF" or "always ON"

A status LED used as button-press display is switched on by the pushbutton each time the corresponding rocker or button is pressed. The parameter "ON time of status LEDs as actuation displays" on the parameter node "General" specifies for how long the LED is switched on in common for all status LEDs. The status LED lights up when the rocker or button is pressed even if the telegram is transmitted by the sensor only when the button or rocker is released.

With the function "2-channel operation" the option "Button-press display" is replaced by "Telegram acknowledge". In this case the status LED is illuminated when both channels are

transmitted for about 250 ms each.

Function of the status LED "Control via separate LED object", "Status display", and "Inverted status display"

Each status LED can indicate the status of a separate LED communication object independently of the rocker or pushbutton configuration. Here the LED can be switched on or off statically via the received 1-bit object value, or also activated by flashing. Each status LED can indicate the state of a separate LED communication object independently of the rocker or pushbutton configuration. Here the LED can be switched on or off statically via the 1-bit object value received, or also activated as flashing.

Additionally, the status LEDs can be linked in the rocker or button functions "Switching" or "Dimming" also with the object used for switching and thus signal the current switching state of the actuator group. In this LED setting, an active function can be signalled using the functions "Fan control" or "Setpoint shift". With fan control, the status LED is then controlled either in Automatic or Manual mode according to the push-button function. With a setpoint shift, the LED signals an active shift in a positive or negative direction.

For the status indications, there is also the option of displaying the active status in inverted form.

After a device reset, the value of an LED object is always "OFF".

Function of status LED as "operating mode display (KNX controller)"

For switching over between different modes of operation, new room temperature controller can make use of two communication objects of the 20.102 "HVAC-Mode" data type. One of these objects can switch over with normal priority between the "Comfort", "Standby", "Night", "Frost/heat protection" operating modes. The second object has a higher priority. It permits switching over between "Automatic", "Comfort", "Standby", "Night", "Frost/heat protection". Automatic means in this case that the object with the lower priority is active.

If a status LED is to indicate the operating mode, the communication object of the status LED must be linked with the matching object of the room temperature controller. The desired operating mode which the LED is to indicate can then be selected with the parameter "Status LED on with". The LED is then lit up when the corresponding operating mode has been activated at the controller.

After a device reset, the value of the LED object is always "0" (Automatic).

Function of status LED as "comparator"

The status LED can indicate whether a configured comparison value is greater than, equal to or less than the 1-byte object value of the status object. This comparator can be used for unsigned (0 ... 255) or for signed integers (-128 ... 127). The data format of the comparison is defined by the function of the status LED.

The status LED lights up only if the comparison is "true".

i After a device reset, the value of the LED object is always "0".

4.2.4.1.14 Disabling function

Disabling function configuration

With the 1-bit communication object "B.Button disabling", the sensor surfaces of the push button sensor can be partly or completely disabled. During a disable, the rockers or buttons can also temporarily execute other functions.

An active disable applies only to the functions of the rockers or buttons. The functions of the status LED, room temperature control, scene function and the alarm message are not affected by the disabling function.

The disabling function and the pertaining parameters and communication objects are enabled if the parameter "Disabling function ?" in the parameter node "Disable" is set to "Yes".

You can parameterize the polarity of the disabling object. In case of polarity inversion (disabled = 0 / enabled = 1), the disabling function is not activated immediately after a device reset (object value = "0"). There must first be an object update "0" until the disabling function will be activated.

- i** During an active disable, the Disable icon  is lit up on the display.
- i** Telegram updates from "0" to "0" or from "1" to "1" on the "button disabling" object remain without effect.

Configuring the reaction at the beginning and end of a disable.

If the disabling function is used, the reaction of the pushbutton sensor on activation and deactivation of the disabling function can be preset separately in the parameters of the pushbutton sensor (parameter "Reaction of pushbutton sensor at the beginning / end of disabling"). In this connection it is irrelevant which of the sensor surfaces is influenced and possibly also locked by disabling. The pushbutton sensor always shows the configured behaviour.

The disabling function must have been enabled in advance.

- Set the parameter "Reaction of pushbutton sensor at the beginning / end of disabling" to "No reaction".

The pushbutton sensor shows no reaction at the beginning and at the end of disabling. The sensor only adopts the state as provided for by the "Behaviour during active disabling".

- Set the parameter "Reaction of pushbutton sensor at the beginning / end of disabling" to "Internal scene recall scene 1 ...8".

The pushbutton sensor recalls one of the up to 8 internal scenes. Scene storage is not possible.

- Set the parameter "Reaction of pushbutton sensor at the beginning / end of disabling" to "Reaction as button >> X << / >> Y << when pressed / released".

The push-button sensor executes the function assigned to any "target button" in the non-disabled state. Target buttons are operating buttons of the pushbutton sensor which may be configured for rocker or for button operation. The target buttons are configured separately for the beginning (X) of for the end (Y) of disabling. Both buttons of a rocker are always treated as two separate buttons.

The action configured for the respective target button is executed. If the target button is configured in such a way that it has no function or does not transmit a telegram on pressing or releasing of the button, then there is also no reaction to disabling or to re-enabling. If the selected target button is part of a configured rocker, the behaviour preset for the respective rocker side (left rocker or right) will be used. The telegrams are transmitted to the bus via the required communication object of the target button.

The following table shows all possible telegram reactions of the pushbutton sensor with respect to the target button function.

Function of >>target button<<	Reaction "as >>target button<< on pressing"	Reaction "as >>target button<< on releasing"
Switching / toggling	Switching telegram	Switching telegram
Dimming	Switching telegram	No telegram
Venetian blind	Long time telegram	No telegram
Scene extension	Scene recall telegram	No telegram
1-byte value transmitter	Value telegram	No telegram
2-byte value transmitter	Value telegram	No telegram
Temperature value transmitter	Temperature value telegram	No telegram
Brightness value transmitter	Brightness value telegram	No telegram
2-channel operation Channel 1: 1-bit object type	Switching telegram	No telegram
2-channel operation Channel 1: 1-byte object type	Value telegram	No telegram
2-channel operation Channel 1: 2-byte object type	Temperature value telegram	No telegram
Controller extension Operating mode switchover	Operating mode telegram	No telegram
Controller extension Motion detection	Presence telegram	No telegram
Controller extension Setpoint shift	Level value telegram	No telegram
No function	No telegram	No telegram

Table 2: Telegram reactions of the pushbutton sensor with respect to the target push-button function

- i** The display buttons cannot be configured as target buttons at the beginning or end of a disable.
- Set the parameter "Reaction of pushbutton sensor at the beginning / end of disabling" to "Reaction as disabling function 1 / 2 when pressed / released".
The pushbutton sensor executes the function assigned to either of the two "virtual" disabling functions. The disabling functions are internal button functions with independent communication objects and independent parameters. Except for the status LED, the setting possibilities available for disabling function 1 and disabling function 2 are the same as for the buttons.
The respective configuration of the predefined disabling function will be executed. If no function or no telegram is configuration in the disabling function on pressing or releasing of a button, then there is also no reaction to disabling or to re-enabling.
Also, for this setting, Table 2 shows all possible telegram reactions of the pushbutton sensor depending on the configuration of the disabling function.
The telegrams are transmitted to the bus via the required communication object of the disabling function.

Configuring the behaviour during a disable.

Irrespective of the behaviour shown by the pushbutton sensor at the beginning or at the end of disabling, the control buttons can be separately influenced during disabling.

The disabling function must have been enabled in advance.

- Set the parameter "Behaviour during active disabling" to "all buttons without function".

In this case, the push button sensor, including the display buttons, is completely locked during disabling. Pressing a button has no effect. The status LEDs of the disabled buttons are without function (no button-press display either). Only the "Always ON" or "Always OFF" state remains unaffected by the disabling function.

- Set the parameter "Behaviour during active disabling" to "all buttons behave like". Continue to configure the parameters "During disable, all right / left buttons behave like" to the required button number or disabling function.

All buttons behave as defined in the parameters for the two specified reference buttons of the pushbutton sensor. Different or identical reference buttons can be configured separately for all the left and right operating buttons. The two "virtual" disabling functions of the push button sensor can also be configured as a reference button.

The telegrams are transmitted to the bus via the communication objects of the specified reference buttons. The status LEDs of the reference buttons are controlled according to their function. The status LEDs of the disabled buttons are without function (no button-press display either). Only the "Always ON" or "Always OFF" state remains unaffected by the disabling function.

- Set the parameter "Behaviour during active disabling" to "Individual buttons without function". In the "Disable - Button selection" parameter node, specify the buttons to which the disable is to apply.

Only the individually specified buttons are locked during disabling. The other control buttons remain unaffected by disabling. The status LEDs of the disabled buttons are without function (no button-press display either). Only the "Always ON" or "Always OFF" state remains unaffected by the disabling function. In this setting, the display buttons can only be jointly disabled.

- Set the parameter "Behaviour during active disabling" to "Individual buttons behave like". In the "Disable - Button selection" parameter node, specify the buttons to which the disable is to apply. Continue to configure the parameters "During disable, all right / left buttons behave like" to the required button number or disabling function.

Only the individually specified buttons behave as defined in the parameters of the two specified reference buttons of the pushbutton sensor. Different or identical reference buttons can be configured separately for all the left and right operating buttons. The two "virtual" disabling functions of the push button sensor can also be configured as a reference button. The buttons that will be disabled are defined in the parameters on the "Disable - buttons selection" parameter node.

The telegrams are transmitted to the bus via the communication objects of the specified reference buttons. The status LEDs of the reference buttons are controlled according to their function. The status LEDs of the disabled buttons are without function (no button-press display either). Only the "Always ON" or "Always OFF" state remains unaffected by the disabling function. In this configuration, the display buttons can be allocated to the Disable function independently of one another, allowing, for example, the display buttons to execute any other push button sensor function. If an undischarged display button carries out a setpoint shift, or the second operating level was activated using a double button-press, then the originally disabled display button is enabled and temporarily reassigned to the display function for the time the setpoint shift is displayed or the second operating level.

- i** If a button evaluation is taking place at the time of activation / deactivation of a disabling function, this function is aborted immediately and with it also the pertaining button function. It is first necessary to release all buttons before a new button function can be executed if so permitted by the state of disabling.

4.2.4.1.15 Transmission delay

After a reset (e.g. after loading of an application program or the physical address or after switch-on of the bus voltage), the device can automatically transmit telegrams for the "Controller extension" function. The controller extension then attempts to retrieve values from the room temperature controller by means of read telegrams in order to update the object states (see chapter 4.2.4.3.5. Behaviour after a device restart). This update takes place for all the transmitting objects with the name "B.Controller extension" and additionally for the objects "D.Input controller ext. status signal addition" and "D.Input controller ext. ventilation visualisation".
After a device reset, the telegrams for room temperature measurements are also automatically transmitted to the bus.

If, in addition to the pushbutton sensor, there are still other devices installed in the bus which transmit telegrams immediately after a reset, it may be useful to activate the transmit delay for automatically transmitting objects of the controller extension and the room temperature measurement in the "General" parameter node in order to reduce the bus load.
When transmit delay is activated, the push button sensor determines the value of its individual delay from the device number of its physical address (phys. address: area.line.device number). This value can be about 30 seconds maximum. Without setting a special time delay, this principle prevents multiple push button sensors from trying to transmit telegrams to the bus at the same time.

- i** The transmit delay is not active for the rocker and button functions of the push button sensor. In addition, the controller objects are not influenced by the transmission delay.

4.2.4.1.16 Alarm signal

The push button sensor permits signalling of an alarm which might be, for instance, a burglar or a fire alarm from a KNX/EIB central alarm unit. An alarm is signalled by all status LEDs and of the operation LED of the pushbutton sensor flashing synchronously. The alarm can be separately enabled with the parameter "Alarm signal display" on parameter node "Alarm signalling" so that it can be used.

When alarm signalling is enabled, the ETS displays the communication object "B.Alarm signalling" and further alarm function parameters.

The alarm signalling object is used as an input for activating or deactivating alarm signal displaying. The polarity of the object can be selected. When the object value corresponds to the "Alarm" condition, all status LEDs and the operation LED are always flashing with a frequency of approx. 2 Hz. If there is an alarm, the basic parameterisations of the LED have no significance. The LEDs adopt their originally configured behaviour only after the alarm signalling function has been deactivated. Changes of the state of the LEDs during an alarm - if they are controlled by separate LED objects or if they signal push-button functions - are internally stored and recovered at the end of the alarm.

Apart from the possibility of deactivating an alarm signal via the alarm object, it can also be deactivated locally by a button-press on the push button sensor itself. The "Reset alarm signalling by a button-press?" parameter defines the button response during an alarm...

- If this parameter is set to "Yes", active alarm signal displaying can be deactivated by a button-press on the push button sensor (also using display buttons). This button-press does not cause the configured function of the pressed button to be executed. Only after the next button-press will the configuration of the button be evaluated and a telegram be transmitted to the bus, if applicable.
- If "No" has been selected, alarm signalling can only be deactivated via the alarm signalling object. A button-press will always directly execute the configured button function.

If alarm signalling can be deactivated by a button-press, the parameter "Acknowledge alarm signalling by" defines whether an additional alarm acknowledge telegram is to be transmitted to the bus via the separate object "Alarm signalling acknowledge" after triggering by this button-press.

Such an acknowledge telegram can, for instance, be sent via a 'listening' group address to the "Alarm signalling" objects of other push button sensors in order to reset the alarm status there as well. Attention must be paid during resetting of an alarm to the selectable polarity of the acknowledge object.

- i** Notes on the polarity of the alarm object: if the setting is "Alarm when OFF and alarm reset when ON", the alarm object must be actively written by the bus with "0" to activate the alarm after a device reset.
- i** An active alarm signal is not stored so that the display alarm is generally deactivated after a device reset.
- i** If there is a display alarm, the backlighting of the display does not flash.
- i** A newly incoming alarm signal is not indicated, if a setpoint shift or the second operating level are shown on the display at this time. The alarm is only then displayed when the operation of the setpoint shift or the second operating level was terminated manually or after a set time.

4.2.4.2 Room temperature controller

The glass sensor can be used for single-room temperature control. Depending on the operating mode, the current temperature setpoint and on the room temperature, command values for heating or cooling control and fan control can be sent to the KNX/EIB. Usually, these command values are then converted by a suitable KNX/EIB actuator, e.g. heating or switching actuators or directly by bus-compatible actuating drives, evaluated and converted to physical variables for air conditioning control.

The room temperature control is an independent function section of the glass sensor. It has its own parameter and object range in the ETS configuration. Therefore, the room temperature controller can be switched on or off, irrespective of the push button sensor function.

The controller function section of the glass sensor can either work as a main controller or as a controller extension. As the main controller, the room temperature controller function is fully switched on and the control algorithm activated. Only the main controller transmits control value telegrams. A controller extension itself is not involved in the regulating process. With it, the user can operate the single-room controller, i.e. the main controller from different places in the room. In this way, any number of operating extensions can be set up.

In this chapter, the functions of the room temperature controller are described as a main controller.

4.2.4.2.1 Operating modes and operating mode change-over

Introduction

The room temperature controller distinguishes between two different operating modes. The operating modes specify whether you want the controller to use its variable to trigger heating systems ("heating" single operating mode) or cooling systems ("cooling" single operating mode). You can also activate mixed operation, with the controller being capable of changing over between "Heating" and "Cooling" either automatically or, alternatively, controlled by a communication object.

In addition, you can establish two-level control operation to control an additional heating or cooling unit. For two-level feedback control, separate command values will be calculated as a function of the temperature deviation between the setpoint and the actual value and transmitted to the bus for the basic and additional levels. The parameter "Controller operating mode" in the "Room temperature control -> Controller general" parameter branch specifies the operating mode and, if necessary, enables the additional level(s).

"Heating" or "cooling" single operating modes

In the single "Heating" or "Cooling" operating modes without any additional level, the controller will always work with one command value and, alternatively, when the additional level is enabled, it will use two command value in the configured operating mode. Depending on the room temperature determined and on the specified setpoint temperatures of the operating modes (see chapter 4.2.4.2.4. Operating mode switchover), the room temperature controller will automatically decide whether heating or cooling energy is required and calculates the command value for the heating or cooling system.

"Heating and cooling" mixed operating mode

In the "Heating and cooling" mixed operating mode, the controller is capable of triggering heating and cooling systems. In this connection, you can set the change-over behaviour of the operating modes...

- "Change over between heating and cooling" parameter in the "Room temperature control -> Controller general" parameter branch set to "Automatic".
In this case, a heating or cooling mode will be automatically activated, depending on the room temperature determined and on the given temperature basic setpoint, or on the deadband, respectively. If the room temperature is within the preset deadband neither heating nor cooling will take place (both command values = "0"). In this connection, the display will read the heating temperature setpoint of the activated operating mode when you actuate the display buttons. If the room temperature is higher than the cooling temperature setpoint cooling will take place. If the room temperature is lower than the cooling temperature setpoint heating will take place.
When the heating/cooling operating mode is changed over automatically, the information can be actively sent to the bus via the object "Heating/cooling change-over" to indicate whether the controller is working in the heating mode ("1" telegram) or in the cooling mode ("0" telegram). In this connection, the "Automatic heating/cooling change-over transmission" parameter specifies when an operating mode change-over will be transmitted...
Setting "On changing the operating mode": in this case, a telegram will be transmitted solely on change-over from heating to cooling (object value = "0") or from cooling to heating (object value = "1"), respectively.
- Setting "On changing the output command value": with this setting, the current operating mode will be transmitted whenever there is a modification of the output command value. If the command value = "0" the operating mode which was active last will be transmitted. If the room temperature determined is within the deadband, the operating mode activated last will be retained in the object value until a change-over to the other operating mode takes place, if necessary. In addition, the object value can be output in cycles when automatic switch-over is being made.
The "Cyclical transmission heating/cooling change-over" parameter enables cyclic transmission (factor > "0" setting) and specifies the cycle time.
With an automatic operating mode change-over, it should be noted that under certain circumstances there will be continuous change-over between heating and cooling if the deadband is too small. For this reason, you should, if possible, not set the deadband (temperature difference between the setpoint temperatures for the comfort heating and cooling modes) below the default value (2 K).

- "Change-over between heating and cooling" parameter in the "Room temperature control -> Controller general" parameter branch set to "Via object".
In this case, the operating mode is controlled via the object "Heating/cooling change-over", irrespective of the deadband. This type of change-over can, for example, become necessary if both heating and cooling should be carried out through a one-pipe system (heating and cooling system). For this, the temperature of the medium in the single-pipe system must be changed via the system control. Afterwards the heating/cooling operating mode is set via the object (often the single-pipe system uses cold water for cooling during the summer, hot water for heating during the winter).
The "Heating/cooling change-over" object has the following polarities: "1": heating; "0" cooling. After a reset, the object value will be "0", and the "Heating/cooling operating mode change-over after reset" set in the ETS will be activated. You can use the "Heating/cooling operating mode after reset" parameter to set which mode you want to activate after a reset. For the "Heating" or "Cooling" settings, the controller will activate the configured heating/cooling operating mode immediately after the initialisation phase. In case of parameterisation "Operating mode before reset" the operating mode which was selected before the reset will be activated.
If a change-over is made through the object the operating mode will first be changed into the one specified to be activated after a reset. A change-over to the other operating mode will only take place after the device receives an object update, if necessary.
Notes on the setting "Operating mode before reset": frequent changing of the operating mode (e. g. several times a day) during running operation can adversely affect the life of the device as the read-only memory (EEPROM) used has been designed for less frequent write access events only.

It is not possible to heat and cool at the same time (command value > "0"). Only with PWM is it possible that a short-time 'command value overlapping' could occur during the transition between heating and cooling, due to the matching of the command value at the end of a time cycle. However, such overlapping will be corrected at the end of a PWM time cycle. Only if heating or cooling energy is required in one of the operating modes and, consequently, the command value is > "0" the " */// " or " -/// " icon will appear on the display.

Heating/cooling message

Depending on the set operating mode, separate objects can be used to signal whether the controller is currently demanding heating or cooling energy and is thus actively heating */// or cooling -///. As long as the heating command value is > "0", a "1" telegram will be transmitted through the "Heating" signal object. The signal telegram is only reset when the command value is "0" ("0" telegram is transmitted). The same applies to the signal object for cooling.

- i** With 2-point feedback control, it should be noted that the */// or -/// icons will light up on the display or that the message objects for heating and cooling will already become active as soon as the temperature falls short of the temperature setpoint of the active operating mode in case of heating or exceeds the temperature setpoint in case of cooling. In this case, the configured hysteresis is not taken into account.

The signal objects can be enabled by the "Heating message" or "Cooling message" parameters in the "Room temperature control -> Command value and status output" parameter branch. The control algorithm controls the signal objects. Please note that the command value is recalculated every 30 s, followed by an updating of the signal objects.

4.2.4.2.2 Control algorithms and calculation of command values

Introduction

To facilitate convenient temperature control in living or business spaces a specific control algorithm which controls the installed heating or cooling systems is required. Taking account of the preset temperature setpoints and the actual room temperature, the controller thus determines command values which trigger the heating or the cooling system. The control system (control circuit) consists of a room temperature controller, an actuator or switching actuator (when ETD electrothermal drives are used), the actual heating or cooling element (e. g. radiator or cooling ceiling) and of the room. This results in a controlled system (Figure 26).

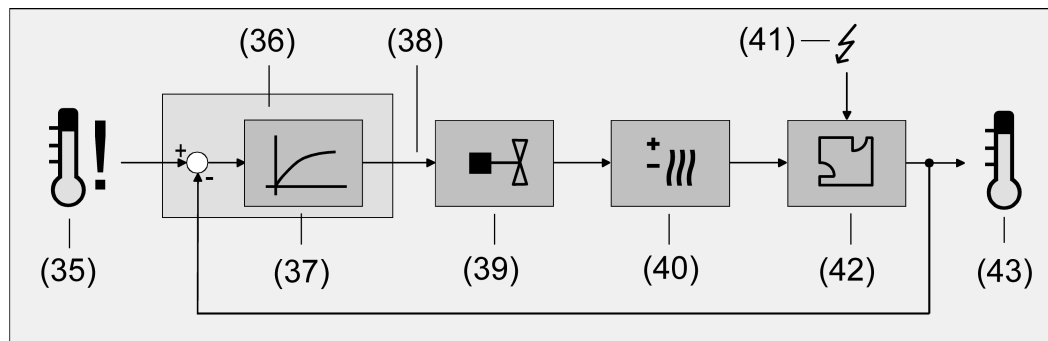

Figure 26: Controlled system of single-room temperature control

- (35) Setpoint temperature specification
- (36) Room temperature controller
- (37) Control algorithm
- (38) Command value
- (39) Valve control (actuating drive, ETD, heating actuator, ...)
- (40) Heat / cold exchanger (radiator, cooling ceiling, FanCoil, ...)
- (41) Fault variable (sunlight penetration, outdoor temperature, illumination systems, ...)
- (42) Room
- (43) Actual temperature (room temperature)

The controller measures the actual temperature (43) and compares it with the given setpoint temperature (35). With the aid of the selected control algorithm (37), the command value (38) is then calculated from the difference between the actual and the setpoint temperature. The command value controls valves or fans for heating or cooling systems (39), meaning that heating or cooling energy in the heat or cold exchangers (40) is passed into the room (42). Regular readjustment of the command value means that the controller is able to compensate for setpoint / actual temperature differences caused by external influences (41) in the control circuit. In addition, the flow temperature of the heating or cooling circuit influences the control system which necessitates adaptations of the variable.

The room temperature controller facilitates either proportional/integral (PI) feedback control as a continuously working or switching option, or, alternatively, switching 2-point feedback control. In some practical cases, it can become necessary to use more than one control algorithm. For example, in bigger systems using floor heating, one control circuit which solely triggers the floor heating can be used to keep the latter at a constant temperature. The radiators on the wall, and possibly even in a side area of the room, will be controlled separately by an additional level with its own control algorithm. In such cases, distinction must be made between the different types of control, as floor heating systems, in most cases, require control parameters which are different to those of radiators on the wall, for example. It is possible to configure up to four independent control algorithms in two-level heating and cooling operation.

The command values calculated by the control algorithm are output via the "Heating command

value" or "Cooling command value" communication objects. Depending on the control algorithm selected for the heating and/or cooling mode, the format of the command value objects is, among other things, also specified. 1-bit or 1-byte actuating objects can be created in this way (see chapter 4.2.4.2.7. Command value and status output). The control algorithm is specified by the parameters "Type of heating control" or "Type of cooling control" in the "Room temperature control -> Controller general" parameter branch and, if necessary, also with a distinction of the basic and additional stages.

Continuous PI control

PI control is an algorithm which consists of a proportional part and an integral part. Through the combination of these control properties, you can obtain room temperature control as quickly and precisely as possible without or only with low deviations.

When you use this algorithm, the room temperature controller will calculate a new continuous command value in cycles of 30 seconds and send it to the bus via a 1-byte value object if the calculated command value has changed by a specified percentage. You can use the "Automatic transmission on change by..." parameter in the "Room temperature control -> Command value and status output" parameter branch to set the change interval in percent.

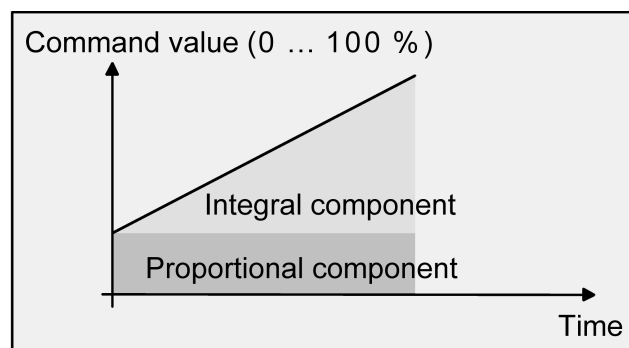

Figure 27: Continuous PI control

An additional heating or cooling level as PI control works in the same way as the PI control of the basic level, with the exception that the setpoint will shift, taking account of the configured level width.

Special features of the PI control:

If the room temperature deviation between the actual value and the setpoint is high enough to have a 100 % command value the room temperature controller will work with this maximum control value until the room temperature measured has reached its setpoint. This particular behaviour is known as 'clipping'. This way, rapid heating up of undercooled rooms or quick cooling in overheated rooms will be achieved. In two-stage heating or cooling systems, this control behaviour also applies to the variables of the additional stages.

Switching PI control

With this type of feedback control, the room temperature will also be kept constant by the PI control algorithm. Taking the mean value for a given time, the same behaviour of the control system will result as you would obtain with a continuous controller. The difference compared with continuous feedback control is only the way how the command value is output. The command value calculated by the algorithm in cycles of every 30 seconds is internally converted into a pulse-width-modulated (PWM) command value signal and sent to the bus via a 1-bit switching object after the cycle time has elapsed. The mean value of the command value signal resulting from this modulation is a measure for the averaged position of the control valve,

thus being a reference to the room temperature set, taking account of the cycle time which you can set through the "Cycle time of the switching command value..." parameter in the "Room temperature control -> Command value and status output" parameter branch.

A shift of the mean value, and thus a change in the heating capacity, can be obtained by changing the duty factor of the switch-on and switch-off pulses of the command value signal. The duty factor will be adapted by the controller only at the end of a time period, depending on the command value calculated. This applies to any change of the command value, regardless of what the ratio is by which the command value changes (the "Automatic transmission on change by..." and "Cycle time for automatic transmission..." parameters will have no function in this case).

Each command value calculated last during an active time period will be converted. Even after you have changed the setpoint temperature, for example, by switching over the operating mode, the command value will still be adapted after the end of an active cycle time. The diagram below shows the command value switching signal output according to the internally calculated command value (first of all, a command value of 30 %, then of 50 %, with the command value output not being inverted).

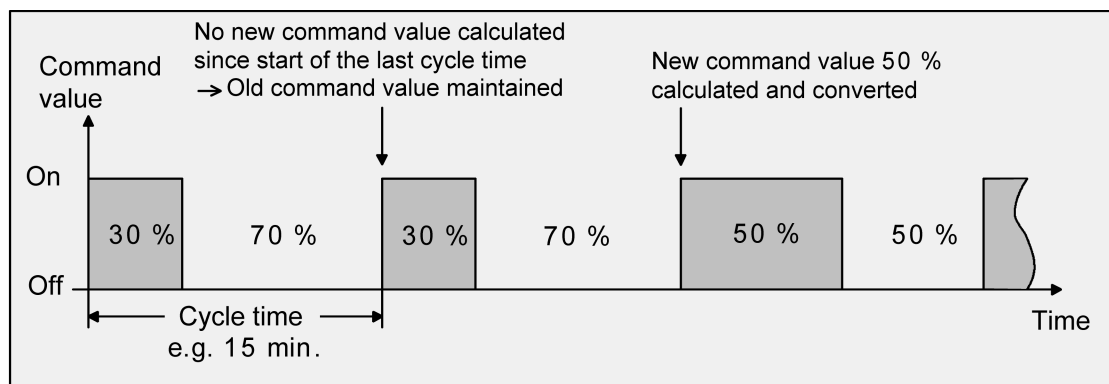

Figure 28: Switching PI control

For a command value of 0 % (permanently off) or of 100 % (permanently on), a command value telegram corresponding to the command value ("0" or "1") will always be sent after a cycle time has elapsed. 'Clipping' (see page 98) will also be active for this type of control.

For switching PI control, the controller will always use continuous command values for internal calculation. Such continuous values can additionally be sent to the bus via a separate 1-byte value object, for example, as status information for visualisation purposes (if necessary, also separately for the additional levels). The status value objects will be updated at the same time as the command value is output and will only take place after the configured cycle time has elapsed. The parameters "automatic transmission on change by..." and "Cycle time for automatic transmission..." parameters will have no function in this case. An additional heating or cooling level as switching PI control works in the same way as the PI control of the basic stage, with the exception that the setpoint will shift, taking account of the configured level width. All PWM control options will use the same cycle time.

Cycle time:

The pulse-width-modulated command values are mainly used for activating electrothermal drives (ETD). In this connection, the room temperature controller sends the switching command values telegrams to a switching actuator equipped with semiconductor switching elements which the drives are connected to (e.g. heating actuator or room actuator). By setting the cycle time of the PWM signal on the controller, you can adapt the feedback control to the drives used. The cycle time sets the switching frequency of the PWM signal and allows adaptation to the adjusting cycle times of the actuators used (the adjusting time it takes the drive to bring the valve from its completely closed to its completely opened position). In addition to the adjusting cycle time, take account of the dead time (the time in which the actuators do not show any

response when being switched or off). If different actuators with different adjusting cycle times are used, take account of the longest of the times. Always note the information given by the manufacturers of the actuators.

During cycle time configuration, a distinction can always be made between two cases...

Case 1: Cycle time $> 2 \times$ adjusting cycle time of the electrothermal drives used (ETD)

In this case, the switch-on or switch-off times of the PWM signal are long enough for the actuators to have sufficient time to fully open or fully close within a given time period.

Advantages:

The desired mean value for the command value and thus for the required room temperature will be set relatively precisely, even for several actuators triggered at the same time.

Disadvantages:

It should be noted, that, due to the full valve lift to be continuously 'swept', the life expectancy of the actuators can diminish. For very long cycle times (> 15 minutes) with less sluggishness in the system, the heat emission into the room, for example, in the vicinity of the radiators, can possibly be non-uniform and be found disturbing.

- i** This setting is recommended for sluggish heating systems (such as underfloor heating).
- i** Even for a bigger number of triggered actuators, maybe of different types, this setting can be recommended to be able to obtain a better mean value of the adjusting travels of the valves.

Case 2: Cycle time $<$ adjusting cycle time of the electrothermal drives used (ETD)

In this case, the switch-on or switch-off times of the PWM signal are too short for the actuators to have enough time to fully open or fully close within a given period.

Advantages:

This setting ensures continuous water flow through the radiators, thus facilitating uniform heat emission into the room.

If only one actuator is triggered the controller can continuously adapt the command value to compensate the mean value shift caused by the short cycle time, thus setting the desired room temperature.

Disadvantages:

If more than one drive is triggered at the same time the desired mean value will become the command value, which will result in a very poor adjustment of the required room temperature, or in adjustment of the latter with major deviations, respectively.

The continuous flow of water through the valve, and thus the continuous heating of the drives causes changes to the dead times of the drives during the opening and closing phase. The short cycle time and the dead times means that the required variable (mean value) is only set with a possibly large deviation. For the room temperature to be regulated constantly after a set time, the controller must continually adjust the command value to compensate for the mean value shift caused by the short cycle time. Usually, the control algorithm implemented in the controller (PI control) ensures that control deviations are compensated.

- i** This setting is recommended for quick-reaction heating systems (such as surface radiators).

2-point feedback control

The 2-point control represents a very simple temperature control. For this type of feedback control, two hysteresis temperature values are set. The actuators are triggered by the controller

via switch-on and switch-off command value commands (1-bit type). A continuous command value is not calculated for this type of control.

The room temperature is also evaluated by this type of control in cycles every 30 seconds. Thus the command values change, if required, only at these times. The disadvantage of a continuously varying temperature as a result of this feedback control option is in contrast with the advantage of this very simple 2-point room temperature control. For this reason, quick-reaction heating or cooling systems should not be triggered by a 2-point feedback control system, for this can lead to very high overshooting of the temperature, thus resulting in loss of comfort. When presetting the hysteresis limiting values, you should distinguish between the operating modes.

"Heating" or "cooling" single operating modes:

In heating mode, the controller will turn on the heating when the room temperature has fallen below a preset limit. In heating mode, the feedback control will only turn off the heating once a preset temperature limit has been exceeded.

In cooling mode, the controller will turn on the cooling system when the room temperature has exceeded a preset limit. The control system will only turn off the cooling system once the temperature has fallen below a preset limit. In this connection, variable "1" or "0" will be output, depending on the switching status, if the temperature exceeds or falls below the hysteresis limits.

The hysteresis limits of both operating modes can be configured in the ETS.

- i** It has to be pointed out that the " +||| " or " -||| " icons will light up on the display or that the message objects for heating and cooling will already become active as soon as the temperature falls short of the temperature setpoint of the active operating mode in case of heating or exceeds the temperature setpoint in case of cooling. In this case the hysteresis is not being considered.

The following two images each show a 2-point feedback control for the individual operating modes "Heating" (Figure 29) or "Cooling" (Figure 30). The images take two temperature setpoints, one-stage heating or cooling and non-inverted command value output.

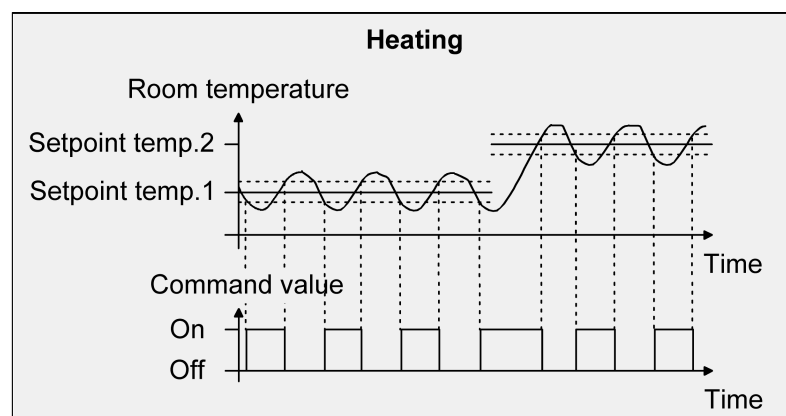

Figure 29: 2-point feedback control for the single "Heating" operating mode

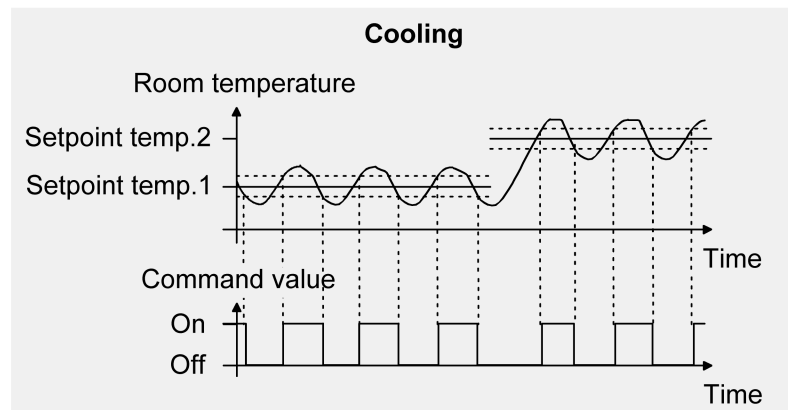

Figure 30: 2-point feedback control for the single "Cooling" operating mode

An additional 2-point feedback control heating or cooling level works exactly the same as the 2-point feedback control of the basic level. The difference is that the setpoint and the hysteresis values will shift by taking into account the configured level offset.

"Heating and cooling" mixed operating mode:

In mixed operation, a distinction is made whether the change-over between heating and cooling is to be effected automatically or in a controlled way through the object...

- With automatic operating mode change-over, in the heating mode the controller will turn on the heating when the room temperature has fallen below a preset hysteresis limit. In this case, as soon as the room temperature exceeds the setpoint of the current operating mode, the feedback control will turn off the heating in the heating mode. Similarly, in cooling mode, the controller will turn on the cooling system when the room temperature has exceeded a preset hysteresis limit. As soon as the room temperature falls below the setpoint of the current operating mode, the feedback control will turn off the cooling system in the cooling mode. Thus, in mixed operation, there is no upper hysteresis limit for heating or no lower one for cooling, respectively, for these values would be in the deadband. Within the deadband, neither heating nor cooling will take place.
- With operating mode change-over via the object, in the heating mode, the controller will turn on the heating when the room temperature has fallen below a preset hysteresis limit. The feedback control will only turn off the heating in the heating mode once the preset upper hysteresis limit has been exceeded. In the same way, in cooling mode, the controller will turn on the cooling system when the room temperature has exceeded a preset hysteresis limit. The feedback control will only turn off the cooling system in the cooling mode once the temperature has fallen below the preset lower hysteresis limit. As with the individual modes of heating or cooling, there are two hysteresis limits per operating mode. Although there is a deadband for the calculation of the temperature setpoints for cooling, it has no influence of the calculation of the two-point control value, as the operating mode is switched over "manually" through the corresponding object. Within the hysteresis spans, it thus will be possible to request heating or cooling energy for temperature values that are located within the deadband.

i Also with an automatic operating mode switch, an upper hysteresis limit for heating and a lower hysteresis limit for cooling can be configured in the ETS for 2-point feedback control, although they have no function.

The following two images show 2-point feedback control for the mixed operating mode "Heating and cooling", distinguishing between heating mode (Figure 31) and cooling mode (Figure 32). The images take two temperature setpoints, a non-inverted command value output and an automatic operating mode change-over. When the operating mode is changed-over via the object, an upper hysteresis for heating and a lower hysteresis for cooling and be configured.

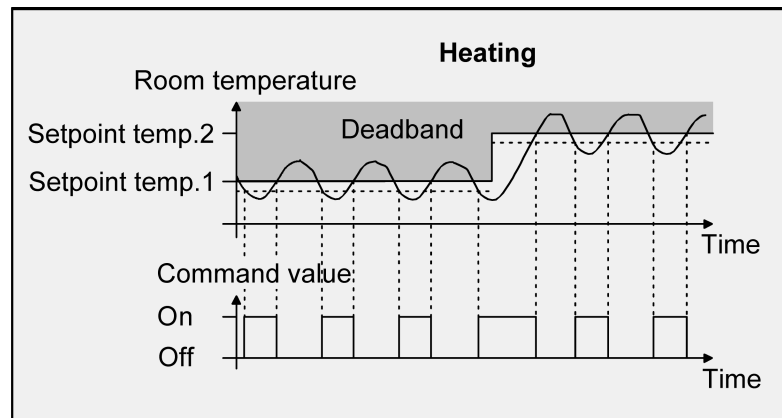

Figure 31: 2-point feedback control for mixed "Heating and cooling" mode with active heating mode.

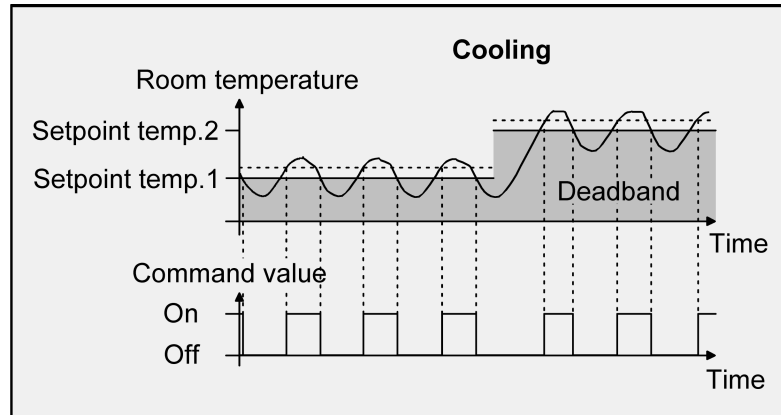

Figure 32: 2-point feedback control for mixed "Heating and cooling" mode with active cooling operation.

Depending on the switching state, the command value "1" or "0" will be output if the values exceed or remain under the hysteresis limits or the setpoints.

- i** It has to be pointed out that the " +||| " or " -||| " icons will light up on the display or that the message objects for heating and cooling will already become active as soon as the temperature falls short of the temperature setpoint of the active operating mode in case of heating or exceeds the temperature setpoint in case of cooling. In this case the hysteresis is not being considered.

An additional 2-point feedback control heating or cooling level works exactly the same as the 2-point feedback control of the basic level. The difference is that the setpoint and the hysteresis

values will shift by taking into account the configured level offset.

4.2.4.2.3 Adapting the control algorithms

Adapting the PI control

There are several systems available, which may heat or cool a room. One option is to uniformly heat or cool the surroundings via heat transfer media (preferably water or oil) in connection with room air convection. Such systems are used, for example, with wall mounted heaters, underfloor heating or cooling ceilings.

Alternatively or additionally forced air systems may heat or cool rooms. In most cases such systems are electrical forced hot air systems, forced cool air systems or refrigerating compressors with fan. Due to the direct heating of the room air such heating and cooling systems work quite swiftly.

The control parameters need to be adjusted so that the PI control algorithm may efficiently control all common heating and cooling systems thus making the room temperature control work as fast as possible and without deviation. Certain factors can be adjusted with a PI control that can influence the control behaviour quite significantly at times. For this reason, the room temperature controller can be set to predefined 'experience values' for the most common heating and cooling systems. In case the selection of a corresponding heating or cooling system does not yield a satisfactory result with the default values, the adaptation can optionally be optimized via control parameters.

Predefined control parameters for the heating or cooling stage and, if applicable, also for the additional stages are adjusted via the "type of heating" or "type of cooling" parameters. These fixed values correspond to the practical values of a properly planned and executed air conditioning system and will result in an ideal behaviour of the temperature control. The heating and cooling types shown in the following tables can be specified for heating and cooling operation.

Type of heating	Proportional range (preset)	Reset time (preset)	Recommended PI control type	Recommended PWM cycle time
Heat water heating	5 Kelvin	150 minutes	Continuous / PWM	15 min.
Underfloor heating	5 Kelvin	240 minutes	PWM	15-20 min.
Electrical heating	4 Kelvin	100 minutes	PWM	10-15 min.
Fan coil unit	4 Kelvin	90 minutes	Continuous	---
Split unit (split climate control unit)	4 Kelvin	90 minutes	PWM	10-15 min.

Table 3: Predefined control parameters and recommend control types for heating systems

Cooling type	Proportional range (preset)	Reset time (preset)	Recommended PI control type	Recommended PWM cycle time
Cooling ceiling	5 Kelvin	240 minutes	PWM	15-20 min.
Fan coil unit	4 Kelvin	90 minutes	Continuous	---
Split unit (split climate control unit)	4 Kelvin	90 minutes	PWM	10-15 min.

Table 4: Predefined control parameters and recommend control types for cooling systems

If the "Type of heating" or "Type of cooling" parameters are set to "Via control parameters" it will be possible to adjust the control parameter manually. The feedback control may be considerably influenced by presetting the proportional range for heating or for cooling (P component) and the reset time for heating or for cooling (I component).

- i** Even small adjustments of the control parameters will lead to noticeable different control behaviour.
- i** The adaptation should start with the control parameter setting for the corresponding heating or cooling system according to the fixed values mentioned in Tables 3 & 4.

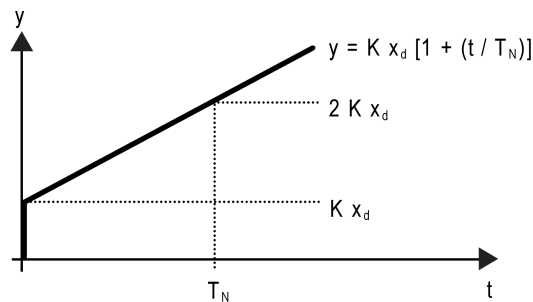

Figure 33: Function of the command value of a PI control

y: Command value
 x_d : Control difference ($x_d = x_{set} - x_{act}$)
 $P = 1/K$: Configurable proportional band
 $K = 1/P$: Gain factor
 T_N : Configurable reset time

PI control algorithm: Command value $y = K x_d [1 + (t / T_N)]$

Deactivation of the reset time (setting = "0") ->
 P control algorithm: Command value $y = K x_d$

Parameter setting	Effect
P: Small proportional range	Large overshoot in case of setpoint changes (possibly permanently), quick adjustment to the setpoint
P: Large proportional range	no (or small) overshooting but slow adjustment
T_N : Short reset time	Fast compensation of control deviations (ambient conditions), risk of permanent oscillations
T_N : Long reset time	Slow compensation of control deviations

Table 5: Effects of the settings for the control parameters

Adapting the 2-point feedback control

The 2-point control represents a very simple temperature control. For this type of feedback control, two hysteresis temperature values are set. The upper and lower temperature hysteresis limits can be adjusted via parameters. It has to be considered that...

- A small hysteresis will lead to small temperature variations but to a higher bus load.
- A large hysteresis switches less frequently but will cause uncomfortable temperature variations.

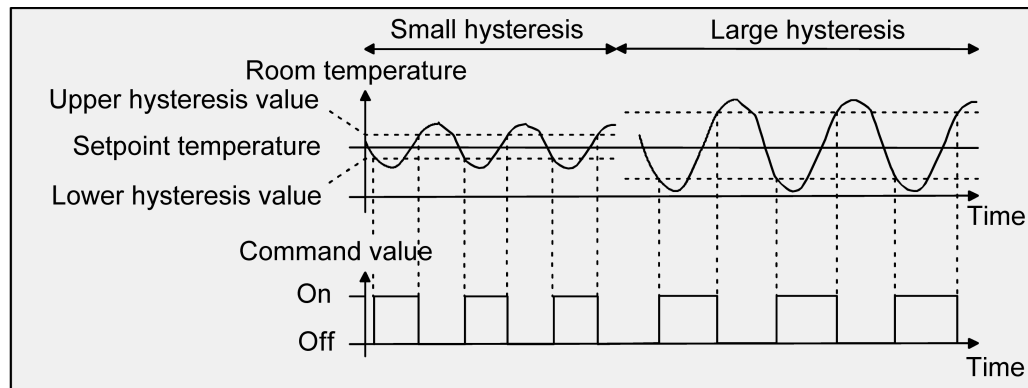



Figure 34: Effects of the hysteresis on the switching behaviour of the command value of 2-point feedback control

4.2.4.2.4 Operating mode switchover

Introduction - The operating modes





The room temperature controller has various operating modes. The selection of these modes will, for example, facilitate the activation of different temperature setpoints, depending on the presence of a person, on the state of the heating or cooling system, on the time of the day, or on the day of the week. The following operating modes can be distinguished...

- Comfort mode
Comfort mode is usually activated if persons are in a room, and the room temperature should, for this reason, be adjusted to an adequately convenient value. The change-over to this operating mode can take place either by pressing a button or with presence control, for example, using a PIR motion detector on the wall or a ceiling mounted detector. The activated Comfort mode will be indicated on the display by the  icon.

 - Standby mode
If a room is not used during the day because persons are absent, you can activate the Standby mode. Thereby, you can adjust the room temperature on a standby value, thus to save heating or cooling energy, respectively. The activated standby mode will be indicated on the display by the  icon.

 - Night operation
During the night hours or during the absence of persons for a longer time, it mostly makes sense to adjust the room temperature to lower values for heating systems (e.g. in bedrooms). In this case, cooling system can be set to higher temperature values, if air conditioning is not required (e.g. in offices). For this purpose, you can activate the Night mode. The activated Night mode will be indicated on the display by the  icon.

 - Frost/heat protection mode
Frost protection will be required if, for example, the room temperature must not fall below critical values while the window is open. Heat protection can be required where the temperature rises too much in an environment which is always warm, mainly due to external influences. In such cases, you can activate the Frost/heat protection operating mode and prescribe some temperature setpoint of its own for either option, depending on whether "Heating" or "Cooling" has been selected, to prevent freezing or overheating of the room. The activated Frost/heat protection mode will be indicated on the display by the  icon.

 - Comfort extension (temporary Comfort mode)
You can activate the comfort extension from the night or frost/heat protection mode (not triggered by the "Window status" object) and use it to adjust the room temperature to a comfort value for some time if, for example, the room is also 'used' during the night hours. This mode can exclusively be activated by a presence button or also by the presence object, respectively. The comfort extension option will be automatically deactivated after a definable time has elapsed, or by pressing the presence button once more, or by receiving a presence object value = 0, respectively. You cannot retrigger this extension. The activated comfort extension option will be indicated on the display by the combination of the   or   icons.
- i** You can assign an own temperature setpoint to the "Heating" or "Cooling" operating modes for each operating mode.

Operating mode switchover

You can activate or switch over the operating modes in various ways. Depending on one another in priority, activation or change-over is possible by...

- Local operation on the push button sensor using the display buttons (if enabled),
- Local control on the pushbutton sensor using push-button function (controller operating mode) and configured operating mode change-over,
- The KNX/EIB communication objects separately available for each operating mode or alternatively through the KONNEX objects. In the last case, also through a controller extension.

The following section describes the individual options for changing over the operating modes in more detail.

Switching over the operating mode using display buttons

The display buttons can be used to activate the second operating level. At this point, it is possible to activate the "Comfort", "Standby", "Night" or "Frost/heat protection (absence)" operating modes from the "Operating mode switchover" menu.

In the second operating level, it is not possible to switch over to the comfort extension.

- i** The presence signal, the window status and the forced object for operating mode switchover (see following sections) have a higher priority than the switchover via the second operating level. Therefore, change-overs by evaluating the appropriate objects have priority.

Change-over of the operating mode using push button function

As soon as a button of the pushbutton sensor is configured to "Controller operating mode", the "Operating mode change-over" function can be configured in the button parameters. In this case, a further definition is required in the ETS configuration as to which operating mode is activated when a button is pressed. The "Comfort", "Standby", "Night" and "Frost/heat protection" modes are available for this purpose.

To be able to activate the comfort extension, it is possible to use a presence button either optionally or in addition. The presence button, just as with the operating mode change-over, is a push-button function of the pushbutton sensor for the controller operating mode. The presence button means it is possible to change to the comfort extension or to deactivate it prematurely when Night or Frost/heat protection mode (not activated by the "Window status" object) has been activated. Also, it is possible to change over from the Standby to the Comfort mode when the presence button is pressed.

The function of the status LED of a button can always be configured, irrespective of the button function. For example, it is possible that the controller status LED displays the operating mode of the controller or is controlled by a separate communication object. With the "Presence button" button function, the "Active operating mode display" and "Inactive operating mode display" settings can be selected, using which the status LED immediately displays the presence status of the controller.

Change-over of the operating mode using KNX/EIB communication objects

A distinction is made whether the operating modes should be changed over via separate 1-bit objects or, alternatively, by the 1-byte KONNEX objects.

The "Operating mode change-over" parameter in the "Room temperature control -> Controller general" parameter branch specifies the switching method as follows...

- Operating mode change-over "Via switching (4 x 1 bit)"

There is a separate 1-bit change-over object for each operating mode. Each of these objects allows the current operating mode to be switched over or to be set, depending on the priority. Taking account of the priority, a specific hierarchy will result from the operating mode change-over by the objects, a distinction being made between presence detection by the presence button or the motion detector. In addition, the status of the window in the room can be evaluated using the "Window status" object, meaning that, when the window is open, the controller can switch to Frost/heat protection mode, irrespective of the set operating mode, in order to save energy.

Table 6 also shows the status of the communication objects and the resulting operating mode.

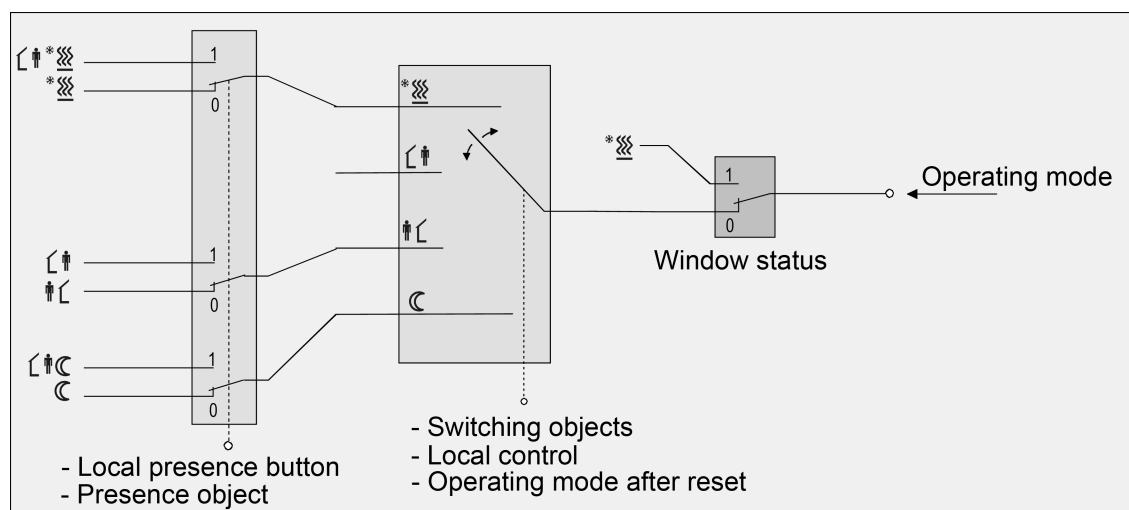

Figure 35: Operating mode change-over through 4 x 1-bit objects with presence button

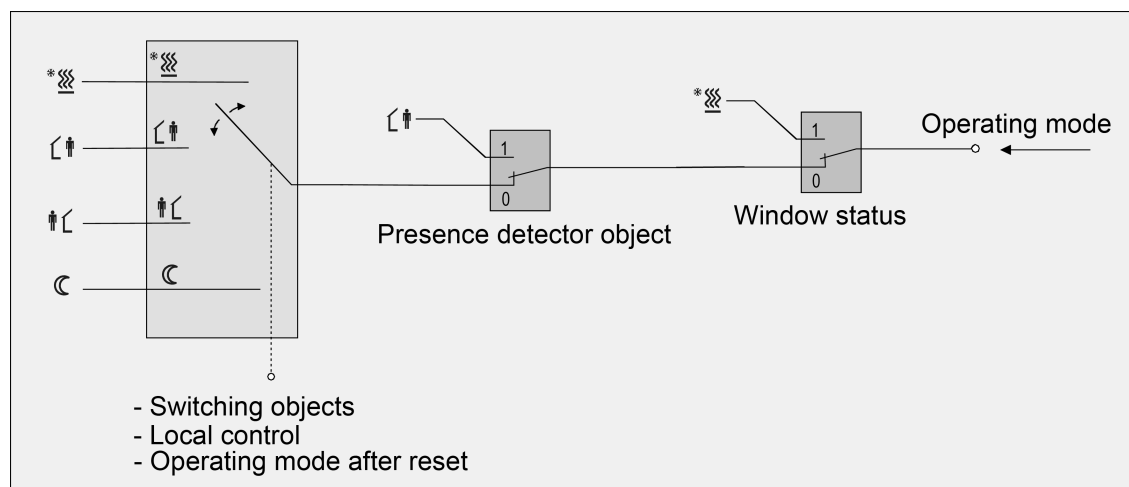

Figure 36: Operating mode change-over through 4 x 1-bit objects with motion detector

Object *☰	Object ┌┆	Object ┆┌	Object ☾	Object "Window status"	Motion button	Motion detector	Resulting operating mode
1	X	X	X	0	0	-	Frost/heat protection
0	1	X	X	0	0	-	Comfort mode
0	0	1	X	0	0	-	Standby mode
0	0	0	1	0	0	-	Night operation
0	0	0	0	0	0	-	As parameter *
X	X	X	X	1	X	-	Frost/heat protection
1	X	X	X	0	1	-	Comfort extension
0	1	X	X	0	1	-	Comfort mode
0	0	1	X	0	1	-	Comfort mode
0	0	0	1	0	1	-	Comfort extension
0	0	0	0	0	1	-	Comfort mode/ extension **
1	X	X	X	0	-	0	Frost/heat protection
0	1	X	X	0	-	0	Comfort mode
0	0	1	X	0	-	0	Standby mode
0	0	0	1	0	-	0	Night operation
0	0	0	0	0	-	0	As parameter *
X	X	X	X	1	-	X	Frost/heat protection
X	X	X	X	0	-	1	Comfort mode

Table 6: Status of the communication objects and the resulting operating mode

X: Status irrelevant

-: Not possible

*: Operating mode as parameter "Operating mode, when all bit objects = 0 (preferential position)".

**.: Dependent on the last active operating mode.

i When switching over an operating mode, for example through local operation, the objects "Comfort mode", "Standby mode", "Night mode" and "Frost/heat protection" are updated by the controller and can be read out when the appropriate Read flags are set. If the "Transmit" flag has been set for these objects the current values will, in addition, be automatically transmitted to the bus when they are changed. After bus voltage recovery or after initialisation of the controller, the object which corresponds to the selected operating mode will be updated and its value actively transmitted to the bus if the "Transmit" flag has been set.

i A change-over through the objects has the same importance as a local change-over on the pushbutton sensor (second operating level, button as controller operation). An operating mode set by an object can therefore be shifted by an operating mode change-over on the device, if no higher-priority mode (e.g. window contact / motion detector) is activated.

i In parameterisation of a presence button: the presence object will be active ("1") for the period of an active comfort extension. The presence object will be automatically deleted ("0") if the comfort extension is stopped after the extension time has elapsed, or if the operating mode has been changed by a higher-priority operation through the change-over objects or by local control. The controller therefore automatically resets the status of the presence button when an object is received via the operating mode objects.

- Operating mode change-over through "value" (2 x 1 byte):

There is a common 1-byte change-over object for all operating modes. During the running time, the operating mode can be changed over through this value object immediately after the receipt of only one telegram. In this connection, the value received will set the operating mode. In addition, a second 1-byte object is available which, by forced control and through higher level, can set an operating mode, irrespective of any other change-over options. According to the KONNEX specification, both 1-byte objects have been implemented. Taking account of the priority, a specific hierarchy will result from the operating mode change-over by the objects, a distinction being made between presence detection by the presence button or the motion detector. In addition, the status of the window in the room can be evaluated using the "Window status" object, meaning that, when the window is open, the controller can switch to Frost/heat protection mode, irrespective of the set operating mode, in order to save energy. Table 7 also shows the status of the communication objects and the resulting operating mode.

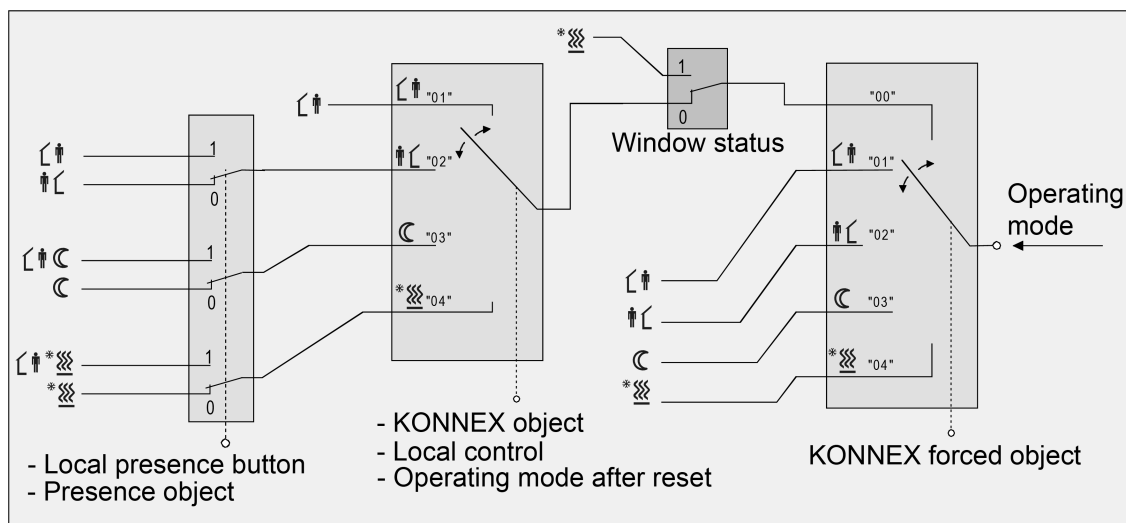

Figure 37: Operating mode change-over through KONNEX object with presence button

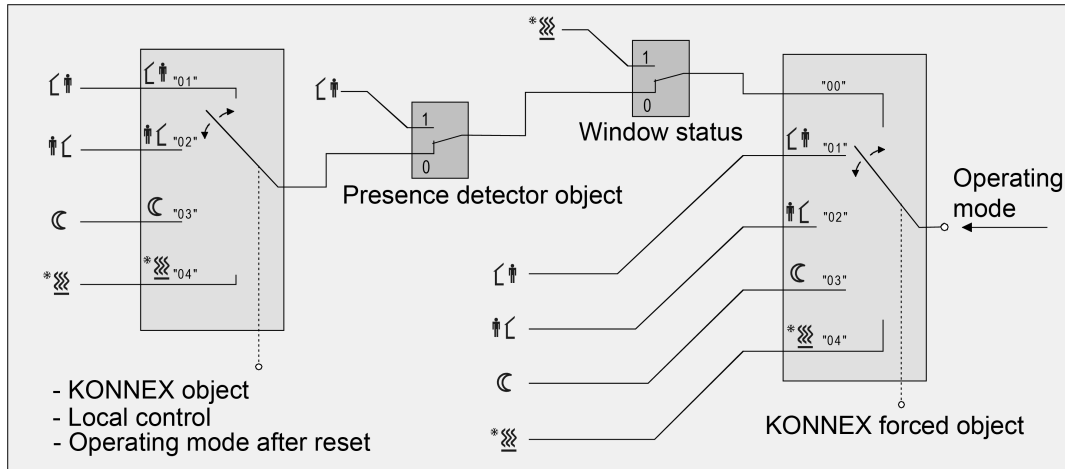

Figure 38: Operating mode change-over through KONNEX object with motion detector

Object value "Operating mode change-over"	Object value "Forced object operating mode"	Object "Window status"	Motion button	Motion detector	Resulting operating mode
00	00	0	X	0	Undefined status, no modification
01	00	0	0	-	Comfort mode
02	00	0	0	-	Standby mode
03	00	0	0	-	Night operation
04	00	0	0	-	Frost/heat protection
01	00	0	1	-	Comfort mode
02	00	0	1	-	Comfort mode
03	00	0	1	-	Comfort extension
04	00	0	1	-	Comfort extension
01	00	0	-	0	Comfort mode
02	00	0	-	0	Standby mode
03	00	0	-	0	Night operation
04	00	0	-	0	Frost/heat protection
X	00	0	-	1	Comfort mode
X	00	1	-	X	Frost/heat protection

X	00	1	X	-	Frost/heat protection
X	01	X	X	X	Comfort mode
X	02	X	X	X	Standby mode
X	03	X	X	X	Night operation
X	04	X	X	X	Frost/heat protection

Table 7: Status of the communication objects and the resulting operating mode

X: Status irrelevant

-: Not possible

- i** When changing over an operating mode, for example through local control, the KONNEX switching object is updated by the controller and can be read out when the "Read" flag is set. If the "Transmit" flag has been set for this object the current value will, in addition, be automatically transmitted to the bus when it is changed.
After bus voltage recovery or after initialisation of the controller, the value corresponding to the set operating mode will be actively transmitted to the bus if the "Transmit" flag has been set. The "Transmit" flag must always be set when using controller extensions.
- i** Change-over by the KONNEX object "Operating mode change-over" has the same priority as a local change-over on the pushbutton sensor. An operating mode set by the object (e.g. by a controller extension) can therefore be shifted by an operating mode change-over on the device, if no higher-priority mode (e.g. window contact / motion detector) or the KONNEX forced object is activated.
The KONNEX override object will always have the highest priority.
- i** In parameterisation of a presence button: the presence object will be active ("1") for the period of an active comfort extension. The presence object will be automatically deleted ("0") if the comfort extension is stopped after the extension time has elapsed, or if the operating mode has been changed by a higher-priority operation through the change-over objects or by local control or a forced operating mode is deactivated by the KONNEX forced object (forced object -> "00"). The controller therefore automatically resets the status of the presence button when an object value is received via the operating mode objects or the forced object is reset.

Additional information on the Presence function / Comfort extension

With presence detection, the room temperature controller can quickly change over to a comfort extension upon push button actuation or go into the Comfort mode when movement by a person in the room is detected. In this connection, the "Presence detection" parameter in the "Room temperature control -> Controller functionality" parameter node sets whether presence detection should be movement-controlled by a motion detector or manual through presence button actuation...

- Presence detection by the presence button
If the presence button is configured for presence detection, you can select the "Presence button" setting in the "Controller operating mode" pushbutton sensor push-button functions. In addition, the "Presence object" is enabled. In this way, you can actuate the presence button or use a presence object value = "1" to change over to comfort extension when the Night or the Frost/heat protection mode is active (not activated by the "window status" object). The extension will be automatically deactivated as soon as the configured "Length of comfort extension" time has elapsed. If you press the presence button once more, or if the presence object receives a value = "0", you can deactivate the comfort extension earlier. You cannot re-trigger such extension time.
If you have set the length of comfort extension to "0" in the ETS, you cannot activate a comfort extension from the night or frost/heat protection mode. In this case, the operating mode will not be changed, although the presence function has been activated.
If the standby mode is active you can operate the presence button or use a presence object value = "1" to change over to the comfort mode. This will also be the case if you have configured the length of comfort prolongation to "0". The comfort mode will remain active as long as the presence function remains active, or until another operating mode comes into effect.
The presence object or the presence function, respectively, will always be deleted whenever a switch-over to a different operating mode takes place, or after a forced mode has been deactivated (associated with KONNEX forced switch-over). A presence function activated before a device reset (programming operation, bus voltage failure) is always deleted, along with the object value, after the reset.

 - Presence detection by the motion detector
If a motion detector is configured for motion detection, then the controller only evaluates the "Presence object". With this object, it is possible to integrate motion detectors into room temperature control. If a movement is detected ("1" telegram) the controller will change over into the Comfort mode. In this connection, it is irrelevant what has been set by the change-over objects or by local control directly on the device. Only a window contact or the KONNEX forced object are of higher priority.
After the movement delay time has elapsed in the motion detector ("0" telegram), the controller will return to the operating mode which was active before presence detection, or it will compensate the telegrams of the operating mode objects received during presence detection, respectively. During active presence detection, you cannot change-over the operating mode on the room temperature controller.
A presence function activated before a device reset (programming operation, bus voltage failure) is always deleted, along with the object value, after the reset. In this case, the motion detector must transmit a new "1" telegram to the controller to activate the presence function.
- i** If the motion detector is configured for presence detection, it is always possible to configure the presence button in the "Controller operating mode" pushbutton sensor push-button functions. However, this parameterisation then has no effect.

Additional information on the window status

The room temperature controller offers various options to change over into the Frost/heat protection mode. In addition to the change-over by the corresponding operating mode change-over object, a window contact can activate frost/heat protection. With these options, the window contact has higher priority.

A telegram having the value of = "1" (open window) sent to the "Window status" object will activate the frost/heat protection mode. If this is the case, this operating mode cannot be overridden by the operating mode change-over objects (with the exception of the KONNEX override object).

Only a telegram with the value of = "0" (closed window) will reset the window status and deactivate the frost/heat protection mode, if it wasn't set in another way. The operating mode set before the opening of the window or that mode carried by the bus while the window was open is then activated.

Additional information on the operating mode after a reset

In the ETS, it is possible to use the "Operating mode after reset" parameter in the "Room temperature control -> Controller general" parameter node to set which operating mode should be activated after bus voltage recovery or re-programming by the ETS. The following settings are possible...

- "Comfort operation" -> The comfort mode will be activated after the initialisation phase.
- "Standby mode" -> The standby mode will be activated after the initialisation phase.
- "Night operation" -> The night mode will be activated after the initialisation phase.
- "Frost/heat protection operation" -> The frost/heat protection mode will be activated after the initialisation phase.

The objects associated with the activated operating mode will be updated after a reset.

4.2.4.2.5 Temperature setpoints

Overview of the setpoint temperatures

Depending on the operating mode, different cases should be distinguished when specifying the setpoint temperature, which then have an impact on the setpoint specifications and the dependencies of the setpoint temperatures.

Setpoints for operating mode "Heating"

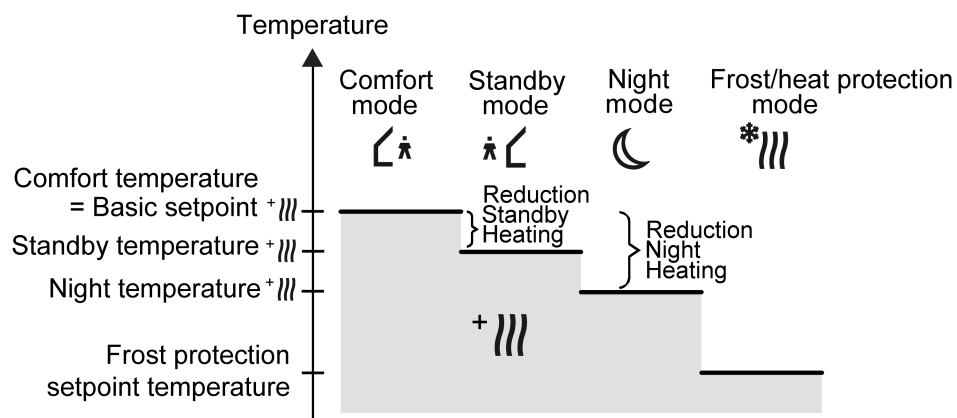

Figure 39: Setpoint temperatures in the operating mode "Heating" (recommended specification)

In this operating mode, the setpoint temperatures for Comfort, Standby and Night mode and the frost protection temperature can be preset (Figure 39).

The following applies...

$$T_{\text{Standby setpoint heating}} \leq T_{\text{Comfort setpoint heating}}$$

or

$$T_{\text{Night setpoint heating}} \leq T_{\text{Comfort setpoint heating}}$$

The standby and night setpoint temperatures are derived from the reduction temperatures configured in the ETS from the comfort setpoint temperature (basic setpoint). It is also possible to adjust other decrease temperatures directly via local control in the second operating level on the controller, if enabled in the ETS, by changing the setpoint temperature values for Night and Standby mode.

The frost protection is supposed to prevent the heating system from freezing. For this reason the frost protection temperature should be set to a smaller value than the night temperature for heating (default: +7 °C). In principle, however, it is possible to select frost protection temperature values between +7 °C and +40 °C.

The possible range of values for a set-temperature lies between + 7.0 °C and + 99.9 °C for "heating" and is bounded by the frost protection temperature in the lower range.

The level offset configured in ETS will be additionally considered in a two-level heating mode (Figure 40).

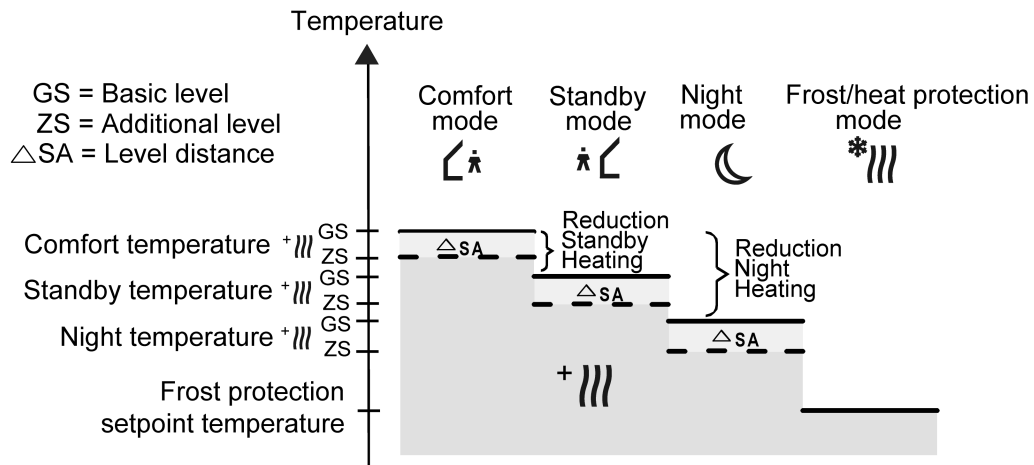

Figure 40: Setpoint temperatures in the operating mode "Basic and additional heating" (recommended specification)

$$T_{\text{Comfort setpoint additional level heating}} \leq T_{\text{Comfort setpoint basic level heating}}$$

$$T_{\text{Standby setpoint additional level heating}} \leq T_{\text{Standby setpoint basic level heating}}$$

$$T_{\text{Standby setpoint heating}} \leq T_{\text{Comfort setpoint heating}}$$

or

$$T_{\text{Comfort setpoint additional level heating}} \leq T_{\text{Comfort setpoint basic level heating}}$$

$$T_{\text{Night setpoint additional level heating}} \leq T_{\text{Night setpoint basic level heating}}$$

$$T_{\text{Night setpoint heating}} \leq T_{\text{Comfort setpoint heating}}$$

Setpoints for the "cooling" operating mode

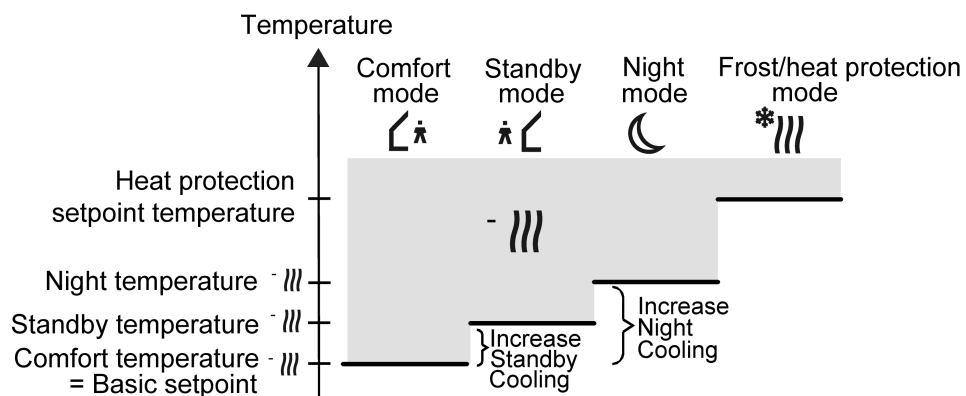

Figure 41: Setpoint temperatures in the operating mode "Cooling" (recommended specification)

The setpoint temperatures for Comfort, Standby and Night mode exist in this operating mode and the heat protection temperature can be preset (Figure 41).
The following applies...

$$T_{\text{Comfort setpoint cooling}} \leq T_{\text{Standby setpoint cooling}}$$

or

$$T_{\text{Comfort setpoint cooling}} \leq T_{\text{Night setpoint cooling}}$$

The standby and night set-temperatures are derived after the configured increase temperatures from the comfort set-temperature (basic setpoint).

The heat protection is supposed to ensure that the temperature does not exceed the maximum permissible room temperature in order to protect system components. For this reason, the heat protection temperature should be set to a larger value than the night temperature (default: +35 °C). In principle, however, it is possible to select heat protection temperature values between +7 °C and +45 °C.

The possible range of values for a set-temperature lies between - 99.9 °C and + 45.0 °C for "cooling" and is bounded by the heat protection temperature in the upper range.

The level offset configured in ETS will be additionally considered in a two-level cooling mode (Figure 42).

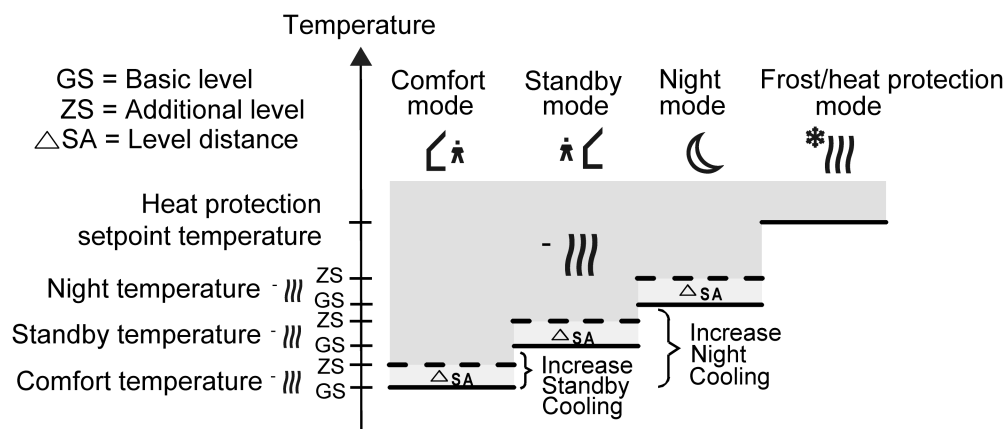

Figure 42: Setpoint temperatures in the operating mode "Basic and additional cooling" (recommended specification)

$$T_{\text{Comfort setpoint basic level heating}} \leq T_{\text{Comfort setpoint additional level heating}}$$

$$T_{\text{Standby setpoint basic level heating}} \leq T_{\text{Standby setpoint additional level heating}}$$

$$T_{\text{Comfort setpoint cooling}} \leq T_{\text{Standby setpoint cooling}}$$

or

$$T_{\text{Comfort setpoint basic level heating}} \leq T_{\text{Comfort setpoint additional level heating}}$$

$$T_{\text{Night setpoint basic level heating}} \leq T_{\text{Night setpoint additional level heating}}$$

$$T_{\text{Comfort setpoint cooling}} \leq T_{\text{Night setpoint cooling}}$$

Setpoints for the "heating and cooling" operating mode

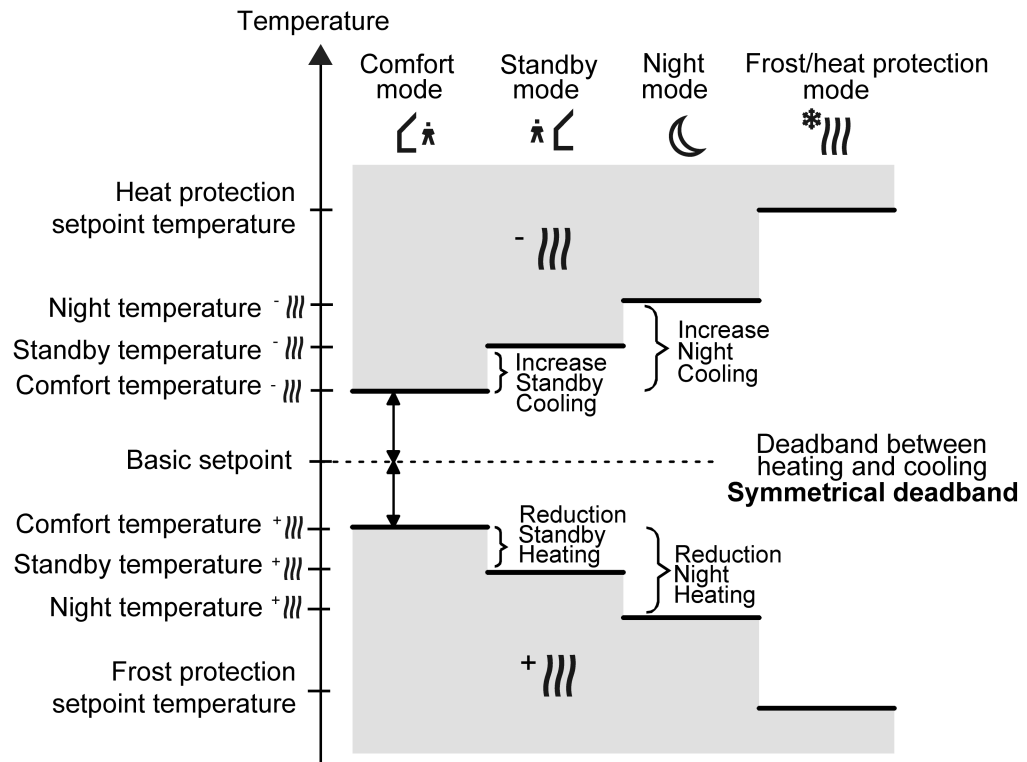

Figure 43: Setpoint temperatures in the operating mode "Heating and cooling" with symmetrical deadband (recommended specification)

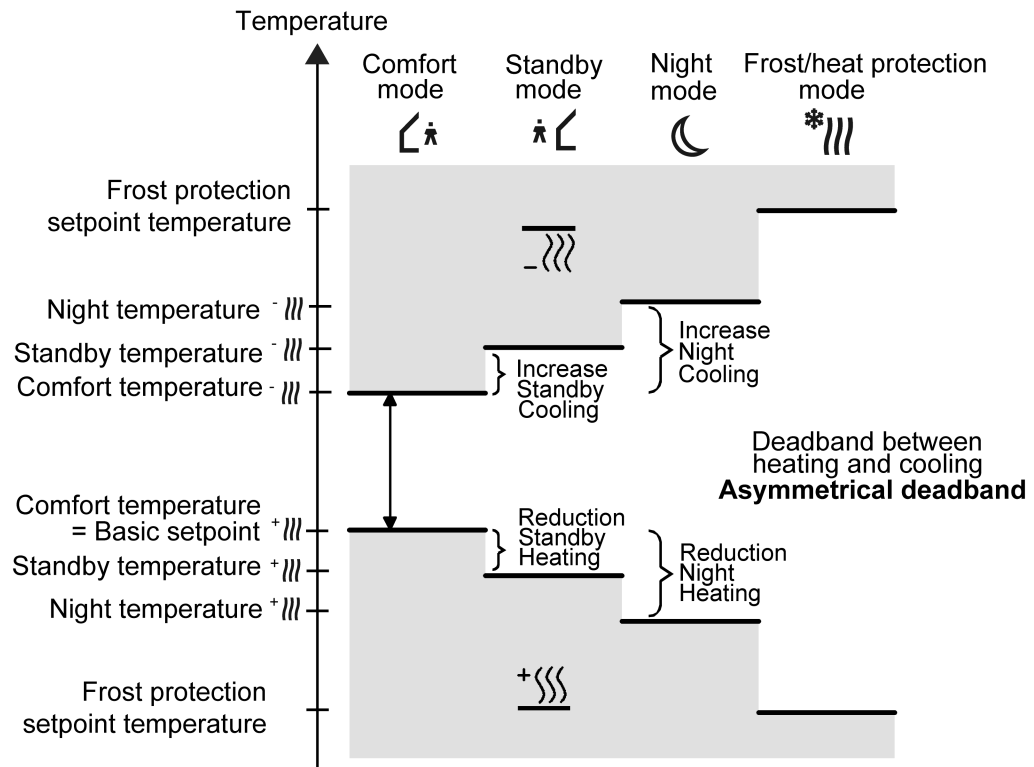

Figure 44: Setpoint temperatures in the operating mode "Heating and cooling" with asymmetrical deadband (recommended specification)

For this heating/cooling operating mode, the setpoint temperatures of both heating/cooling modes exist for the Comfort, Standby and Night operating modes as well as the deadband. A distinction is made in the deadband position with combined heating and cooling. A symmetrical (Figure 43) or an asymmetrical (Figure 44) deadband position can be configured. In addition, the frost protection and the heat protection temperatures can be preset. The following applies...

$$T_{\text{Standby setpoint heating}} \leq T_{\text{Comfort setpoint heating}} \leq T_{\text{Comfort setpoint cooling}} \leq T_{\text{Standby setpoint cooling}}$$

or

$$T_{\text{Night setpoint heating}} \leq T_{\text{Comfort setpoint heating}} \leq T_{\text{Comfort setpoint cooling}} \leq T_{\text{Night setpoint cooling}}$$

The set-temperatures for "Standby" and "Night" are derived from the comfort setpoint temperatures for heating or cooling. The temperature increase (for cooling) and the temperature decrease (for heating) of both operating modes can be preset in ETS. The comfort temperatures itself are derived from the deadband and the basic setpoint.

The frost protection is supposed to prevent the heating system from freezing. For this reason the frost protection temperature should be set to a smaller value than the night temperature for heating (default: +7 °C). In principle, however, it is possible to select frost protection temperature values between +7 °C and +40 °C. The heat protection is supposed to prevent the temperature from exceeding the maximum permissible room temperature in order to protect system components. For this reason the heat protection temperature should be set to a larger value than the night temperature for cooling (default: +35 °C). In principle, however, it is possible to select heat protection temperature values between +7 °C and +45 °C.

The possible range of values for a set-temperature ("heating and cooling") lies between + 7 °C and + 45.0 °C and is bounded by the frost protection temperature in the lower range and by the heat protection temperature in the upper range.

The level offset configured in ETS will be additionally considered in a two-level heating or cooling mode (Figure 45).

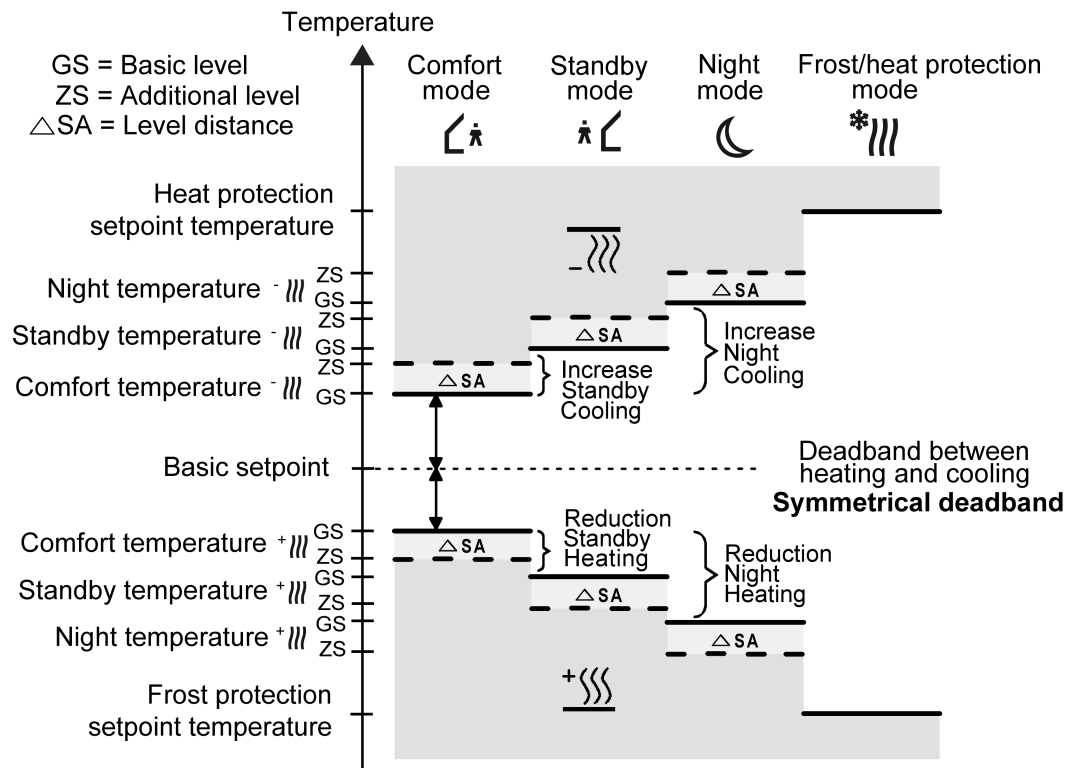

Figure 45: Setpoint temperatures in the operating mode "Basic and additional heating and cooling" with symmetrical deadband (recommended specification)

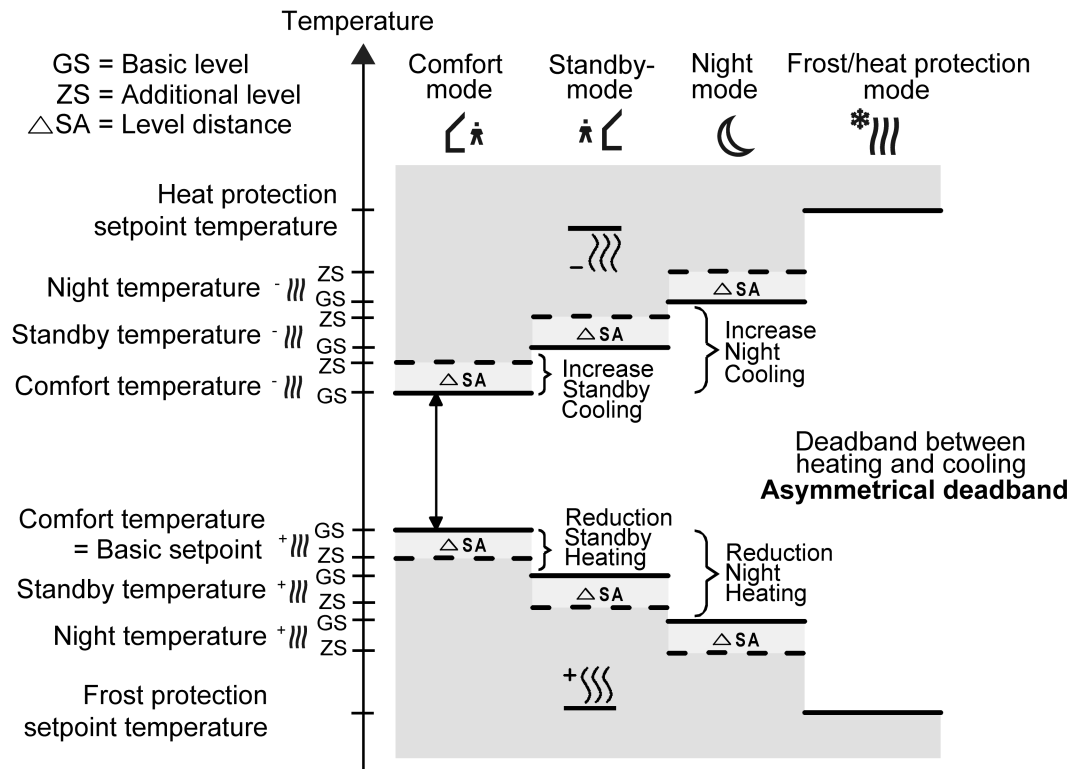

Figure 46: Setpoint temperatures in the operating mode "Basic and additional heating and cooling" with asymmetrical deadband (recommended specification)

$$T_{\text{Comfort setpoint add. level Heating}} \leq T_{\text{Comfort setpoint basic level Heating}} \leq T_{\text{Comfort setpoint basic level Cooling}} \leq T_{\text{Comfort setpoint add. level Cooling}}$$

$$T_{\text{Standby setpoint add. level Heating}} \leq T_{\text{Standby setpoint basic level Heating}} \leq T_{\text{Standby setpoint basic level Cooling}} \leq T_{\text{Standby setpoint add. level Cooling}}$$

$$T_{\text{Standby setpoint heating}} \leq T_{\text{Comfort setpoint heating}} \leq T_{\text{Comfort setpoint cooling}} \leq T_{\text{Standby setpoint cooling}}$$

or

$$T_{\text{Comfort setpoint add. level Heating}} \leq T_{\text{Comfort setpoint basic level Heating}} \leq T_{\text{Comfort setpoint basic level Cooling}} \leq T_{\text{Comfort setpoint add. level Cooling}}$$

$$T_{\text{Night setpoint add. level Heating}} \leq T_{\text{Night setpoint basic level Heating}} \leq T_{\text{Night setpoint basic level Cooling}} \leq T_{\text{Night setpoint add. level Cooling}}$$

$$T_{\text{Night setpoint heating}} \leq T_{\text{Comfort setpoint heating}} \leq T_{\text{Comfort setpoint cooling}} \leq T_{\text{Night setpoint cooling}}$$

deadband and deadband positions in the combined heating and cooling operating mode

The comfort setpoint temperatures for heating and cooling are derived from the basic setpoint in consideration of the adjusted deadband. The deadband (temperature zone for which there is neither heating nor cooling) is the difference between the comfort setpoint temperatures.

The "deadband between heating and cooling", "deadband position" parameters as well as the "Basic temperature after reset" parameter are preset in the ETS configuration. One distinguishes between the following settings...

- deadband = "symmetrical"

The deadband preset in the ETS is divided into two parts at the basic setpoint. The comfort set-temperatures are derived directly from the basic setpoint resulting from the half Dead band.

The following applies...

$$T_{\text{Basic setpoint}} - \frac{1}{2}T_{\text{deadband}} = T_{\text{Comfort heating setpoint}}$$

and

$$T_{\text{Basic setpoint}} + \frac{1}{2}T_{\text{deadband}} = T_{\text{Comfort setpoint cooling}}$$

$$\rightarrow T_{\text{Comfort cooling setpoint}} - T_{\text{Comfort heating setpoint}} = T_{\text{deadband}}$$

$$\rightarrow T_{\text{Comfort cooling setpoint}} \geq T_{\text{Comfort heating setpoint}}$$

- deadband position = "Asymmetrical"

With this setting the comfort setpoint temperature for heating equals the basic setpoint. The deadband preset in the ETS is effective only from the basic setpoint in the direction of comfort temperature for cooling. Thus the comfort set-temperature for cooling is derived directly from the comfort setpoint for heating.

The following applies...

$$T_{\text{Basic setpoint}} = T_{\text{Comfort heating setpoint}}$$

$$\rightarrow T_{\text{Basic setpoint}} + T_{\text{deadband}} = T_{\text{Comfort heating setpoint}}$$

$$\rightarrow T_{\text{Comfort cooling setpoint}} - T_{\text{Comfort heating setpoint}} = T_{\text{deadband}}$$

$$\rightarrow T_{\text{Comfort cooling setpoint}} \geq T_{\text{Comfort heating setpoint}}$$

Setpoint presettings in the ETS

Temperature setpoints can be preset for each operating mode in the ETS as part of first configuration. It is possible to configure the setpoints for the "Comfort", "Standby" and "Night" modes in the ETS plug-in. If desired, the setpoint temperatures can be subsequently adjusted via local control during operation or controlled by KNX/EIB communication objects.

The "Frost/heat protection" operating mode allows the separate configuration of two temperature setpoints for heating (frost protection) and cooling (heat protection) solely in the ETS. These temperature values cannot be changed later during controller operation.

When presetting the setpoint temperatures for comfort, standby and night mode, attention has to be paid to the fact that all setpoints depend on each other as all values are derived from the basic temperature (basic setpoint) (see page 117). The "Basic temperature after reset" parameter in the "Setpoint" parameter page determines the basic setpoint, which is loaded when the device is programmed via the ETS. Taking into account the "Reduce / increase the setpoint temperature in standby mode" or "Reduce / increase the setpoint temperature in night mode" parameters the temperature setpoints for the standby and night mode are derived from this value depending on the heating or cooling operating mode. The deadband will be additionally considered for the "Heating and cooling" operating mode.

In two-level control mode, all set-temperatures of the additional level are derived from the setpoint temperatures of the basic level. The setpoint temperatures of the additional level are determined by subtracting the "Difference between basic and additional levels", which is permanently configured in the ETS, from the setpoints of the basic level in heating mode or by adding the setpoints in cooling mode. If the temperature setpoints of the basic level are changed by setting a new basic setpoint, the setpoint temperatures of the additional level will be indirectly and automatically changed as well. Both stages will heat or cool with the same actuating variable at the same time when the setpoint difference is "0".

Limitation of the setpoint temperatures in cooling mode

In accordance with German statutory requirements, the temperature at the workplace should be a maximum of 26 °C, or at least 6 K below outdoor temperatures of 32 °C. Exceeding these limits is only permissible in exception circumstances. To meet these requirements, the room temperature controller offers a setpoint temperature limit, which is only effective in cooling mode. If necessary, the controller limits the setpoint temperature to specific values and prevents an adjustment beyond the limits.

The "Setpoint temperature limit in cooling mode" parameter in the "Room temperature control -> Controller general -> Setpoint values" parameter node activates the limit and its function. The following settings are possible...

- Setting "Only difference to outdoor temperature"

In this setting, the outdoor temperature is monitored and compared to the active setpoint temperature. The maximum temperature difference to the outdoor temperature can be specified in the range between 1 K and 15 K. The specification is made using the "Difference to outdoor temperature in cooling mode" parameter. The value can be set in step widths of 1 K.

If the outdoor temperature rises above 32 °C in the sense of the statutory requirements, then the controller activates the setpoint temperature limit. It then permanently monitors the outdoor temperature and raises the setpoint temperature so that it is beneath the outdoor temperature by the amount configured. Should the outdoor temperature continue to rise, the controller raises the setpoint temperature until the required difference to the outdoor temperature is achieved. It is then not possible to undershoot the raised setpoint, e.g. by changing the basic setpoint change.

The change to the setpoint temperature limit is temporary. It only applies for as long as the outdoor temperature exceeds 32 °C.

With the setpoint temperature limit, the configured temperature difference relates to the setpoint temperature of the Comfort mode for cooling. In other operating modes, the temperature distance to Comfort mode must be taken into account. Example...

In the ETS, the difference to the outdoor temperature is set as 6 K. The Standby setpoint temperature is configured to 2 K higher than the Comfort setpoint temperature. The result of this is that, for command value limiting, the setpoint temperature in Standby operating mode may only be a maximum of 4 K below the outdoor temperature. The setpoint temperature limit applies to Night mode in the same way.

- i The automatic setpoint temperature raising by the setpoint temperature limit goes only as far as the configured heat protection temperature. Therefore the heat protection temperature can never be exceeded.
- i A basic setpoint shift never affects an active setpoint temperature limit with differential measurement to the outdoor temperature. In this case, the setpoint temperature limit only works with the unshifted basic setpoint. A setpoint shift active before the limitation is restored after the limitation, if it was not reset in another way, e.g. by an operating mode change-over.

- Setting "Only max. setpoint temperature"
In this setting, no setpoint temperatures are permitted in Cooling mode related to the Comfort, Standby and Night modes, which are greater than the maximum setpoints configured in the ETS. The maximum setpoint temperature is specified in the "Max. setpoint temperature in Cooling mode" parameter and be configured within the limits 20 °C to 35 °C in 1 °C levels.
With an active limit, no larger setpoint can be set in cooling operation, e.g. by a basic setpoint change or a setpoint shift. However, heat protection is not influenced by the setpoint temperature limit.
The maximum setpoint temperature configured in the ETS generally relates to the Comfort setpoint temperature of Cooling mode. In other operating modes, the temperature distance to Comfort mode must be taken into account. Example...
The maximum setpoint temperature is configured to 26 °C. The Standby setpoint temperature is configured to 2 K higher than the Comfort setpoint temperature. The result of this is that, for command value limiting, the setpoint temperature in Standby operating mode is limited to 28 °C. The setpoint temperature limit applies to Night mode in the same way.

- Setting "Max. setpoint temperature and difference to outdoor temperature"
This setting is a combination of the two above-mentioned settings. In the downward direction, the setpoint temperature is limited by the maximum outdoor temperature difference, whilst in the upward direction, the limit is made by the maximum setpoint. The maximum setpoint temperature has priority over the outdoor temperature difference. This means that the controller keeps on raising the setpoint temperature upwards according to the difference to the outdoor temperature configured in the ETS until the maximum setpoint temperature or the heat protection temperature is exceeded. Then the setpoint is limited to the maximum value.

i The setpoint display of the pushbutton sensor always shows the setpoint of the controller, taking the setpoint limit into account.

A setpoint limit enabled in the ETS can be activated or deactivated as necessary using a 1-bit object. For this, the "Activation of the setpoint temperature limit via object in cooling mode" parameter can be set to "Yes". In this case, the controller only takes the setpoint limit into account, if it has been enabled via the object "Cooling setpoint temp. limit" ("1" telegram). If the limitation is not enabled ("0" telegram), the cooling setpoint temperatures are not limited. After a device reset (bus voltage return, programming operation), the object value is "0", meaning that the setpoint limit is inactive.

i The setpoint limit has no function in Heating mode.

Adjusting the basic temperature / temperature for Comfort mode

With the setpoint temperatures for Comfort, Standby and Night mode, attention has to be paid to the fact that all setpoints depend on each other as all values are derived from the basic temperature (basic setpoint). The "Basic temperature after reset" parameter in the "Room temperature measurement -> Controller general -> Setpoint" parameter page determines the basic setpoint which is loaded when the device is programmed via the ETS. The 2-byte object "Basic setpoint" provides the option of changing the basic temperature, and thus all the dependent setpoint temperatures 'at a later date'.

A change via the object must always be enabled in the ETS by configuring the parameter "Change the basic temperature setpoint via bus" to "Approve". If the basic setpoint adjustment via the bus is disabled, the "Basic setpoint" object will be hidden (setting "deactivated").

- i** The push button module rounds the temperature values received via the "basic setpoint" object and matches them to the level value of the basic setpoint shift (0.5 K).

In addition or as an alternative, the basic setpoint can also be changed using local control in the second operating level of the pushbutton sensor. The basic setpoint is set directly in the individual operating modes "Heating" or "Cooling" using the appropriate comfort temperature. In the combined operating mode "Heating and cooling", the basic setpoint is set either directly (asymmetrical deadband) or indirectly (symmetrical deadband) using the comfort temperature for heating according to the deadband positions configured in the ETS. The comfort setpoint temperature for cooling is then derived directly from the comfort setpoint for heating, taking the deadband into account.

The adjustment option of the basic setpoint in the second operating level must be enabled in the ETS. Local adjustment must be enabled using parameters in the parameter node "Room temperature control -> Controller general -> Second operating level".

- i** The deadband position (symmetrical / asymmetrical) in "Heating and cooling" cannot be changed with local adjustment.

One has to distinguish between two cases, defined by "Apply change to basic temperature setpoint permanently" parameter, if the basic setpoint has been adjusted, via local operation or via the object...

- Case 1: The basic setpoint adjustment is permanently accepted ("Yes" setting):
If, with this setting, the basic temperature setpoint is adjusted, the controller saves the value permanently to the EEPROM. Saving in this device memory takes place without a decimal point (e.g. basic setpoint value specification by object = 21.5 °C -> 21 °C saved)! The newly adjusted value will overwrite the basic temperature originally configured via the ETS after a reset! This is the only way to keep the adjusted basic setpoint even after change-over of the operating mode or after a reset.
With this setting, it should be noted that frequent changing of the basic temperature (e.g. several times a day) can affect the product life of the device as the non-volatile storage (EEPROM) is designed for less frequent write access. In addition, the "Basic setpoint" object is not bidirectional, meaning that a basic setpoint changed by local control is not signalled back to the KNX/EIB. A previously saved basic setpoint remains active after the return of bus voltage, providing that the device was not programmed by the ETS.
- Case 2: The basic setpoint adjustment is only temporarily accepted ("No" setting):
The basic setpoint, which was set on the room temperature controller or received via the object, stays only temporarily active in the current operating mode. In case of a bus voltage failure or following a change-over to another operating mode (e.g. Comfort followed by Standby), the basic setpoint set via local control or received via the object will be discarded and replaced by the value which was originally configured in the ETS.

- i** With local operation in the second operating level, it must be taken into account that temperature changes, made using the display buttons, are only saved to the device when the operating level is exited by pressing both display buttons simultaneously. No save takes place when the second operating level is exited (no button pressed for 20 s). The controller does not detect an adjustment of the temperature value and therefore does not apply the change.

Adjusting the temperatures for Standby and Night mode

A basic setpoint change has an impact on the temperature setpoints for Standby and Night mode. Since the setpoint temperatures for the "Standby" and "Night" operating modes are derived from the Comfort setpoint temperature, the Standby and Night temperatures will shift in linear fashion by the change of the basic setpoint value. The shift takes place taking the increase or decrease values for Standby and Night mode either configured in the ETS or made indirectly locally into account.

In addition or alternatively to a basic setpoint change, it is possible, through local control on the pushbutton sensor in the second operating level, to set other temperature values for Standby and Night mode to those configured in the ETS. In this case, the originally configured decrease or increase values will be replaced by the new values resulting from the locally adjusted temperature setpoints. Independently of the "Accept modification of the basic temperature setpoint value permanently" parameter, the temperature setpoints for the standby or night mode will always be stored in the non-volatile EEPROM memory. Local adjustment must be enabled using parameters in the parameter node "Room temperature control -> Controller general -> Second operating level".

Basic setpoint shift

In addition to the setting of individual temperature setpoints via the ETS, it is possible to shift the basic setpoint within a settable range anytime via local operation or via the basic setpoint object at any time, either using the display buttons or with the "Setpoint shift" button function, if this is configured to a function button of the push button sensor. Each time a button is pressed, the basic setpoint is shifted upwards or downwards by one level (depending on the button operation and configuration). A long press of the display button will continue the adjustment. If a function button is pressed for setpoint shifting, the adjustment only takes place in levels (not continuously).

The icon  on the display indicates that a basic setpoint shifting has been set. The adjusted temperature value is instantly accepted as the new setpoint when a function button is pressed. When an adjustment is made using the display buttons, the value is only valid if no further adjustment takes place within 20 s or another function button is pressed as confirmation.

The adjustable temperature range for a basic setpoint shift is defined via the "Upward setting option of basic setpoint temperature" or "Downward setting option of basic setpoint temperature" parameters. It is possible to shift the current setpoint by a maximum of +/- 10 K. The incremental distance of a setpoint shift is permanently set to 0.5 K. The push button module rounds the temperature values received via the "basic setpoint" object and matches them to the level value.

i It has to be considered that a shift of the displayed setpoint temperature (temperature offset of the basic temperature) will directly affect the basic setpoint and as a result shift all other temperature setpoints.

A positive shift is possible up to the configured heat protection temperature. A negative shift is possible up to the set frost protection temperature.

The setpoint temperatures of frost or heat protection mode cannot be shifted.

Whether a basic setpoint shifting only affects the currently active operating mode or whether it influences all other set-temperatures of the remaining operating modes is determined by the "Accept modification of shift of basic setpoint value permanently" parameter in the "Setpoints" parameter page...

- "No" setting:
The basic setpoint shifting carried out is in effect for only as long as the operating mode or heating/cooling mode has not changed or the basic setpoint is maintained. Otherwise the setpoint shift will be reset to "0".

- "Yes" setting:
In general, the shifting of the basic setpoint carried out affects all operating modes. The shifting is maintained even after change-over of the operating mode or the heating/cooling mode or readjusting the basic setpoint.

- i** Since the value for the basic setpoint shift is stored exclusively in volatile memory (RAM), the shift will get lost in case of a reset (e.g. bus voltage failure).
- i** A setpoint shift does not affect the temperature setpoints for frost or heat protection!

Communication objects for the basic setpoint shift:

The controller tracks the current setpoint shift in the communication object "Current setpoint shift" via the controller with a 1 byte counter value (acc. to KNX DPT 6.010 – representation of positive and negative values in a double complement). By connecting to this object the controller extensions are also able to display the current setpoint shift. As soon as there is an adjustment by one temperature increment in positive direction, the controller counts up the value by one digit. The counter value will be counted down by one digit, if there is a negative adjustment of the temperature. Thus the possible range of values for the object is determined by the setpoint's adjustment options. A value of "0" means that no setpoint shift has been adjusted.

Example:

Starting situation: current setpoint temperature = 21.0°C / Counter value in "Current setpoint shift" = "0" (no active setpoint shift)

After the setpoint shift:

- > A setpoint shift by one temperature increment in the positive direction will count up the value in the "Current setpoint shift" object by one = "1".
- > Current setpoint temperature = 21.5°C
- > An additional setpoint shift by one temperature increment in the positive direction will again count up the value in the "Current setpoint shift" object by one = "2".
- > Current setpoint temperature = 22.0°C
- > A setpoint shift by one temperature increment in the negative direction will count down the value in the "Current setpoint shift" object by one = "1".
- > Current setpoint temperature = 21.5°C
- > An additional setpoint shift by one temperature increment in the negative direction will again count down the value in the "Current setpoint shift" object by one = "0".
- > Current setpoint temperature = 21.0°C
- > An additional setpoint shift by one temperature increment in the negative direction will again count down the value in the "Current setpoint shift" object by one = "-1".
- > Current setpoint temperature = 20.5°C, etc. ...

In addition, the controller's setpoint shift can be externally adjusted via the communication object "Preset setpoint shift". This object has the same data point type and range of values as the object "Current setpoint offset" (see above). By connecting to the "Setpoint shift specification" object the controller extensions are able to directly adjust the current setpoint shift of the controller. As soon as the controller receives a value, it will adjust the setpoint shift correspondingly. Values that lie within the possible value range of the basic setpoint shift can be

directly jumped to. The controller monitors the received value independently. As soon as the external preset value exceeds the limits of the adjustment options for the setpoint shift in positive or negative direction, the controller will correct the received value and adjust the setpoint shift to maximum. Depending on the direction of the shift, the value feedback is set to the maximum value via the communication object "Current setpoint shift".

- i** When a function button for the setpoint shift is pressed on the device, the current shift is displayed on the device display in the same way as for operation using the display buttons.

Transmitting the setpoint temperature

The setpoint temperature, which is given by the active operating mode or has been subsequently adjusted, can be actively transmitted onto the bus via the 2-byte "Set temperature" object. The "Transmission at setpoint temperature modification by..." parameter in the "Room temperature control -> controller general -> setpoint values" parameter node determines the temperature value by which the setpoint has to change in order to have the setpoint temperature value transmitted automatically via the object. Possible temperature value changes lie within a range of 0.1 K and 25.5 K. The setting "0" at this point will deactivate the automatic transmission of the set temperature.

In addition, the setpoint can be transmitted cyclically. The "Cyclical transmission of setpoint temperature" parameter determines the cycle time (1 to 255 minutes). The value "0" will deactivate the periodical transmission of the setpoint temperature value. It has to be pointed out that with deactivated periodical transmission and deactivated automatic transmission, no setpoint temperature telegrams will be transmitted in case of a change.

Setting the "Read" flag on the "Setpoint temperature" object makes it possible to read out the current setpoint. Following the return of bus voltage or after re-programming via the ETS, the object value will be initialised according to the current setpoint temperature value and actively transmitted to the bus.

4.2.4.2.6 Room temperature measurement

Basic principles

The room temperature regulator periodically measures the actual temperature of the room and compares it with the given setpoint temperature of the active operating mode. The control algorithm calculates the adjusted command value from the difference between actual and setpoint temperatures. In order to ensure a fault-free and effective room temperature control, it is very important to determine the exact actual temperature.

The room temperature controller possesses an integrated temperature sensor, using which the room temperature can be detected. Alternatively (e.g. if the room temperature controller has been installed in an unfavourable location or operates in difficult conditions, for example, in a moist atmosphere) or in addition (e.g. in large rooms or halls), a second temperature sensor can be used to determine the actual value. This second sensor can either be a room temperature controller coupled via the KNX/EIB or a controller extension with temperature detection (external sensor). Alternatively, it is possible to connect a wired temperature/remote sensor directly to the push button sensor (see chapter 1.3. Accessories).

When choosing the installation location of the controller or the external sensor, the following points should be considered...

- The controller or temperature sensor should not be used in multiple combinations, especially together with flush-mounted dimmers.
- Do not install the temperature sensor in the area of large electrical consumers (avoid heat influences).
- The push button sensor should not be installed in the vicinity of radiators or cooling systems.
- The temperature sensor should not be exposed to direct sun.
- The installation of sensors on the inside of an outside wall might have a negative impact on the temperature measurement.
- Temperature sensors should be installed at least 30 cm away from doors, windows or ventilation units and at least 1.5 m above the floor.

i Room temperature measurement by the device is always active, irrespective of the "Room temperature control" or "Controller extension" functions and can thus be used independently (e.g. for simple measurement and indication of a room temperature without feedback control).

External sensor connection

The pushbutton sensor offers the option of direct connection of a wired temperature/remote sensor. In addition, the rear side of the device housing can offer an additional connection option between the connections for the bus line and the additional power supply. The optionally available temperature/remote sensor (21) can be connected to the 2-pole plug connection (8).

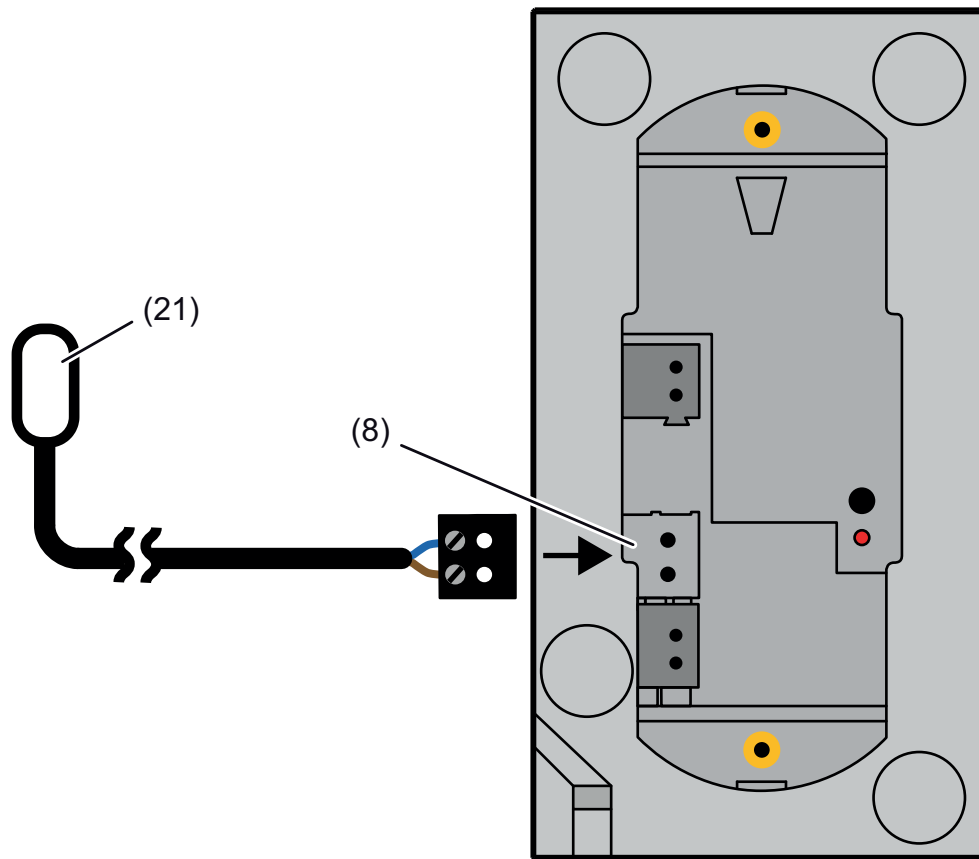

Figure 47: Connection for wired temperature/remote sensor

(8) Plug connection for wired temperature/remote sensor

(21) Wired temperature/remote sensor (optionally-available accessory part)

If a wired temperature/remote sensor is connected to the pushbutton sensor, the sensor connection must be activated in the device software. For this, the ETS parameter "Temperature/remote sensor connected" in the "Room temperature control -> Controller general -> Room temperature measurement" parameter node should be set to "Yes". If this parameter is configured to "No", then the sensor connection is inactive.

The wired temperature sensor can execute two alternative functions. The "Temperature/remote sensor used for" parameter specifies the type of use as follows...

- "Room temperature measurement" setting
The wired temperature sensor is used to measure the local room temperature. This means that the sensor is evaluated exclusively as an external sensor for room temperature measurement .
IMPORTANT: in this case, the "Temperature/remote sensor" communication object may not be written with other telegrams by other bus subscribers (do not set the "Write" flag). This would otherwise cause an incorrect temperature evaluation. Additional extensions for room temperature measurement cannot then be implemented. However, the object can be read out meaning that the unadjusted (!) temperature value of the remote sensor can, for example, be displayed separately in a visualisation.

- "Temperature limiter (underfloor heater)" setting
The wired temperature sensor is used to measure the temperature of an underfloor heating system. This permits temperature limitation .
IMPORTANT: in this case, the "Temperature/remote sensor" communication object may not be written with other telegrams by other bus subscribers (do not set the "Write" flag). This would otherwise cause an incorrect temperature evaluation.

Temperature detection and measured value formation

The "Temperature detection" parameter in the "Room temperature control -> Controller general -> Room temperature measurement" parameter node specifies the sensors to detect the room temperature. The following settings are possible...

- "internal sensor"
The temperature sensor integrated in the room temperature controller is activated. Thus, the actual temperature value is determined only locally on the device. In this parameterisation the feedback control will start directly after a device reset.

- "External sensor" or "Temperature/remote sensor"
The actual temperature is determined solely via the external temperature sensor or by the wired temperature/remote sensor. The internal sensor is inactive. In this case, the sensor can either be a wired temperature sensor connected to the controller or, alternatively, a KNX/EIB room thermostat coupled via the 2-byte object "External temperature sensor" or a controller extension with temperature detection.
IMPORTANT: if the wired temperature/remote sensor is used to measure the room temperature, the "Temperature/remote sensor" communication object visible in the ETS may not be written to by other bus subscribers (do not set the "Write" flag). This would otherwise cause an incorrect temperature evaluation. Additional extensions for room temperature measurement cannot then be implemented. However, in this case, the object may be read out (set the "Read" flag).
If the wired sensor is not used, i.e. the external temperature value is received by the KNX/EIB, then the room temperature controller can request the current temperature value cyclically. For this the parameter "Request time for external sensors..." must be set to a value > "0". The request interval can be configured within the limits of 1 minute to 255 minutes. After a device reset the room temperature controller will first wait for a valid temperature telegram until the feedback control starts and a command value or fan level, if applicable, is output.

- "Internal and external sensor" or "Internal sensor and temperature/remote sensor"
In this setting, the internal as well as the external temperature sensor or the temperature/remote sensor are active. The sensor can either be a wired temperature sensor connected to the controller or, alternatively, a KNX/EIB room thermostat coupled via the 2-byte object "External temperature sensor" or a controller extension with temperature detection.
IMPORTANT: if the wired temperature sensor is used to measure the room temperature, the "Temperature/remote sensor" communication object visible in the ETS may not be written to by other bus subscribers. This would otherwise cause an incorrect temperature evaluation. Additional extensions for room temperature measurement cannot then be implemented. However, in this case, the object may be read out (set the "Read" flag).
If the wired sensor is not used, i.e. the external temperature value is received by the KNX/EIB, then the room temperature controller can request the current temperature value cyclically. For this the parameter "Request time for external sensors..." must be set to a value > "0". The request interval can be configured within the limits of 1 minute to 255 minutes. After a device reset the room temperature controller will first wait for a valid temperature telegram until the feedback control starts and a command value or fan level, if applicable, is output.
On evaluating the internal and the external sensor / remote sensor, the real actual temperature is made up from the two measured temperature values. The weighting of the temperature values is defined by the "Creation of measuring value internal against external" parameter. Depending on the different locations of the sensors or a possible non-uniform heat distribution inside the room, it is thus possible to adjust the actual temperature measurement. Often, those temperature sensors that are subject to negative external influences (for example, unfavourable location because of exposure to sun or heater or door / window directly next to it) are weighted less heavily.

Example: a room temperature controller is installed next to the entrance to the room (internal sensor). An additional external temperature sensor has been mounted on an inner wall in the middle of the room below the ceiling.
Internal sensor: 21.5 °C
External sensor: 22.3 °C
Determination of measured value: 30 % to 70 %

-> $T_{\text{Result internal}} = T_{\text{internal}} \cdot 0.3 = 6.45 \text{ °C}$,
-> $T_{\text{Result external}} = T_{\text{external}} \cdot 0.7 = 15.61 \text{ °C}$
-> $T_{\text{Result actual}} = T_{\text{Result internal}} + T_{\text{Result external}} = \underline{22.06 \text{ °C}}$

Calibrating the measured values

In some cases during room temperature measurement, it may be necessary to adjust the temperature values of the internal and the external sensor of the wired temperature/remote sensor. Adjustment becomes necessary, for example, if the temperature measured by the sensors stays permanently below or above the actual temperature in the vicinity of the sensor. To determine the temperature deviation, the actual room temperature should be detected with a reference measurement using a calibrated temperature measuring device.

The parameter "Internal sensor adjustment..." and/or "External sensor adjustment..." / "Temperature/remote sensor adjustment..." in the "Room temperature control -> Controller general -> Room temperature measurement" parameter node can be used to configure the positive (temperature increase, factors: 1 ... 127) or negative (temperature decrease, factors -128... -1) temperature calibration in levels of 0.1 K. Thus, the calibration is made only once statically and is the same for all operating modes of the controller.

- i** The measured value has to be increased, if the value measured by the sensor lies below the actual room temperature. The measured value has to be decreased, if the value measured by the sensor lies above the actual room temperature.
- i** During room temperature control, the controller always uses the adjusted temperature value to calculate the command values. The adjusted temperature value is transmitted to the bus via the "Actual temperature" object (see "Transmission of the actual temperature"). When determining the measured value using the internal and external sensor, the two adjusted values are used to calculate the actual value. If necessary, the unadjusted room temperature of the internal temperature sensor can additionally be transmitted to the bus as an information value (object "Actual temperature, unadjusted") and, for example, be evaluated in other bus devices or displayed in visualisations.
- i** Temperature adjustment only affects the room temperature measurement. A wired temperature sensor for limiting the temperature of an underfloor heating system is not adjusted by the named parameters.

Transmission of the actual temperature

The determined actual temperature can be actively transmitted to the bus via the 2-byte "Actual temperature" object. The parameter "Transmission when room temperature change by..." parameter in the "Room temperature control-> Room temperature measurement" parameter node specifies the temperature value by which the actual value has to change in order to have the actual temperature value transmitted automatically via the object. Possible temperature value changes lie within a range of 0.1 K and 25.5 K. The setting to "0" at this point will deactivate the automatic transmission of the actual-temperature.

In addition, the actual value can be transmitted periodically. The "Cyclical transmission of the room temperature" parameter determines the cycle time (1 to 255 minutes). The value "0" will deactivate the periodical transmission of the actual temperature value.

Setting the "Read" flag on the "actual temperature" object makes it possible to read out the current actual value at any time over the bus. It has to be pointed out that with deactivated periodical transmission and deactivated automatic transmission, no more actual-temperature telegrams will be transmitted".

Following the return of bus voltage, new programming via the ETS, the object value will be updated according to the actual temperature value and transmitted on the bus. In case a temperature value telegram has not been received from the external sensor via the object "External temperature sensor" when evaluating an external temperature sensor, only the value provided by the internal sensor will be transmitted. If only the external sensor is used, then the value "0" is located in the "Actual temperature" object after a reset. For this reason, the external temperature sensor should always transmit the current value after a reset.

During room temperature control, the controller always uses the adjusted temperature value to calculate the command values. The adjusted temperature value is transmitted to the bus via the "Actual temperature" object. If necessary, the unadjusted room temperature can additionally be

transmitted to the bus as an information value via the object "Actual temperature, unadjusted" and, for example, be displayed in visualisations. The object for the unadjusted temperature is updated and transmitted at the same times as the "Actual temperature" object.

Underfloor heating temperature limit

The temperature limit can be activated in the controller in order to protect an underfloor heating system. If the temperature limit is enabled in the ETS, the controller continuously monitors the floor temperature. Should the floor temperature exceed a specific limiting value on heating, the controller immediately switches the command value off, thus switching the heating off and cooling the system. Only when the temperature falls below the limiting value, minus a hysteresis of 1 K, will the controller add the most recently calculated command value.

In the ETS, the temperature limit can be activated by setting the "Underfloor heating temperature limit available" parameter in the "Room temperature control -> Controller general -> Room temperature measurement" to "Yes".

- i** It should be noted that the temperature limit only affects command values for heating. Thus, the temperature limit requires the controller operating modes "Heating" or "Heating and cooling" (see chapter 4.2.4.2.4. Operating mode switchover). The temperature limit cannot be configured in the operating mode "Cooling".

The temperature limit can also be used in a two-level feedback control with basic and additional levels. However, it must then be specified in the ETS to which level the limit shall apply. The limit can then either apply to the basic level or to the additional level for heating using the "Affects" parameter.

The underfloor heating temperature to be monitored can be fed into the controller in two ways...

- Feed by KNX/EIB communication object "Floor temperature".
As soon as the temperature limit is enabled in the ETS, the 2-byte object "Floor temperature" becomes visible. This object can be used to inform the controller of the current floor temperature using suitable temperature value telegrams from other bus devices (e.g. analogue input with temperature sensor, etc.).
- Feed by wired temperature/remote sensor.
In this case, the wired temperature sensor connected directly on the room temperature controller is used to measure the temperature of an underfloor heating system (see page 131). For this, the parameter "Temperature/remote sensor used for" in the "Room temperature control -> Controller general -> Room temperature measurement" parameter node should be configured to "Temperature limiter (underfloor heating)".
IMPORTANT: in this case, the "Temperature/remote sensor" communication object may not be written with other telegrams by other bus subscribers (do not set the "Write" flag). This would otherwise cause an incorrect temperature evaluation.

The maximum limit temperature, which the underfloor heating system may reach, is specified in the ETS using the "Maximum underfloor heating system temperature" parameter. The temperature can be set to a value between 20 and 70 °C. If this temperature is exceeded, the controller switches the underfloor heating system off using the command value. As soon as the floor temperature has fallen 1 K under the limit temperature, the controller switches the command value on again, assuming that this is intended in the control algorithm. The 1 K hysteresis is fixed and cannot be changed.

- i** Depending on the configuration, the temperature may have a strong impact on the controller behaviour. Poor parameterisation of the limit temperature (limit temperature near to the room/setpoint temperature) means that it is possible that the specified setpoint temperature for the room can never be reached!

4.2.4.2.7 Command value and status output

Command value objects

The format of the command value objects are determined depending on the control algorithm selected for heating and / or cooling and, if applicable, also for the additional levels. 1 bit or 1 byte command value objects can be created in the ETS. The control algorithm calculates the command values in intervals of 30 seconds and outputs them via the objects. With the pulse width modulated PI control (PWM) the command value is updated, if required, solely at the end of a time cycle.

Possible object data formats for the command values separately for both heating/cooling operating modes, for the basic and the additional level or for both control circuits are...

- Continuous PI control: 1 byte
- Switching PI control: 1 bit + additionally 1 byte (for example for the status indication with visualisations),
- Switching 2-point feedback control: 1 bit.

Depending on the selected heating/cooling operating mode, the controller is able to address heating and / or cooling systems, to determine command values and to output them via separate objects. One distinguishes between two cases for the "Heating and cooling" mixed operating mode...

- Case 1: Heating and cooling system are two separate systems
In this case the "Transmit heating and cooling command value to one common object" parameter should be set to "No" in the "Room temperature control -> Controller functions" parameter node. Thus, there are separate objects available for each command value, which can be separately addressed via the individual systems.
This setting allows to define separate types of control for heating and cooling.
- Case 2: Heating and cooling system are a combined system
In this case the "Transmit heating and cooling command value to one common object" parameter may be set, if required, to "Yes". This will transmit the command values for heating and cooling to the same object. In case of a two-level feedback control, another shared object will be enabled for the additional levels for heating and cooling.
With this setting it is only possible to define the same type of feedback control for heating and for cooling as the feedback control and the data format must be identical. The ("Type of heating / cooling") control parameter for cooling and heating still has to be defined separately.
A combined command value object may be required, for example, if heating as well as cooling shall take place via a single-pipe system (combined heating and cooling system). For this, the temperature of the medium in the single-pipe system must be changed via the system control. Afterwards the heating/cooling operating mode is set via the object (often the single-pipe system uses cold water for cooling during the summer, hot water for heating during the winter).

If required, the command value can be inverted before the transmission to the KNX/EIB. With output via a combined object, the parameters "Output of heating command value", "Output of cooling command value" or "Output of command values..." output the command value in inverted fashion according to the object data format. The parameters for inverting the additional level(s) are additionally available in the two-level control.

The following applies...

For continuous command values:

-> Not inverted: Command value 0 % ... 100 %, value 0 ... 255

-> Inverted: Command value 0 % ... 100 %, value 255 ... 0

For switching command values:

-> Not inverted: Command value off / on, value 0 / 1

-> Inverted: Command value off / on, value 1 / 0

Automatic transmission

On automatic transmission, a distinction is made with regard to the type of control...

- **Continuous PI control:**
In case of a continuous PI control, the room temperature controller calculates a new command value periodically every 30 seconds and outputs it to the bus via a 1-byte value object. The change interval of the command value can be determined in percent according to which a new command value is to be output on the bus via the "Automatic transmission on change by..." parameter in the "Room temperature control -> Controller general -> Command values and status output" parameter node. The change interval can be configured to "0" so that a change in the command value will not result in an automatic transmission.
In addition to the command value output following a change, the current command value value may be periodically transmitted on the bus. In addition to the times when changes are to be expected, other command value telegrams will be output according to the active value after a configurable cycle time. This ensures that during a periodic access control of the command value in servo drive or in the addressed switching actuator, telegrams are received within the control interval. The time interval predetermined by the "Cycle time for automatic transmission..." parameter should correspond to the control interval in the actuator (cycle time in the controller is preferably to be configured smaller). The "0" setting will deactivate the periodic transmission of the actuating variable.
With continuous PI control it must be noted that if the cyclical and the automatic transmission are both deactivated, no command value telegrams will be transmitted in case of a change!

- **Switching PI control (PWM):**
In case of a switching PI control (PWM), the room temperature controller calculates a new command value internally every 30 seconds. In this feedback control, however, the update of the command value takes place, if required, solely at the end of a PWM cycle. The parameters "automatic transmission on change by..." and "Cycle time for automatic transmission..." are not enabled with this control algorithm. The parameter "Cycle time of the switching command value..." defines the cycle time of the PWM command value signal.

- **2-point control:**
In case of a 2-point feedback control, the room temperature and thus the hysteresis values are evaluated periodically every 30 seconds, so that the command values, if required, will change solely during these times. The "Automatic transmission on change by..." parameter is not enabled as this control algorithm does not calculate continuous command values.
In addition to the command value output following a change, the current command value value may be periodically transmitted on the bus. In addition to the times when changes are to be expected, other command value telegrams will be output according to the active value after a configurable cycle time. This ensures that during a periodic access control of the command value in servo drive or in the addressed switching actuator, telegrams are received within the control interval. The time interval predetermined by the "Cycle time for automatic transmission..." parameter should correspond to the control interval in the actuator (cycle time in the controller is preferably to be configured smaller). The "0" setting will deactivate the periodic transmission of the actuating variable.

Controller status

The room temperature controller can transmit its current status to the KNX/EIB. For this purpose, an optional collective status signal (1 byte type) or, alternatively, one of up to eight single status signals (1 bit type) are available. The "Controller status" parameter in the "Room temperature control -> Controller general -> Command value and status output" parameter branch will enable the status signal and set the status format...

- "Controller status" = "Controller general":
The 1-byte "Controller status" object contains the entire status information (see Table 8). The status will be actively transmitted to the bus in cycles every 30 seconds (provided that the "Transmission" flag has been set), but only on changes. The status can be read out by setting the "Read" flag.

Bit of the status telegram	Meaning
0	On "1": Comfort operation activated
1	On "1": Standby mode active
2	On "1": Night mode active
3	On "1": Frost/heat protection mode active
4	On "1": Controller disabled
5	On "1": Heating, on "0": Cooling
6	On "1": Controller inactive (deadband)
7	On "1": Frost alarm ($T_{\text{Room}} \leq +5 \text{ }^{\circ}\text{C}$)

Table 8: Bit encoding of the 1 byte status telegram

- "Status indication of controller" = "Transmit individual state":
The 1 bit status object "Controller status, ..." contains the status information selected by the "Single status" parameter (see Table 9). The status will be actively transmitted to the bus in cycles every 30 seconds (provided that the "Transmission" flag has been set), but only on changes. The status can be read out by setting the "Read" flag.

Parameterisation for "Individual Status" "Single status"	Meaning on "1"	Meaning on "0"
Comfort operation activated	Comfort mode / extension active	No comfort mode
Standby mode activated	Standby mode activated	No standby mode
Night mode activated	Night mode activated	No night mode
Frost/heat protection active	Frost/heat protection active	No frost/heat protection
Controller disabled	Controller disabled (dew point operation)	Controller not disabled
Heating / cooling	Heating mode	Cooling mode
Controller inactive	Controller inactive (deadband)	Controller active
Frost alarm	Frost alarm ($T_{\text{Room}} \leq +5 \text{ }^{\circ}\text{C}$)	No frost alarm ($T_{\text{Room}} > +5 \text{ }^{\circ}\text{C}$)

Table 9: Meaning of the 1-bit single status signals

Meaning of the status signals:

Comfort-mode -> Is active if operating mode "Comfort \uparrow " or a comfort extension " \uparrow " or " \uparrow " is activated.

Standby -> Is active if the "Standby \uparrow " operating mode is activated.

Night-mode -> Is active if the "Night \uparrow " operating mode is activated.

Frost/heat protection -> Is active if the "Frost/heat protection \uparrow " operating mode is activated.

Controller disabled -> Is active if controller disable is activated \uparrow (dew point mode).

Heating / cooling -> Is active if heating is activated and inactive if cooling is activated. Inactive if controller is disabled.

Controller inactive -> Is active in the "Heating and cooling" operating mode when the measured room temperature lies within the deadband. This status information is always "0" for the individual "Heating" or "Cooling" operating modes. Inactive if controller is disabled.

Frost alarm -> Is active if the detected room temperature reaches or falls below + 5 °C. This status signal will have no special influence on the control behaviour.

- i** Upon a reset, status object will be updated after the initialisation phase. After this, the status will be updated cyclically every 30 seconds in parallel with the command value calculation of the controller command values.

Additional controller status

The additional controller status is a 1-byte object, in whose value various information is collected in orientated to bits. In this way, controller statuses, which are not available via the 'normal' 1-bit or 1-byte controller status, can be displayed on other KNX/EIB devices or processed further (see Table 10). For example, controller extensions can evaluate the additional status information, in order to be able to display all the necessary controller status information on the extension display.

The 1-byte object "Status signal addition" is a pure visualisation object, which cannot be written.

Bit of the status telegram	Meaning on "1"	Meaning on "0"
0	Normal operating mode	Forced operating mode
1	Comfort extension active	No comfort extension
2	Presence (Motion detector)	No presence (Motion detector)
3	Presence (Presence button)	No presence (Presence button)
4	Window opened	No window opened
5	Additional level active	Additional level inactive
6	Heat protection active	Heat protection inactive
7	Controller disabled (dew point operation)	Controller not disabled

Table 10: Bit encoding of the 1 byte additional status telegram

- i** Upon a reset, the additional status object will be updated after the initialisation phase. After this, the status will be updated cyclically every 30 seconds in parallel with the command value calculation of the controller command values.

4.2.4.2.8 Fan controller

Operating mode and fan levels

The room temperature control can be supplemented with a fan controller. This makes it possible to control the fan from heating and cooling systems operated by circulating air, such as fan coil units (FanCoil units), depending on the command value calculated in the controller or using manual operation. If necessary, the fan controller can be enabled separately by setting the "Fan controller available" parameter in the "Room temperature control -> Controller general" parameter node to "Yes". When the function is enabled additional parameters will appear in the ETS in the "Room temperature control -> Controller general -> Fan controller" as well as additional communication objects.

If the fan controller is enabled, the icon ✱ becomes visible in the display after the device is commissioned (ETS programming operation).

- i** The fan controller works only in conjunction with PI feedback controls with continuous or switching (PWM) command value output. In 2-point feedback control, the fan controller is inactive, even if the function is enabled in the ETS.

Depending on the operating mode of the room temperature control, as configured in the ETS (see chapter 4.2.4.2.1. Operating modes and operating mode change-over), various controller command values can be used as the basis for fan control. The "Fan operating mode" parameter specifies which command value of the controller controls the fan controller. With one-level room temperature control, it is possible to select whether the fan is activated during heating and/or during cooling. With two-level room temperature control, it is also possible for the fan controller to be set to the basic level or the additional level during heating and cooling. However, under no circumstances is it possible to use the basic and additional levels simultaneously for a fan controller within an operating mode.

Fan coil units are as a rule equipped with filters, and have multi-level blowers whose speed and thus ventilation output can be varied by means of fan level inputs. Three-level fans are often encountered in practice. For this reason, the fan controller of the room temperature controller supports up to three fan level outputs, for which the actually used number of levels (1...3) is set using the "Number of fan levels" parameter.

The controller controls the levels of a fan using bus telegrams. Usually, the fan level telegrams are received and evaluated by simple switching actuators. The electrical control of the fan level inputs of a fan coil unit takes place via these actuators. Depending on the data format of the objects of the controlled actuators, the switchover between the fan levels can either take place via up to three separate 1-bit objects or, alternatively, via one 1-byte object. The "Fan level change-over via" parameter defines the data format of the controller. With the 1-bit objects, each fan level discreetly receives its own object. With the 1-byte object, the active fan level is expressed by a value (see Table 11).

Fan level	Object value
Fan OFF	0
1	1
2	2
3	3

Table 11: Value meaning for 1 byte fan level object

Due to fan motors' inertia, as a rule there is a limit to how short the time intervals for switching the fan levels can be, i.e. there is a limit to how quickly the fan speed can be varied. Often the technical information for a fan coil unit specifies change-over times that the fan controller must maintain for each fan level change-over. The change-over direction, i.e. whether the level is being increased or decreased, does not play any role here.

With a change-over via the 1-bit objects, when the fan level is changed by the controller, the

active fan level is first switched off before the new level is switched on. If the fan controller is working in automatic mode, the settable "Waiting time on level change-over" is maintained on change-over of the levels. For this short time, the fan level objects all receive the status "0 - Fan off". A new level is only then switched on when the waiting time has elapsed. Only one fan level output is ever switched on (changeover principle).

With change-over via the 1-byte object, on changing the fan level, the change-over takes place directly into the new level, without setting the "OFF" status. If the fan controller is working in automatic mode, the settable "Waiting time on level change-over" (dwell time) is always taken into account before change-over of the levels. With rapid level change-over, the change to the new level only takes place once the waiting time has elapsed.

- i** The change from level 1 to OFF always takes place immediately, without a waiting time. An optionally-configured switch-on level is applied directly.
- i** In manual mode, the "Waiting time on level switchover" is only significant for the switch-on level. Here, the fan levels can be switched over without a delay through manual operation.
- i** When changing from manual operation to automatic operation, the waiting time is taken into account in the case of a connected level change.

The fan level active in the current controller operating state is shown with using icons in the display of the device. In both automatic and manual operation (for a function description, please see the section "Automatic operation / manual operation"), the display takes place in the following manner...

- * Fan OFF
- *. Fan level 1 active
- *: Fan level 2 active
- *: Fan level 3 active

- i** The fans of a fan coil unit are - as described above - controlled by the fan level objects of the controller. The electromechanical valves for heating and/or cooling, integrated into the blower devices, can be controlled via suitable switching actuators using the objects "Heating message" or "Cooling message" (see page 96).
- i** The 1-byte object "Ventilation visualisation" can, if necessary, also be evaluated by other bus devices (e.g. visualisation - panel / PC software). It always transmit the current fan level as a 1-byte value, either automatically on a change or passively on reading out (value explanation according to Table 9).
- i** The objects of the fan levels are only updated by the controller. These objects may not be written to by other bus subscribers. Reading out is possible.
- i** After a device reset, the fan level objects and the visualisation object are updated and the status transmitted to the bus.

Automatic operation / manual operation

The fan controller distinguishes between automatic and manual operation. The switchover between the two operation modes takes place using the 1-bit object "Ventilation, auto/manual" or through the local operation of a button on the device configured for "Fan control".

The parameter "Interpretation object fan control automatic/manual" in the fan control parameter group defines with which switching value the automatic or manual operation is set via the communication object. Automatic mode is always active after a device reset.

- i** The "Ventilation, auto/manual" object transmits actively ("Transmit" flag set). When the operating mode is changed over using local control, the valid status is transmitted to the bus.

- i** Updates to the object value "Automatic mode active" -> "Automatic mode active" or "Manual mode active" -> "Manual mode active" do not produce any reaction.

Automatic mode:

The command value of the controller is used internally in the device for automatic control of the fan levels. As a transition between the levels, there are threshold values, defined according to the command value of the controller, which can be set using parameters in the ETS. If the command value exceeds the threshold value of a level, the appropriate level is activated. If the command value sinks below a threshold value, minus the configured hysteresis, then the change-over takes place into the next lowest fan level. The hysteresis value applies to all the threshold values.

The threshold values for the individual fan levels can be parameterised freely in the range from 1 ... 99 %. The threshold values are not checked for plausibility in the ETS, meaning that incorrect parameterisation is possible. For this reason, it must be ensured that the threshold values, compared to the level value, are configured in a rising direction (level 1 threshold value > level 2 threshold value > level 3 threshold value).

When the command value changes, and thus the fan level, it is only possible to switch directly into neighbouring levels (exception: switch-on level). Thus, in Automatic operation, it is only possible, for example, to switch from level 2 down to level 1 or up to level 3. If the command value change exceeds or undershoots the threshold values of multiple fan levels, then, starting with the current fan level, all the fan levels are activated in succession until the fan level specified by the command value is reached.

If the fan is switched off by the automatic system, then it runs on for the time configured as "Fan run-on time, heating" or "Fan run-on time, cooling", providing that these run-on times are configured in the ETS.

- i** In automatic mode, the fan level objects are updated according to the internal command value calculation (cyclically every 30 seconds) plus the waiting time configured for level change-over. Telegram transmission only takes place when the object values of the fan levels are changed. After a device reset, the fan level objects are updated and the status transmitted to the bus.
- i** If a switch-on level is configured in the ETS ("Start-up via level" parameter), then, before the automatic activation of a fan level, it is possible to switch to a level, specified in the ETS and usually higher, for a brief time according to the command value (see section "Switch-on level").
- i** The command value evaluated by the fan controller in Automatic mode can be optionally limited by in the top and bottom command value ranges by the parameters "Command value is 0% until internal command value is greater than" and "Command value is 100% as soon as internal command value is greater than". In addition, the command value can also be raised by a constant value by the "Command value offset" parameter (see page 148-149).

Manual operation:

With the local control of a button configured to "Function = Fan control" and "Button function = Manual control" on the device, the controller makes a distinction as to whether it was in automatic or manual mode at the time the button was pressed.

If the controller is in automatic mode, then pressing a button switches to manual mode. The parameter "Fan level on change-over to manual" then decides whether the fan level most recently set in automatic mode is maintained, the fan is switched off or a defined fan level is set (see also next section "Switch-on level").

If, at the time the button is pressed, the manual controller is already active, then the controller switches to the next highest fan level without a delay. If the fan is in the highest level, then pressing a button switches it back to the OFF level. From there, every additional press causes the fan level to be raised. The switch-on level is ignored.

If the fan is switched off manually from the highest level, then it runs on for the time configured as "Fan run-on time, heating" or "Fan run-on time, cooling", providing that these run-on times are configured in the ETS. If, during the run-on time, the manual control button is pressed again, the controller will terminate the run-on time. The fan switches off briefly and then switches immediately to level 1.

- i** The 1-bit object "Ventilation, auto/manual" only allows change-over between automatic and manual operation. It is not possible to switch the fan levels on using the object. This function is reserved solely for local control.
- i** Local actuation of a button configured to "Function = Fan control" and "Button function = Automatic" on the device deactivates manual operation and causes the controller to change over to automatic operation.
- i** When changing from manual operation to automatic operation, the waiting time configured in the ETS is taken into account in the case of a connected level change.
- i** The parameter "Fan level on change-over to manual" is not checked for plausibility in the ETS, meaning that an implausible parameterisation is possible. For this reason, care should be taken to ensure that there is no level in the configuration which is higher than the actual fan levels. If a level which does not exist is to be configured for the change-over to manual control, then the fan controller changes over to the maximum possible level when changing over to manual operation.
- i** In manual operation, the switch-on level only functions in certain situations (see next section "Switch-on level").

Switch-on level

The fan can, if it was switched off before and should now start up, be switched on at a defined switch-on level. This switch-on level can be any of the available fan levels, and is set in the ETS using the "Start-up via level" parameter. The switch-on level is generally one of the higher fan levels of a fan coil unit, so that at the beginning of a heating or cooling process the fan can start up correctly (reliable start-up of the fan motor through transfer of a higher torque, and thus a higher fan speed).

The switch-on level remains active for the "Waiting time on level change-over" configured in the ETS. In automatic operation, the controller only switches to the fan level specified by the command value, when the waiting time has elapsed. There is no change-over if, after the waiting time has elapsed, the fan level specified by the command value equals the switch-on level.

- i** If the controlled fan requires a longer period of time for the start-up, then the waiting time in the ETS should be configured to higher values (possible time range 100 ms ... 25.5 s). It should be noted that the waiting time is also taken into account on each level change-over in automatic operation (see page 143-144).

The switch-on level is always taken into account by the fan controller in automatic mode on switching the fan on (if it was previously switched off by the command value evaluation) and, in certain situations, after activation of manual operation. On changing over to manual operation, the behaviour of the fan depends on the settings of the parameter "Fan level on changing over to manual" and "Start-up via level" and the previous fan level in automatic operation as follows...

- If, due to the "Fan level on change-over to manual" parameter, a defined level from level 1 to level 3 is requested, the controller will set this level on activating manual operation. In this case, the parameter "Start-up via level" is not taken into account if the fan was most recently switched off in automatic operation.

- If, due to the "Fan level on change-over to manual" parameter, "Fan level OFF" is requested, the controller will switch the fan off during the change-over to manual operation. On subsequent pressing of the button for manual control, the "Start-up via level" parameter is taken into account and the switch-on level set. Then, the controller waits in this level until further manual operation.

 - If, due to the "Fan level on change-over to manual" parameter, no defined level is requested ("No change" setting) and the fan was switched off during automatic operation, then it will remain switched off on changing over to manual operation. On subsequent pressing of the button for manual control, the fan is switched to the first level. The "Start-up via level" parameter is thus not taken into account.
- i** A configured switch-on level is applied directly without a waiting time.
 - i** With a fan change-over via the 1-bit objects, when the fan level is changed by the controller, the active fan level is first switched off before the new level is switched on. In this case, the switch-off of a fan level and the subsequent changeover to a new fan level is not evaluated as a fan start-up, also meaning that the switch-on level is not set. In automatic operation, the switch-on level is only taken into account if the fan was switched off previously by the command value evaluation (command value < level 1 threshold value minus hysteresis) and then it is to start up using a new command value.
 - i** The start-up via the switch-on level also takes place after a change-over from manual operation to automatic operation, providing that the fan was most recently switched off in manual operation and, in automatic operation, a new command value requires the fan to be switched on.
 - i** The parameter "Start-up via level" is not checked for plausibility in the ETS, meaning that an implausible parameterisation is possible. For this reason, care should be taken to ensure that there is no switch-on level in the configuration which is higher than the actual fan levels. The fan controller automatically corrects a faulty parameterisation by activating level 1 for the start-up, meaning that the fan starts up normally without a switch-on level.

Fan level limit

To reduce the fan noise of a fan coil, the fan level limit can be activated. The level limit reduces the sound emissions by limiting the maximum fan level to a fan level value specified in the ETS by the "Level limit" parameter (limit level). The limitation can be switched on and off via a 1-bit "Fan, level limit" object, and thus activated in accordance with requirements, for example via a timer during night-time hours in order to reduce noise in bedrooms, or via "manual" operation of a pushbutton when a "quiet room" is needed (auditorium or the like). The limitation of the fan level is activated by receipt of a "1" telegram via the object "Fan, level limitation". Deactivation is therefore achieved through the receipt of a "0" telegram.

While a limitation is active, the fan controller prevents the fan from being switched to a higher level than the limitation level. If, at the instant that the limit is activated, the fan is running at a level that is greater than the limit level, then the fan level is immediately reduced to the limitation value. In this case the switching sequence of the individual levels and the waiting time configured in the ETS are also taken into account in the level change-over.

The limit level can be one of the available lower fan levels; the largest fan level (level 3) cannot be selected.

The level controller distinguishes between Automatic and Manual operation.

- i** The fan level limit overdrives the switch-on level. As a result, when the fan is switched on, if the limit is active, the level has an active limit and the switch-on limit is not started. In this case, the limit level is jumped to without waiting.
- i** The level limit has no effect with an activated fan forced position.

- i** The parameter "Level limit" is not checked for plausibility in the ETS, meaning that an implausible parameterisation is possible. For this reason, care should be taken to ensure that there is no limit level in the configuration which is higher than the actual fan levels. If a higher limit level is configured, then the limit has no effect.

Forced fan position

The controller provides the option of activating a forced fan position via the bus. With an active forced position, the fan levels can neither be controlled nor switched over in either automatic or manual mode. The fan remains in the forced state until the forced position is removed using the bus. In this manner, it is possible to switch the fan to a locked and controlled state, for example for servicing purposes.

As soon as a "1" telegram is received via the 1-bit object "Ventilation, forced position", the controller immediately sets the fan level configured in the ETS without delay. The fan can also be completely switched off. The only special feature when activating the forced position is the fact that the fan controller is in automatic operation and a waiting time elapses, due to a previous level change-over. In this case, the fan controller only switches to the forced position level without the waiting time elapsing.

The forced position is dominant. For this reason, it cannot be overdriven from automatic mode, manual mode, the level limit or fan protection. Only when the forced position is removed does the fan control begin to control the fan levels according to the active operating mode.

The removal takes place when a "0" telegram is received via the object "Ventilation, forced position". The fan always switches itself off first. In automatic operation, the controller then evaluates the active command value and, when the waiting time configured in the ETS has elapsed, switches to the required fan level, taking an optionally-configured switch-on level into account. In manual operation, the fan first remains switched off. The fan level is only raised when the manual control button is pressed again. If a switch-on level is configured, the controller will, when a button is pressed, switch to the switch-on level and remain there until further operation occurs.

- i** The parameter "Behaviour with forced position" is not checked for plausibility in the ETS, meaning that an implausible parameterisation is possible. For this reason, care should be taken to ensure that there is no fan level in the configuration which is higher than the actual fan levels. If a higher level is configured for behaviour in a forced position than the number of fan levels, then the fan controller will start up the maximum possible level when the forced position is activated.
- i** The forced fan position does not influence the control algorithm integrated in the controller. The command values of the PI feedback control continue to be transmitted to the bus, even with a forced fan.

Command value limiting values and command value offset

In automatic operation, the command value of the controller is used internally in the device to control the fan levels, according to the fan operating mode. As a transition between the levels, there are threshold values, defined according to the command value of the controller, which can be set using parameters in the ETS. The evaluation of the controller command values can be specially influenced for automatic fan control.

The command value to be evaluated for the fan controller can be influenced by the "Command value is 0% until internal command value is greater than" parameter in the lower command value range. The fan controller only evaluates the command value according to the configured threshold values when the internal command value of the controller exceeds the configured limiting value. With smaller command values, the fan remains at a standstill.

Similarly, the command value to be evaluated for the fan controller can be limited by the "Command value is 100% as soon as internal command value is greater than" parameter in the upper command value range. In this case, the controller evaluates command values which exceed the configured limiting value as 100%. This means that the fan works at full power even with command values not at the maximum.

The "Command value offset" parameter allows configuration of a constant command value offset for the fan. The fan controller always adds the configured offset to the command value to be evaluated. The effect of this is that the fan turns at greater power than required by the command value, according to the threshold values. The result of this is that, even if the command value is switched off, the fan will continue to work when the first command value threshold value is exceeded by the offset.

- i** A configured command value offset cannot not affect a command value of greater than 100%. The maximum command value of the fan controllers is therefore defined as 100 %.

Fan protection

The fan protection function allows the fan of a fan coil unit, which has not been active for some time, to be temporarily switched to the maximum level. In this way, the controller fan motors can be protected against stiffness. In addition, the fan blades and the heat exchanger of the fan coil unit are protected against dust against dust.

If the fan protection is to be used, it must be enabled using the parameter of the same name in the ETS. Fan protection can then be activated or deactivated directly using the 1-bit communication object "Ventilation, fan protection", for example using a KNX/EIB time switch.

If the fan protection object has the switching value "1", then the fan protection function is active. The fan then works at the highest possible fan level and overdrives automatic and manual operation. Fan protection can then be switched off again using the "0" switching value in the communication object.

The reaction of the fan to switching fan protection depends on the operating mode of the automatic fan system. In automatic operation, the fan switches back to the level determined by the command value of the room temperature control. In manual operation, the fan switches off and can then be switched on again by additional manual actuation. The "Start-up via level" parameter is taken into account here.

- i** Even if the fan controller is inactive due to the controller operating mode, it is possible to activate the fan using fan protection.
- i** With an active level limit, the maximum fan level of fan protection is specified by the limit level.
- i** For reasons of safety, fan protection is not carried out with an active forced position.
- i** If fan run-on times are configured in the ETS, then the fan is switched off after a delay when fan protection is deactivated.

4.2.4.2.9 Disable functions of the room temperature controller

Certain operation conditions may require the deactivation of the room temperature control. For example, the controller can be switched-off during the dew point mode of a cooling system or during maintenance work on the heating or cooling system. The "Via object" setting in the "Switch off controller (dew point operation)" parameter in the "Room temperature control -> Controller functionality" parameter node enables the 1-bit "Disable controller" object. In addition, the controller disable function can be switched off when set to "No".

In case a "1" telegram is received via the enabled disable object, the room temperature control will be completely deactivated. In this case all command values = "0" and the "Dew point operation"  icon lights up on the device display (wait for 30 sec command value update interval!). The controller, however, can be operated in this case.

The additional level can be separately disabled when in two-level heating or cooling mode. When set to "Yes", the "Additional level disabling object" parameter in the "Room temperature control -> Controller general" parameter node will enable the 1 bit "Disable additional level" object. In addition, the disable function of the additional level can be switched off when set to "No". In case a "1" telegram is received via the enabled disable object, the room temperature control is completely deactivated by the additional level. The command value of the additional level is "0" while the basic level continues to operate.

 A disable is always deleted after a reset (return of bus voltage, ETS programming operation).

4.2.4.2.10 Valve protection

Valve protection may be carried out periodically in order to prevent the addressed control valves of the heater or cooling system to become calcified or stuck. When set to "Yes", the "Valve protection" parameter in the "Room temperature control -> Controller functionality" parameter node activates valve protection.

This type of protection is generally started not only for non-active command value outputs, i.e. for outputs which have not requested any heating or cooling energy over the past 24 hours. For these outputs, by taking into account the following parameterisation the controller will periodically set the command value to the maximum value once a day for a duration of approx. 5 minutes...

Command value output not inverted:

-> 1-bit command value: "1", 1-byte command value: "255"

Command value output inverted:

-> 1-bit command value: "0", 1-byte command value: "0"

Thus even long closed valves will be opened briefly on a regular basis.

- i** A controller disable has no influence on the valve protection. This means that valve protection is carried out, even when the controller is disabled.
- i** The controller checks the 24 hr time cycle for valve protection using its internal clock. With a time-synchronised clock, valve protection takes place each day at 8.00 in the morning. If the time signal has not been synchronised via the bus for a long time, then the time is hidden in the display. However, the clock continues to run internally with the deviation to be expected. This means that the valve protection time may shift continually with an unsynchronised clock.

4.2.4.3 Room temperature controller extension

The glass sensor can be used for single-room temperature control. Depending on the operating mode, the current temperature setpoint and on the room temperature, command values for heating or cooling control and fan control can be sent to the KNX/EIB. Usually, these command values are then converted by a suitable KNX/EIB actuator, e.g. heating or switching actuators or directly by bus-compatible actuating drives, evaluated and converted to physical variables for air conditioning control.

The room temperature control is an independent function section of the glass sensor. It has its own parameter and object range in the ETS configuration. Therefore, the room temperature controller can be switched on or off, irrespective of the push button sensor function.

The controller function section of the glass sensor can either work as a main controller or as a controller extension. As the main controller, the room temperature controller function is fully switched on and the control algorithm activated. Only the main controller transmits control value telegrams. A controller extension itself is not involved in the regulating process. With it, the user can operate the single-room controller, i.e. the main controller from different places in the room. In this way, any number of operating extensions can be set up.

In this chapter, the functions of the room temperature controller are described as an extension.

4.2.4.3.1 Connection to room temperature controller

Function

The controller extension function can be activated to control a KNX/EIB room temperature controller. The controller extension function is enabled using the "Controller extension" setting of the parameter "Room temperature controller function" in the "Room temperature control" parameter node.

Typical KNX/EIB room temperature controllers generally offer different ways of influencing or visualising the room temperature control...

- Switching over between different modes of operation (e.g. "Comfort", "Night" ...) with different setpoint temperatures assigned to each mode by the thermostat.
- Signalling the presence of a person in a room. The signalling may also be combined with a configured switchover in the mode of operation.
- Readjustment of the setpoint temperature in levels which are referred in each case to the configured setpoint temperature of the current operating mode (basic setpoint shift).

The controller extension is operated using the push button functions of the device ("push button sensor" function section). In this way, it is possible to completely control a room temperature controller by changing the operating mode, by predefining the presence situation or by readjusting the setpoint shift. For this purpose, the buttons of the push button sensor selected as extension operation buttons must be configured for the "Controller extension" function (see chapter 4.2.4.3.2. Operating functions).

i It should be noted that an extension operation is possible with a button configuration. The controller extension function must be enabled in the "Room temperature control" parameter node. In all other cases, the controller extension function is not operational in the "push button sensor" function section.

Besides the operating function, the controller extension also possesses a display function. As on the main controller, various items of status information of the temperature controller can be shown on the device display. As the displayed states and information and also some operating functions are strongly dependent on the parameterisation of the main controller, the controller

extension must also be configured and thus match the functions of the main controller. These functions are matched by parameters in the parameter node "Room temperature control".

In addition to the status display on the device display, the push button sensor can – independently of the controller extension function – indicate the state of one or more room temperature controller with the status LEDs of the rockers or buttons. This feature permits the indication of operating modes or the bit-oriented evaluation of different status objects of controllers. In case of the controller extension functions "Setpoint shift" or "Presence function", the status LEDs can also signal the state of the corresponding functions directly.

Communication objects

The controller extension can work properly only if all extension objects are linked with the objects of the same function in the room temperature controller. The controller extension with the objects exists only once in the pushbutton sensor (indication in the object name "B.Controller extension"). All button functions configured for the controller extension act on the objects belonging to the extension. Objects with the same function can be linked together using identical group addresses, meaning that multiple controller extensions can affect one main controller. Table 12 shows all the communication objects of the controller extension and explains the function and the necessary connections to the objects of the main controller. With some objects, (e. g. "Controller status") care should be taken to ensure that the data formats (1 Bit, 1 Byte) agree.

Object on the Controller extension	Object on the main controller	Function / Meaning
B.Controller extension Operating mode switch-over	C.Input Operating mode switch-over	Change-over and transmission of the operating mode to the main controller.
B.Controller extension Forced operating mode change over	C.Input Operating mode forced-control	Change-over and transmission of the forced operating mode to the main controller.
B.Controller extension Presence button	C.Input / Output Presence object	Change-over and transmission of the presence status to the main controller. Also for activating the status-LED of a presence button.
B.Controller extension Setpoint shift specification	C.Input Setpoint shift specification	For setting a new counter value to adjust the setpoint for the main controller.
B.Controller extension Current setpoint shift	C.Output Current setpoint shift	Receiving the counter value to adjust the setpoint of the main controller.
B.Controller extension Controller status	C.Output Controller status	To show different icons in the display. Also for controlling the status LED of a function button to change over the operating mode.
D.Input controller extension Command value for heating	C.Output Command value for heating	Display of the heating icon (from 3 % command value)

D.Input controller extension Command value for cooling	C.Output Command value for cooling	Display of the cooling icon (from 3 % command value)
D.Input controller extension Cmd. value heating/ cooling	C.Output Cmd. value heating/cooling	Display of the heating or cooling icon (from 3 % command value)
D.Input controller extension Setpoint temperature	C.Output Setpoint temperature	Display of setpoint temperature in the display.
D.Input controller extension Status signal addition	C.Output Status signal addition	Shows a comfort extension in the display.
D.Input controller extension Ventilation visualisation	C.Output Ventilation visualisation	Shows the fan levels in the display, if fan control is activated in the main controller.

Table 12: Communication objects of the controller extension

- i** The actual room temperature can be detected by the communication objects of the room temperature measurement system, which are also available in the controller extension, and then shown in the display.

4.2.4.3.2 Operating functions

Operating mode switchover

Switchover of the controller operating mode can be effected in accordance with the standard function disable for room temperature controllers defined in the Konnex handbook with two 1-byte communication objects. The operating mode can be switched over with the normal and with the forced objects. The "B.Controller extension operating mode change-over" object offers a selection between the following operating modes...

- Comfort mode
- Standby mode
- Night mode
- Frost/heat protection mode

The "B.Controller extension forced operating mode change over" communication object has a higher priority. It permits forced switching between the following modes of operation...

- Auto (normal operating mode switchover)
- Comfort mode
- Standby mode
- Night mode
- Frost/heat protection mode

The operating mode transmitted to the bus on a button press of the controller extension is defined by the parameter "Operating mode on pressing the button". Depending on the configured functionality, it is possible that ...

- Either one of the above-mentioned modes is activated (single selection) on the press of the button,
- Or the device is switched over between two or three modes (multiple selection).

i Notes on multiple selection:

In order to ensure that a change-over from one operating mode to another works properly even from different locations, the operating mode objects of the controller and those of all controller extension push button sensors must be interlinked and have their "Write" flag set. In the objects concerned, this flag is set by default

By checking the linked operating mode switchover object, the controller extension knows which of the possible operating modes is active. Based on this information, the device switches over into the next operating mode in sequence when a button is pressed. In the event that none of the possible operating modes is active, the next operating mode in the sequence is set to "Comfort" mode (in case of "Standby ->Night" to "Standby" mode). As far as switching over between the forced operating modes and "Auto" is concerned, the device switches into the "Auto" operating mode when none of the configured operating modes is active.

i It is not possible to program a reaction on release of the button. A long button-press is evaluated in the same way as short one and switches into the corresponding operating mode insofar as this is acceptable for the controller.

i If a status LED is to indicate the current operating mode, the status LED function must be programmed for "Operating mode indication" and its status object be linked with the corresponding group address for operating mode change-over with normal or high priority.

Presence button

All buttons with their function set to "Presence button" are internally linked with the "B.Controller extension presence button" object. The parameter "Presence function on pressing the button" defines the object value transmitted to the bus on pressing a button.

In order to ensure that the object value transmitted in the "Presence TOGGLE" setting is always

the correct one, the presence object of the room temperature controller and the "Presence button" objects of the controller extension push button sensors must be interlinked and have their "Write" flag set. In the extension objects concerned, this flag is set by default.

It is not possible to program a reaction on release of the button. A long button-press is evaluated in the same way as short one and switches into the corresponding presence mode insofar as this is acceptable for the controller.

The status LED of the presence button can indicate both the presence status (setting "Button function indication active / inactive") and also the actuation of the button. In addition, the usual setting possibilities of the status LED are configurable as well .

Setpoint shift

The setpoint shift is another available function of the controller extension. It makes use of two 1-byte communication objects with data point type 6.010 (integer with sign). This extension function allows shifting of the basic setpoint for the temperature on a room temperature controller by pressing a button. Operation of the extension is generally the same as the operation of the main controller.

A button configured as a setpoint shift button reduces or increases the setpoint shift value on each press by one step width as specified by the main controller. The direction of the value adjustment is defined by the parameter "Setpoint shift on pressing the button". Releasing the button and a long press have no other functions.

Communication with main controller:

In order to enable the controller extension to effect a setpoint shift in a room temperature controller, the controller must have input and output objects for setpoint shifts. In this case, the output object of the controller must be linked with the input object of the extension unit and the input object of the controller must be linked with the output object of the extension via an independent group address (see chapter 4.2.4.3.1. Connection to room temperature controller). All objects are of the same data point type and have the same value range. A setpoint shift is interpreted by count values: a shift in positive direction is expressed by positive values whereas a shift in negative direction is represented by negative object values. An object value of "0" means that no setpoint shift has been activated.

Via the "B.Main controller current setpoint shift", the extensions are enabled to determine the current setpoint shift position. Starting from the value of the communication object, each button-press on an extension will adjust the setpoint in the corresponding direction by one count value level. Each time the setpoint is adjusted, the new shift is transmitted to the room temperature controller via the "B.Controller extension setpoint value specification" object of the controller extension. The controller itself checks the received value for the minimum and maximum temperature limits (see controller documentation) and adjusts the new setpoint shift if the values are valid. When the new count value is accepted as valid, the controller transfers this value to its output object for setpoint shifting and retransmits the value to the extension as positive feedback.









Due to the standard data point type used as the output and input object of the controller extension and the weighting of the individual level by the controller itself, each extension unit is able to determine whether a shift took place, in which direction it took place and by how many levels the setpoint was shifted. This requires that the communication objects are connected on all controller extensions and the controller.

The information for the step value as feedback from the controller enables the extension to continue the adjustment anytime at the right point. The extension units can likewise react to a reset of the setpoint shifting function by the controller.

- i** For the controller extension to be able to specify the setpoint shift correctly, the extension must also be configured and matched to the functions of the main controller. This function match is carried out using the "Upward setting option of basic setpoint temperature" and "Downward setting option of the basic setpoint temperature" parameters in the "Room temperature control" parameter node. These parameters must agree with the settings of the parameters of the same name in the main controller.
- i** When a button for the setpoint shift is pressed, the current shift is displayed on the device display in the same way as for operation using the display buttons. However, with the controller extension, only a relative setpoint shift can be shown in the display (no absolute temperature value for setpoint shift). If a standardised display of the setpoint shift is required on the main controller and on the extension, then the main controller must also be configured to a relative display.

4.2.4.3.3 Display functions

Indication of the controller operating mode

The controller extension can indicate the current operating mode of the controller in the display. Just like on the controller itself the operating mode is indicated by the  (comfort),  (standby),  (night) and  (frost/heat protection) icons. A comfort extension   /   can also be shown in the display. This display information is obtained from the communication objects "B.Controller extension controller status" and "D.Input controller extension status signal addition". These objects should be connected to the main controller objects with the same function (see page 152-153)!

It is not possible to use the display information to distinguish whether the operating mode has been set via a forced object or via the 'normal' operating mode change-over in case of a KONNEX change-over. It is possible to change over the operating mode using the control function of the controller extension.

- i** It is not possible to change over the controller operating mode in the second operating level on a controller extension in local control.

Display of a setpoint shift

The controller extension can indicate on the display whether a basic setpoint shift has been adjusted on the controller. If a basic setpoint shift is active, the extensions will show the  hand icon on the display. This requires that the "B.Controller extension current setpoint shifting" communication object is connected to the object of the same function in the main controller (see chapter 4.2.4.3.1. Connection to room temperature controller). A basic setpoint shift can also be set using the operating function of the controller extension (see chapter 4.2.4.3.2. Operating functions).



If one of the display buttons is pressed on the controller extension, then the setpoint shift is shown in the display. This display is always relative (no absolute temperature value). If a standardised display of the setpoint shift is required on the main controller and on the extension, then the main controller must also be configured to a relative display.

Indication of setpoint temperature

The controller extension can indicate the setpoint temperature of the room temperature controller in the display. If this indication is required, then the communication object "D.Input controller ext. setpoint temperature" should be linked with the object of the same function in the main controller. In addition, the display of the extension must be configured for the indication of the temperature setpoint. For this, display information in the "Display" parameter block must be configured to "Setpoint temperature" (see page 167).

- i** On the controller extension, the setpoint temperature will always be displayed as an absolute temperature value.

Indication of the heating and cooling messages

The main controller can indicate on the display that heating and cooling energy is requested by the heating or cooling systems. This is indicated by the  icon for heating or by the  icon for cooling for command values of 3 % or higher. With smaller command values, the icons are deactivated on the controller extensions.

For the indication to function, the communication objects for the controller command values of heating mode and/or cooling mode of the extension and main controller must be connected (see page 152-153).

The command value format are strongly dependent on the parameterisation of the main controller. For the controller extension to be able to evaluate the command value telegrams correctly, the extension must also be configured and thus matched to the functions of the main controller. These functions are matched by the following parameters in the parameter node "Room temperature control"...

"Controller operating mode", "Controller transmits heating and cooling command values to a shared object" (only on "Controller operating mode" = "Heating and cooling"),
"Type of feedback control", "Controller outputs command value ... in inverted form".

Fan levels display

As on a main controller, a controller extension can also indicate the current fan level of a fan controller in the display. There is no difference in the control function of the fan icon ****.*:*:**, compared with the main controller function.

For the fan level indication to function, the communication object "D.Input controller extension ventilation visualisation" must be connected to the object of the same function of the main controller.

The fan level display must be enabled separately on the controller extension using the "Controller fan control available" parameter. In addition, it is necessary to set with how many fan levels (1...3) the main controller works.

4.2.4.3.4 Room temperature measurement

Room temperature measurement by the device is always active, irrespective of the "Room temperature control" or "Controller extension" functions and can thus be used independently (e. g. for simple measurement and indication of a room temperature without feedback control). With a controller extension, the function of the room temperature measurement by the internal or external sensor or by the wire temperature/remote sensor is as described in the chapter "Room temperature controller" (see chapter 4.2.4.2.6. Room temperature measurement).

4.2.4.3.5 Behaviour after a device restart

The different indication and operating functions of the controller extension are controlled via different communication objects as described in the previous chapters. A main controller must transmit the current status to the extensions, i.e. updating the communication objects so that, after a programming operation or after the return of bus voltage, all the status information is available for the initialisation of the extension. This takes place automatically for some objects during the initialisation of the main controller.

To ensure that all the objects are initialised correctly, some communication objects of the controller extension can also initialise automatically after a device restart as an option. For this, the parameter "Value request from controller extension?" the parameter node "Room temperature control" can be set to "Yes". The update takes place after a reset by means of a ValueRead telegram to the room temperature controller. This must answer the request with a ValueResponse telegram. If the extension does not receive all or some of the answers, the affected objects are initialised with "0". In this case, after a reset the objects must first be actively rewritten by the bus by other bus subscribers, e.g. through automatic transmission by the main controller. This is also always the case when the parameter "Value request from controller extension?" is configured to "No".

The automatic update takes place for all the transmitting objects with the name "B.Controller extension" and additionally for the objects "D.Input controller ext. status signal addition" and "D.Input controller ext. ventilation visualisation".

- i** The automatic update can take place with a delay after a device reset. If there are still other bus devices besides the push button sensor transmitting telegrams immediately after a reset, it may be useful to activate the transmit delay for in order to reduce the bus load (see chapter 4.2.4.1.15. Transmission delay).
- i** During commissioning, all extensions should be put into operation first. Only then should the main controller be connected and programmed. For larger KNX/EIB installations where the extensions are sometimes distributed over several lines, the remaining lines should also be initialized after a reset of one line.

4.2.4.4 Scene function

Scene control

The push button sensor can be used in two different ways as part of a scene control system...

- Each rocker or button can work as a scene extension. This feature makes it possible to recall or to store scenes which may be stored in other devices (see chapter 4.2.4.1.7. Scene extension function).
- The push button can independently store up to eight scenes with eight actuator groups. These internal scenes can be recalled or stored by the rockers or buttons (internal scene recall) and also by the communication object "B. scene extension input". In the following subsections the internal scene function will be dealt with in greater detail.

Scene definition and scene recall

If the internal scenes are to be used, the parameter "Scene function ?" in the parameter node "Scenes" must be set to "Yes".

The matching data types for the eight scene outputs must then be selected and adapted to the actuator groups used. The types "Switching", "Value (0 ... 255)" or "Value / blind position (0 ... 100 %)" can be selected. As a rule, Venetian blinds are controlled via two scene outputs. One output controls the blind height and the other one adjusts the slat position.

There is a separate parameter node available in the ETS for each scene output. The data types can be selected in this node using the parameters of the same name. The ETS sets the corresponding communication objects and the additional parameters of the scene commands.

The scene parameters can be set in the parameter node of a scene output for each individual scene ("scene 1 ... 8"). The setting options are the same for all 8 scenes.

It is possible that the values for the individual scenes preset by the parameters are modified later on with the storage function (see page 163-164) when the system is in operation. If the application program is then loaded again with the ETS, these locally adapted values will normally be overwritten by the parameters. Due to the fact that it may take considerable efforts to readjust the values for all scenes in the system, the parameter "Overwrite scene values during ETS download ?" offers the possibility of retaining the scene values stored in operation without overwriting them.

These internal scenes can be recalled directly via the rockers or buttons (function "Recall internal scene") and also by another bus device via the "B. scene extension input" communication object. This 1 byte communication object supports the evaluation of up to 64 scene numbers. For this reason it must be specified which of the external scene numbers (1 ... 64) is to recall the internal scene (1 ... 8). This specification is made using the parameters "Recall scene 1...8 via extension object with scene number" in the "Scenes" parameter node. If the same scene number is listed for several internal scenes at this point, it is always only the first of these scenes that will be activated (scene with the lowest scene number).

In some situations there may be the requirement that a group of actuators is not controlled by all, but only by certain scenes. A classroom, for instance, may require open blinds for the "Welcome" and "Break" scenes, closed blinds in the "PC presentation" scene and no change in the "Discussion" scene. In this example, the parameter "Permit transmission ?" in the parameter node of a scene output can be set to "No" for the "Discussion" scene. The scene output is then deactivated during the corresponding scene.

The parameter "Transmit delay" permits an individual waiting time for each scene output. This transmit delay can be used in different situations...

- When the actuators participating in a scene transmit status messages automatically or when several scene buttons are used to increase the number of channels within the scenes, the recall of a scene may result for a short time in high bus loading. The transmit delay helps to reduce the bus load at the time of scene recall.
- Sometimes, it is desirable that an action is started only after another action has ended. This can be for instance the illumination which is to shut off only after the blinds/shutters have been raised.

The transmit delay can be set separately for each scene output in the parameter group of a scene. The transmit delay defines the time delay between the individual telegrams during a scene recall. The setting specifies how much time must pass after the first scene telegram before the second is transmitted. After transmission of the second scene telegram, the configured time must again pass before the third is transmitted and so forth... The transmit delay for the scene telegram of the first output starts immediately after the scene has been recalled.

The transmit delay between telegrams can also be deactivated (setting "0"). The telegrams are then transmitted at the shortest possible time interval. In this case, however, the order of the telegrams transmitted can deviate from the numbering of the scene outputs.

- i** When a new scene recall (also with the same scene number) occurs during a current scene recall - even in consideration of the pertaining transmit delays - the scene processing started first will be aborted and the newly received scene number will be processed. A running scene is also aborted when a scene is being stored!
- i** During a scene recall - even if delayed - the control surfaces of the push button sensor are operational.

Storing scenes

For each output of a scene, the user can define a corresponding scene value in the ETS which is then transmitted to the bus during a scene recall. During the ongoing operation of the system it may be necessary to adapt these preset values and to save the adapted values in the push button sensor. This can be ensured by the storage function of the scene control.

The value storage function for the corresponding scene number is enabled with the parameter "Permit storing ?" ("Yes") or disabled ("No"). When the storage function is disabled, the object value of the corresponding output is not sampled during storage.

A scene storage process can be initiated in two different ways...

- by a long press on a rocker or button of a control surface configured as "Scene extension",
- by a storage telegram to the extension object.

During a storage process, the push button sensor reads the current object values of the connected actuators. This is carried out by means of eight read telegrams (ValueRead) addressed to the devices in the scene which return their own value (ValueResponse) as a reaction to the request. The returned values are received by the push button sensor and taken over permanently into the scene memory. Per scene output, the push button sensor waits one second for a response. If no answer is received during this time, the value for this scene output remains unchanged and the push button sensor scans the next output.

In order to enable the push button sensor to read the object value of the actuator addressed when a scene is stored, the read flag of the corresponding actuator object must be set. This





should be done only for one actuator out of an actuator group so that the value response is unequivocal.

The stored values overwrite those programmed into the push button sensor with the ETS.

- i The storage process will always be executed completely by the push button sensor and cannot not be aborted before it has ended.
- i Recalling scenes in the course of a storage process is not possible, the buttons or rockers of the push button sensor remain nevertheless operational.

4.2.4.5 Delivery state

Delivery state and non runnable application

For as long as the device has not yet been programmed with application data by means of the ETS, the operation LED flashes at a slow rate (approx. 0.75 Hz). If the left display button is actuated, the icons  and  and all the 'interior segments of the display light up. In the same way, if the right display button is actuated, the icons  and  and all the 'interior segments of the display light up. If any of the buttons on the push button sensor function section is pressed, the corresponding status LED lights up for the length of the button press.

This condition persists until the application is programmed into the device.

By slow flashing of its operation LED (approx. 0.75 Hz), the device can also indicate that a wrong application has been programmed into its memory. Applications are non run-capable if they are not intended for use with the device in the ETS product database. Attention must also be paid to the fact that the pushbutton sensor variant is compatible with the one in the project (e.g. 3x version created in the ETS project and also installed).

In both cases, the push button sensor and the integrated room temperature controller are not operational.

Unloading of the application program by the ETS completely deactivates the device function. In this case, the device is not reset to the delivery state described above. The buttons and the status LED do not have a function. Only the Operation LED flashes slowly and the display shows "nP".

4.2.4.6 Display

Introduction

On the front side of the device, behind the glass surface, there is an LED display (2) with switchable backlighting (Figure 48). On the display, icons signal various operating states of the integrated room temperature controller or the controller extension. In addition, up to four pieces of display information (time, actual temperature, setpoint temperature, external temperature) can be shown on the display either alternating over time or controlled by a communication object.

To the left and right of the display, there are two sensor areas (1), the display buttons. The display buttons can be used to influence the display and - depending on the controller function configured in the ETS - shift the setpoint temperature or recall the second operating level (see chapter 2.5. Operation).



Figure 48: Device display and display buttons

- (1) Sensor areas on left and right for display operation (display buttons)
- (2) LED display

4.2.4.6.1 Displayed information

Icons

Table 13 clarifies the meaning of all the display icons. The icons signal various states of the integrates room temperature controller or the controller extension and the display operation.

Icon	Meaning
⌋↑	"Comfort" operating mode active. Can flash when setting the operating mode in the second operating level.
↑⌋	"Standby" operating mode active. Can flash when setting the operating mode in the second operating level.
☾	"Night" operating mode active. Can flash when setting the operating mode in the second operating level.
*☼	"Frost/heat protection" operating mode active. Flashes on frost alarm ($T_{\text{Room}} \leq + 5 \text{ °C}$).
⊕	The controller is in dew point operation. The controller is thus disabled.
⌋↑☾	A "Night comfort extension" is active.
⌋↑*☼	A "Frost/heat protection comfort extension" is active.
☞	A basic setpoint shift in the positive or negative direction is active.
*.	Display of a fan controller configured in the ETS (impeller) with display of the active fan level (points) *., *., *.

+☳	The controller uses this icon to signal that heating energy is being fed to the room (Heating command value > 3%). If only "+" is lit, the controller is in heating mode without requesting heating energy. This icon is also visible in the second operating level for setpoint temperature settings for heating operation.
-☾	The controller uses this icon to signal that cooling energy is being fed to the room (Heating command value > 3%). If only "-" is lit, the controller is in cooling mode without requesting cooling energy. This icon is also visible in the second operating level for setpoint temperature settings for cooling operation.
⏻	A button disable is active.
⌋	In the basic display, the room temperature is shown in the display.
⌋⌋	In the basic display, the outdoor temperature is shown in the display.
1...7	Weekday display 1=Mon, 2=Tue, 3=Wed, 4=Thu, 5=Fri, 6=Sat, 7=Sun
-	This icon is active if a value change should be made in the negative direction. It is always displayed together with the "+" icon.
+	This icon is active if a value change should be made in the positive direction. It is always displayed together with the "-" icon.
OK	This icon is active if, in the second operating level, a menu selection is possible using the neighbouring display button. It is always displayed together with the ^ icon.
^	This icon is active if, in the second operating level, menu navigation is possible using the neighbouring display button. It is always displayed together with the "OK" icon.

Table 13: Meaning of the display icons

Display information

In addition to the icons, it is possible to use the numeric display to show up to four display functions in the display. This means that it is possible to indicate the time and day, the setpoint temperature, the actual temperature or the outdoor temperature.

In the ETS, it is possible to configure which of this information is actually shown in the display. Firstly, it is necessary to specify how much display information should be shown. For this, the parameter "Amount of display information" in the "Display" parameter node should be set to the required number (1...4). For each piece of display information, additional parameter nodes are then shown in the ETS. In the parameter nodes of the display information, the parameters "Display information 1...4" can be configured further to specify whether the time and the day, the setpoint temperature, the actual temperature or the outdoor temperature is displayed as information.

The information is shown separately on the display. It is possible to switch between the information automatically after set times or in controlled manner using a communication object (see chapter 4.2.4.6.2. Display control).

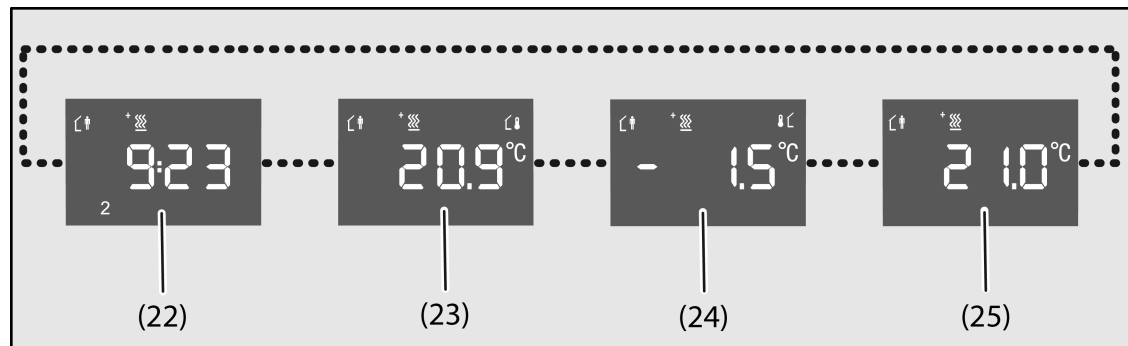

Figure 49: Possible display information of the display

(22) Time and day display

(23) Actual temperature display (lights up together with the icon \downarrow)

(24) External temperature display (lights up together with the icon \downarrow)

(25) Setpoint temperature display

Indication of temperature values

The room temperature reading has a resolution of 0.1 °C and covers a range from -99.9 °C to +99.9 °C. The indication will refresh as soon as the determined room temperature changes within the resolution interval. Should the room temperature reach or go below + 5 °C, the icon \ast also flashes in the display as a temperature alarm.

The outside temperature reading has a resolution of 0.1 °C and also covers a range from -99.9 °C to +99.9 °C. The temperature display will refresh as soon as a temperature value telegram is received via the "Outdoor temperature" object. After a device reset, the display shows "---" until a telegram is received. If configured, the outdoor temperature will only be read on the display and cannot be used for any further temperature or variable calculation in the controller.

The setpoint temperature is indicated as an absolute temperature value. The currently adjusted setpoint temperature of the active operating mode is displayed. The device always rounds the indication to half degrees and shows the rounded-off temperature in the display. Its possible temperature range depends on the configured operating mode and is given by the fixed values for the frost and/or heat protection temperature. The indication will refresh once a new setpoint temperature for the controller results (e. g. from a change of the operating mode or of the basic setpoint, etc.).

Indication of time information

The device possesses an internal clock, set using a communication object. The internal calculation of the current time is primarily influenced by the scope of the internally planned functions and the resulting data traffic. This may cause particularly large time deviations. For this reason, the internal clock should be synchronised on a regular basis. We recommend using, for example, an external KNX/EIB clock with DCF 77 receiver, to set the clock once an hour via the bus and thus keep the deviations as small as possible. The weekday information is provided by the received time signal.

After a device reset, the display shows "--:--" until a time signal is received. The same indication will appear unless the internal clock has been updated via the bus at least once a day (updating check at 4:00 a.m.). In both cases, the time is invalid until the first or a new time telegram is received.

If the time is invalid, an optional automatic time poll can take place. For this, the "Request time" parameter in the "General" parameter node of the ETS can be set to "Yes". In this case, if the time information is invalid, the device will request time once only by sending a read telegram to the bus. The read request should be confirmed by an other bus subscriber using an answer telegram.

The time is always displayed in the 24-hour format.

Special display information

When Programming mode is enabled, the display shows "Pd". If the application program has

been unloaded by the ETS, "nP" is signalled in the display.

4.2.4.6.2 Display control

Backlighting

The function of the display backlighting is specified in the parameter of the same name in the "Display" parameter node. The backlighting can be permanently switched on or off. In addition, it can also be switched according to events.

Possible events with which backlighting can be activated are...

- Actuation of any sensor area,
- The normal or inverted value of a switching telegram via the 1-bit communication object "Backlighting on / off".

If the lighting is switched on by pressing a sensor area, the device switches the lighting off automatically when the switch-off time configured in the ETS elapses. The switch-off time is retriggered by each sensor area operation-

When the backlighting is switched by the communication object, the lighting remains switched on according to the switching value

(not inverted: "0" = OFF / "1" = ON; inverted: "0" = ON / "1" = OFF).

Lighting activation by operating a sensor area can be combined with switching via the object. In this case, lighting is switched on automatically when a sensor area is actuated and switched off against after the switch-off time configured in the ETS has elapsed. In addition, the lighting can also be switched by the communication, independently of operation on the device. In this case, the lighting is no longer switched off automatically when the time has elapsed. The switch-off can then only take place using a switch-off telegram in accordance with the normal or inverted telegram polarity. It is not possible to switch-off backlighting switched on by actuation early using a switching telegram.

Switching over the display

Up to four pieces of display information (time, actual temperature, setpoint temperature, outdoor temperature) can be shown on the display (see chapter 4.2.4.6.1. Displayed information). The individual pieces of information are shown separately in the numeric display. If more than one piece of information is configured in the ETS and is to be displayed, then the display must be switched over during operation.

It is possible to switch between the information automatically after set times or, independently of this, in controlled manner using a communication object...

- **Switchover by time:**
If more than one piece of display information is configured in the ETS, the "Cyclical display function changeover" parameter is visible. At this point, the display time for information can be specified. The next piece of information is displayed when this time has elapsed. When the last piece of information has been reached, there is a changeover to the first piece of information.
For each piece of display information, it is possible to specify whether it is included in the time cycle, i.e. should be recalled automatically. The first piece of information is always included in the changeover. If additional pieces of information are not to be displayed automatically, the "Display X in cyclical changeover" parameter in the Display function parameter node should be set to "No".

- **Switchover by communication object:**
In addition to the changeover by time, the information indication can also be controlled by a communication object. If more than one piece of display information is configured in the ETS, the "Recall display functions" parameter is visible. This parameter can be used to specify the data format of the recall object.
With recall by a switching object, it is possible to define in the ETS which display information should be displayed with object control. In so doing, a telegram value "1" can select one of up to four pieces of information. When recalled using a value object, the received telegram value immediately specifies the display information to be recalled. Any piece of information defined in the ETS can be recalled with a value of "1" to "4". If the opened page is not planned or a value is received, which cannot be assigned to any piece of information, then the telegram is ignored.
Recall of a piece of display information by the object overdrives the display through the time changeover. In both data formats, the value "0" reenables the cyclical information changeover. Information recalled via the object is shown in the display until a "0" is received via the object.

- i** A piece of display information recalled by the communication object is overdriven as soon as the device is operated locally at this time (e.g. setpoint shift, second operating level). At the end of local operation, the display information is shown which was most recently recalled via the object by an object value not equal to "0". If no valid information recall has taken place through the object, then the cyclical changeover takes place at the end of local operation.

- i** When the communication object is used to switch the display information, the reception of a "0" telegram always resets the cycle time of the automatic changeover. The display always jumps back to the first piece of information.

4.2.5 Parameters

4.2.5.1 General parameters

Description	Values	Comment
<input type="checkbox"/> General		
Transmit delay after reset or bus voltage return	Yes No	<p>After a device reset, the device can automatically transmit telegrams for the "Controller extension" function. The controller extension then attempts to retrieve values from the room temperature controller by means of read telegrams in order to update the object states. If there are still other devices installed in the bus which transmit telegrams immediately after a reset, it may be useful here to activate the transmit delay for automatically transmitting objects of the controller extension and the room temperature measurement in order to reduce the bus load.</p> <p>When transmit delay is activated (setting: "Yes"), the device computes the delay time from its device ID in the physical address. There is a maximum delay of 30 seconds before the telegrams are transmitted.</p>
Light period of status LED for button-press display	1 sec 2 sec 3 sec 4 sec 5 sec	This parameter defines the switch-on time the status LED is lit up to indicate actuation. The setting concerns all status LEDs whose function is set to "Button-press display".
Function of operation LED	always OFF always ON Control via object flashing	<p>This parameter defines the function of the operation LED.</p> <p>The operation LED is always off.</p> <p>The operation LED is always on, for instance, as orientation lighting.</p> <p>The operation LED is controlled by a separate communication object.</p> <p>The operation LED flashes permanently with a frequency of about 0.75 Hz.</p> <p>Besides the function set here, the operation LED can display different states by means of other flashing rates. These comprise Programming mode, the confirmation of full-surface actuation or the message that an application has not been loaded.</p>

Control of the operation LED via the object value	1 = LED static ON / 0 = LED static OFF 1 = LED static OFF / 0 = LED static ON 1 = LED flashes / 0 = LED static OFF 1 = LED static OFF / 0 = LED flashes	If the "Function of the operation LED" is set to "Control via object", then the telegram polarity of the 1-bit object "B. Operation LED" can be specified at this point. The LED can be switched on or off statically. In addition, the received switching telegram can be evaluated in such a way that the LED flashes.
Request time	No Yes	The device possesses an internal clock, set using a communication object. The internal calculation of the current time is primarily influenced by the scope of the internally planned functions and the resulting data traffic. This may cause particularly large time deviations. For this reason, the internal clock should be synchronised on a regular basis. The device will consider the internal time invalid for as long as no time telegram is received after a device reset, or if there has been no update for a day. In this case, an optional automatic time poll can take place. For this, the automatic time poll can be activated using the "Yes" setting here. In so doing, if the time information is invalid, the device will request the time once only by sending a read telegram to the bus. The read request should be confirmed by another bus subscriber using an answer telegram.

4.2.5.2 Parameters on the push button sensor function section

Description	Values	Comment
☐↵ Push button sensor ->	Rocker/button selection	
Function of buttons 1 and 2	Rocker function (rocker 1)	The operating concept of the buttons for the push button sensor function can either be configured as a rocker function or alternatively as a button function here. With the rocker function, two neighbouring sensor buttons are assigned an identical function. For the button function, each sensor area is evaluated separately, meaning that different functions can be executed. When two sensors surfaces are combined into one rocker, it is also possible to trigger special functions by a press on the whole surface.
(The same parameters are available for the other sensor areas of the device.)	Button function	

☐↵ Pushbutton sensor -> Rocker/button selection -> Rocker 1 (buttons 1/2) (only if "Function of buttons 1 and 2 = as one rocker (rocker 1)!")

Function	Switching	
	Dimming	This parameter is used to define the basic function of the rocker. Depending on this choice, the ETS displays different communication objects and parameters for this rocker.
	Venetian blind	
	Value transmitter 1-byte	
	2-byte value transmitter	
	Scene extension	
	2-channel operation	

The following parameters are only valid for the rocker function "Switching"...

Command on pressing left rocker	No reaction ON OFF TOGGLE	These parameters specify the reaction when the left rocker is pressed or released.
Command on releasing left rocker	No reaction ON OFF TOGGLE	
Command on pressing right rocker	No reaction ON OFF TOGGLE	These parameters specify the reaction when the right rocker is pressed or released.
Command on releasing right rocker	No reaction ON OFF TOGGLE	

The following parameters are only valid for the rocker function "Dimming"...

Command on pressing left rocker	No reaction Brighter (ON) Darker (OFF) Brighter / darker (TOGGLE) Brighter (TOGGLE) Darker (TOGGLE)	This parameter defines the reaction when the left rocker is pressed. If the push button sensor is to toggle on a brief press, the corresponding switching objects of other sensors with the same function must be linked with one another. In the "Brighter/darker (TOGGLE)" setting, the dimming objects
---------------------------------	---	---

		must be interlinked as well so that the push button sensor can send the correct telegram on the next button-press.
Command on pressing right rocker	No reaction Brighter (ON) Darker (OFF) Brighter / darker (TOGGLE) Brighter (TOGGLE) Darker (TOGGLE)	This parameter defines the reaction when the right rocker is pressed. If the push button sensor is to toggle on a brief press, the corresponding switching objects of other sensors with the same function must be linked with one another. In the "Brighter/darker (TOGGLE)" setting, the dimming objects must be interlinked as well so that the push button sensor can send the correct telegram on the next button-press.
Time between switching and dimming, left rocker (100 ... 50000 x 1 ms)	100 ... 400 ... 50000	This parameter defines how long the left rocker must be pressed for the push button sensor to send a dimming telegram.
Time between switching and dimming, right rocker (100 ... 50000 x 1 ms)	100 ... 400 ... 50000	This parameter defines how long the right rocker must be pressed for the push button sensor to send a dimming telegram.
Advanced parameters	Activated Deactivated	When the advanced parameters are activated, the ETS shows the following parameters.
Advanced parameters activated...		
Increase brightness by	1.5 % 3 % 6 % 12.5 % 25 % 50 % 100 %	This parameter sets the relative dimming level when the brightness is increased. On each button-press, the brightness is changed at maximum by the configured step width. Especially with smaller dimming levels it is advisable for the push button sensor to repeat the dimming telegrams automatically (see "telegram repetition").
Reduce brightness by	1.5 % 3 % 6 % 12.5 % 25 % 50 % 100 %	This parameter sets the relative dimming level when the brightness is reduced. On each button-press, the brightness is changed at maximum by the configured step width. Especially with smaller dimming levels it is advisable for the push button sensor to repeat the dimming telegrams automatically (see "telegram repetition").

Transmit stop telegram?	Yes No	On "Yes" the push button sensor transmits a telegram for stopping the dimming process when the rocker is released. When the push button sensor transmits telegrams for dimming in smaller levels, the stop telegram is generally not needed.
Telegram repeat?	Yes No	This parameter can be used to activate telegram repetition for dimming. With the button held down, the push button sensor will then transmit the relative dimming telegrams (in the programmed step width) until the button is released.
Time between two telegrams	200 ms 300 ms 400 ms 500 ms 750 ms 1 sec 2 s	This parameter defines the interval at which the dimming telegrams are automatically repeated in the telegram repetition mode. Visible only if "Telegram repetition = Yes"!
Full-surface operation	enabled Disabled	When the full-surface operation is enabled, the ETS shows the following parameters.
Function for full-surface operation	Switching Scene recall without store function Scene recall with storage function	In case of full-surface operation, this parameter defines the function that is to be used. The ETS shows the corresponding communication object and the other parameters. If the push button sensor is to recall a scene with storage function by full-surface actuation, it will make a distinction between a brief press (less than 1 s), a sustained press (longer than 5 s) and an invalid button-press (between 1 s and 5 s). A brief press recalls the scene, a sustained press stores a scene and an invalid full-surface operation is ignored. Visible only if "Full-surface operation = enabled"!
Command for full-surface operation	ON OFF TOGGLE	This parameter defines the value of the transmitted telegram when a full-surface operation has been sensed. "TOGGLE" changes over the current object value. Visible only if "Full-surface operation = enabled"!

Scene number (1 ... 64) **1, 2, ..., 64**

This parameter defines the scene number which is to be transmitted to the bus after a scene recall or during storage of a scene.
Visible only if "Full-surface operation = enabled"!

The following parameters are only valid for the rocker function "Venetian blind"...

Command on pressing rocker

**Left rocker: UP /
Right rocker: DOWN**

Left rocker: DOWN /
Right rocker: UP

Left rocker: TOGGLE /
Right rocker: TOGGLE

This parameter defines the running direction of a drive after a button-press. If the setting is "TOGGLE", the direction is changed after each long time command. If several push buttons are to control the same drive, the long time objects of the push buttons must be interlinked for a correct change of the running direction.

Operation concept

short – long – short

long – short

short – long

long – short or short

For Venetian blind control, four different operation concepts can be selected. For these concepts, the ETS shows further parameters.

Time between short and long time command, left rocker
(1 ... 3000 x 100 ms)

1 ... **4** ... 3000

This parameter sets the time after which the long-time operation will be evaluated on pressing the left button of the rocker. This parameter is not visible with "Operation concept = long – short"!

Time between short and long time command, right rocker
(1 ... 3000 x 100 ms)

1 ... **4** ... 3000

This parameter sets the time after which the long-time operation will be evaluated on pressing the right button of the rocker. This parameter is not visible with "Operation concept = long – short"!

Slat adjusting time, left rocker
(0 ... 3000 x 100 ms)

0 ... **5** ... 3000

Time during which a transmitted long time telegram can be terminated by releasing the left button of the rocker (short time). This function serves to adjust the slats of a blind. This parameter is not visible with "Operation concept = long – short"!

Slat adjusting time, right rocker
(0 ... 3000 x 100 ms)

0 ... **5** ... 3000

Time during which a transmitted long time telegram can be terminated by releasing the right button of the rocker (short time). This function serves to adjust the slats of a blind.

		This parameter is not visible with "Operation concept = long – short"!
Full-surface operation	enabled Disabled	When the full-surface operation is enabled, the ETS shows the following parameters. Full-surface operation can only be programmed if "Operation concept = long – short or short"!
Function for full-surface operation	Switching Scene recall without store function Scene recall with storage function	In case of full-surface operation, this parameter defines the function that is to be used. The ETS shows the corresponding communication object and the other parameters. If the push button sensor is to recall a scene with storage function by full-surface actuation, it will make a distinction between a brief press (less than 1 s), a sustained press (longer than 5 s) and an invalid button-press (between 1 s and 5 s). A brief press recalls the scene, a sustained press stores a scene and an invalid full-surface operation is ignored. Visible only if "Full-surface operation = enabled"!
Command for full-surface operation	ON OFF TOGGLE	This parameter defines the value of the transmitted telegram when a full-surface operation has been sensed. "TOGGLE" changes over the current object value. Visible only if "Full-surface operation = enabled"!
Scene number (1 ... 64)	1, 2, ..., 64	This parameter defines the scene number which is to be transmitted to the bus after a scene recall or during storage of a scene. Visible only if "Full-surface operation = enabled"!

The following parameters are only valid for the rocker function "Value transmitter 1-byte"...

Function	Left rocker / right, no function Left rocker: 0 ... 255 / Right rocker: 0 ... 255 Left rocker: 0 ... 100 % / Right rocker: 0 ... 100 % Left rocker: 0 ... 255 / Right rocker: No function	A rocker configured as "Value transmitter 1 byte" permits selecting whether the values to be transmitted are interpreted as integers from 0 to 255 or as a percentage from 0 % to 100 %. The following parameters and their settings depend on this distinction.
----------	--	--

	Left rocker: 0 ... 100 % / Right rocker: No function	
	Left rocker: No function / right rocker: 0 ... 255	
	Left rocker: No function / right rocker: 0 ... 100 %	
Value, left rocker (0 ... 255)	0 ... 255	This parameter defines the object value when the left rocker is pressed. Visible only if "Function = ... 0...255"!
Value, right rocker (0 ... 255)	0 ... 255	This parameter defines the object value when the right rocker is pressed. Visible only if "Function = ... 0...255"!
Value, left rocker (0 ... 100 %)	0 ... 100	This parameter defines the object value when the left rocker is pressed. Visible only if "Function = ... 0...100 %"!
Value, right rocker (0 ... 100 %)	0 ... 100	This parameter defines the object value when the right rocker is pressed. Visible only if "Function = ... 0...100 %"!
Value adjustment by long button-press	enabled Disabled	If value adjustment by long button-press is enabled, the ETS shows further parameters. Value adjustment begins, when the button is held down for more than 5 s. In this case, the respective status LED flashes as a sign that a new telegram has been transmitted.
Starting value in case of value adjustment	Same as configured value Same as value after last adjustment Same as value from communication object	Value adjustment can begin with different starting values. After each long press, the pushbutton sensor always starts with the value configured in the ETS. After a long press, the pushbutton sensor starts with the value transmitted by itself or by another device with this group address as the last value. After a long press, the pushbutton sensor starts with the value transmitted by itself or by another device with this group address as the last value. Visible only if "Value adjustment by long button-press = enabled"!

Direction of value adjustment	Upwards	With a long press, the push button sensor can either vary the values always in the same direction or it stores the direction of the last adjustment and reverses it on the next button-press. Visible only if "Value adjustment by long button-press = enabled"!
	Downwards	
	Toggling (alternating)	
Step width (1 ... 15)	1 ... 15	In a value adjustment, the pushbutton sensor determines the new telegram value from the previous value and the preset step width. If the value falls below the lower limit of the adjustment range (0 or 0 %) or if it exceeds the upper limit (255 or 100%), the sensor adapts the step width of the last step automatically. Visible only if "Value adjustment by long button-press = enabled"!
Time between two telegrams	0.5 sec	In a value adjustment, the pushbutton sensor determines the new telegram value from the previous value and the preset step width. If the value falls below the lower limit of the adjustment range (0 or 0 %) or if it exceeds the upper limit (255 or 100%), the sensor adapts the step width of the last step automatically. Visible only if "Value adjustment by long button-press = enabled"!
	1 sec	
	2 sec	
	3 sec	
Value adjustment with overflow	Yes	If value adjustment is to be effected without overflow (setting "No") and if the pushbutton sensor reaches the lower limit of the adjustment range (0 or 0 %) or the upper limit (255 or 100 %) during value adjustment, the adjustment will be stopped automatically by the sensor. If the value adjustment with overflow is programmed (setting "Yes") and if the push button sensor reaches the lower or the upper limit, it will transmit the value of this range limit and then add a pause the duration of which corresponds to two levels. Thereafter, the push button sensor transmits a telegram with the value of the other range limit and continues the value adjustment in the same direction.
	No	

The following parameters are only valid for the rocker function "Value transmitter 2-byte"...

Function	Temperature value transmitter	A rocker configured as "Value transmitter 1 byte" permits selecting whether the values to be transmitted are
----------	--------------------------------------	--

	Brightness value transmitter		to be interpreted as temperature values (0 °C to 40 °C), as brightness values (0 lux to 1500 lux) or as integers (0 to 65535). The following parameters and their settings depend on this selection.
	Value transmitter (0 ... 65535)		
Temperature value (0 ... 40 °C) Left rocker	0 ... 20 ... 40		This parameter defines the object value when the left rocker is pressed. Visible only if "Function = Temperature value transmitter"!
Temperature value (0 ... 40 °C) Right rocker	0 ... 20 ... 40		This parameter defines the object value when the right rocker is pressed. Visible only if "Function = Temperature value transmitter"!
Brightness value Left rocker	0, 50, ... 300 ... 1450, 1500 lux		This parameter defines the object value when the left rocker is pressed. Visible only if "Function = Brightness value transmitter"!
Brightness value Right rocker	0, 50, ... 300 ... 1450, 1500 lux		This parameter defines the object value when the right rocker is pressed. Visible only if "Function = Brightness value transmitter"!
Value (0 ... 65535) Left rocker	0 ... 65535		This parameter defines the object value when the left rocker is pressed. Visible only with "Function = Value transmitter (0 ... 65535)"!
Value (0 ... 65535) Right rocker	0 ... 65535		This parameter defines the object value when the right rocker is pressed. Visible only with "Function = Value transmitter (0 ... 65535)"!
Value adjustment by long button-press	enabled Disabled		If value adjustment by long button-press is enabled, the ETS shows further parameters. Value adjustment begins, when the button is held down for more than 5 s. In this case, the respective status LED flashes as a sign that a new telegram has been transmitted.
Starting value in case of value adjustment			Value adjustment can begin with different starting values.
	Same as configured value		

		After each long press, the pushbutton sensor always starts with the value configured in the ETS.
	Same as value after last adjustment	After a long press, the pushbutton sensor starts with the value transmitted by itself or by another device with this group address as the last value.
	Same as value from communication object	After a long press, the pushbutton sensor starts with the value transmitted by itself or by another device with this group address as the last value. This setting selectable only if "Function = Value transmitter (0...65535)"! Visible only if "Value adjustment by long button-press = enabled"!
Direction of value adjustment	Upwards	With a long press, the push button sensor can either vary the values always in the same direction or it stores the direction of the last adjustment and reverses it on the next button-press. Visible only if "Value adjustment by long button-press = enabled"!
	Downwards	
	Toggleing (alternating)	
Step width	1 °C	For temperature values, the step width of the adjustment is fixed to 1°C. Visible only if "Function = Temperature value transmitter" and "Value adjustment by long button-press = enabled"!
Step width	50 lux	For brightness values, the step width of the adjustment is fixed to 50 lux. Visible only if "Function = Brightness value transmitter" and "Value adjustment by long button-press = enabled"!
Step width	1 2 5 10 20 50 75 100 200 500 750 1000	This parameter sets the step width of the value adjustment for the 2-byte value transmitter. Visible only if "Function = Temperature value transmitter" and "Value adjustment by long button-press = enabled"!
Time between two telegrams	0.5 sec 1 sec	This parameter defines the interval at which the push button sensor transmits new telegrams during a value

	2 sec 3 sec	adjustment. Visible only if "Value adjustment by long button-press = enabled"!
Value adjustment with overflow	Yes No	If value adjustment is to be effected without overflow (setting "No") and if the pushbutton sensor reaches the lower limit of the adjustment range (0°C, 0 lux, 0) or the upper limit (40°C, 1500 lux, 65535) during value adjustment, the adjustment will be stopped automatically by the sensor. If the value adjustment with overflow is programmed (setting "Yes") and if the push-button sensor reaches the lower or the upper limit, it will transmit the value of this range limit and then add a pause the duration of which corresponds to two levels. Thereafter, the push button sensor transmits a telegram with the value of the other range limits and continues the value adjustment in the same direction.

The following parameters are only valid for the rocker function "Scene extension"...

Function	Scene extension without storage function	This parameter defines the functionality of the extension. If the push button sensor is used as a scene extension, the scenes can either be stored in one or in several other KNX/EIB devices (e.g. light scene push button sensor). During a scene recall or in a storage function, the push button sensor transmits a telegram with the respective scene number via the extension object of the rocker. During the recall of an internal scene, a scene stored internally in the device is recalled or stored again. In this case, the sensor transmits no telegram to the bus via a scene extension object. For this setting, the internal scene function must be enabled.
	Scene extension with storage function	
	Recall of internal scene extension without storage function	
	Recall of internal scene with storage function	
Scene number (1 ... 64) Left rocker	1 ... 64	In accordance with the KNX standard, objects with data type 18.001 "Scene Control" can recall or store up to 64 scenes by their numbers. The parameter defines the scene number to be transmitted when a left button is pressed.
Scene number (1 ... 64) Right rocker	1 ... 64	In accordance with the KNX standard, objects with data type 18.001 "Scene Control" can recall or store up to 64

scenes by their numbers. The parameter defines the scene number to be transmitted when a right button is pressed.

Scene number (1 ... 8)
Left rocker

This parameter defines the number of the internal scene which is recalled or stored when a left button is pressed.

Scene number (1 ... 8)
Right rocker

This parameter defines the number of the internal scene which is recalled or stored when a right button is pressed.

The following parameters are only valid for the rocker function "2-channel operation"...

Operation concept **Channel 1 or channel 2**
Channel 1 and channel 2

This parameter defines the 2-channel operation concept. If the setting "Channel 1 or channel 2" is selected, the push button sensor decides dependent on the button-press duration which of the channels will be used. If the setting "Channel 1 and channel 2" is selected, the push button sensor transmits only the telegram of channel 1 on a short button-press and both telegrams on a sustained button-press.

Function channel 1 (2) No function
Switching (1 bit)
Value transmitter 0 ... 255 (1-byte)
Value transmitter 0 ... 100 % (1-byte)
Temperature value transmitter (2 bytes)

This parameter defines the channel function and specifies which other parameters and which communication object are to be displayed for channel 1 (2).

Command of button for channel 1 (2)
Left rocker **ON**
OFF
TOGGLE

This parameter defines the object value transmitted to the bus, when the left-hand rocker is pressed. Only visible if "Function channel 1 (2) = Switching (1 bit)"!

Command of button for channel 1 (2)
Right rocker **ON**
OFF
TOGGLE

This parameter defines the object value transmitted to the bus, when the right-hand rocker is pressed. Only visible if "Function channel 1 (2) = Switching (1 bit)"!

Value of the button for Channel 1 (2)
Left rocker (0...255) **0 ... 255**

This parameter defines the object value transmitted to the bus, when the left-hand rocker is pressed. Visible only if "Function channel 1 (2) = value transmitter 0...255 (1 byte)"!

Value of the button for Channel 1 (2) Right rocker (0...255)	0 ... 255	This parameter defines the object value transmitted to the bus, when the right-hand rocker is pressed. Visible only if "Function channel 1 (2) = value transmitter 0...255 (1 byte)"!
Value of the button for Channel 1 (2) Left rocker (0 ... 100 %)	0 ... 100	This parameter defines the object value transmitted to the bus, when the left-hand rocker is pressed. Visible only if "Function channel 1 (2) = value transmitter 0...100 % (1 byte)"!
Value of the button for Channel 1 (2) Right rocker (0 ... 100 %)	0 ... 100	This parameter defines the object value transmitted to the bus, when the right-hand rocker is pressed. Visible only if "Function channel 1 (2) = value transmitter 0...100 % (1 byte)"!
Temperature value of the button for channel 1 (2) Left rocker (0 ... 40 °C)	0 ... 40	This parameter defines the temperature value transmitted to the bus when the left-hand rocker is pressed. Visible only if "Function channel 1 (2) = Temperature value transmitter (2 bytes)"!
Temperature value of the button for channel 1 (2) Right rocker (0 ... 40 °C)	0 ... 40	This parameter defines the temperature value transmitted to the bus when the right-hand rocker is pressed. Visible only if "Function channel 1 (2) = Temperature value transmitter (2 bytes)"!
Time between channel 1 and channel 2 Left rocker (1 ... 255 x 100 ms)	0 ... 30 ... 255	Depending on the selected operation concept, this parameter defines the interval at which the push button transmits the telegram for channel 1 and the telegram for channel 2 when the left side of the rocker is pressed.
Time between channel 1 and channel 2 Right rocker (1 ... 255 x 100 ms)	0 ... 30 ... 255	Depending on the selected operation concept, this parameter defines the interval at which the push button transmits the telegram for channel 1 and the telegram for channel 2 when the right side of the rocker is pressed.
Full-surface operation	enabled Disabled	When the full-surface operation is enabled, the ETS shows the following parameters.

		Full-surface operation can only be programmed if "Operation concept = Channel 1 or channel 2"!
Function for full-surface operation	<p>Switching</p> <p>Scene recall without store function</p> <p>Scene recall with storage function</p>	<p>In case of full-surface operation, this parameter defines the function that is to be used. The ETS shows the corresponding communication object and the other parameters.</p> <p>If the push button sensor is to recall a scene with storage function by full-surface actuation, it will make a distinction between a brief press (less than 1 s), a sustained press (longer than 5 s) and an invalid button-press (between 1 s and 5 s). A brief press recalls the scene, a sustained press stores a scene and an invalid full-surface operation is ignored.</p> <p>Visible only if "Full-surface operation = enabled"!</p>
Command for full-surface operation	<p>ON</p> <p>OFF</p> <p>TOGGLE</p>	<p>This parameter defines the value of the transmitted telegram when a full-surface operation has been sensed. "TOGGLE" changes over the current object value.</p> <p>Visible only if "Full-surface operation = enabled"!</p>
Scene number (1 ... 64)	1, 2, ..., 64	<p>This parameter defines the scene number which is to be transmitted to the bus after a scene recall or during storage of a scene.</p> <p>Visible only if "Full-surface operation = enabled"!</p>
<p><input type="checkbox"/> Pushbutton sensor -> Rocker/button selection -> Rockers 2 ... n, see rocker 1!</p> <p><input type="checkbox"/> Pushbutton sensor -> Rocker/button selection -> Button 1 (only if "Function of buttons 1 and 2 = as separate buttons"!)</p>		
Function	<p>No function</p> <p>Switching</p> <p>Dimming</p> <p>Venetian blind</p> <p>Value transmitter 1-byte</p> <p>2-byte value transmitter</p> <p>Scene extension</p> <p>2-channel operation</p> <p>Controller extension *</p> <p>Fan controller</p> <p>Controller operating mode</p> <p>Setpoint shift</p> <p>*: Must be enabled under "Room temperature control".</p>	<p>This parameter defines the basic function of the button.</p> <p>Depending on this setting, the ETS displays different communication objects and parameters for this button.</p>

The following parameters are only valid for the push button function "Switching"...

Command on pressing the button	No reaction ON OFF TOGGLE	These parameters specify the reaction when the button is pressed or released.
Command on releasing the button	No reaction ON OFF TOGGLE	

The following parameters are only valid for the push button function "Dimming"...

Command on pressing the button	No reaction Brighter (ON) Darker (OFF) Brighter / darker (TOGGLE) Brighter (TOGGLE) Darker (TOGGLE)	This parameter defines the reaction when the button is pressed. If the push button sensor is to toggle on a brief press, the corresponding switching objects of other sensors with the same function must be linked with one another. In the "Brighter/darker (TOGGLE)" setting, the dimming objects must be interlinked as well so that the push button sensor can send the correct telegram on the next button-press.
Time between switching and dimming (100 ... 50000 x 1 ms)	100 ... 400 ... 50000	This parameter defines how long the button must be pressed for the push button sensor to transmit a dimming telegram.
Advanced parameters	Activated Deactivated	When the advanced parameters are activated, the ETS shows the following parameters.
Advanced parameters activated...		
Increase brightness by	1.5 % 3 % 6 % 12.5 % 25 % 50 % 100 %	This parameter sets the relative dimming level when the brightness is increased. On each button-press, the brightness is changed at maximum by the configured step width. Especially with smaller dimming levels it is advisable for the push button sensor to repeat the dimming telegrams automatically (see "telegram repetition").
Reduce brightness by	1.5 % 3 % 6 % 12.5 % 25 % 50 % 100 %	This parameter sets the relative dimming level when the brightness is reduced. On each button-press, the brightness is changed at maximum by the configured step width. Especially with smaller dimming levels it is advisable for the push button sensor to repeat the dimming telegrams automatically (see "telegram repetition").

Transmit stop telegram?	Yes No	On "Yes" the push button sensor transmits a telegram for stopping the dimming process when the rocker is released. When the push button sensor transmits telegrams for dimming in smaller levels, the stop telegram is generally not needed.
Telegram repeat?	Yes No	This parameter can be used to activate telegram repetition for dimming. With the button held down, the push button sensor will then transmit the relative dimming telegrams (in the programmed step width) until the button is released.
Time between two telegrams	200 ms 300 ms 400 ms 500 ms 750 ms 1 sec 2 s	This parameter defines the interval at which the dimming telegrams are automatically repeated in the telegram repetition mode. Visible only if "Telegram repetition = Yes"!
The following parameters are only valid for the push button function "Venetian blind"...		
Command on pressing the button	DOWN UP TOGGLE	This parameter defines the running direction of a drive after a button-press. If the setting is "TOGGLE", the direction is changed after each long time command. If several push buttons are to control the same drive, the long time objects of the push buttons must be interlinked for a correct change of the running direction.
Operation concept	short – long – short long – short short – long long – short or short	For Venetian blind control, four different operation concepts can be selected. For these concepts, the ETS shows further parameters.
Time between short-time and long-time command (1 ... 3000 x 100 ms)	1 ... 4 ... 3000	This parameter sets the time after which the long-time operation will be evaluated on pressing the button. This parameter is not visible with "Operation concept = long – short"!
Slat adjusting time (0 ... 3000 x 100 ms)	0 ... 5 ... 3000	Time during which a transmitted MOVE telegram can be terminated by releasing

the key (STEP). This function serves to adjust the slats of a blind.
This parameter is not visible with "Operation concept = long – short"!

The following parameters are only valid for the push button function "value transmitter 1 byte"...

Function	Value transmitter 0 ... 255 Value transmitter 0 ... 100 %	A button configured as "Value transmitter 1 byte" permits selecting whether the values to be transmitted are interpreted as integers from 0 to 255 or as a percentage from 0 % to 100 %. The following parameters and their settings depend on this distinction.
Value (0 ... 255)	0 ... 255	This parameter defines the object value when the button is pressed. Visible only if "Function = ... 0...255"!
Value (0 ... 100 %)	0 ... 100	This parameter defines the object value when the button is pressed. Visible only if "Function = ... 0...100 %"!
Value adjustment by long button-press	enabled Disabled	If value adjustment by long button-press is enabled, the ETS shows further parameters. Value adjustment begins, when the button is held down for more than 5 s. In this case, the respective status LED flashes as a sign that a new telegram has been transmitted.
Starting value in case of value adjustment		Value adjustment can begin with different starting values.
	Same as configured value	After each long press, the pushbutton sensor always starts with the value configured in the ETS.
	Same as value after last adjustment	After a long press, the pushbutton sensor starts with the value transmitted by itself or by another device with this group address as the last value.
	Same as value from communication object	After a long press, the pushbutton sensor starts with the value transmitted by itself or by another device with this group address as the last value. Visible only if "Value adjustment by long button-press = enabled"!
Direction of value adjustment	Upwards	With a long press, the push button sensor can either vary the values always in the same direction or it stores the
	Downwards	

	Toggling (alternating)	direction of the last adjustment and reverses it on the next button-press. Visible only if "Value adjustment by long button-press = enabled"!
Step width (1 ... 15)	1 ... 15	In a value adjustment, the pushbutton sensor determines the new telegram value from the previous value and the preset step width. If the value falls below the lower limit of the adjustment range (0 or 0 %) or if it exceeds the upper limit (255 or 100%), the sensor adapts the step width of the last step automatically. Visible only if "Value adjustment by long button-press = enabled"!
Time between two telegrams	0.5 sec 1 sec 2 sec 3 sec	In a value adjustment, the pushbutton sensor determines the new telegram value from the previous value and the preset step width. If the value falls below the lower limit of the adjustment range (0 or 0 %) or if it exceeds the upper limit (255 or 100%), the sensor adapts the step width of the last step automatically. Visible only if "Value adjustment by long button-press = enabled"!
Value adjustment with overflow	Yes No	If value adjustment is to be effected without overflow (setting "No") and if the pushbutton sensor reaches the lower limit of the adjustment range (0 or 0 %) or the upper limit (255 or 100 %) during value adjustment, the adjustment will be stopped automatically by the sensor. If the value adjustment with overflow is programmed (setting "Yes") and if the push button sensor reaches the lower or the upper limit, it will transmit the value of this range limit and then add a pause the duration of which corresponds to two levels. Thereafter, the push button sensor transmits a telegram with the value of the other range limit and continues the value adjustment in the same direction.

The following parameters are only valid for the push button function "value transmitter 2 byte"...

Function	Temperature value transmitter	A button configured as "Value transmitter 1 byte" permits selecting whether the values to be transmitted are to be interpreted as temperature values (0 °C to 40 °C), as brightness values (0 lux to 1500 lux) or as integers (0 to 65535). The following parameters and their settings depend on this selection.
	Brightness value transmitter	
	Value transmitter (0 ... 65535)	

Temperature value (0 ... 40 °C)	0 ... 20 ... 40	This parameter defines the object value when the button is pressed. Visible only if "Function = Temperature value transmitter"!
Brightness value	0, 50, ... 300 ... 1450, 1500 lux	This parameter defines the object value when the button is pressed. Visible only if "Function = Brightness value transmitter"!
Value (0 ... 65535)	0 ... 65535	This parameter defines the object value when the button is pressed. Visible only with "Function = Value transmitter (0 ... 65535)"!
Value adjustment by long button-press	enabled Disabled	If value adjustment by long button-press is enabled, the ETS shows further parameters. Value adjustment begins, when the button is held down for more than 5 s. In this case, the respective status LED flashes as a sign that a new telegram has been transmitted.
Starting value in case of value adjustment	Same as configured value	Value adjustment can begin with different starting values. After each long press, the pushbutton sensor always starts with the value configured in the ETS.
	Same as value after last adjustment	After a long press, the pushbutton sensor starts with the value transmitted by itself or by another device with this group address as the last value.
	Same as value from communication object	After a long press, the pushbutton sensor starts with the value transmitted by itself or by another device with this group address as the last value. This setting selectable only if "Functionality = Value transmitter (0...65535)"! Visible only if "Value adjustment by long button-press = enabled"!
Direction of value adjustment	Upwards Downwards Toggling (alternating)	With a long press, the push button sensor can either vary the values always in the same direction or it stores the direction of the last adjustment and reverses it on the next button-press. Visible only if "Value adjustment by long button-press = enabled"!

Step width	1 °C	For temperature values, the step width of the adjustment is fixed to 1°C. Visible only if "Function = Temperature value transmitter" and "Value adjustment by long button-press = enabled"!
Step width	50 lux	For brightness values, the step width of the adjustment is fixed to 50 lux. Visible only if "Function = Brightness value transmitter" and "Value adjustment by long button-press = enabled"!
Step width	1 2 5 10 20 50 75 100 200 500 750 1000	This parameter sets the step width of the value adjustment for the 2-byte value transmitter. Visible only if "Function = Temperature value transmitter" and "Value adjustment by long button-press = enabled"!
Time between two telegrams	0.5 sec 1 sec 2 sec 3 sec	This parameter defines the interval at which the push button sensor transmits new telegrams during a value adjustment. Visible only if "Value adjustment by long button-press = enabled"!
Value adjustment with overflow	Yes No	If value adjustment is to be effected without overflow (setting "No") and if the pushbutton sensor reaches the lower limit of the adjustment range (0°C, 0 lux, 0) or the upper limit (40°C, 1500 lux, 65535) during value adjustment, the adjustment will be stopped automatically by the sensor. If the value adjustment with overflow is programmed (setting "Yes") and if the push-button sensor reaches the lower or the upper limit, it will transmit the value of this range limit and then add a pause the duration of which corresponds to two levels. Thereafter, the push button sensor transmits a telegram with the value of the other range limits and continues the value adjustment in the same direction.

The following parameters are only valid for the push button function "scene extension"...

Function	<p>Scene extension without storage function</p> <p>Scene extension with storage function</p> <p>Recall of internal scene extension without storage function</p> <p>Recall of internal scene with storage function</p>	<p>This parameter defines the functionality of the extension.</p> <p>If the push button sensor is used as a scene extension, the scenes can either be stored in one or in several other KNX/EIB devices (e.g. light scene push button sensor). During a scene recall or in a storage function, the push button sensor transmits a telegram with the respective scene number via the extension object of the button.</p> <p>During the recall of an internal scene, a scene stored internally in the device is recalled or stored again. In this case, the sensor transmits no telegram to the bus via a scene extension object. For this setting, the internal scene function must be enabled.</p>
Scene number (1 ... 64)	1 ... 64	<p>In accordance with the KNX standard, objects with data type 18.001 "Scene Control" can recall or store up to 64 scenes by their numbers. The parameter defines the scene number to be transmitted when the button is pressed.</p>
Scene number (1 ... 8)	1 ... 8	<p>This parameter defines the number of the internal scene which is recalled or stored when a button is pressed.</p>

The following parameters are only valid for the push button function "2-channel operation"...

Operation concept	<p>Channel 1 or channel 2</p> <p>Channel 1 and channel 2</p>	<p>This parameter defines the 2-channel operation concept. If the setting "Channel 1 or channel 2" is selected, the push button sensor decides dependent on the button-press duration which of the channels will be used.</p> <p>If the setting "Channel 1 and channel 2" is selected, the push button sensor transmits only the telegram of channel 1 on a short button-press and both telegrams on a sustained button-press.</p>
Function channel 1 (2)	<p>No function</p> <p>Switching (1 bit)</p> <p>Value transmitter 0 ... 255 (1-byte)</p> <p>Value transmitter 0 ... 100 % (1-byte)</p>	<p>This parameter defines the channel function and specifies which other parameters and which communication object are to be displayed for channel 1 (2).</p>

Command of button for channel 1 (2)	Temperature value transmitter (2 bytes) ON OFF TOGGLE	This parameter defines the object value transmitted to the bus when the button is pressed. Only visible if "Function channel 1 (2) = Switching (1 bit)"!
Value of the button for Channel 1 (2) (0 ... 255)	0 ... 255	This parameter defines the object value transmitted to the bus when the button is pressed. Visible only if "Function channel 1 (2) = value transmitter 0...255 (1 byte)"!
Value of the button for Channel 1 (2) (0 ... 100 %)	0...100	This parameter defines the object value transmitted to the bus when the button is pressed. Visible only if "Function channel 1 (2) = value transmitter 0...100 % (1 byte)"!
Temperature value of the button for channel 1 (2) (0 ... 40 °C)	0 ... 40	This parameter defines the temperature value transmitted to the bus when the button is pressed. Visible only if "Function channel 1 (2) = Temperature value transmitter (2 bytes)"!
Time between channel 1 and channel 2 (1 ... 255 x 100 ms)	0...30 ... 255	Depending on the selected operation concept, this parameter defines the interval at which the push button transmits the telegram for channel 1 and the telegram for channel 2 when the button is pressed.

The following parameters are only valid for the push button function "Controller extension"...

Function	Operating mode switch-over Forced oper. mode switchover Presence button Setpoint shift	A controller extension can optionally switch over the operating mode with normal or high priority, change the presence state or change the current room temperature value. With regard to the setting of this parameter, the ETS shows further parameters. The "Controller extension" push-button function is only active when the controller extension is activated on the "Room temperature control" parameter page.
Operating mode when the following button is pressed	Comfort mode Standby mode	If the controller extension is to change over the operating mode of the room temperature controller with normal priority, the extension can – when

	Night mode	operated – either switch on a defined operating mode or change over between different operating modes.	
	Frost/heat protection mode		
	Comfort mode -> Standby mode ->	In order for this change to work properly, the controller extension should request the current state of the extension objects after a reset or after re-programming (set parameter of the controller extension under "Room temperature control" to "Value request from controller extension? = Yes").	
	Comfort mode -> Night mode ->	Only visible if "Function = operating mode change-over"!	
	Standby mode -> Night mode ->		
	Comfort mode -> Standby mode -> Night mode ->		
Forced operating mode when the following button is pressed	Auto (Normal operating mode change-over)	If the controller extension is to change over the operating mode of the room temperature controller with high priority, the extension can – when actuated – either enable the change-over with normal priority (auto), switch on a defined operating mode with a high priority or change over between different operating modes.	
	Comfort mode		
	Standby mode		
	Night mode		
	Frost/heat protection mode	In order for this change to work properly, the controller extension should request the current state of the extension objects after a reset or after re-programming (set parameter of the controller extension under "Room temperature control" to "Value request from controller extension? = Yes").	
	Comfort mode -> Standby mode ->	Only visible if "Function = Forced operating mode change-over"!	
	Comfort mode -> Night mode ->		
	Standby mode -> Night mode ->		
	Comfort mode -> Standby mode -> Night mode ->		
	Auto -> Comfort mode ->		
	Auto -> Standby mode ->		
	Presence function when the following button is pressed	Presence OFF	On pressing a key, the controller extension can switch the presence state of the room temperature controller either on or off in a defined way or change over between both states ("Presence TOGGLE").
Presence ON			
Presence TOGGLE		In order for this change-over to work properly, the controller extension should request the current state of the extension objects after a reset or after re-programming (set parameter of the controller extension under "Room	

temperature control" to "Value request from controller extension? = Yes").

With the "Setpoint shift" function"...

Setpoint shift on pressing the button

Reduce setpoint value (level size)

Increase setpoint (level size)

This parameter defines the direction of the setpoint shift on the extension. For a setpoint value shift, the controller extension makes use of the two communication objects "Setpoint shift output" and "Setpoint shift input". The "Setpoint shift input" communication object informs the extension about the current state of the room temperature controller. Based on this value and the respective parameter, the controller extension determines the new level size which it transmits via the "Setpoint shift output" communication object to the room temperature controller.

The following parameters are only valid for the pushbutton function "Fan control"...

Button function

The fan controller distinguishes between automatic and manual operation. The change-over between the two operating modes takes place using the 1-bit object "Ventilation, auto/manual" or through the operation of a button on the device configured for "Fan control".

No function

The button is deactivated. It is not possible to influence the fan operating mode by pressing a button.

Automatic mode

Pressing a button with this setting deactivates manual operation and causes the controller to change over to automatic fan control. Should automatic mode already be active when the button is pressed, then the device will not show any new reaction to the actuation.

Manual control

When a button with this setting is pressed, the controller determines whether it is in automatic or manual operation at the time the button is pressed. If the controller is in automatic mode, then pressing a button switches to manual mode. If, at the time the button is pressed, the manual controller is already active, then the controller switches to the next highest fan level without a delay. If the fan is in the highest level, then pressing a button switches it back to the OFF level. From there, every additional button-press causes the fan level to be raised.

The following parameters are only valid for the pushbutton function "Controller operating mode"...

Button function	No function	The "Controller operating mode" push-button function can be used to control the internal room temperature controller. If this push-button function is used, it is possible to change over the operating mode by pressing the button. In the controller operating mode, a distinction is made between two functions, specified by this parameter. On the one hand, the operating mode (Comfort, Standby, Night, Frost/heat protection) can be changed over and influenced ("Operating mode change-over" setting). On the other hand it is possible to activate the Presence function ("Presence button" setting). The Presence function allows activation of Comfort mode or a comfort extension on the internal controller.
	Operating mode switch-over	
	Presence button	

Operating mode button actuation	Comfort mode	Here, there is a specification of which operating mode is activated when a button is pressed. It is possible to change over between various operating modes. Only visible if "Button function = Operating mode change-over".
	Standby mode	
	Night operation	
	Frost/heat protection mode	
	Comfort mode -> Standby mode	
	Comfort mode -> Night operation	
	Standby mode -> Night operation	
	Comfort mode -> Standby mode -> Night operation	

Presence button actuation	Presence OFF	Pressing the button can either switch the presence status of the room temperature controller on or off or toggle it. Only visible if "button function = presence button"
	Presence ON	
	Presence TOGGLE	

The following parameters are only valid for the pushbutton function "Setpoint shift"...

Button Actuation	No function	The "Setpoint shift" push-button function can be used to control the internal room temperature controller. If this push-button function is used, it is possible to shift the basic setpoint temperature of the controller in a positive direction
	Reduce setpoint	
	Increase setpoint	

("Increase setpoint" setting) or in a negative direction ("Reduce setpoint" setting) by pressing the button.

☐ Pushbutton sensor -> Rocker/button selection -> Buttons 2 ... n, see button 1!

The following parameters are valid for the status LED of the buttons or rockers...

Function of status LED	always OFF	Irrespective of the pushbutton or rocker function, the status LED is switched off permanently.
(With the rocker function, the parameters for the left and right status LED are separate and configurable).		
	always ON	Irrespective of the pushbutton or rocker function, the status LED is switched on permanently.
	Button-press display	The status LED indicates a button actuation. The ON time is set on the parameter page "General" in common for all status LEDs that are configured as actuation displays.
	Telegram acknowledgment	The status LED indicates the transmission of a telegram in 2-channel operation. This setting can only be configured for the pushbutton or rocker function "2-channel operation".
	Status display (switching object)	In the "Switching" and "Dimming" push-button functions, the status LED signals the status of the "Switching" object and, in the "Fan controller" and "Setpoint shift" push-button functions, it signals the status of the push-button function. In the "Switching" and "Dimming" functions, the object value is evaluated as following: "ON" -> "LED illuminated / OFF" -> LED goes out.
	Inverted status display (switching object)	In the "Switching" and "Dimming" push-button functions, the status LED signals the inverted status of the "Switching" object and, in the "Fan controller" and "Setpoint shift" push-button functions, it signals the inverted status of the push-button function. In the "Switching" and "Dimming" functions, the object value is evaluated as following: "OFF" -> "LED

	illuminated / ON" -> LED goes out.
Control via separate LED object	The status LED indicates the state of its own, separate 1-bit LED object. This setting causes the additional parameter "Control of the status LED via object value" to be shown.
Button function active display	The status LED indicates the state of the presence button in case of controller extension operation. The LED lights up if the presence function is activated. The LED is off if the presence function is inactive. This setting can only be configured in the pushbutton function "Controller extension" and with the button function "Presence button".
Button function inactive display	The status LED indicates the state of the presence button in case of controller extension operation. The LED lights up if the presence function is inactive. The LED is off if the presence function is activated. This setting can only be configured in the pushbutton function "Controller extension" and with the button function "Presence button".
Operating mode display (KNX controller)	The status LED indicates the state of a KNX room temperature controller via a separate 1-byte communication object. This setting causes the additional parameter "Status LED ON with" to be shown. The setting cannot be configured with the push-button functions "Controller extension", "Fan control", "Controller operating mode change-over" or "Setpoint shift".
Comparator without sign (1-byte)	The status LED is activated depending on a comparison. In this configuration there is a separate 1-byte communication object available via which the unsigned reference value (0...255) is received. This setting causes the additional parameter "Status LED ON with" to be shown.
Comparator with sign (1-byte)	The status LED is activated depending on a comparison. In this configuration there is a separate 1-byte communication object available via which the positive or negative reference value (-128...127) is received. This setting causes the additional parameter "Status LED ON with" to be shown.

		The presetting of the parameter "Function of status LED" depends on the configured pushbutton or rocker function.
The function of the status LED = "Display via separate LED object"...		
Control of the status LED via object value	1 = LED static ON / 0 = LED static OFF 1 = LED static OFF / 0 = LED static ON 1 = LED flashes / 0 = LED static OFF 1 = LED static OFF / 0 = LED flashes	If the "Function of status LED ..." is set to "Control via separate LED object", then the telegram polarity of the 1-bit object "Status LED" can be specified at this point. The LED can be switched on or off statically. In addition, the received switching telegram can be evaluated in such a way that the LED flashes.
If the function of status LED = "Operating mode display (KNX controller)"...		
Status LED ON with	Automatic mode Comfort mode Standby mode Night mode Frost/heat protection mode	The values of a communication object with data type 20.102 "HVAC Mode" are defined as follows: 0 = Automatic 1 = Comfort 2 = Standby 3 = Night 4 = Frost/heat protection The value "Automatic" is used only by the "forced operating mode switchover" objects. The status LED is illuminated when the object receives the value configured here.
If the function of status LED = "Comparator without sign"...		
Status LED ON with	Reference value greater than received value Reference value less than received value Reference value equal to received value	The status LED indicates whether the configured reference value is greater or less than or equal to the value of the "Status LED" object".
Reference value (0 ... 255)	0 ... 255	This parameter defines the reference value to which the value of the "Status LED" object is compared.

If the function of status LED = "Comparator with sign"...

Status LED ON with	Reference value greater than received value	The status LED indicates whether the configured reference value is greater or less than or equal to the value of the "Status LED" object".
	Reference value less than received value	
	Reference value equal to received value	
Reference value (-128 ... 127)	-128 ... 0 ... 127	This parameter defines the reference value to which the value of the "Status LED" object is compared.

push button sensor -> Disable

Disabling function?	Yes	With this parameter, the disabling function of the push button sensor can be centrally activated. If "Yes", the ETS shows further communication object and parameters.
	No	

Polarity of disabling object	disable = 1 / enable = 0	This parameter defines the value of the disabling object at which the disabling function is active.
	Disable = 0 / enable = 1	

Reaction of pushbutton sensor at the beginning of the disabling function	No reaction	Besides disabling of rocker and button functions, the pushbutton sensor can also and in addition trigger a specific function at the time of activation of the disabling state.
	Reaction as button >>X<< when pressed	
	Reaction as button >>X<< when released	This function can... correspond to the function assigned to any of the buttons in the non-disabled state ("Reaction as button >>X<< ..."), be defined on the following parameter pages ("Reaction as disabling function ..."), recall a scene stored internally in the pushbutton sensor ("Internal scene recall ...").
	Reaction as disabling function 1 when pressed	
	Reaction as disabling function 1 when released	
	Reaction as disabling function 2 when pressed	
	Reaction as disabling function 2 when released	
	Internal scene recall scene 1	
	Internal scene recall scene 2	
	Internal scene recall scene 3	

	Internal scene recall scene 4	
	Internal scene recall scene 5	
	Internal scene recall scene 6	
	Internal scene recall scene 7	
	Internal scene recall scene 8	
Button >>X<<	Button 1 Button 2 ... Button 6 *	If the pushbutton sensor is to perform the function of a specific button at the beginning of the disabling state, this button will be selected here. Visible only if "Reaction of pushbutton sensor at the beginning of the disabling function = Reaction as button >>X<< on pressing / releasing"! *: The number of buttons depends on the configured device variant!
Behaviour during active disabling	all buttons without function All buttons behave as Individual buttons without function Individual buttons behave as	While disabling is active... all buttons or only individually selected buttons can be disabled ("... no function"), all buttons or only individually selected buttons can be restricted to a specific function ("... behave as"). In this case, the ETS shows further parameters.
All left buttons with even numbers behave during disabling as	Button 1 Button 2 ... Button 6 * Disabling function 1 Disabling function 2	If a specific button function is to be assigned during disabling to all or to individual buttons, this parameter can be used to select the desired button the function of which will then be executed. During disabling, all the left buttons behave like the one configured here. The desired functions can either correspond to the function of an existing button or they can be configured as special disabling functions. Visible only if "Behaviour during active disabling = all buttons behave as" or "Behaviour during active disabling = individual buttons behave as"! *: The number of buttons depends on the configured device variant!

All right buttons with even numbers behave during disabling as	Button 1 Button 2 ... Button 6 * Disabling function 1 Disabling function 2	If a specific button function is to be assigned during disabling to all or to individual buttons, this parameter can be used to select the desired button the function of which will then be executed. During disabling, all the right buttons behave like the one configured here. The desired functions can either correspond to the function of an existing button or they can be configured as special disabling functions. Visible only if "Behaviour during active disabling = all buttons behave as" or "Behaviour during active disabling = individual buttons behave as"! *: The number of buttons depends on the configured device variant!
Reaction of pushbutton sensor at the end of disabling	No reaction Reaction as button >>Y<< when pressed Reaction as button >>Y<< when released Reaction as disabling function 1 when pressed Reaction as disabling function 1 when released Reaction as disabling function 2 when pressed Reaction as disabling function 2 when released Internal scene recall scene 1 Internal scene recall scene 2 Internal scene recall scene 3 Internal scene recall scene 4 Internal scene recall scene 5 Internal scene recall scene 6 Internal scene recall scene 7 Internal scene recall scene 8	Besides disabling of rocker and button functions, the pushbutton sensor can also trigger a special function immediately at the end of disabling. This function can... correspond to the function assigned to any of the buttons in the non-disabled state ("Reaction as button >>X<< ..."), be defined on the following parameter pages ("Reaction as disabling function ..."), recall a scene stored internally in the pushbutton sensor ("Internal scene recall ...").

Button >>Y<<

Button 1
Button 2
...
Button 6 *

If the pushbutton sensor is to perform the function of a specific button at the end of the disabling state, this button will be selected here.

Only visible if "Reaction of pushbutton sensor at the end of disabling = Reaction as button >>Y<< on pressing / releasing"!
*: The number of buttons depends on the configured device variant!

Pushbutton sensor -> Disable -> Disable - Button selection (only visible if "Behaviour during active disabling = individual buttons without function" or "Behaviour during active disabling = individual buttons behave as"!

Selection of buttons to be disabled.

Left display button ? **Yes**
Right display button ? **No**

Button 1 left?
Button 2 right ?
...
Button 6 right ? *

The user can specify for each button separately whether it will be affected by the disabling function during the disabling state.
*: The number of buttons depends on the configured device variant!

Pushbutton sensor -> Disable -> Disable - Disable function 1 / Disable - Disable function 2. With the exception of control of the status LED, the parameters available for the two disabling functions are the same as those for the push-button functions.

Pushbutton sensor -> Alarm message

Alarm signal display **Activated**
Deactivated

This parameter can be used to enable alarm signal displaying.
When alarm signalling is enabled, the ETS displays further parameters and up to two further communication objects.

Polarity of the alarm signalling object **Alarm when ON and alarm reset when OFF**
Alarm when OFF and alarm reset when ON

The alarm signalling object is used as an input for activating or deactivating alarm signal displaying.
If the object value corresponds to the "Alarm" state, all status LEDs and the operation LEDs flash with a frequency of approx. 2 Hz.

If the setting is "Alarm when OFF and alarm reset when ON", the object must first be actively written by the bus with "0" to activate the alarm after a reset.

An alarm signal is not stored so that the

		alarm signalling is generally deactivated after a reset or after programming with the ETS.
Reset alarm signalling by a button-press?	Yes No	If this parameter is set to "Yes", active alarm signal displaying can be deactivated by a button-press on the push button sensor. This button-press does not cause the configured function of the pressed button to be executed. Only after then next button-press will the configuration of the button be evaluated and a telegram be transmitted to the bus, if applicable. If "No" has been selected, alarm signalling can only be deactivated via the alarm signalling object. A button-press will always execute the configured button function.
Use the alarm acknowledge object?	Yes No	If alarm signalling can be deactivated by a button-press, this parameter defines whether an additional alarm acknowledge telegram is to be transmitted to the bus via the separate object "Alarm signalling acknowledge" after triggering by this button-press. A telegram can, for instance, be sent via this object to the "Alarm signalling" objects of other push button sensors in order to reset the alarm status there as well (observe the polarity of the acknowledge object!).
Acknowledge alarm signalling by	OFF telegram ON telegram	This parameter sets the polarity of the "Alarm signalling acknowledge" object. This parameter presetting depends on the selected polarity of the alarm message object.

4.2.5.3 Parameter for the controller function section

Description	Values	Comment
<input type="checkbox"/> Room temperature control		
Room temperature controller function		The controller function block integrated in the device can either work as a main controller or, alternatively, as a controller extension. The setting of this parameter has a major impact on the function and on the other parameters and objects displayed in the ETS.
	Switched-off	The controller function block is switched off completely. No room temperature control and controller extension function can be executed by the device. It is only possible to switch to the second operating level using the display buttons of the device, in order to activate the Cleaning function as necessary. Controller operation is not possible.
	Switched-on	The controller function block works as a main controller. The internal control algorithm is active, meaning that the device can be used for single-room temperature control. The basic setpoint of the internal controller can be adjusted using the display buttons of the device. In addition, the menu items of the second operation level, which affect the controller, can be opened and operated. In necessary, the cleaning function can also be activated.
	Controller extension	The controller function block works as a controller extension. A controller extension itself is not involved in the regulating process. With it, the user can operate the single-room controller, i.e. the main controller from different places in the room. Any number of controller extensions can be controlled by a main controller. The basic setpoint of an external controller can be adjusted using the display buttons. In the display, the setpoint shift is displayed as a relative value. In addition, it is possible to switch to the second operating level, in order to activate the Cleaning function as necessary. In the function as a controller extension, adjustment of additional parameters in the second operating level is not possible using the display buttons.

Room temperature control (addition for controller extension)

Value request from controller extension?	Yes No	To ensure that all the objects are updated correctly, some communication objects of the controller extension can also initialise automatically after a device restart. For this, this parameter can be set to "Yes". The update then takes place after a reset by means of a ValueRead telegram to the room temperature controller. This must answer the request with a ValueResponse telegram.
Controller operating mode	Heating Cooling heating and cooling	Besides the operating function, the controller extension also possesses a display function. As on the main controller, various items of status information of the temperature controller can be shown on the device display. As the displayed states and information and also some operating functions are strongly dependent on the parameterisation of the main controller, the controller extension must also be configured and thus match the functions of the main controller. It should be ensured that the settings match those of the main controller. Due to the controller operating mode setting, some parameters may not be visible.
Controller sends heating and cooling command values to a shared object	Yes No	
Type of heating control	Continuous PI control Switching PI control (PWM) 2-point feedback control	
Type of cooling control	Continuous PI control Switching PI control (PWM) 2-point feedback control	
Controller outputs Heating command value in inverted fashion	Yes No	
Controller outputs Cooling command value in inverted fashion	Yes No	
Fan controller variable available	Yes No	
Number of fan levels	No fan levels 1 fan level 2 fan levels 3 fan levels 0 K + 1 K	

Upward adjustment of basic setpoint temperature

- + 2 K
- + 3 K**
- + 4 K
- + 5 K
- + 6 K
- + 7 K
- + 8 K
- + 9 K
- + 10 K

Downward adjustment of basic setpoint temperature

- 0 K
- + 1 K
- + 2 K
- + 3 K**
- + 4 K
- + 5 K
- + 6 K
- + 7 K
- + 8 K
- + 9 K
- + 10 K

Setpoint shifting display **Relative indication**

This parameter cannot be set. The basic setpoint shift indication on the controller extension is always relative.

Room temperature control -> Controller general

Controller operating mode

- Heating**
- Cooling
- heating and cooling
- Basic and additional heating
- Basic and additional cooling
- Basic and additional heating and cooling

The room temperature controller distinguishes between two different operating modes. The operating modes specify whether you want the controller to use its variable to trigger heating systems ("heating" single operating mode) or cooling systems ("cooling" single operating mode). You can also activate mixed operation, with the controller being capable of changing over between "Heating" and "Cooling" either automatically or, alternatively, controlled by a communication object. In addition, you can establish two-level control operation to control an additional heating or cooling unit. For two-level feedback control, separate command values will be calculated as a function of the temperature deviation between the setpoint and the actual value and transmitted to the bus for the basic and additional levels. This parameter specifies the operating mode and, if necessary, enables the additional level(s).

Fan controller available Yes
No

The room temperature control can be supplemented with a fan controller using this parameter. By enabling the fan

		<p>controller ("Yes" setting), it is possible to control the fan from heating and cooling systems operated by circulating air, such as fan coil units (FanCoil units), depending on the command value calculated in the controller or using manual operation.</p> <p>When the function is enabled additional parameters will appear in the ETS in the "Room temperature control -> Controller general -> Fan controller" as well as additional communication objects. Fan control is not possible with switching 2-point feedback control.</p>
Fan operating mode	Heating Cooling heating and cooling Basic heating Additional heating Basic cooling Additional cooling Basic heating and cooling Basic heating and additional cooling Basic cooling and additional heating Additional heating and cooling	<p>Depending on the operating mode of the room temperature control, as configured in the ETS, various controller command values can be used as the basis for fan control. The "Fan operating mode" parameter specifies which command value of the controller controls the fan controller. With one-level room temperature control, it is possible to select whether the fan is activated during heating and/or during cooling. With two-level room temperature control, it is also possible for the fan controller to be set to the basic level or the additional level during heating and cooling. However, under no circumstances is it possible to use the basic and additional levels simultaneously for a fan controller within an operating mode.</p> <p>This basic setting of this parameter depends on the selected controller operating mode.</p>
Additional level disabling object	Yes No	<p>The additional levels can be separately disabled via the bus. The parameter enables the disable object as necessary. This parameter is only visible in two-level heating and cooling operation.</p>
Send variable heating and cooling to one common object	Yes No	<p>If the parameter is set to "Yes", the command value will be transmitted on a shared object during heating or cooling. This function is used, if the same heating system is used to cool the room in the summer and used to heat the room in the winter.</p> <p>This parameter is only visible with "heating and cooling" mixed operating mode, if applicable, with additional levels.</p>

Type of heating control (if applicable, for basic and additional stage)	Continuous PI control Switching PI control (PWM) Switching 2-point control (ON/OFF)	Selecting a feedback control algorithm (PI or 2-point) with data format (1-byte or 1-bit) for the heating system.
Type of heating (if applicable, for basic and additional level)	Hot water heater (5 K / 150 min) Underfloor heating (5 K / 240 min) Electric heating (4 K / 100 min) Fan convector (4 K / 90 min) Split unit (4 K / 90 min) via control parameter	Adapting the PI algorithm to different heating systems using predefined values for the proportional range and reset time control parameters. With the "Using control parameters" setting, it is possible to set the control parameters in a manner deviating from the predefined values within specific limits. This parameter is only visible if "Type of heating control = Continuous PI control".
Proportional range heating (10 ... 127) * 0.1 K	10 ... 127, 50	Separate setting of the "Proportional range" control parameter. This parameter is only visible if "Type of heating = via control parameter" and the heating control type "PI control".
Reset time heating (0 ... 255) * 1 min; 0 = inactive	0 ... 255, 150	Separate setting of the "Reset time" control parameter. This parameter is only visible if "Type of heating = via control parameter" and the heating control type "PI control".
Top hysteresis of the 2-point controller heating (5 ... 127) * 0.1 K	5 ... 127, 5	Definition of top hysteresis (switch-off temperatures) of the heating. This parameter is only visible if "Type of heating control = Switching 2-point feedback control (ON/OFF)".
Bottom hysteresis of the 2-point controller heating (-128 ... -5) * 0.1 K	-128 ... -5, -5	Definition of bottom hysteresis (switch-on temperatures) of the heating. This parameter is only visible if "Type of heating control = Switching 2-point feedback control (ON/OFF)".
Type of cooling control (if applicable, for basic and additional stage)	Continuous PI control Switching PI control (PWM) Switching 2-point control (ON/OFF)	Selecting a feedback control algorithm (PI or 2-point) with data format (1-byte or 1-bit) for the cooling system.

Type of cooling (if applicable, for basic and additional level)	<p>Cooling ceiling (5 K / 240 min)</p> <p>Electric heating (4 K / 100 min)</p> <p>Fan convector (4 K / 90 min)</p> <p>Split unit (4 K / 90 min)</p> <p>via control parameter</p>	<p>Adapting the PI algorithm to different cooling systems using predefined values for the proportional range and reset time control parameters.</p> <p>With the "Using control parameters" setting, it is possible to set the control parameters in a manner deviating from the predefined values within specific limits.</p> <p>This parameter is only visible if "Type of cooling control = PI control".</p>
Proportional range heating (10 ... 127) * 0.1 K	10 ... 127, 50	<p>Separate setting of the "Proportional range" control parameter.</p> <p>This parameter is only visible if "Type of cooling = via control parameter" and the cooling control type "PI control".</p>
Reset time heating (0 ... 255) * 1 min; 0 = inactive	0 ... 255, 150	<p>Separate setting of the "Reset time" control parameter.</p> <p>This parameter is only visible if "Type of cooling = via control parameter" and the cooling control type "PI control".</p>
Top hysteresis of the 2-point controller cooling (5 ... 127) * 0.1 K	5 ... 127, 5	<p>Definition of top hysteresis (switch-on temperatures) of the cooling.</p> <p>This parameter is only visible if "Type of cooling control = Switching 2-point feedback control (ON/OFF)".</p>
Bottom hysteresis of the 2-point controller heating (-128 ... -5) * 0.1 K	-128 ... -5, -5	<p>Definition of bottom hysteresis (switch-off temperatures) of the cooling.</p> <p>This parameter is only visible if "Type of cooling control = Switching 2-point feedback control (ON/OFF)".</p>
Operating mode switch-over	<p>Via value (1 byte)</p> <p>Via switching (4 x 1 bit)</p>	<p>The change-over of the operating modes via the bus takes place according to the KNX specification via a 1 byte value object. In addition, a higher-ranking forced-object is available for this setting.</p> <p>The 'classic' change-over of the operating modes via the bus is via four separate 1-bit objects.</p>
Operation mode after reset	<p>Comfort mode</p> <p>Standby mode</p> <p>Night operation</p> <p>Frost/heat protection mode</p>	<p>This parameter specifies which operating mode is set immediately after a device reset.</p>

<p>Operating mode when all bit objects = 0 (Preferred position)</p>	<p>Comfort mode Standby mode Night operation Frost/heat protection mode Last status before change to 0</p>	<p>This parameter specifies which operating mode is activated when all 1 bit operating mode objects have the value"0". This parameter is only visible with the 4 x 1 bit operating mode change-over.</p>
<p>Change-over between heating and cooling</p>	<p>Automatic</p>	<p>In a configured mixed mode it is possible to switch over between heating and cooling.</p>
	<p>Via object (heating/cooling change-over)</p>	<p>Depending on the operating mode and the room temperature, the switch-over takes place automatically. The change-over takes place only via the object "Heating / cooling change-over".</p>
<p>Heating / cooling operating mode after reset</p>	<p>Heating Cooling Operating mode before reset</p>	<p>The preset operating mode for after the return of the bus voltage is specified here. Only visible if "Change-over between heating and cooling = via object"!</p>
<p>Automatic heating/cooling switch-over transmission</p>	<p>On changing the operating mode On changing the output value</p>	<p>Here, it is possible to specify when a telegram is transmitted automatically onto the bus via the object "Heating / cooling change-over". Only visible if "Change-over between heating and cooling = automatic".</p>
<p>Cyclical transmission heating/cooling change-over (0...255) * 1 min; 0 = inactive</p>	<p>0 ... 255, 0</p>	<p>This parameter specifies whether the current object status of the "Heating / cooling change-over" object should be output cyclically to the bus on an automatic change-over. The cycle time can be set here. The "0" setting will deactivate the periodic transmission of the object value. Only visible if "Change-over between heating and cooling = automatic".</p>
<p><input type="checkbox"/> Room temperature control -> Controller general -> Room temperature measurement</p>		
<p>Temperature/remote sensor connected?</p>	<p>Yes No</p>	<p>The pushbutton sensor offers the option of direct connection of a wired temperature/remote sensor. This sensor can be used for room temperature measurement of to limit floor temperatures. If a wired temperature/remote sensor is connected to the pushbutton sensor, the sensor connection must be activated in the device software. To do this, set this parameter to "Yes". If this parameter is</p>

		configured to "No", then the sensor connection is inactive.
Temperature/remote sensor used for		The wired temperature sensor can execute two alternative functions. The "Temperature/remote sensor used for" parameter specifies the type of use.
	Room temperature measurement	The wired temperature sensor is used to measure the local room temperature. This means that the sensor is evaluated exclusively as an external sensor for room temperature measurement.
	Temperature limited (Underfloor heating)	The wired temperature sensor is used to measure the temperature of an underfloor heating system. This permits temperature limitation. The parameter is permanently set to "Room temperature measurement" and cannot be changed, if the operating mode is configured as "Cooling", meaning that no floor temperature limitation is possible.
Temperature detection		This parameter specifies which sensor is used for room temperature measurement.
	internal sensor	Only the temperature sensor integrated in the device detects the room temperature. This setting cannot be selected when the wired temperature/remote sensor is used for room temperature measurement.
	External sensor	Only a KNX/EIB temperature sensor (e.g. controller extension) coupled via the "External temperature sensor" object detects the room temperature. This setting cannot be selected when the wired temperature/remote sensor is used for room temperature measurement.
	Internal and external sensor	The sensor integrated in the device and a KNX/EIB temperature sensor (e.g. controller extension) coupled via the "External temperature sensor" object detect the room temperature. This setting cannot be selected when the wired temperature/remote sensor is used for room temperature measurement.
	Temperature/remote sensor	Only the wired temperature/remote sensor detects the room temperature. This setting cannot be selected when the wired temperature/remote sensor is used for floor temperature limitation.

	Internal sensor and temp./ remote sensor	The sensor integrated in the device and the wired temperature/remote sensor detect the room temperature. This setting cannot be selected when the wired temperature/remote sensor is used for floor temperature limitation. The presetting of this parameter depends on the enabling and use of the wired temperature/remote sensor.
Determination of measured value from internal / external ratio	10% to 90% 20% to 80% 30% to 70% 40% to 60% 50% to 50% 60% to 40% 70% to 30% 80% to 20% 90% to 10%	The weighting of the measured temperature value for the internal and external sensors is specified here. That results in an overall value, which will be used for the further interpretation of the room temperature. If the wired temperature/remote sensor is used for room temperature measurement, this parameter defines the weighting between the wired and internal sensors.
Internal sensor calibration (-128...127) * 0.1 K	-128 ... 127, 0	Determines the value by which the internal sensor's room temperature value is calibrated. This parameter is only visible when the temperature detection system requires an internal sensor.
External sensor calibration (-128...127) * 0.1 K	-128 ... 127, 0	Determines the value by which the external sensor's room temperature value is calibrated. This parameter is only visible when the temperature detection system requires an external sensor.
Temperature/remote sensor calibration (-128...127) * 0.1 K	-128 ... 127, 0	Determines the value by which the wired temperature/remote sensor's room temperature value is calibrated. This parameter is only visible when the temperature detection system requires an a temperature/remote sensor.
Scanning time for external sensor (0...255) * 1 min; 0 = inactive	0 ... 255, 0	The polling time for the external sensor's temperature value is specified here. In the "0" setting, the external sensor is not automatically polled by the controller. In this case, the sensor must transmit its temperature value itself. This parameter is not visible when the wired temperature/remote sensor is used for room temperature measurement.

Transmission when room temperature change by (0..255) * 0.1 K; 0 = No automatic transmission	0 ... 255, 3	Determines the size of the value change of the room temperature after which the current values are automatically transmitted on the bus via the "Actual temperature" object.
Cyclical transmission of room temperature (0..255) * 1 min; 0 = inactive	0 ... 255, 15	This parameter specifies whether and when the determined room temperature is to be periodically output via the "Actual temperature" object.
Underfloor heating temperature limit available	Yes No	The temperature limit can be activated in the controller in order to protect an underfloor heating system. If the temperature limit is enabled here ("Yes" setting), the controller continuously monitors the floor temperature. Should the floor temperature exceed a specific limiting value on heating, the controller immediately switches the command value off, thus switching the heating off and cooling the system. Only when the temperature falls below the limiting value, minus a hysteresis of 1 K, will the controller add the most recently calculated command value. The presetting of this parameter depends on the enabling and use of the wired temperature/remote sensor. The floor temperature can either be fed to the controller using a separate object or using the wired temperature/remote sensor (depending on the parameter "Temperature/remote sensor used for"). It should be noted that the temperature limit only affects command values for heating. Thus, the temperature limit requires the controller operating modes "Heating" or "Heating and cooling".
Effect on	Heating, basic level Heating, additional level	The temperature limit can also be used in a two-level feedback control with basic and additional levels. It must then be specified here to which level the limit shall apply. Either the basic level or to the additional level for heating can be limited. This parameter can only be set in two-level control operation.
Maximum temperature, underfloor heating * 1 °C	20 ... 70, 30	The maximum limit temperature which the underfloor heating system may reach is specified here. If this temperature is exceeded, the controller switches the underfloor heating system off using the command value. As soon as the floor temperature has fallen 1 K

under the limit temperature, the controller switches the command value on again, assuming that this is intended in the control algorithm. The 1 K hysteresis is fixed and cannot be changed.

□ Room temperature control -> Controller general -> Fan controller

Number of fan levels	No fan levels 1 fan level 2 fan levels 3 fan levels	The fan controller of the room temperature controller supports up to three fan level outputs, for which the actually used number of levels (1...3) is set using this parameter.
Fan level change-over via	via switching objects (3 x 1 bit) via value object (1-byte)	Depending on the data format of the objects of the controlled actuators, the switchover between the fan levels can either take place via up to three separate 1-bit objects or, alternatively, via one 1-byte object. The "Fan level change-over via" parameter defines the data format of the controller. With the 1-bit objects, each fan level discreetly receives its own object. With the 1-byte object, the active fan level is expressed by a value ("0" = Fan OFF / "1" = Level 1 / "2" = Level 2 / "3" = Level 3).
Fan OFF threshold value -> Level 1, * 1 %	0 ... 100, 1	In automatic operation, the command value of the controller is used internally in the device for automatic control of the fan levels. As a transition between the levels, there are threshold values, defined according to the command value of the controller, which can be set here. If the command value exceeds the threshold value of a level, the appropriate level is activated. If the command value sinks below a threshold value, minus the configured hysteresis, then the change-over takes place into the next lowest fan level.
Fan level 1 threshold value -> Level 2, * 1 %	0 ... 100, 30	
Fan level 2 threshold value -> Level 3, * 1 %	0 ... 100, 60	
Hysteresis between threshold values, *1%	1 ... 50, 3	If the command value of the room temperature control has undershot the threshold value minus the hysteresis, the fan controller switches back to the previous level.

Waiting time for level change-over *0.1 s	1 ... 255, 2	Due to fan motors' inertia, as a rule there is a limit to how short the time intervals for switching the fan levels can be, i.e. there is a limit to how quickly the fan speed can be varied. If the fan controller is working in automatic mode, the settable "Waiting time on level change-over" is maintained on change-over of the levels.
Level limit (max. fan level)	No level limit Fan level 1 Fan level 2	<p>To reduce the fan noise of a fan coil, the fan level limit can be activated. The level limit reduces the sound emissions by limiting the maximum fan level to a fan level value configured here (limitation level). The limit can be switched on and off using the "Fan, level limit" 1-bit object and thus activated as necessary.</p> <p>The parameter "Level limit" is not checked for plausibility in the ETS, meaning that an implausible parameterisation is possible. For this reason, care should be taken to ensure that there is no limit level in the configuration which is higher than the actual fan levels. If a higher limit level is configured, then the limit has no effect.</p>
Behaviour on forced position	No forced position Fan level 1 Fan level 2 Fan level 3 Fan level OFF	<p>The controller provides the option of activating a forced fan position via the bus. With an active forced position, the fan levels can neither be controlled nor switched over in either automatic or manual mode. The fan remains in the forced state until the forced position is removed using the bus. In this manner, it is possible to switch the fan to a locked and controlled state, for example for servicing purposes.</p> <p>As soon as the forced position is activated, the controller jumps to the fan level configured in this parameter without any waiting time. The fan can also be completely switched off.</p>
Object interpretation, automatic/manual fan control	0=Automatic mode, 1=Manual mode 1=Automatic mode, 0=Manual mode	The parameter specifies the polarity of the object for the change-over between automatic and manual fan control. Automatic mode is always active after a device reset.
Fan level on change-over to manual	No change Fan level 1	On change-over from automatic operation to manual operation, this

	Fan level 2 Fan level 3 Fan level OFF	parameter then decides whether the fan level most recently set in automatic operation is maintained, the fan is switched off or a defined fan level is set. The parameter "Fan level on change-over to manual" is not checked for plausibility in the ETS, meaning that an implausible parameterisation is possible. For this reason, care should be taken to ensure that there is no level in the configuration which is higher than the actual fan levels. If a level which does not exist is to be configured for the change-over to manual control, then the fan controller changes over to the maximum possible level when changing over to manual operation.
Heating fan run-on time, *0.1 s, 0=Inactive	0 ... 255, 0	If the fan is switched-off in automatic or manual operation, it runs on for the time configured at this point, provided that a factor of more than "0" is set. This parameter applies to the controller operating mode "Heating" (if necessary, in the basic and additional levels).
Cooling fan run-on time, *0.1 s, 0=Inactive	0 ... 255, 0	If the fan is switched-off in automatic or manual operation, it runs on for the time configured at this point, provided that a factor of more than "0" is set. This parameter applies to the controller operating mode "Cooling" (if necessary, in the basic and additional levels).
Fan protection	Yes No	The fan protection function allows the fan of a fan coil unit, which has not been active for some time, to be temporarily switched to the maximum level. In this way, the controller fan motors can be protected against stiffness. In addition, the fan blades and the heat exchanger of the fan coil unit are protected against dust against dust. If the fan protection is to be used, it must be enabled using the "Yes" setting at this point.
Start-up using level	Fan level OFF Fan level 1 Fan level 2 Fan level 3	The fan can, if it was switched off before and should now start up, be switched on at a defined switch-on level. This switch-on level can be any of the available fan levels, and is set using this parameter. The switch-on level is usually one of the higher fan levels of a blower convector. The switch-on level remains active for the "Waiting time on level change-over"

configured in the ETS.

The parameter "Start-up via level" is not checked for plausibility in the ETS, meaning that an implausible parameterisation is possible. For this reason, care should be taken to ensure that there is no switch-on level in the configuration which is higher than the actual fan levels. The fan controller automatically corrects a faulty parameterisation by activating level 1 for the start-up, meaning that the fan starts up normally without a switch-on level.

Command value is 0%, until internal command value is greater than, *1% 1 ... 100, **1**

The command value evaluated by the fan controller in automatic operation can be optionally limited by this parameter in the bottom command value range.

Command value is 100%, as soon as internal command value is greater than, *1% 1 ... 100, **99**

The command value evaluated by the fan controller in Automatic mode can be optionally limited by this parameter in the top command value range.

Command value offset, *1% 0 ... 100, **0**

The command value evaluated by the fan controller in Automatic mode can be optionally raised by the static offset configured here. Should the calculation produce a value of over 100 %, then the command value is limited to the maximum value.

☐ Room temperature control -> Controller general -> Command value and status output

Automatic transmission at modification by (0...100) * 1 %; 0 = inactive 0 ... 100, **3**

This parameter determines the size of the command value change that will automatically transmit continuous command value telegrams via the command value objects. Thus this parameter only affects command values which are configured to "Continuous PI control" and to the 1 byte additional command value objects of the "Switching PI control (PWM)".

Cycle time of the switching command value (1...255) * 1 min 1 ... 255, **15**

This parameter specifies the cycle time for the pulse width modulated command value (PWM). Thus this parameter only affects command values which are configured to "Switching PI control (PWM)".

Cycle time for automatic transmission (0...255) * 1 min; 0 = inactive	0 ... 255, 10	This parameter determines the time interval for the cyclical transmission of the command values via the command value objects. This parameter only affects command values which are configured to "Continuous PI control" or "Switching PI feedback control (PWM)".
Output of the heating command value	Inverted (under current, this means closed) Normal (under current, this means opened)	At this point, it is possible to specify whether the command value telegram for heating is output normally or in inverted form. This parameter is only visible if the operating mode "Heating" or "Heating and cooling" is configured and not two-level operation.
Output of the heating basic level command value	Inverted (under current, this means closed) Normal (under current, this means opened)	At this point, it is possible to specify whether the command value telegram for the heating basic level is output normally or in inverted form. This parameter is only visible if the operating mode "Heating" or "Heating and cooling" is configured along with two-level operation.
Output of the heating additional level command value	Inverted (under current, this means closed) Normal (under current, this means opened)	At this point, it is possible to specify whether the command value telegram for the heating additional level is output normally or in inverted form. This parameter is only visible if the operating mode "Heating" or "Heating and cooling" is configured along with two-level operation.
Output of the cooling command value	Inverted (under current, this means closed) Normal (under current, this means opened)	At this point, it is possible to specify whether the command value telegram for cooling is output normally or in inverted form. This parameter is only visible if the operating mode "Cooling" or "Heating and cooling" is configured and not two-level operation.
Output of the cooling basic level command value	Inverted (under current, this means closed) Normal (under current, this means opened)	At this point, it is possible to specify whether the command value telegram for the cooling basic level is output normally or in inverted form. This parameter is only visible if the operating mode "Cooling" or "Heating and cooling" is configured along with two-level operation.

Output of the cooling additional level command value	Inverted (under current, this means closed) Normal (under current, this means opened)	At this point, it is possible to specify whether the command value telegram for the cooling additional level is output normally or in inverted form. This parameter is only visible if the operating mode "Cooling" or "Heating and cooling" is configured along with two-level operation.
Heating message	Yes No	Depending on the set operating mode, a separate object can be used to signal whether the controller is currently demanding heating energy and is thus actively heating. The "Yes" setting here enables the message function for heating.
Cooling message	Yes No	Depending on the set operating mode, a separate object can be used to signal whether the controller is currently demanding cooling energy and is thus actively cooling. The "Yes" setting here enables the message function for cooling.
Controller status	No status Controller general Transmit individual state	The controller can output its current operating status. A distinction is made whether the status signal is transmitted to the bus via a 1 byte telegram or a 1 bit telegram. In the "Controller general" setting, various status signals of the controller are output as a collective signal via an object of 1 byte. Each bit represents one piece of status information. In the setting "Transmit individual status", the controller status is transmitted onto the bus as a single 1 bit status signal. The "Single status" parameter specifies the status information to be transmitted individually.
Single status	Comfort mode Active Standby mode activated Night mode activated Frost/heat protection active Controller disabled Heating / cooling Controller inactive Frost alarm	Here, the status information is defined, which is to be transmitted onto the bus as the controller status. This parameter is only visible if the parameter "Controller status" is set to "Transmit single status".

☐ Room temperature control -> Controller general -> Setpoints

Basic temperature after reset (7 ... 40) * 1 °C	0 ... 100, 3	This parameter defines the temperature value to be applied as the basic setpoint after commissioning by the ETS. All the temperature setpoints are derived from the basic setpoint.
Permanently apply change to basic setpoint shift	No Yes	<p>In addition to the setting of individual temperature setpoints via the ETS, the user is able to shift the basic setpoint within a settable range anytime via local control or via the basic setpoint object, either using the display buttons or with the "Setpoint shift" push button function, if this is configured to a function button of the push button sensor. Whether a basic setpoint shifting only affects the currently active operating mode or whether it influences all other setpoint temperatures of the remaining operating modes is determined by this parameter.</p> <p>In the "Yes" setting, the shift of the basic setpoint carried out affects all operating modes. The shifting is maintained even after change-over of the operating mode or the heating/cooling mode or readjusting the basic setpoint.</p> <p>In the "No" setting, the basic setpoint shift carried out is in effect for only as long as the operating mode or heating/cooling mode has not changed or the basic setpoint is maintained. Otherwise the setpoint shift will be reset to "0".</p>
Changing of the basic temperature setpoint value via bus	Deactivated Approve	Here, it is possible to specify if it is possible to change the basic setpoint via the bus. In the "Approve" setting, the "Basic setpoint" object is visible in the ETS.
Accept modification of the basic temperature setpoint value permanently	No Yes	<p>One has to distinguish between two cases, defined by this parameter, if the basic setpoint has been modified (via local control or via the object):</p> <p>In the "Yes" setting, the controller saves the basic setpoint permanently in the EEPROM. The newly adjusted value will overwrite the basic temperature originally configured via the ETS after a reset! This is the only way to keep the adjusted basic setpoint even after change-over of the operating mode or after a reset.</p> <p>In the "No" setting, the basic setpoint, which was set on the room temperature</p>

		controller or received via the object, stays only temporarily active in the current operating mode. In case of a bus voltage failure or following a change-over to another operating mode (e.g. Comfort followed by Standby), the basic setpoint set via local control or received via the object will be discarded and replaced by the value which was originally configured in the ETS.
Frost protection setpoint temperature (7...40) * 1 °C	7 ... 40, 7	This parameter specifies the setpoint temperature for frost protection. The parameter is only visible in "Heating" or "Heating and cooling" operating modes (if necessary with additional levels).
Heat protection setpoint temperature (7...45) * 1 °C	7 ... 45, 35	This parameter specifies the setpoint temperature for heat protection. The parameter is only visible in "Cooling" or "Heating and cooling" operating modes (if necessary with additional levels).
Deadband position	symmetrical asymmetrical	<p>The comfort setpoint temperatures for "Heating and cooling" operating modes are derived from the basic setpoint in consideration of the adjusted deadband. The deadband (temperature zone for which there is neither heating nor cooling) is the difference between the comfort setpoint temperatures. Symmetrical setting: the deadband preset in the ETS plug-in is divided in two parts at the basic setpoint. The comfort setpoint temperatures are derived directly from the basic setpoint resulting from the half deadband (Basic setpoint - 1/2 deadband = Heating comfort temperature or Basic setpoint + 1/2 deadband = Cooling comfort temperature).</p> <p>Asymmetrical setting: with this setting the comfort setpoint temperature for heating equals the basic setpoint! The preset deadband is effective only from the basic setpoint in the direction of comfort temperature for cooling. Thus the comfort set-temperature for cooling is derived directly from the comfort setpoint for heating. The parameter is only visible in "Heating and cooling" operating modes (if necessary with additional levels).</p>

Dead band between heating and cooling	<p>0 0.5 K 1.0 K ... 2.0 K ... 12.0 K 12.5 K</p>	<p>The comfort setpoint temperatures for heating and cooling are derived from the basic setpoint in consideration of the adjusted deadband. The deadband (temperature zone for which there is neither heating nor cooling) is the difference between the comfort setpoint temperatures. It is set using this parameter. The parameter is only visible in "Heating and cooling" operating modes (if necessary with additional levels).</p>
Difference between basic and additional levels (0...127) * 0.1 K	0 ... 127, 20	<p>In a two-level control mode, it is necessary to determine the temperature difference to the basic level with which the additional level is to be incorporated into the feedback control. This parameter defines the level spacing. The parameter can only be seen in two-level control operation.</p>
Transmission at setpoint temperature change by (0...255) * 0.1 K	0 ... 255, 1	<p>Determines the size of the value change required to automatically transmit the current value via the "Setpoint temperature" object. In the "0" setting, the setpoint temperature is not transmitted automatically when there is a change.</p>
Cyclical transmission of setpoint temperature (0...255) * 1 min; 0 = inactive	0 ... 255, 0	<p>This parameter determines whether the setpoint temperature is to be transmitted periodically via the "Setpoint temperature" object. Definition of the cycle time by this parameter In the "0" setting, the setpoint temperature is not transmitted automatically cyclically.</p>
Upward adjustment of basic setpoint temperature	<p>0 K + 1 K + 2 K + 3 K + 4 K + 5 K + 6 K + 7 K + 8 K + 9 K + 10 K</p>	<p>The top temperature range, settable with a basic setpoint shift, is defined by this parameter. It is possible to shift the current setpoint by a maximum of +/- 10 K. The incremental distance of a setpoint shift is permanently set to 0.5 K.</p>
	<p>0 K + 1 K</p>	<p>The lower temperature range, settable with a basic setpoint shift, is defined by</p>

Downward adjustment of basic setpoint temperature	+ 2 K + 3 K + 4 K + 5 K + 6 K + 7 K + 8 K + 9 K + 10 K	this parameter. It is possible to shift the current setpoint by a maximum of +/- 10 K. The incremental distance of a setpoint shift is permanently set to 0.5 K.
Setpoint shifting display	Absolute indication Relative indication	The basic setpoint shift indication is dependent on this parameter. When setting the basic setpoint shift, the absolute indication shows the currently adjusted setpoint temperature of the active operating mode. The device always rounds the indication to half degrees and shows the rounded-off temperature in the display. The relative display will only show the current setpoint shift in °C without also reading the setpoint temperature derived from it. Example: Setpoint temperature without shift: 21.0 °C (indication: 0) -> new setpoint shift: +0.5 °C -> indication: +0.5 °C. This representation corresponds to the adjusting wheel of a conventional room temperature controller.
Lower the setpoint temperature during standby operating mode (heating)	0 - 0.5 K - 1.0 K ... - 2.0 K ... - 12.0 K - 12.5 K	The value by which the standby setpoint temperature for heating is lowered compared to the heating comfort temperature. The parameter is only visible in "Heating" or "Heating and cooling" operating modes (if necessary with additional levels).
Lower the setpoint temperature during Night mode (heating)	0 - 0.5 K - 1.0 K ... - 4.0 K ... - 12.0 K - 12.5 K	The value by which the night setpoint temperature for heating is lowered compared to the heating comfort temperature. The parameter is only visible in "Heating" or "Heating and cooling" operating modes (if necessary with additional levels).
Raise the setpoint temperature during standby operating mode (cooling)	0 + 0.5 K + 1.0 K ... + 2.0 K ... + 12.0 K + 12.5 K	The value by which the standby setpoint temperature for cooling is lowered compared to the cooling comfort temperature. The parameter is only visible in "Cooling" or "Heating and cooling" operating modes (if necessary with additional levels).

Raise the setpoint temperature during Night mode (cooling)	0 + 0.5 K + 1.0 K ... + 4.0 K ... + 12.0 K + 12.5 K	The value by which the night temperature for cooling is lowered compared to the cooling comfort temperature. The parameter is only visible in "Cooling" or "Heating and cooling" operating modes (if necessary with additional levels).
Setpoint temperature limit in cooling operation	No limit Only difference to outdoor temperature Only max. setpoint temperature Max. setpoint and difference to outdoor temperature	Optionally, the setpoint temperature limit can be enabled here, which is only effective in cooling operation. If necessary, the controller limits the setpoint temperature to specific values and prevents an adjustment beyond the limits. "Only difference to outdoor temperature" setting, the outdoor temperature is monitored and compared to the active setpoint temperature in this setting. The specification of the maximum temperature difference to the outdoor temperature is made using the "Difference to outdoor temperature in cooling mode" parameter. If the outdoor temperature rises above 32 °C, then the controller activates the setpoint temperature limit. It then permanently monitors the outdoor temperature and raises the setpoint temperature so that is beneath the outdoor temperature by the amount configured. Should the outdoor temperature continue rise, the controller raises the setpoint temperature until the required difference to the outdoor temperature is achieved, or, at most, the heat protection temperature. It is then not possible to undershoot the raised setpoint, e.g. by changing the basic setpoint change. The change to the setpoint temperature limit is temporary. It only applies for as long as the outdoor temperature exceeds 32 °C. "Only max. setpoint temperature" setting: In this setting, no setpoint temperatures are permitted in Cooling mode related to the Comfort, Standby and Night modes, which are greater than the maximum setpoints configured in the ETS. The maximum temperature setpoint is specified by the "Max. setpoint temperature in cooling operation" parameter. With an active limit, no larger setpoint can be set in cooling operation, e.g. by a basic

		setpoint change or a setpoint shift. However, heat protection is not influenced by the setpoint temperature limit.
		"Max. setpoint temperature and difference to outdoor temperature" setting: This setting is a combination of the two above-mentioned settings. In the downward direction, the setpoint temperature is limited by the maximum outdoor temperature difference, whilst in the upward direction, the limit is made by the maximum setpoint. The maximum setpoint temperature has priority over the outdoor temperature difference. This means that the controller keeps on raising the setpoint temperature upwards according to the difference to the outdoor temperature configured in the ETS until the maximum setpoint temperature or the heat protection temperature is exceeded. Then the setpoint is limited to the maximum value.
Activation of the setpoint temperature limit in cooling operation via object	No Yes	A setpoint limit enabled in the ETS can be activated or deactivated as necessary using a 1-bit object. For this, this parameter can be set to "Yes". In this case, the controller only takes the setpoint limit into account, if it has been enabled via the object "Cooling setpoint temp. limit" ("1" telegram). If the limitation is not enabled ("0" telegram), the cooling setpoint temperatures are not limited. This parameter is visible only if setpoint temperature monitoring is enabled.
Difference to outdoor temperature in cooling operation	1 K ... 15 K, 6 K	This parameter defines the maximum difference between the setpoint temperature in Comfort mode and the outdoor temperature with an active setpoint temperature limit. This parameter is visible only if setpoint temperature monitoring is enabled. However, this is only if the parameter "Setpoint temperature limit in cooling operation" is then set to "Only difference to outdoor temperature" or "Max. setpoint temperature and difference to outdoor temperature".
Max. setpoint temperature in cooling operation	20°C ... 35°C, 26°C	This parameter defines the maximum setpoint temperature in Comfort mode with an active setpoint temperature limit. This parameter is visible only if setpoint temperature monitoring is enabled.

However, this is only if the parameter "Setpoint temperature limit in cooling operation" is then set to "Only max. setpoint temperature" or "Max. setpoint temperature and difference to outdoor temperature".

□ Room temperature control -> Controller general -> Second operating level

"Operating mode" menu visible in the second operating level **Yes**
No

Here, it is possible to specify whether the operating mode change-over shall appear in the menu of the second operating level of the device. In the "Yes" setting, local control of the display buttons can change over the operating mode. In "No", this local change-over is not possible. The menu is then hidden.

"Temperature change" menu visible in the second operating level **Yes**
No

Here, it is possible to specify whether the setpoint temperature change shall appear in the menu of the second operating level of the device. In the "Yes" setting, local control of the display buttons can change over to the appropriate submenu. In "No", this local change-over is not possible. The menu is then hidden.

Comfort mode temperature change (heating) Disabled
enabled

If the temperature change menu is enabled, it is possible to specify here whether the setpoint temperature for the Comfort heating mode can be set using local control ("Enabled" setting) or not ("Disabled" setting). However, if the function is disabled, the setpoint temperature can only be read off in the menu but not changed. Only visible in "Heating" or "Heating and cooling" operating modes (if necessary with additional levels). In this configuration, the basic setpoint is changed by the comfort value for heating.

Comfort mode temperature change (cooling) Disabled
enabled

If the temperature change menu is enabled, it is possible to specify here whether the setpoint temperature for the Comfort cooling mode can be set using local control ("Enabled" setting) or not ("Disabled" setting). However, if the function is disabled, the setpoint temperature can only be read off in the menu but not changed. Only visible in "Cooling" operating mode (if necessary with additional levels). In this configuration, the basic setpoint is changed by the comfort value for

cooling.

Comfort mode temperature / deadband shift change (cooling)	Disabled enabled	If the temperature change menu is enabled, it is possible to specify here whether the setpoint temperature for the Comfort cooling mode can be set using local control ("Enabled" setting) or not ("Disabled" setting). However, if the function is disabled, the setpoint temperature can only be read off in the menu but not changed. Only visible in "Heating and cooling" operating mode (if necessary with additional levels). In this configuration, the deadband shift is changed by the comfort value for cooling.
Standby operating mode temperature change (heating)	Disabled enabled	If the temperature change menu is enabled, it is possible to specify here whether the setpoint temperature for the Standby heating operating mode can be set using local control ("Enabled" setting) or not ("Disabled" setting). However, if the function is disabled, the setpoint temperature can only be read off in the menu but not changed. Only visible in "Heating" or "Heating and cooling" operating modes (if necessary with additional levels).
Standby operating mode temperature change (cooling)	Disabled enabled	If the temperature change menu is enabled, it is possible to specify here whether the setpoint temperature for the Standby cooling operating mode can be set using local control ("Enabled" setting) or not ("Disabled" setting). However, if the function is disabled, the setpoint temperature can only be read off in the menu but not changed. Only visible in "Cooling" or "Heating and cooling" operating modes (if necessary with additional levels).
Night mode temperature change (heating)	Disabled enabled	If the temperature change menu is enabled, it is possible to specify here whether the setpoint temperature for the Night heating operating mode can be set using local control ("Enabled" setting) or not ("Disabled" setting). However, if the function is disabled, the setpoint temperature can only be read off in the menu but not changed. Only visible in "Heating" or "Heating and cooling" operating modes (if necessary

with additional levels).

Night mode temperature change (cooling) Disabled
enabled

If the temperature change menu is enabled, it is possible to specify here whether the setpoint temperature for the Night cooling operating mode can be set using local control ("Enabled" setting) or not ("Disabled" setting). However, if the function is disabled, the setpoint temperature can only be read off in the menu but not changed.
Only visible in "Cooling" or "Heating and cooling" operating modes (if necessary with additional levels).

☐ Room temperature control -> Controller functionality

Presence detection **Presence button**
Motion detector

In the "Presence button" setting, presence detection takes place using a button on the device or via the presence object (e.g. other push button sensors). When the presence button is pressed, the comfort extension is activated. In the "Motion detector" setting, presence detection takes place using an external motion detector, coupled to the presence object. Comfort mode is recalled when a presence is detected. Comfort mode remains active until the motion detector ceases to detect movement. In this setting, a presence button on the device has no function.

Length of the comfort extension
(0 .. 255) * 1 min;
0 = OFF 0 ... 255, **30**

When the presence button is pressed, the controller switches to Comfort mode for the length of time specified here. When this time has elapsed, it switches back automatically. In the "0" setting, the comfort extension is switched off, meaning that it cannot be activated from Night or Frost/heat protection mode. In this case, the operating mode will not be changed, although the presence function has been activated.
This parameter is only visible when presence detection is configured to "Presence button".

Switch off controller (dew point operation) **No**
via bus

This parameter enables the "Disable controller" object. If the controller is disabled, there is no feedback control until enabled (command values = 0). An activated controller disable (dew point operation) is shown in the display.

Valve protection

No
Yes

Valve protection may be carried out periodically in order to prevent the addressed control valves of the heater or cooling system from becoming calcified or stuck. The "Yes" setting in this parameter activates valve protection.

This type of protection is generally started not only for non-active command value outputs, i.e. for outputs which have not requested any heating or cooling energy over the past 24 hours. For these outputs, the controller will periodically set the command value to the maximum value once a day for a duration of approx. 5 minutes.

4.2.5.4 Parameters for the display

Description	Values	Comment
□↵ Display		
Backlighting	<p>Always off</p> <p>always On</p> <p>Switch on through button-press</p> <p>switching object Inverted switching object</p> <p>Switch on through button-press or switching object</p> <p>Switch on through button-press or inv. switching object</p>	<p>The backlighting can be permanently on or off or alternatively be switched according to events. If the lighting is switched on by pressing a sensor area, the device switches the lighting off automatically when the switch-off time configured in the ETS elapses. The switch-off time is retriggered by each sensor area operation- When the backlighting is switched by the communication object, the lighting remains switched on according to the switching value (not inverted: "0" = OFF / "1" = ON; inverted: "0" = ON / "1" = OFF).</p> <p>Lighting activation by operating a sensor area can be combined with switching via the object. In this case, lighting is switched on automatically when a sensor area is actuated and switched off against after the switch-off time configured in the ETS has elapsed. In addition, the lighting can also be switched by the communication, independently of operation on the device. In this case, the lighting is no longer switched off automatically when the time has elapsed. The switch-off can then only take place using a switch-off telegram in accordance with the normal or inverted telegram polarity.</p>
Automatic switch-off after	<p>15 sec</p> <p>30 sec</p> <p>45 sec</p> <p>1.0 min</p> <p>1.5 min</p> <p>...</p> <p>1 h</p>	<p>The backlighting of the display is switched off automatically after the time set here, if it has been switched on by a button-press.</p> <p>This parameter is only visible when the backlighting is to be switched on by button-press.</p>
Number of pieces of display information	<p>1 display information</p> <p>2 pieces of display information</p> <p>3 pieces of display information</p> <p>4 pieces of display information</p>	<p>In addition to the icons, it is possible to use the numeric display to show up to four display functions in the display. This means that is possible to indicate the time and day, the setpoint temperature, the actual temperature or the outdoor temperature.</p> <p>It is possible to configure which of this information is actually shown in the display using this parameter. For each piece of display information, additional parameter nodes are then shown in the ETS.</p>

Cyclical changeover of display information (1 ... 60 s)	1 ... 60, 5	This parameter specifies after how long a changeover of display information takes place on the display. The cyclical changeover only applies to display information included in the changeover. Inclusion is carried out using the parameters of the appropriate display function. This parameter is only visible if more than one piece of display information is enabled.
Recall display information	No recall Via switching object Via value object (1-byte)	In addition to the changeover by time, the information indication can also be controlled by a communication object. This parameter can be used to enable the recall object and specify its data format. With recall by a 1-bit switching object, it is also possible to define in the ETS which display information should be displayed with object control. When recalled using a 1-byte value object, the received telegram value immediately specifies the display information to be recalled. Any piece of information defined in the ETS can be recalled with a value of "1" to "4". If the opened page is not planned or a value is received, which cannot be assigned to any piece of information, then the telegram is ignored. This parameter is only visible if more than one piece of display information is enabled.
Display information via switching object	Indication 1 Indication 2 Indication 3 Indication 4 (The indication selection is dynamically adjusted by the ETS according to the enabled display information).	Here, it is possible to specify the display information to be recalled using the switching object. This parameter is only visible if more than one piece of display information is enabled and the "Recall display information" is set to "Via switching object".
<input type="checkbox"/> Display -> Indication 1 Indication X with cyclical changeover x = 1, 2, 3, 4	No Yes	This parameter specifies whether the display information is to be included in the cyclical changeover ("Yes" setting). Display information 1 is always included in the cyclical changeover.

Display information 1	Time	Here, it is possible to select which piece of information is to be Indicated on the display. This parameter presetting depends on the selected display information.
	Setpoint temperature	
	Actual temperature (room temperature)	
	Outdoor temperature	

□← Display -> Indications 2, 3, 4 (see Indication 1)

4.2.5.5 Parameter on scene function

Description	Values	Comment
<input type="checkbox"/> Scene		
Scene function ?	Yes No	The device can internally handle eight scenes with eight actuator groups. This parameter activates the scene function and the other parameters and communication objects, if needed.
Overwrite scene values during ETS download	Yes No	If the values of the actuator groups that have been changed on site by the used are to be reset to the values preset in the ETS during an application download by the ETS, the setting "Yes" must be chosen. If "No" is selected, the ETS values will not overwrite the scene values stored in the push button sensor, if any.
Scene 1 Recall via extension object with scene number	1 ... 64	If the internal scenes are to be recalled via the extension object, a definite number is required for each of them. This parameter serves to specify the extension number of the first scene.
Scene 2 Recall via extension object with scene number	2 ... 64	If the internal scenes are to be recalled via the extension object, a definite number is required for each of them. This parameter serves to specify the extension number of the second scene.
Scene 3 Recall via extension object with scene number	3 ... 64	If the internal scenes are to be recalled via the extension object, a definite number is required for each of them. This parameter serves to specify the extension number of the third scene.
Scene 4 Recall via extension object with scene number	4 ... 64	If the internal scenes are to be recalled via the extension object, a definite number is required for each of them. This parameter serves to specify the extension number of the fourth scene.
Scene 5 Recall via extension object with scene number	5 ... 64	If the internal scenes are to be recalled via the extension object, a definite number is required for each of them. This parameter serves to specify the extension number of the fifth scene.

Scene 6 Recall via extension object with scene number	6 ... 64	If the internal scenes are to be recalled via the extension object, a definite number is required for each of them. This parameter serves to specify the extension number of the sixth scene.
Scene 7 Recall via extension object with scene number	7 ... 64	If the internal scenes are to be recalled via the extension object, a definite number is required for each of them. This parameter serves to specify the extension number of the seventh scene.
Scene 8 Recall via extension object with scene number	8 ... 64	If the internal scenes are to be recalled via the extension object, a definite number is required for each of them. This parameter serves to specify the extension number of the eighth scene.
<input type="checkbox"/> Scene output 1		
Data type	Switching Value (0 ... 255) Value / position of Venetian blind (0 ... 100%)	Selection of the data format of the scene output.
Scene 1 Switching command	ON OFF	The switching command of the first scene can be predefined here. This parameter is only visible if "Data type = Switching".
Scene 1 Value (0 ... 255)	0 ... 255	The value of the first scene can be predefined here. This parameter is only visible if "Data type = Value (0...255)".
Scene 1 Value / position of Venetian blind (0 ... 100 %)	0 ... 100	The value of the first scene can be predefined here. This parameter is only visible if "Data type = Value / Venetian blind (0...100%)".
Scene 1 Allow save?	Yes No	If the user is to be given the possibility of changing the value of the scene and of storing it while the system is running, this parameter must be set to "Yes".
Scene 1 Allow transmission?	Yes No	If the state of an actuator group is to remain unchanged during the recall of a scene, this parameter can be set to "No". In this case, the push button

5 Appendix

5.1 Index

"	Dismantling.....	13
"Heating and cooling" mixed operating mode	Display.....	166
2	Display information.....	167
2-point feedback control.....	Display reading change-over.....	170
A	E	
Adapting 2-point control.....	ETS search paths.....	28
Adapting the PI control.....	F	
Alarm signal.....	Fan controller automatic operation.....	144
B	Fan controller command value limiting values ..	148
Backlighting.....	Fan controller command value offset... ..	148
Basic display.....	Fan controller fan level limit.....	147
Basic setpoint.....	Fan controller fan protection.....	149
Basic setpoint shift.....	Fan controller forced fan position.....	148
Button function.....	Fan controller manual operation.....	144
C	Fan controller operating mode.....	143
Cleaning function.....	Fan controller switch-on level.....	146
comfort extension.....	Full-surface operation.....	67
Comfort extension.....	H	
Command value objects.....	Heating/cooling message.....	96
Command values automatic transmitting ..	I	
Control algorithms.....	Icons	166
Controller extension.....	M	
Controller extension display fan levels..	Main menu.....	19
Controller extension display heating/cooling ..	O	
Controller extension display operating mode ..	Operating mode.....	22
Controller extension display setpoint shift ..	Operating mode switchover.....	85-86
Controller extension functionality.....	Operating modes.....	94, 108
Controller extension objects.....	Operation concept.....	65
Controller extension operating mode switchover ..	Operation mode after reset.....	116
Controller extension presence button..	P	
Controller extension room temperature measurement ..	PI control continuous.....	98
Controller extension setpoint shift.....	PI control switching.....	98
Controller status.....	Presence function.....	115
Controller status addition.....	R	
D	Rocker function.....	66
Delivery state.....	Room temperature measurement basic principles ..	131
Disabling function.....	S	
Disabling functions controller.....	Scene control.....	162
	Scene definition.....	162

Scene recall.....	162
Scope of functions.....	29
Second operating level.....	19
Sensor connection external.....	131
Setpoint temperature limit for cooling...	125
Setpoint temperatures.....	23
Setpoint temperatures ETS presetting..	124
Setpoint temperatures overview.....	117
Single operating modes.....	94
Status LED.....	87
Storing scenes.....	163
T	
Temperature adjustment.....	128
Temperature detection.....	133
Temperature detection calibration.....	135
Transmit actual temperature.....	135
Transmitting the setpoint temperature..	130
U	
Underfloor heating temperature limit....	136
V	
Valve protection.....	151
Version of application program.....	32
W	
Window status.....	116

Berker GmbH & Co. KG
Klagebach 38
58579 Schalksmühle/Germany
Telefon + 49 (0) 2355/905-0
Telefax + 49 (0) 2355/905-111
www.berker.de