

## Radio timer quicklink

Order no. 8574 52 xx

### Operating instructions

#### 1. Safety instructions

Electrical equipment may only be installed and assembled by a qualified electrician in accordance with the relevant installation standards, regulations, directives and safety and accident prevention directives of the country.

Failure to comply with these installation instructions may result in damage to the device, fire or other hazards.

The radio transmission is not suitable for safety or alarm applications.

These instructions are an integral component of the product and must be retained by the end user.

#### 2. Design and layout of the device

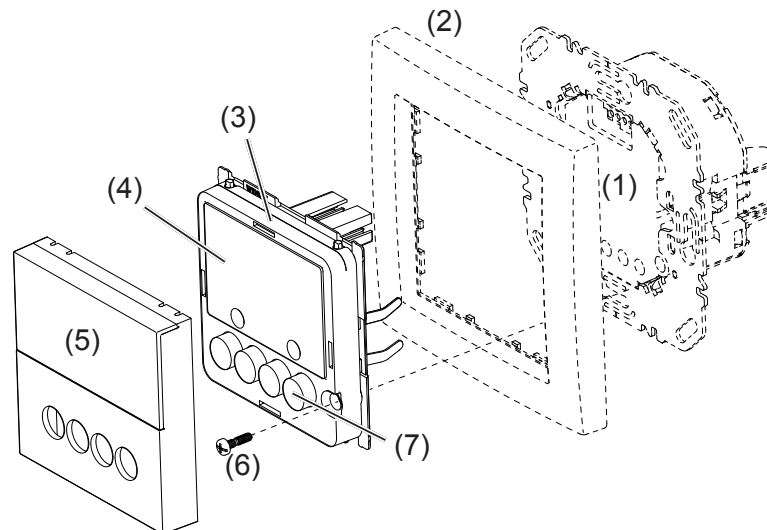

Figure 1: Design and layout of the device

- (1) Insert (see "Accessories", not in scope of delivery)
- (2) Frame (not within scope of delivery)
- (3) Application module
- (4) Display
- (5) Design cover
- (6) Screw for dismantling protection (not for design lines R.1/R.3)
- (7) Operation buttons

### 3. Function

#### System information

This device is a product of the quicklink system, in which installation devices communicate via radio signals.

Quicklink stands for a configuration mode in which the function-related connection between transmitters and receivers is set on the device through buttons and displays without further tools.

All devices configurable by quicklink can be operated together in one system.

#### Correct use

- Application module for relay switch insert or power supply for radio application modules
- Manual, time-controlled or automatic switching of the connected loads
- Transmission and reception of manual, time-controlled and automatic switching commands via quicklink
- Only suitable for use in indoor areas with no drip and no spray water.

#### Product characteristics

- quicklink functions for inclusion in the remote and group control of lighting
- Integration into scenes
- Two preset standard time programmes
- Individual adjustment of the time programmes possible
- Astro programme for automatic switching at dawn/dusk
- Astro time shift to adjust the switching times
- Holiday programme for random switching times in automatic mode
- Party programme to avoid unintentional switching operations through automated switching commands as well as radio/extension commands
- Keylock
- Automatic switching to standard/daylight saving time

#### Performance after mains breakdown/return of mains supply

- Mains breakdown:  
Saving of the current configuration and programming in the non-volatile memory. The device then switches to economy mode. Only the internal clock continues to run to keep the time up-to-date. The use of a buffer memory ensures that the time stays up-to-date for up to 24 hours.
- Return of mains supply:  
The application module executes an initialisation operation<sup>1)</sup>, the basic display is restored. The saved configuration and programming is loaded from the memory. Any operations pending when the power supply broke down will not be executed after return of mains supply.

<sup>1)</sup> When the buffer memory has been used up, the date and time must be re-entered.

### 4. Operation

#### Operating concept and display elements

A short press on the **on** and **off** buttons (Figure 2) switches loads manually, whilst a press > 2 seconds can trigger various functions within the menu operation.

The current clock status is displayed. Active functions are displayed by using symbols (Table 1). Display illumination is activated for as soon as a button is pressed.

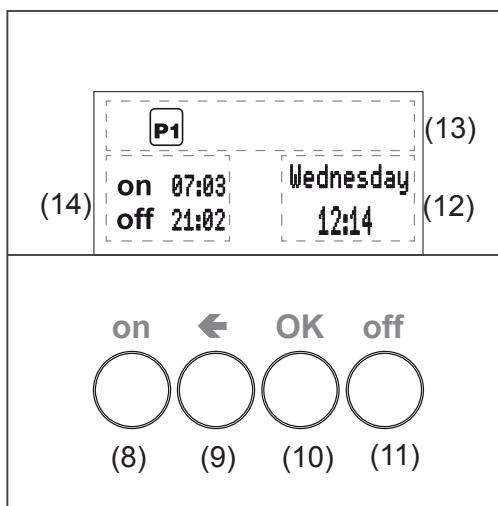

Figure 2: Display and operating elements

- (8) on button
- (9) Back button
- (10) OK button
- (11) off button
- (12) Display of weekday and time
- (13) Display of the active function/programming
- (14) Display of next switching times











Symbol	Function
	Keylock active
	Manual operation, no automatic switching times
	Preset programme <b>P1</b> (week programme) or <b>P2</b> (week/weekend programme) is active
	Astro programme is active, switching times are controlled depending on dawn/dusk times
	Party programme is active, manual operation only. Programmes, extension units and radio commands are not executed
	Normal radio operation is active, radio commands for master or group controls can be transmitted and received.
	Stand-alone operation, Device has temporarily been removed from higher-level master controls, but can still be active as a group control.
	Holiday programme Random variation of switching times, only possible in combination with  ,  or 
Cfg	Device is in radio configuration mode.

Table 1: Symbols in the function/programme line (13) of the display

### Switching - operation from the basic display



Manual operation of the controlled loads is possible at any time from the basic display, even if automatic programmes are active.

- Press the **on** button.  
Load switches ON.
- Press the **off** button.  
Load switches OFF.

### Locking/unlocking operation

The operation buttons of the timer can be locked, in order to prevent unintentional operation, e.g. by children.

The timer is in the basic display.

- Press the **←** button for more than 5 seconds.  
 is displayed. The operation buttons are locked.
- Press the **←** button again for more than 5 seconds.  
 disappears in the display. The operation buttons are enabled.

### Opening the menu and navigating

The device is set and programmed via the menu.

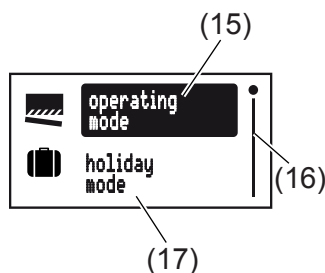



Fig. 3: Main menu

(15) Selected menu item

(16) Position display of the selected menu item in the list of options

(17) Next option in the list

- Briefly press any button.  
Operation is activated. The display is illuminated.
- Press the **OK** button for more than 2 seconds.  
The main menu is displayed. The first menu item **operating mode** (fig. 3, 15) is highlighted dark.
- Press the **on** (↑) or **off** (↓) button to navigate through the menu.  
The selected menu item is highlighted dark.
- Confirm the selected option by pressing **OK**.  
The submenu opens.
-  Navigation through the menus can continue as described above.
- Press the **←** button.  
The display switches to the previous contents. To return to the basic display, press the **←** button multiple times as necessary.

**i** If no button is pressed for a period of two minutes, the display returns to the basic display. The following diagram shows an overview of the functions in the menus/submenus: **A..** for the user and **E..** for the electrician refer to sections for additional information. Menu items in brackets are visible depending on the timer programming status.

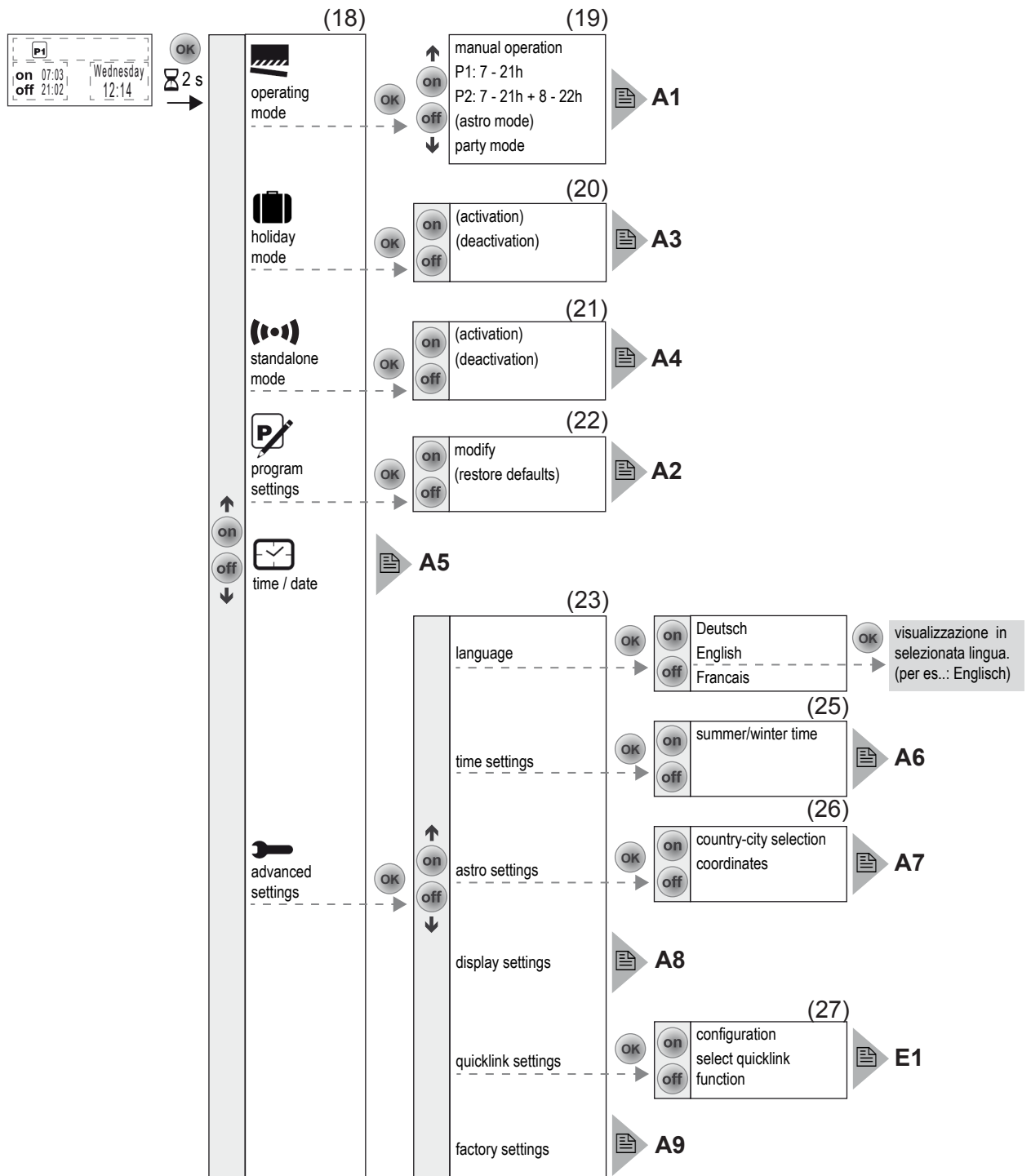
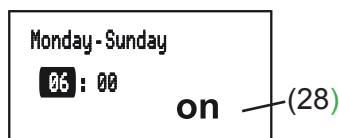

Figure 4: Menu overview

## Setting the values

Values, such as time or date, have to be set first for the programming of some functions. The value to be set is selected and is highlighted dark.

- Press the **on** (↑) or **off** (↓) button.  
Short button-press: change the value by one step.  
Keep button pressed: Scroll through values. Scrolling stops when the button is released.



- If switching times are set, then a symbol (28) shows whether it is an ON or OFF switching time.
- Press the **OK** button.  
The set value is applied.
- Press the **←** button.  
The display switches to the previous value. The setting is not applied.

## Submenu A1 - Select programme

One can choose between the following programmes:

- **manual operation:**  
Operation takes place solely using the buttons (see Switching - operation from the basic display).
- Time programmes **P1: 7 - 21 h** and **P2: 7 - 21 h + 8 - 22 h** :  
These programmes are factory preset but can be changed individually.  
**P1** is a week programme with identical switching times for each day, **P2** is a week/weekend programme with different switching times for Mon. - Fri. and Sat. - Sun.
- **astro mode:**  
Programme for dawn/dusk-dependent control of the loads (see submenu A7 - Setup Astro programme).
- The **astro mode** is only displayed if it has been set up.
- **party mode:**  
The Party function prevents unintentional switching of the connected loads by programmed switching times or extension unit operation, e.g. switching patio lighting OFF during a barbecue.
- When the Party programme is active, a load can only be operated manually using the buttons on the timer. Control via high-level control-sections and sensors as well as by extension units, radio and forced control commands is deactivated.  
If the load is moved to a defined state in **forced mode** (see table 4) and this forced mode is active, then the Party programme cannot be selected and the following message appears in the display: **Party mode not available in forced mode:**

The device shows the Programme selection submenu (Fig. 4, 18). The most recently selected programme is highlighted dark.

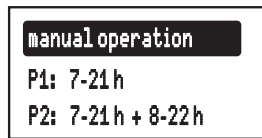

- Press **on** (↑) or **off** (↓) button to select the desired programme.
- Press the **OK** button.

The screen switches to the basic display. The selected programme is run, the corresponding symbol (Table 1) is shown in the display (Fig. 2, 13).

### Submenu A2 - Change, delete or add to programmes

The options **modify** resp. **restore defaults** (figure 4, 22) can be used for the preset factory programmes:

- **modify** to adapt, add to or delete switching times. A maximum of 20 switching times per day are possible.
- **restore defaults** to reset a modified programme to the factory default programming.
-  Switching times can only be edited individually under **modify**. It is not possible to edit programme blocks (e.g. Mon. - Fri.).
- Press the **on** or **off** button to select options or to change the values.
- Press the **OK** button.

Short press on button: Confirmation of the current selection or the set value.

Long press on button (> 2 s) in programme editing: Adding an extra switching time or deletion of an existing switching time.



- Press the ← button.

Short press on button: The display switches to the last content.

Long press on button (> 2 s): Programming is completed, the switching times are skipped. Changes can be saved or rejected.

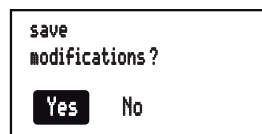

-  Should no OFF switching time follow an ON switching time, or vice-versa, then the user is informed on the display before saving, that switching times are missing. Saving is nevertheless possible.

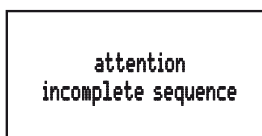

### Submenu A3 - Activating/deactivating Holiday programme

The Holiday programme is a simple form of the presence simulation. The switching times of an existing programme (P1, P2, Astro) are varied, randomly, by  $\pm 15$  minutes. If switching times are too close together (difference  $< 15$  minutes), then they are not varied.

The time switch can be found in the submenu **holiday mode** (figure 4, 20).

- Confirm **activation** with **OK**.

The screen switches to the basic display and the symbol  for **holiday mode** is displayed (figure 2, 13).

or:

- Confirm **deactivation** with **OK**.

The screen switches to the basic display and the symbol  for **holiday mode** is hidden in the display.

### Submenu A4 - Activating/deactivating Stand-alone programme

The Stand-alone programme can be used for radio installations, in which the time switch was assigned to a master controller as a subordinate controller. In Stand-alone operation the device ignores the radio commands of higher-level master controls and forced control commands, as well as extension unit signals, i.e. switching commands concerning the local load are not executed.

-  If the load is moved to a defined position in **forced mode** (see table 4) and this forced mode is active, then the Stand-alone programme cannot be selected. The message **Standalone mode not available in forced mode** appears briefly in the display.

The time switch can be found in the submenu **standalone mode** (figure 4, 21).

- Confirm **activation** with **OK**.

The screen switches to the basic display and the symbol  for **standalone mode** is displayed (figure 2, 13).

or:

- Confirm **deactivation** with **OK**.

The screen switches to the basic display and the symbol  for normal radio operation is displayed (Fig. 2, 13).

### Submenu A5 - Set time/date

In the main menu (figure 4, 18) **time/date** is highlighted dark.

- Briefly press the **OK** button.

The hour display as an active element is highlighted dark.

- Set the date and time (see Setting values).

When all the setting options have been run through, the screen returns to the basic display.

### Submenu A6 - Set time options

The automatic switching to standard/daylight saving time can be activated or deactivated for the timer.

The submenu **time settings** is displayed (figure 4, 25).

- Confirm option **summer/winter time** with **OK**.



- Press the buttons **on** or **off** to select the required setting and confirm by pressing **OK**.  
The device applies the setting and returns to the submenu **time settings**.



### Submenu A7 - Setup Astro programme

The Astro function causes controlled loads to be switched at dawn and dusk, meaning that the switching times are adjusted automatically according to the season. One can choose ON or OFF switching operations for dawn and dusk. As these switching times can be very early or very late, the Astro function offers enhanced options in order to adapt them.

- Deviation from dawn time by  $\pm 120$  minutes
- Deviation from dusk time by  $\pm 120$  minutes
- Früheste EIN-/AUS-Schaltzeit (**earliest on/off time**)  
No switching times are executed before the earliest ON/OFF switching time, as defined by dawn. The lighting is switched off at the set time. Later Astro switching times are executed normally.

Example:

Set time <b>earliest off time</b>	Sunrise	Executed OFF switching time
06:15	07:32	07:32
	05:23	06:15

- Latest ON/OFF switching time (**latest on/off time**)  
No switching times are executed after the latest ON/OFF switching time, as defined by dusk. The lighting is switched on at the set time. Earlier Astro switching times are executed normally.

Example:

Set time <b>latest on time</b>	Sundown	Executed ON switching time
20:00	17:45	17:45
	21:12	20:00

The installation location must be set to determine the correct Astro times.

- Country/city selection:  
Simple setting option by selecting a country and a city near the location from a comprehensive list of European cities.
- The setting is made by entering the geographic co-ordinates and time zone of the location.
-  If the location is outside Europe or a high level of accuracy is required for the Astro times, then the setting should be made using the co-ordinates.

The submenu **astro settings** is displayed (figure 4, 26).

- Use the buttons **on** or **off** to select the setting type and confirm this by pressing **OK**.  
The country/city selection and the co-ordinate settings are displayed.
- Set the location and times (see Setting values). Run through all the setting options.  
Having confirmed the latest **on/off time** time, a query is displayed.

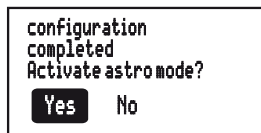

- Press the buttons **on** or **off** to select the required option and confirm this by pressing **OK**.  
**Yes:** The screen switches to the basic display. The Astro programme is run and the appropriate symbol (Table 1) displayed (Figure 2, 13). The Astro settings are saved and Astro is added to the programme selection (Fig. 4, 18).  
**No:** The screen switches to the basic display. The Astro settings are saved and **astro mode** is added to the programme selection (figure. 4, 18), but is not run

**Submenu A8 - Set display contrast**

In the submenu Basic setting (figure 4, 23) **display settings** is highlighted dark.

- Briefly press the **OK** button.

The current contrast value as an active element is highlighted dark.



- Set the contrast (see Setting values).

Having made the setting, the display returns to the Basic setting submenu.

**Submenu A9 - Resetting the device to the factory settings**

- i** In the factory setting, both the user's settings, such as programmes or Astro settings, are reset and all the configured radio logic functions deleted.

In the submenu basic setting **factory settings** is highlighted dark.

- Press the **OK** button for more than 10 seconds.

During initialisation, the display shows ∪ and then switches to Start-up mode. Language, time and date must be reset.

## 5. Information for electricians

### 5.1 Installation and electrical connection

#### Selecting installation location

A minimum distance between the transmitter and corresponding receiver of about 1 m must be maintained.

A minimum distance to electronic devices which emit high frequency signals such as computers, electronic transformers or microwave devices of approx. 0.5 m must be maintained.

Mounting on or close to metal surfaces may cause impairment of the radio transmission.

Take material penetration into account. The range of the system can be optimised by selecting the best possible installation site:

Material	Degree of material penetration
Wood, plaster, plasterboard, uncoated glass	approx. 90 %
Brick, press boards	approx. 70 %
Reinforced concrete, underfloor heating	approx. 30 %
Metal, metal grids, aluminium laminates, coated glass	approx. 10 %
Rain, snow	approx. 1 ... 40 %

Table 2: Material penetration

#### Assembly of the device (Figure 1)

The insert is installed (see operating instructions for the insert).

- Attach the application module (3) together with frame (2) to a suitable insert (1) so that the contact pins are inserted into the available jack.

As soon as voltage is supplied to the application module, the display indicates whether the application module and the insert are compatible with each other:

Display text	Meaning
(Operating mode indicator)	Compatible
Invalid Power Module	Not compatible
Invalid or defect Power Module!	Incompatible or missing supply voltage. Check the insert and replace as necessary.
Changed Power Module / Reset to factory?	Compatible, but not configured to each other. Direct reset of the radio configuration to the factory setting possible by keeping (10 s) the <b>OK</b> button pressed. User settings (e.g. times, programmes) remain set.

Table 3: Insert/application module compatibility

- If available, fix dismantling protection with screw (4).
- Click design cover (5 or 6) into place on application module (3).

### 5.2 Start-up

#### First start-up

The device initialises itself when the mains voltage is switched on for the first time. Insert detection is carried out and, if an incompatible device is found, a message is displayed (see Table 3). Then an hourglass and the manufacturer's logo are displayed.

The language selection is displayed, the first language is highlighted dark.



- Set language, time and date (see Setting values).  
The device switches to the basic display and is ready for operation.

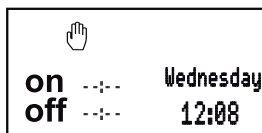

### 5.3 Submenu E1 - Radio configuration quicklink









The radio configuration sets the functional connection between commanding (transmitters) and function-executing (receivers) radio components. In so far wireless e.g. central unit, group, extension unit and time controls can be realised.

The following can be configured:

- The local operation of the load connected to the insert.
  - Radio commands to control other receivers.
  - Functions that are executed when radio commands are received
-  For configuration by means of Hager connection device TX100 or ETS, additional functions are available (see operating instructions for TX100 or application description for ETS).

#### Configuring the radio timer as a receiver







Configuration to control the load connected to the insert via reception of a radio command.

Configurable function		Display text	Effect on the receiver
	ON/OFF	Change-over	A short radio command switches the controlled load alternately ON/OFF
<b>on</b>	Switch ON	Switch-on	A radio command switches the connected load ON.
<b>off</b>	Switch OFF	Switch off	A radio command switches the connected load OFF.
	Scene 1	Scene 1	Creates the switching state saved in the scene (see transmitter instructions). The receiver is allocated to Scene 1 or 2 due to the configuration of the function.
	Scene 2	Scene 2	
	Timer	Time-controlled on	Switches the connected load ON for the set switch-on time. Switch-off takes place automatically when the time has elapsed
	Switch <sup>1)</sup>	On/off (switch)	Device is assigned to a compatible transmitter as a switch. The ON/OFF function is assigned using a teach-in operation.
	Forced mode ON	Forced contr. ON	Switches the load with higher priority to the appropriate switching state. The execution of other commands is only possible after resetting the forced command.
	Forced mode OFF	Forced contr. OFF	
	Delete	Delete	Deletion of the configuration

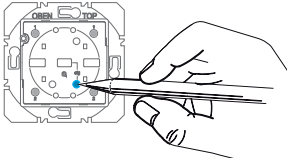
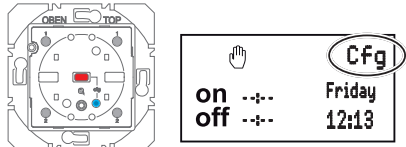
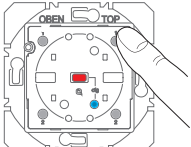
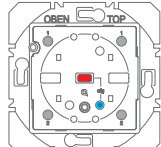
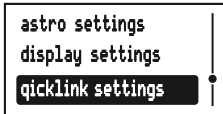
<sup>1)</sup> Preconfigured local function (see operation).

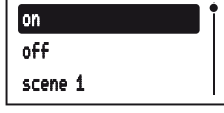
Table 3: Configurable functions

As an example, the configuration of a wall-transmitter and the radio timer as receiver is described down below.

Handling step	Result
<i>Start configuration</i>	
<ul style="list-style-type: none"> <li>Short press on <b>cfg</b> button on the wall transmitter.</li> </ul>  <p><b>i</b> If there is no further activation, the configuration is automatically ended after 10 minutes.</p>	<p>The <b>cfg</b> LED on the wall-transmitter lights up in red colour. <b>Cfg</b> (Table 1) is shown in the display of the timer.</p>  <p>All receivers within radio range also indicate the configuration mode.</p>
<i>Select transmitter button</i>	
<ul style="list-style-type: none"> <li>Short press on press-activation point on the wall-transmitter which should activate the function.</li> </ul> 	<p>The <b>cfg</b> LED on the wall transmitter blinks for 1 second.</p> 
<i>Select function at receiver</i>	
<ul style="list-style-type: none"> <li>Open the <b>quicklink setting</b> menu (see Opening the menu and navigating).</li> </ul> 	
<ul style="list-style-type: none"> <li>Press the buttons <b>on</b> or <b>off</b> <b>select quicklink function</b> and confirm with <b>OK</b>.</li> </ul> 	<p>A list of possible functions is displayed.</p>  <p><b>i</b> If the transmitter button has already been configured with a function in a different receiver and/or the configured function is part of a group control, only this function can be configured. To change a function, the existing configuration needs to be deleted and the new one configured.</p>
<i>Confirming function on receiver</i>	
<ul style="list-style-type: none"> <li>Press the buttons <b>on</b> or <b>off</b> to select the required function and confirm by pressing <b>OK</b>.</li> </ul>	<p>An hourglass displays the logic function operation. The successful execution of the configuration is then displayed.</p> 
<ul style="list-style-type: none"> <li>Confirm the message with <b>OK</b>.</li> </ul>	<p>The menu <b>quicklink setting</b> is displayed. The  symbol indicates that a logic function was set up.</p> 

<p><i>Finish configuration</i></p> <ul style="list-style-type: none"> <li>Short press on <b>cfg</b> button on the wall transmitter again.</li> </ul> 	<p>The <b>cfg</b> LEDs on the radio wall-transmitter and all receivers within radio range go out. The <b>Cfg</b> display on the screen of the radio timer goes out. The function is configured.</p>
--	---

Table 5: Configuring the function for the radio timer

- i** If the message **link error** is displayed during configuration, this indicates an impossible combination or an error. Reset the message by pressing **OK**.



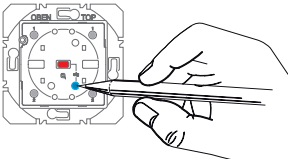
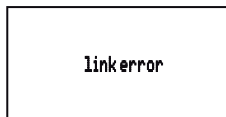

### Configuring radio timer as a transmitter

The following radio command for activation of receiver functions is supported:

**—/— ON/OFF (switch)**

Device is configured as an operator for a compatible receiver. Both buttons are assigned using a teach-in operation. The device serves a master and active timer programmes are also carried out on the receivers.

As an example, the configuration of the radio timer with a radio push-button is shown here. Differing configuration displays, such as for receivers with display, are to be taken from the receiver operating instructions.

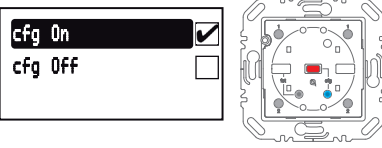
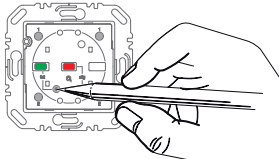
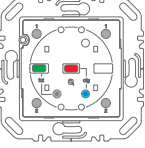
Handling step	Result
<p><i>Start configuration</i></p> <ul style="list-style-type: none"> <li>Open the menu <b>quicklink setting</b> (see Opening menu and navigating).</li> </ul>	
<ul style="list-style-type: none"> <li>Confirm <b>configuration</b> with <b>OK</b>.</li> </ul>	<p>The menu for activating the configuration is displayed. Configuration mode is inactive.</p> 
<ul style="list-style-type: none"> <li>Press the buttons <b>on</b> or <b>off</b> <b>cfg On</b> and confirm with <b>OK</b>.</li> <li><b>i</b> If there is no further activation, the configuration is automatically ended after 10 minutes.</li> </ul>	<p>Configuration mode is active. The <b>cfg</b> LED of the radio button lights up in red colour.</p>  <p>All receivers within radio range also indicate the configuration mode.</p> <p>If configured already, the <b>fct</b> LED of the radio button indicates the configured function.</p>
<p><i>Select function</i></p> <ul style="list-style-type: none"> <li>Select the ON/OFF (switch) function on the radio push-button using the <b>fct</b> button (see operating instructions).</li> </ul> 	<p>The <b>fct</b> LED blinks red and green.</p> 



<p><b>Confirm function</b></p> <ul style="list-style-type: none"> <li>To save the allocation of command and function, keep the <b>fct</b> button of the radio button pressed for more than 2 seconds.</li> </ul> 	<p>The <b>cfg</b> LED blinks. After successful saving, the <b>fct</b> LED blinks red and green.</p>
<p><b>Finish configuration</b></p> <ul style="list-style-type: none"> <li>Press the buttons <b>on</b> or <b>off</b> <b>cfg Off</b> and confirm with <b>OK</b>.</li> </ul>	 <p>The <b>cfg</b> LEDs on the radio button and all receivers within radio range go out. The radio command for the timer has been configured.</p>

Table: Configuring radio timer as a transmitter

### Deleting a configuration

To delete a configured receiver or the local operation, execute the configuration again.

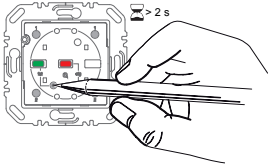
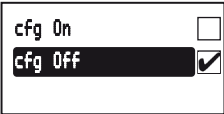
- Start configuration (see configuring the radio timer as a receiver).
- If necessary, *Select transmitter button*.
-  The step *Select transmitter button* does not apply for devices with only one transmission channel, e.g. radio motion detector as a transmitter.
- Select function on receiver.
- Confirm the function on the receiver: press button **on** or **off** to select **delete** and confirm with **OK**.

An hourglass displays the logic function operation. The successful deletion of the logic function is then displayed.

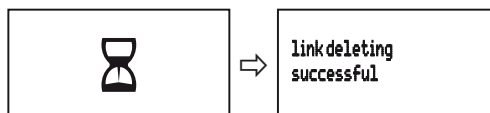

- Confirm the message with **OK**.  
The quicklink setting menu is displayed. The logic function symbol  is removed.



- Finish configuration*: Short press on the **cfg** button the transmitter.

### Configuration of group functions

By means of a group function, one transmitter controls several receivers. To do so, the same functions must be configured on all receivers.

- Start configuration (see configuring the radio timer as a receiver).
- If necessary, *Select transmitter button*.
-  The step *Select transmitter button* does not apply for devices with only one transmission channel, e.g. radio motion detector as a transmitter.
- Select function on receiver: Select the identical function on each receiver to be integrated and confirm the function on the receiver.
- Finish configuration: Short press on the **cfg** button the transmitter.

## Configuration of scenes

Individual settings for lighting and the position of blinds can be combined into scenes. Two different scenes can be created via quicklink and called up by pressing a button on the transmitter. A scene is created by configuring a transmitter button (radio command) in the corresponding receivers with the scene function (Table 4).

- *Start configuration* (see configuring the radio timer as a receiver).
- *Select transmitter button*: Select the button for the scene command.
- *Select function on receiver*: Select the **Scene** function on each receiver to be integrated and *confirm the function on the receiver*.
- *Finish configuration*: Short press on the **cfg** button the transmitter.

## 6. Appendix

### 6.1 Technical data

Radio frequency	868 MHz
Radio protocol	KNX radio
Connection	Mounting on suitable inserts
Power supply	via insert
quicklink logic functions	max. 20 transmitters/receivers
Receiver category	2
Transmitter duty cycle	< 1 %
Power reserve via internal storage battery	24 h
Charging time of the internal storage battery	48 h
Switching times	max. 20 per day/140 in total
Relative humidity (no condensation)	0 ... 65 %
Ambient temperature	-5 ... +45 °C
Storage/transport temperature	-20 ... +60 °C

The Declaration of Conformity can be taken from our Internet site.

### 6.2 Accessories

Relay switch insert	8512 12 0x
Radio power supply	8502 01 0x

### 6.3 Web

Websites to determine the location's latitude/longitude:

- <http://www.active-value.de/geocoder/>
- <http://itouchmap.com/latlong.html>



---

## 6.4 Warranty

We reserve the right to make technical and formal changes to the product in the interest of technical progress.

Our products are under guarantee within the scope of the statutory provisions.

If you have a warranty claim, please contact the point of sale or ship the device postage free with a description of the fault to the appropriate regional representative.