

## Industrial 7 FE/PoE, 1GbE/PoE, 2GbE Managed High Power PoE Switch **JetNet 6910G-M12**



The JetNet 6910G-M12 is new generation power over Ethernet Switch with rugged M12 connectors for IP surveillance in hashed environment, like as Train, MRT and LRV systems. It adapts 8 ports PoE/PSE in 7 ports Fast Ethernet and 1 Gigabit interfaces, and 2 Gigabit interfaces with device fault bypass function. The PSE system enabled 30W high power PoE function and compliance with IEEE 802.3af/at standard. The Switch system also adapts railway electrical power system and supports several types of input voltage rating to correspond different train electrical power system. With above major features, the JetNet 6910G-M12 is helpful to construct IP surveillance network on train with multi-backup features to ensure passenger's safety and train network reliability.



MS / OMS



Heavy Industry



+70  
-40  
Wide Temp



EN50155

### Feature

- ▶ 7 Fast Ethernet M12 D-code , 3 Gigabit M12- X-code , M12-A Power, M12-A Console/USB
- ▶ Rugged M12 Ethernet, Power, Management connector to protect from vibration and shock application
- ▶ 8 IEEE 802.3at PSE allocated in 7 ports Fast Ethernet and 1 Gigabit Ethernet
- ▶ 2 Gigabit Ethernet interfaces support Device Fault Bypass function
- ▶ Railway Power System design with 100W PoE power and compliance with safety requirement
- ▶ Network Redundancy - MSR (Multiple Super Ring),ITU-T G.8032 ERPS, RSTP, MSTP, Super Chain
- ▶ Fully Device Management - SNMP v1/v2c/v3, RMON, Web UI, Telnet and Local Console
- ▶ Friendly Device and Network Topology recovery Utility - Korenix View, Korenix NMS
- ▶ Advanced Network Security -MAC Security, IEEE 802.1x Port Based access control , IEEE 802.1x Radius Server authentication
- ▶ Layer 2 Network Performance - IEEE802.1Q VLAN, Private VLAN, Trunk, Traffic Filtering, DHCP Server/Client, Traffic Prioritize, Forwarding Rate Control
- ▶ Real Hardware Watchdog against internal system malfunction
- ▶ Railway power system - 110V (HVDC model),24V (LVDC model)
- ▶ Railway Standards- EN50155, EN50121-3-2,IEC61373

## Driving the IP Surveillance

The advanced PoE /PSE function enabled remote power feeding capability and compliance with IEEE 802.3af/at with 2-Event and 1-Event-LLDP PoE classification behaviors to ensure the functioning of PoE/PD device. It also offers forced powering technology to active legacy PD device without detection and classification, and fulfill the necessary of PoE IP camera or any PoE/PD device.

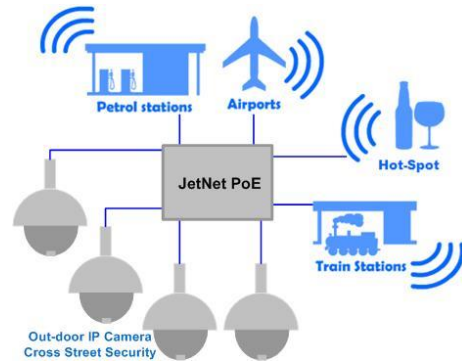

## Rugged M12 Connector Design, Fulfill Transport Application

The electrical equipment design should consider how to provide a reliable communication when it installed on transport system. The JetNet 6910G Switch uses M12 connector with brilliant anti-vibration and shock capability to offer reliable, stable and cost efficiency solution, and it also pass testing- anti-shock/ vibration ensure non-stop communication on the vehicle or rolling stone application.



## Various Wide Range Power Input follow Railway Standard

In the Railway application, the electrical power system should obey EN50155 standard, and supports wide range input with isolated system to offer passenger safety. The JetNet 6910G-M12 system provides various power input specifications - 24V, 37V and 110V. Besides, the 0.7-1.25Un input variation that fully compliance with the specification of railway standard and deliver high reliability, safety, healthy of PoE IP Surveillance solution for on-board application.

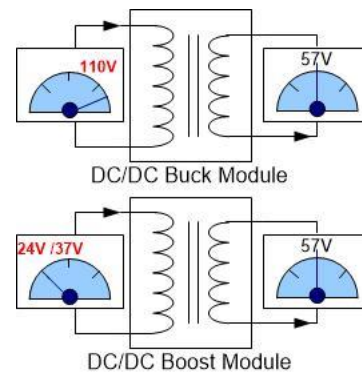

## Anti-Vibration & Shock for long period operating

The Switch system is considered that used in hashed environment present constant, continuous vibration and shock. Therefore, the enclosure housing applied with Nylok screw and assembly with specified torque to prevent any loss under long period of operating. The rigorous production process makes the JetNet Switch could be mounted directly on the car body bear the long period operation.

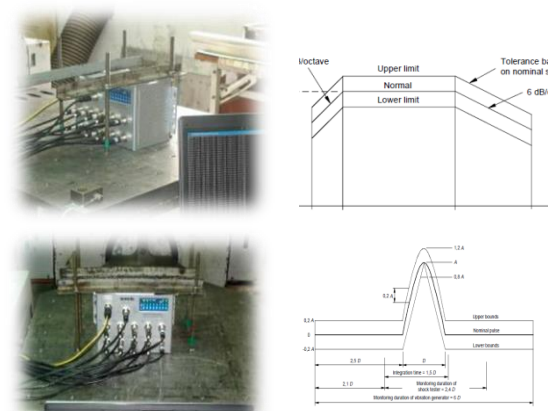

## High Reliability System design with Hardware Watch-Dog Timer

The JetNet 6910G-M12 embedded watch-dog system to meet the inquire of railway rolling stone application. The independent hardware watch-dog timer offers 10 seconds duration to detect system operating status. Once the Switch operating system hanged, the watch-dog system will reset Switch system automatically. The hardware based watch-dog ensured Switch far way software kernel crash after external noise interfere, and keep Switch working well.

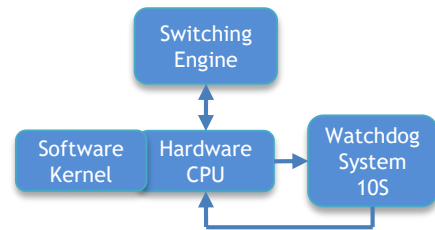

Hardware Watchdog better than Software Watchdog

## Bypass Fault Device in Daisy-Chain or Ring Topology

In the metro or ring network, the topology may fragment and broken into several segments by one node power failure. It results some of segments or nodes can't communicate with each other. The port Bypass function help network far way fragment by link uplink and downlink ports together when Switch power down. With this function, the Switch can ensure train communication always work appropriate.

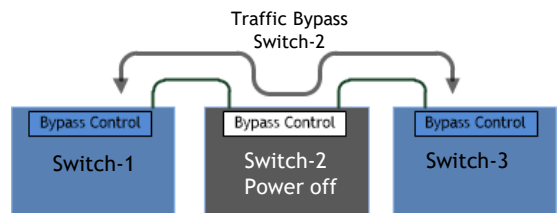

## Friendly System Maintenance

The JetNet 6910G have enabled USB memory access function for system firmware upgrade and configuration restore and backup. The function is useful for the maintenance engineer without special technology. The system kernel will auto upgrade firmware or restore new configuration if new firmware or configuration file existed in the plugged M12/USB memory. It also helps the replacement/exchange very easy and friendly.



RS-232/USB M12-A Connector

M12-A / USB Memory

## Redundant Solution- Multiple Super Ring (MSR™)

The MSR is a seamless network redundant technology, which includes various technologies for different network redundancy topologies and applications. It includes Rapid Super Ring (RSR™), Rapid Dual Homing (RDH™), MultiRing™ and TrunkRing™. With those network redundant technologies, a node can be configured to multiple rings with failover time less than 20ms, and zero of restoration time.

### MSR Multiple Super Ring

#### Rapid Super Ring

- RM Auto-Select
- Seamless Restoration
- mSec Recovery Time
- Failed Ring Port Together with RM
- Ring Failure LED

#### MultiRing

- Ring coupling in one unit
- 4 Gigabit Rings
- 8 Fast Ethernet Rings

#### Rapid Dual Homing

- Multiple Uplink Path
- One to One upper
- Many to One upper
- One to Many upper
- Seamless Restoration

#### TrunkRing

- Active with Port trunk/ LACP with MSR, RSR
- Load Balancing
- Auto Backup

## Rapid Super Ring (RSR™) Technology

The Rapid Super Ring (RSR™) technology provides advanced Ring Redundancy Technology, its shortest recovery time is from 20ms to few mini second for Fast Ethernet copper/fiber rings, and the Ring-Master (R.M.) can be auto-selected by RSR™ engine. One of Ring path of R.M. is primary path, the other is block path for standby. Once the primary path failed, the 2<sup>nd</sup> path will be recovered within few mini second. Besides, the restoration time is shortened to zero in R.M. auto-selection mode.

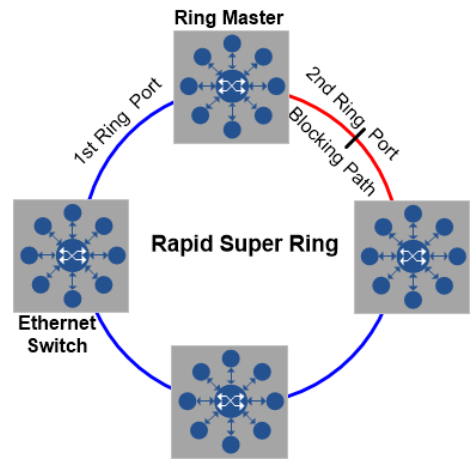

## Rapid Dual Homing (RDH™) Technology

The Rapid Dual Homing (RDH™) is designed to engaged Korenix Rapid Super Ring and other vendors Ethernet Switch. It provides easy configuration and multiple redundancies, the failover time is fast than RSTP, and restoration time is zero. Uplinks can be auto detected, and gathered into groups. Each group path are sorted into primary, secondary, and standby. The Link aggregation is also integrated into RDH™. An uplink can be a single or several links as a trunk , which provides better redundancy and capacity.

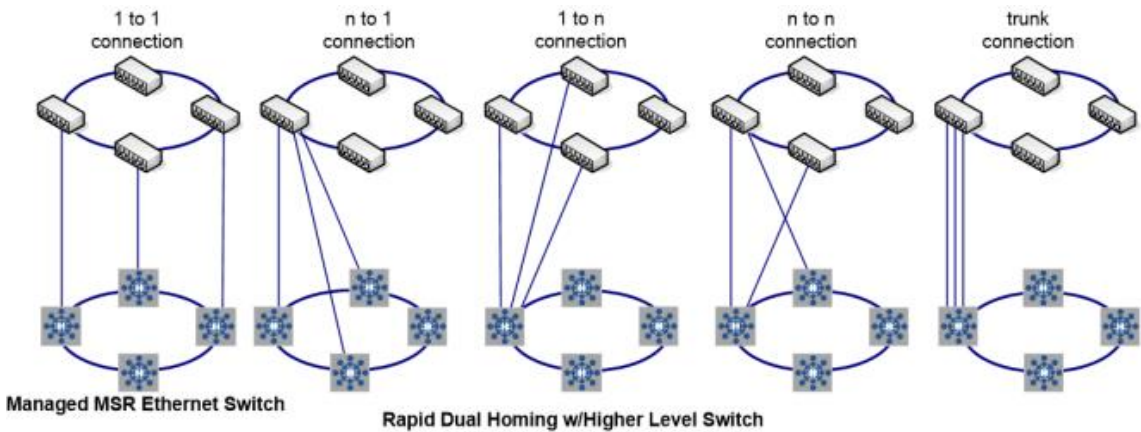

## TrunkRing Technology

The TrunkRing is the combination of two technology of RSR and the link aggregation, and takes the advantage of aggregation to increase the path bandwidth. The ring links can be either asymmetric or symmetric. The ring will open only if all the links are broken, and users can enhance the redundancy at different location in accordance to be the need, the path with less bandwidth is more likely to be used as the backup path for restoring the network to full play capacity.

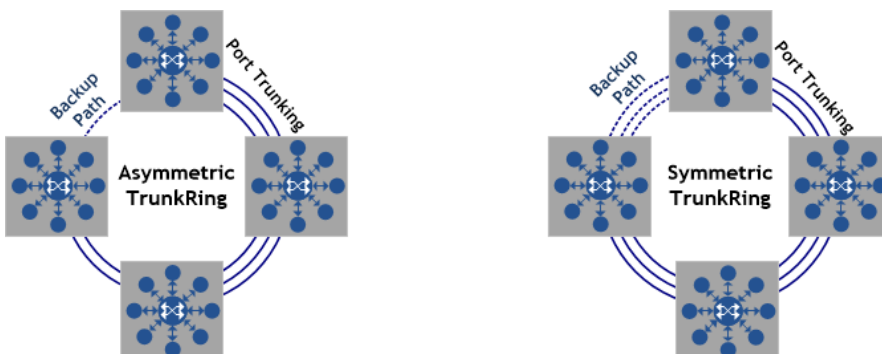

## MultiRing Technology

The MultiRing™ provides easier connectivity between two or more ring networks. The simplest sample is to connect two rings by single device. User can extend the network by linking multiple rings into a line or multiple directions. The MultiRing™ has great diversity of various ring technology, when MultiRing™ enabled, the Switch can connect TrunkRing™, RSR™ together and simultaneously provide more high speed ring connectivity. It provides extensibility while keeping the great compatibility.

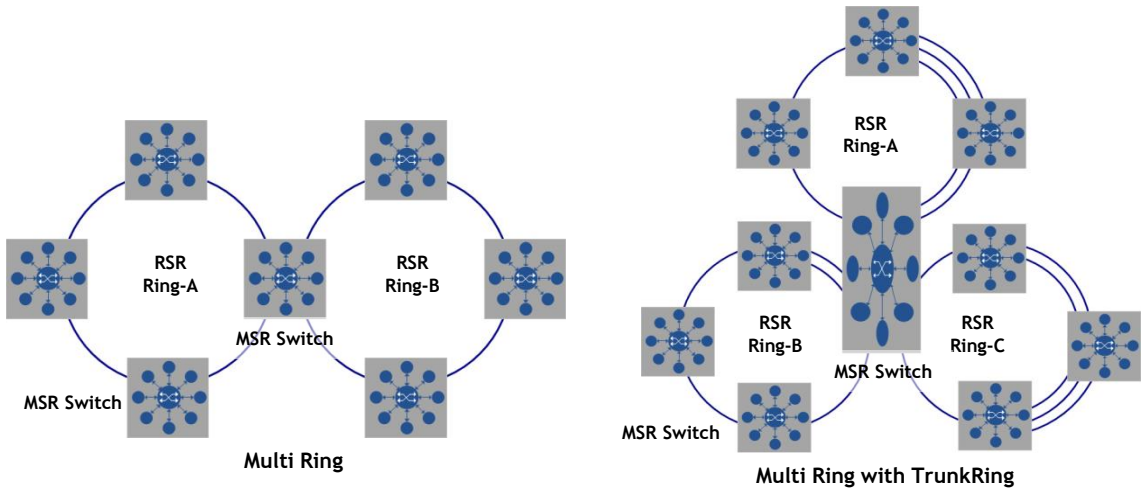

## Super Chain Technology

The Super Chain is a new Ring technology that provides a cost-effective way to ring nodes with presented ring to approached flexible, scalability and easy construction.

The Super Chain includes 2 borders that connect with other ring by edge port, and the reset nodes are member. Once the ring broken, the standby edge port will backup in few mini seconds, and seamless restoration time when the broken path recovery. Besides, users can add new super ring with existed super ring to approach the flexibility to saving the construction cost.

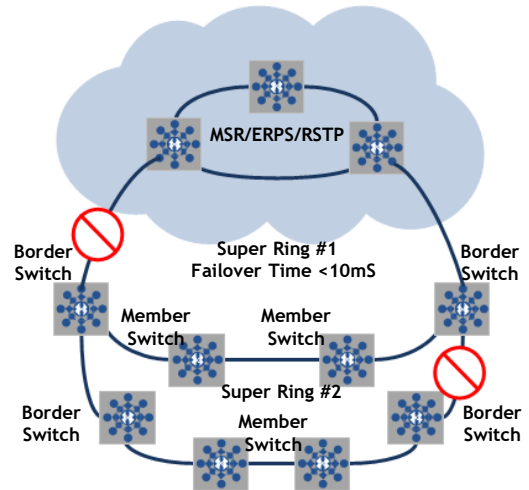

## Seamless Ring Port Restoration

Seamless restoration can restore a failed ring without causing any loop problem, topology change and packet loss. With a zero second restoration time, this mechanism eliminates any unstable status and guarantees the applications running non-stop. It ensure MSR™ Ring can harmonic with RSTP protocol. In the figure, the RM will change to another one which nearby the broken path.

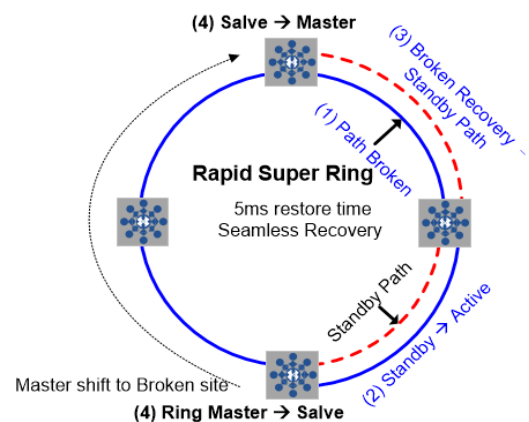

# Specification

Technology	
Standard	IEEE 802.3u 100Base-TX IEEE 802.3ab 1000Base-T IEEE 802.3x Flow Control and Back-pressure IEEE 802.3af Power over Ethernet IEEE 802.3at High power PoE IEEE 802.1AB Link Layer Discovery Protocol (LLDP) IEEE 802.1Q VLAN and GVRP IEEE 802.1D Rapid Spanning Tree Protocol (RSTP) IEEE 802.1s Multiple Spanning Tree Protocol (MSTP) IEEE 802.3ad Link Aggregation Protocol (LACP) IEEE 802.1x Port Based Network Access Protocol
Performance	
Switch Technology	Store and Forward technology with 32Gbps switching fabric
System Throughput	8.3Mega packets per second, 64Bytes packet length
CPU performance	180Mhz ARM-9E /200MIPS performance with 10 seconds hardware based Watch-dog timer
System Memory	8Mega Bytes Flash ROM, 64Mega Bytes RAM
Transfer packet size	64Bytes ~1522Bytes (include double Tag VLAN)
MAC Address	8K MAC address table
Packet Buffer	1Mega bits shared packet buffer
Transfer performance	14,880pps for Ethernet, 148,800 for Fast Ethernet and 1488,100 for Gigabit Ethernet
Management	
Configuration, Monitoring Interface	<ul style="list-style-type: none"> <li>In-Band Management: Telnet with SSH, Web-Browser with SSL, IPv4/IPv6 SNMP V1/V2c/V3 with SNMP Trap (4 Trap Stations), RMON Groups (1,2,3,9)</li> <li>Out-Band Management: Local RS-232 /RJ-45 connector with CISCO like command</li> </ul>
System Manage Secure	<ul style="list-style-type: none"> <li>Telnet/ Local Console support command like interface with Cisco like commands, and offers 4 management sessions only; the system support SSL for HTTP security, SSH for Telnet security</li> <li>Manage station secure by IP address and up to 4 Manage stations</li> <li>Remote Management login authentication by Radius account/password, key for RADIUS Server authentication</li> </ul>
SNMP MIB	MIB II, Bridge MIB, Ethernet Like MIB, VLAN MIB, IGMP MIB, Private MIB
Management Utility	Korenix View and Korenix NMS for device finding and network topology discovery
Network Time Protocol	NTP with daylight saving, localize time synchronize function
IEEE 1588 PTP	IEEE 1588 v1
E-mail Warning	4 receipts E-mail accounts with mail server authentication
System event log	Local and remote log server with authentication
System Auto Maintenance	Power on firmware upgrade, and configuration update by USB/Memory sticker
Network Performance	
Port Configuration	Port Link Speed, Link Mode, Link Status and Port Enable/Disable
Port Trunk/Link Aggregation	IEEE 802.3ad port aggregation and static port trunking, trunk member up to 8 ports, maximum trunk group up to 4 include Gigabit Ethernet port
VLAN	IEEE 802.1Q Tag VLAN with 256 VLAN entries, GVRP supported VLAN Link Modes: Trunk, Hybrid and Link Access
IEEE 802.1 QinQ	Double VLAN Tag with 1522 bytes frame size
Traffic Prioritize	4 physical queues, supports weighted fair queuing (WRR) and strict priority scheme, follows COS tag ID, IPv4 ToS/DiffServ information to prioritize the traffic
Multicasting	IGMP Snooping v1/v2c/v3 for multicasting filtering and forwarding with IGMP Query mode, and also support unknown multicasting forwarding policies- drop, flooding to all ports and forward to router port
Rate Control	Ingress/Egress filtering for Broadcast, Multicast, Unknown DA or all packets

Port Mirroring	Online Traffic monitoring on multiple selected target ports
Port Security	Only permit link partner which with predefined MAC address to access the Ethernet interface
DHCP	DHCP Client/Server with IP & MAC address binding, DHCP Relay Agent function and DHCP Server with static port based IP assigned function
IEEE 802.1x	Port Based Network Access Control with EAPoL to permit or Deny interface access with Remote RADIUS Server authentication
Power over Ethernet	IEEE 802.3af/at, End-Span wiring architecture
PoE operating mode	Auto Mode: IEEE 802.3af/at behaviors with IEEE 802.3at 1-Event for high power IEEE 82.3at 1-event PD device Forced Mode: User configured Power consumption budget control with IEEE 802.3 PoE /PD detection, or forced without PD detection
PoE forwarding conductor	M12 D-Code (Port 1-7): V+(1,3), V- (2,4) / M12 X-Code (Port 8): V+ (1,2), V- (3,4)
Power forwarding capability	IEEE 802.3af:15W, IEEE802.3at:30W
PoE System Power Budget	Power Budget Reserve by PD declaration. The power budget control system will reserve power for connected PD device, once latest PD device (PoE 8) claimed power over the system surplus power, then the latest PoE will not be active. System Power Budget: 100Watts / 70°C
<b>Network Redundancy</b>	
Multiple Super Ring (MSR™)	New generation Korenix Ring Redundancy Technology, Includes Rapid Super Ring, Rapid Dual Homing, TrunkRing™, MultiRing™, Super Chain™ and backward compatible with legacy Super Ring™
Rapid Dual Homing (RDH™)	Multiple uplink paths to one or multiple upper Switch, up to 256 Groups RDH Peer protection
TrunkRing™	Integrate port aggregate function in ring path to get higher throughput ring architecture
MultiRing™	Couple or multiple up to 10 Rapid Super Rings in one device, JetNet 6910G supports up to 5 100M rings or 4 100M rings, 1 1000M ring
Super Chain	It is new ring technology with flexible and scalability, compatibility, and easy configurable. The ring includes 2 types of node Switch - Border Switch and Member Switch
Rapid Spanning Tree	IEEE 802.1D-2004 Rapid Spanning Tree Protocol. Compatible with Legacy Spanning Tree and IEEE 802.1w
Multiple Spanning Tree	IEEE 802.1s Multiple Spanning Tree, each MSTP instance can include one or more VLANs, and also supports multiple RSTP deployed in a VLAN or multiple VLANs
ITU-T G.8032 ERPS	Support ITU-T G.8032 ERPS V1 single ring topology
Loop Protection	The Loop Protection prevents any network looping caused by RSTP and MSR ring topology change
System Fault Bypass	Link Partner Bypass function on Gigabit port 9,10. Both of Gigabit ports will form as inter-connected mode when switch power shut-down or unstable /non-ready
<b>Interface</b>	
Enclosure Port	<ul style="list-style-type: none"> <li>100 Base-TX/100Mbps Fast Ethernet: 7 x M12 D-Code, 4-pin, Female M12-D (Conductor #): (#1) TX+/PoE V+, (#2) RX+/ PoE V-, (#3) TX-/PoE V+, (#4) RX-/ PoE V-</li> <li>1000 Base-T/Gigabit Ethernet (Port #8-#10): 3 x M12-X Code 8-pin Female M12-X (Conductor #): (#1) 0P(DA+)/PoE V+, (#2) 0N(DA-)/PoE V+, (#3)1P(DB+)/PoE V-, (#4)1N(DB-)/PoE V-, (#5)3P(DC+) (#6)3N(DC-), (#7) 2N (DB-), (#8) 2P (DC+)</li> <li>Console &amp; USB: M12 A-Code 8-pin Female for RS-232 and USB 2.0 Host for firmware/configuration update</li> <li>Power: M12 A-Code 4-pin Male</li> </ul>
RS-232 & USB	<ul style="list-style-type: none"> <li>100 Base-TX: 2-pair Cat.5E / Cat.6 FTP/STP cable, EIA/TIA 568B 100-ohm, 100Meters</li> <li>1000 Base-T: 4-pair Cat.5E/Cat.6 FTP/STP cable, EIA/TIA 568B 100Ohm, 100Meters It is recommended uses FTP/STP cable for the railway on-board application</li> </ul> <p>M12 A-Code female 8-pin connector</p> <ul style="list-style-type: none"> <li>RS-232: TxD (Pin-1), RxD (Pin-2), Signal Ground (Pin-3)</li> <li>USB Host: USB-DATA+ (Pin-5),USB-DATA- (Pin-6), USB-5V(Pin-7), USB-GND (Pin-8)</li> </ul>
LED Indicators	<p>100Mbps (Port 1-7): Link (Green on)/Activity (Green Blinking) 1000Mbps (Port 8-10): Link (Green on)/Activity (Green Blinking) PoE (IEEE 802.3af/ Green): Power forwarding (Green on), PoE Detection (Green Blinking) PoE (IEEE 802.3at/ Blue): Power forwarding (Blue on), PoE Detection (Blue Blinking)</p>

Power: System Power Ready (Green on)  
 Sys: System Ready (Green on), System Updating (Green Blinking)  
 R.S.: Ring Normal(Green on)/ Wrong ring port connective(Green blinking), Ring abnormal (Amber on)/ Device's ring port disconnect (Amber blinking)

Power Requirement	
System Power	<ul style="list-style-type: none"> <li>• JetNet 6910G-M12 HVDC Typical Input voltage: DC 110V (Un), Variation voltage 77V (0.7Un)-137.5V (1.25Un)</li> <li>• JetNet 6910G-M12 LVDC Typical Input voltage: DC24V (Un), Variation voltage 16.8V (0.7Un)-30V (1.25Un)</li> </ul>
Power consumption	HVDC: 25Watts (maximum) without PoE/PD loading, DC77-137.5V 125Watts (maximum) with 100W PoE/PD loading, DC77-137.5V  LVDC: 20Watts (maximum) without PoE /PD loading, DC16.8-30V 120Watts (maximum) with 100W PoE/PD loading, DC16.8-30V
Mechanical	
Installation	Wall Mounting
Enclosure Material	Steel Metal with textured paint
Ingress Protection	IP-30
Dimension (mm)	145.2 mm (H) x 198 mm (W) x 120 mm (D)
Environmental	
Operating Environment	-40°C-70°C (100Watts PoE/PD Loading), 0-90%, Non-condensing
Storage Environment	-40°C-80°C, 0-90% Non-Condensing
Hi-Pot	AC 1.2KV for ports-power, power-case
Approvals	
Railway Standard	EN50155, IEC 61373, EN50121-3-2
EMC	EMI: EN50121-3-2/EN50121-1, FCC Class A, IEC/EN61000-6-4 EMS:EN50121-3-2/EN50121-1, IEC/EN61000-6-2 IEC/EN61000-4-2,IEC/EN61000-4-4, IEC/EN61000-4-5, IEC/EN61000-4-6, IEC/EN61000-4-8, IEC/EN61000-4-9
Variation/Shock	IEC 61373
Warranty	5 Years



## Dimension (Unit = mm)

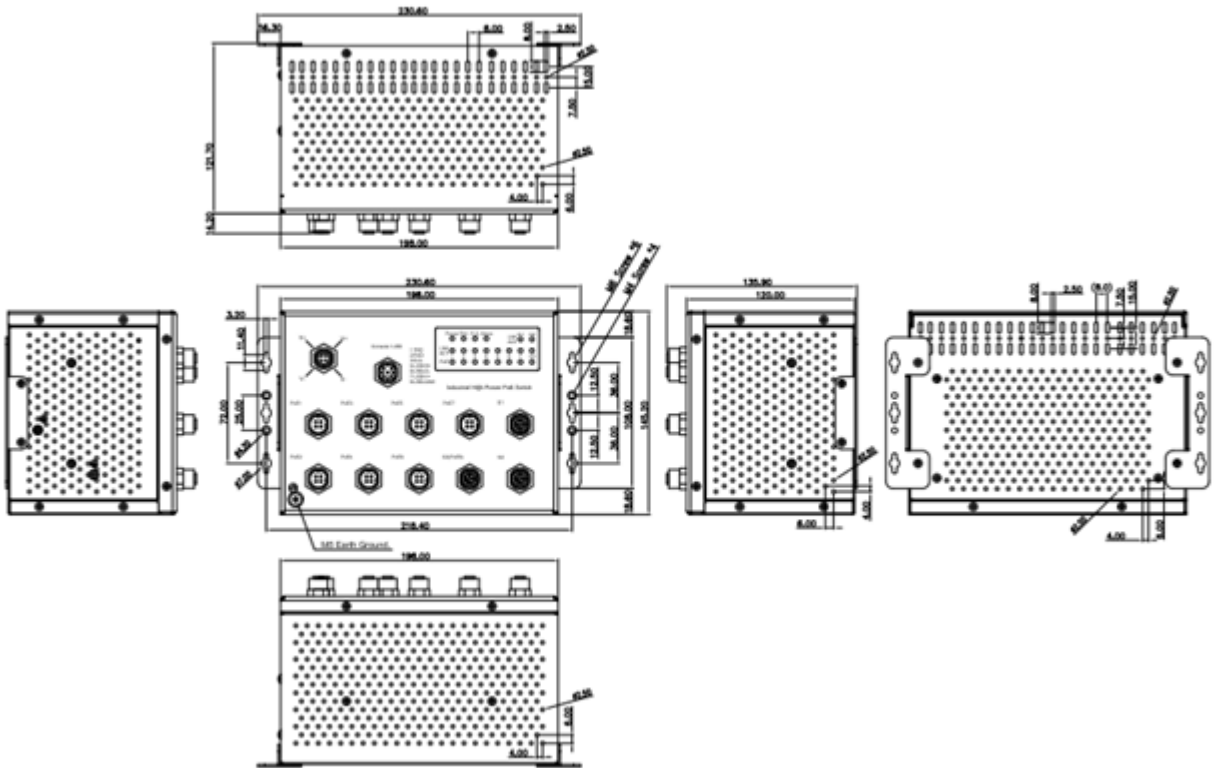

## Ordering Information

JetNet 6910G-M12 HVDC Industrial 10-port M12 Managed PoE Switch, 7 FE/M12-D PoE, 1 GbE/M12-X PoE, 2 GbE/M12-X with Bypass, Typical Power Input DC 110V, -40-70C, 100W PoE

JetNet 6910G-M12 LVDC Industrial 10-port M12 Managed PoE Switch, 7 FE/M12-D PoE, 1 GbE/M12-X PoE, 2 GbE/M12-X with Bypass, Typical Power Input DC 24V, -40-70C, 100W PoE

- Includes
- JetNet 6910G-M12 x1
  - Mounting kits with screws
  - Serial Console cable, RS-232/DB9 to M12-A

Accessory (by option) M12 USB Flash Disk, 4GBytes