

<http://hgr.io/r/hmw630nr>

TRIP UNIT Energy

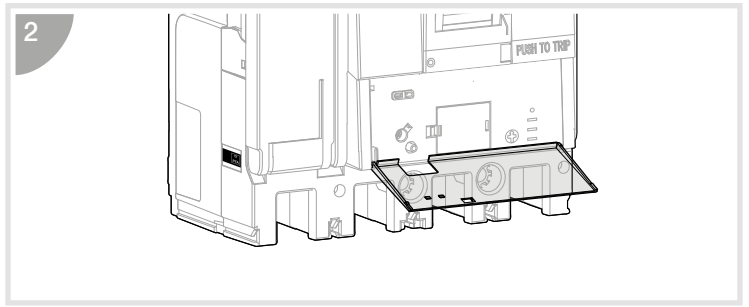
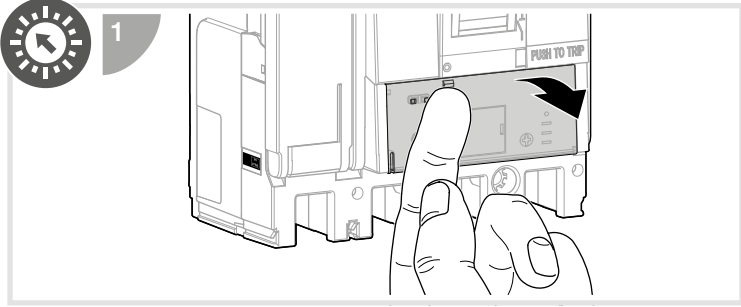

> Ir	<105% Ir	≥ 105% Ir	I > 112% Ir
PTA	PTA OFF	PTA ON	PTA ON PTA OUT ON
Ready	OFF		ON

:hager

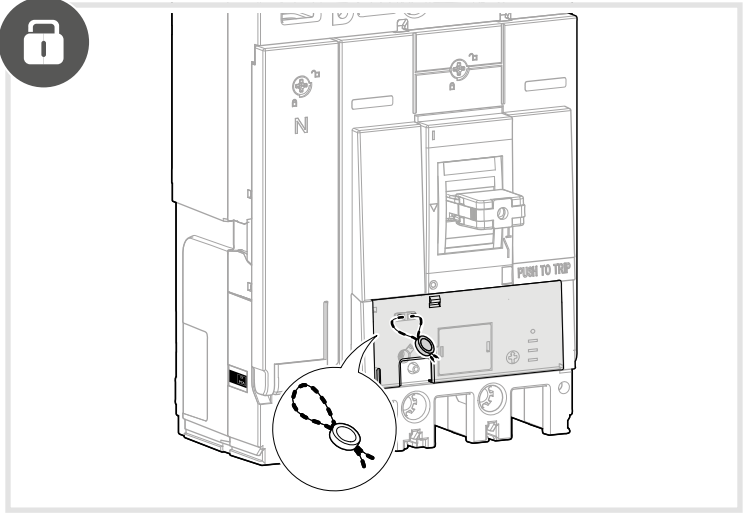
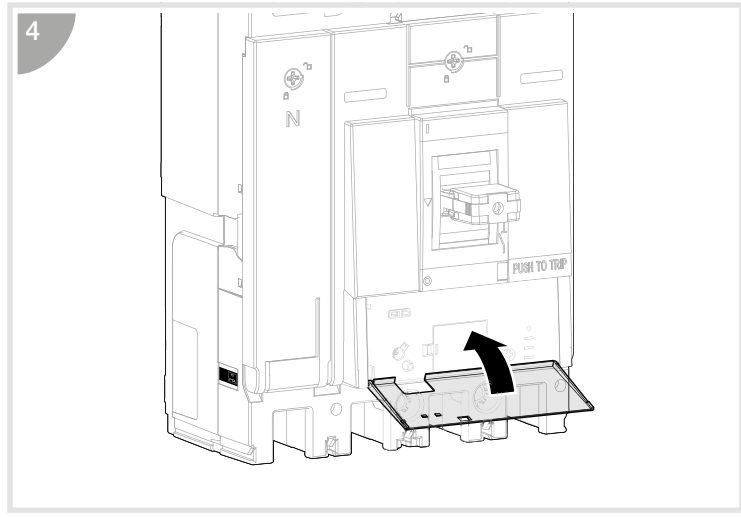
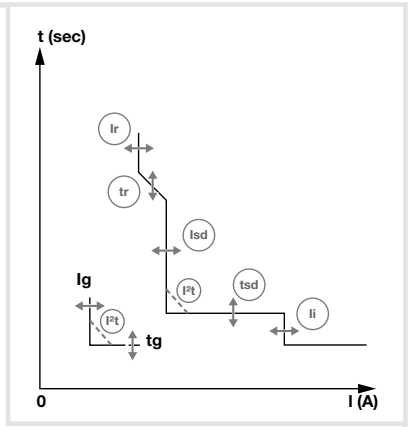

5

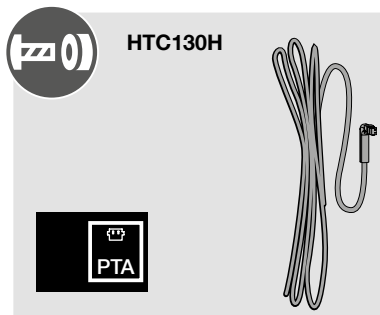
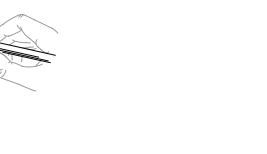
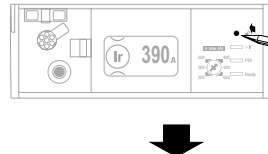
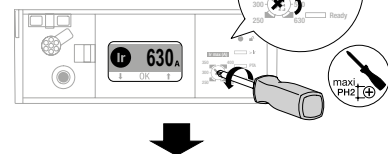
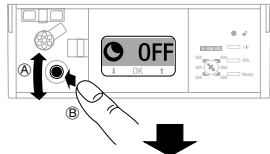
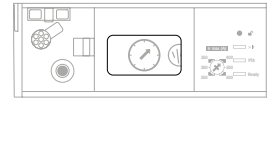
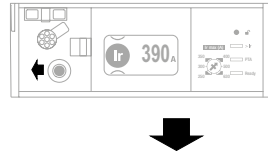
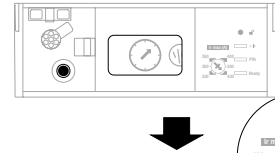
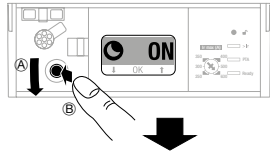
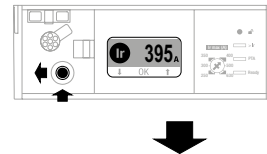
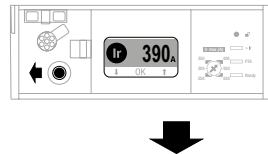
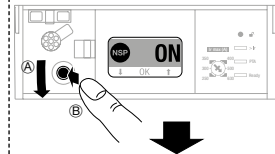
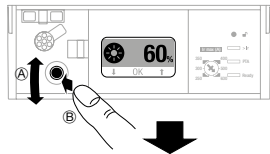
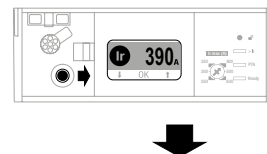
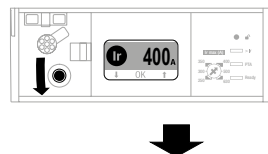
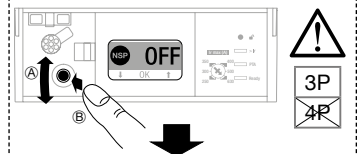
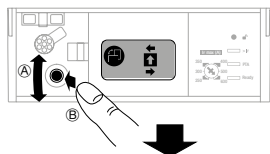

3P
4P

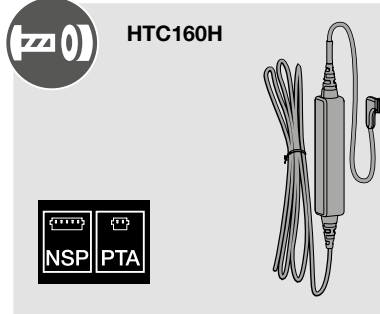
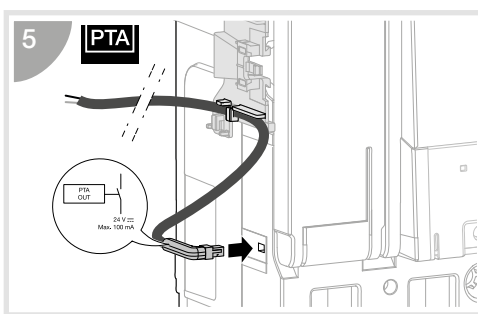
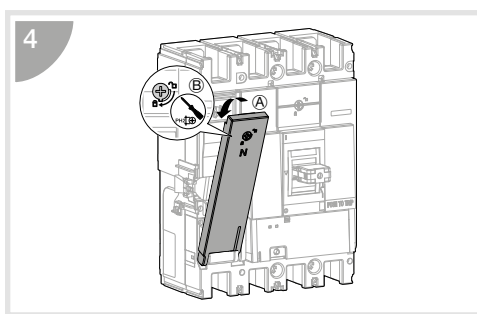
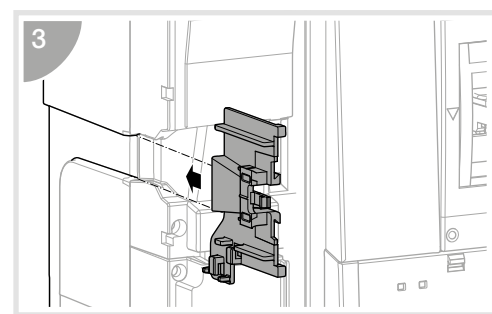
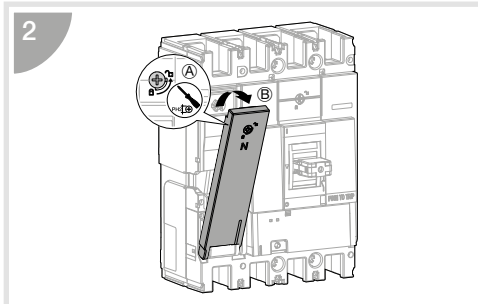
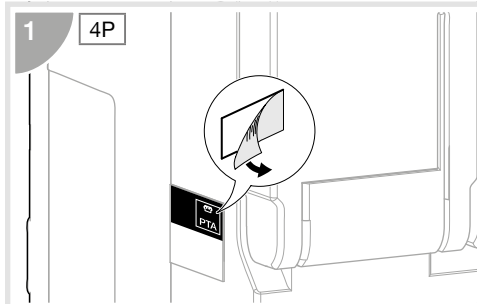

3P
4P

