

Compact67 IO-Link Module

----Profinet System Manual



ELCO (Tianjin) Electronics Co., Ltd.
09/2022
Version 1.7

Preface

1. Scope of this manual:

This manual applies to the ELCO Profinet Compact67 series IO-Link module. The information in this manual enables you to run the Compact67 IO-Link module on Profinet as a distributed I/O device.

2. Basic knowledge requirements

This manual presumes a general knowledge in the field of automation engineering and describes the components based on the data valid at the time of its release.

ELCO reserves the right of including a product information for each new component, and for each component of a later version.

3. Guide:

This manual describes the hardware of the Profinet Compact67 series IO-Link module.

Covered topics are:

- Installation and wiring
- Commissioning and diagnostics
- Components
- Article numbers
- Technical specifications

4. Technical support:

Please contact your local ELCO representative or dial 400-608-4005 if you have any questions about the products described in this manual.

Additional information about ELCO products is available:

<http://www.elco-holding.com/>

5. Disclaimer of liability:

We have reviewed the contents of this publication to ensure consistency with the hardware and software described. Since variance cannot be precluded entirely, we cannot guarantee full consistency. However, the information in this publication is reviewed regularly and any necessary corrections are included in subsequent editions.

Contents

Preface	2
1. Product overview	4
1.1 Introduction	4
1.2 Applications	4
1.3 Features	4
1.4 Type	5
2. Technical characteristics	7
2.1 IO-Link master	7
2.2 IO-Link sensor hub	9
2.3 IO-Link cable	10
2.4 Hardware	11
2.5 LED indicator	17
2.6 General system layout	19
3. Installation wiring	20
3.1 Installation dimensions	20
3.2 Installation position and size	24
3.3 Assigning names in PROFINET IO devices	25
3.4 Wiring Compact67	27
4. Configuration Commissioning	35
4.1 Installation of configuration files	35
4.2 IO-Link master signal address assignment	37
4.3 IO-Link sensor hub signal address assignment	41
4.4 Module Startup Process	45
4.5 Module configuration by Portal	46
5. Alarm diagnosis	55
5.1 LED fault indicator	55
5.2 Process image area of IO-Link Master	57

1. Product overview

1.1 Introduction

The Compact67 module supporting IO-Link function is a new type of distributed I / O system. The simple and easy to install Fieldbus system Compact67 is especially suitable for applications in rough environments.

1.2 Applications

IO-Link is an IO communication technology from the controller to the lowest level of automation. Through the IO-Link master, information such as sensors and actuators is transmitted to the controller via the fieldbus network so as to improve work efficiency and reduce production costs.

ELCO new Compact67 product supporting IO-Link communication, as an IO-Link master, does not require a dedicated communication cable, and can achieve efficient communication with IO-Link device through traditional non-shielded industrial cables. Each IO-Link master can support a maximum of 8 IO-Link interfaces. Optional interface of Class-A or Class-B. It meets the requirements of IO-Link v1.1 and supports three transmission rate - COM1 (4.8kbps), COM2 (38.4kbps), COM3 (230.4kbps). It can easily connect IO-Link sensors of various brands and other IO-Link devices, as well as sensors and actuators of ordinary switching signals.

The IO-Link hub launched at the same time, as an IO-Link device, complies with the IO-Link v1.1 and supports COM2 (38.4kbps). It can be connected with the IO-Link master of ELCO or other brands, which is used to collect digital input signals on-site and control digital output signals. Each hub can connect up to 16 digital signals. With ELCO 8-port IO-Link master module, it can transmit up to 128 digital signals.

1.3 Features

- Up to IP67 protection class
- Designed with IO-Link v1.1 specification
- The IO-Link master supports three communication rates of COM1, 2 and 3
- Interface type Class-A or Class-B is optional
- Connects various IO-Link standard devices and standard switch signals
- LED status display, channel protection and diagnosis

1.4 Type

No.	Type	Description
1	FCPN-8LKM-4A4B	Profinet IO-Link master module 8 IO-Link interfaces (4*Class-A + 4*Class-B) 2 male+female, 7/8" power supply 2 female, M12 D-Code fieldbus interface
2	FCPN-8LKM-8A	Profinet IO-Link master module 8 IO-Link interfaces (8*Class-A) 2 male+female, 7/8" power supply 2 female, M12 D-Code fieldbus interface
3	FCPN-4LKM-4A4S	Profinet IO-Link master module 4 IO-Link interfaces (4*Class-A) 2 male+female, 7/8" power supply 2 female, M12 D-Code fieldbus interface
4	LKHA-1600P-M12	IO-Link sensor hub Class-A (LKHA) interface 16 PNP input signal or dry contact 8 female, M12 A-Code signal interface
5	LKHA-0808P-M12	IO-Link sensor hub Class-A (LKHA) interface 8 PNP input signal or dry contact 8 active output, 0.5A each channel 8 female, M12 A-Code signal interface
6	LKHA-16UP-M12	IO-Link sensor hub Class-A (LKHA) interface 16 PNP input or active output 8 female, M12 A-Code signal interface
7	LKHA-0800P-M8	IO-Link sensor hub Class-A (LKHA) interface 8 PNP input signal or dry contact 8 female, M8-3pin signal interface

8	LKHA-08UP-M8	IO-Link sensor hub Class-A (LKHA) interface 8 PNP input or active output 8 female, M8-3pin signal interface
9	LKHA-0800P-M12	IO-Link sensor hub Class-A (LKHA) interface 8 PNP input signal or dry contact 4 female, M12 A-Code signal interface
10	LKHA-08UP-M12	IO-Link sensor hub Class-A (LKHA) interface 8 PNP input or active output 4 female, M12 A-Code signal interface
11	LKHA-1600N-M12	IO-Link sensor hub Class-A (LKHA) interface 16 NPN input signal or dry contact 8 female, M12 A-Code signal interface
12	LKHA-16UN-M12	IO-Link sensor hub Class-A (LKHA) interface 16 NPN input or active output 8 female, M12 A-Code signal interface

2. Technical characteristics

2.1 IO-Link master

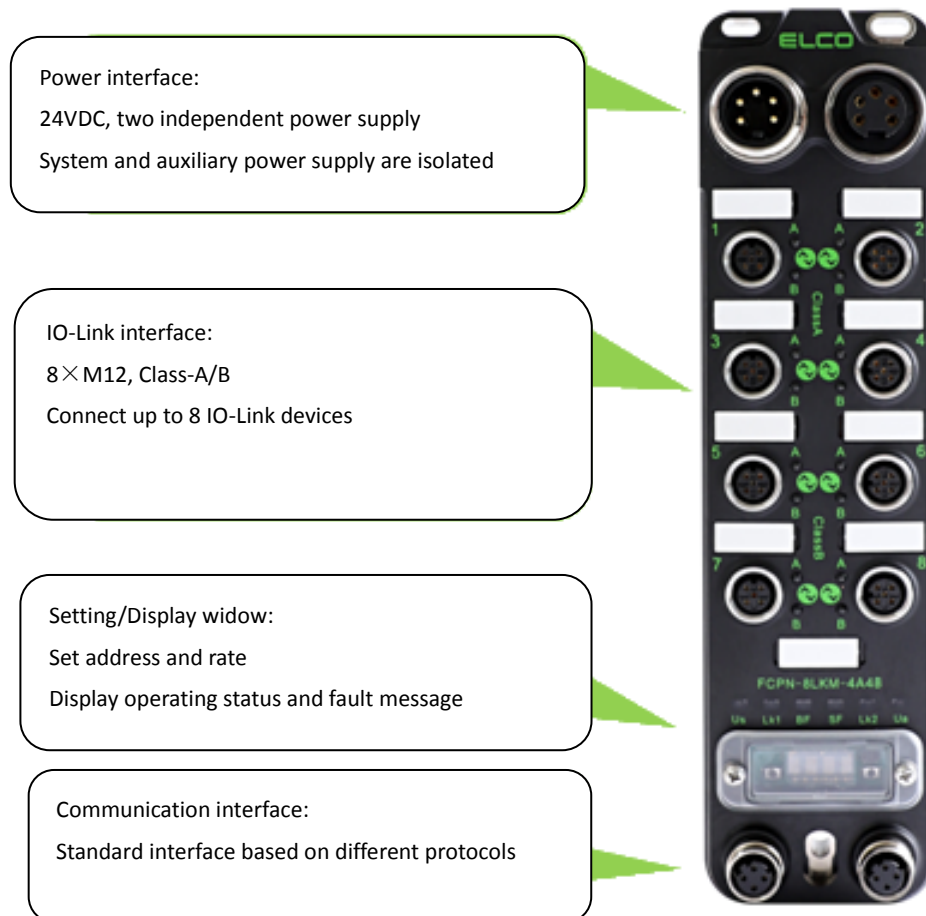

Each Compact67 series IO-Link master module occupies a Profinet slave address.

Depending on the type, up to 8 IO-Link devices can be connected. Depending on the specific requirements, select the module of Class-A or Class-B interface.

As a Profinet slave, the Compact67 module can specify the device name and the corresponding IP address through the configuration software, or it can automatically assign an IP address by the PLC according to the network topology, thereby realizing the communication of the Profinet network based on the industrial Ethernet structure. The customer can set the IO-Link interface to the communication mode that meets the requirements of IO-Link v1.1 or the SIO mode used as standard digital input and output in the programming software as required. Due to there are two IO-Link specifications, Class-A and Class-B, users need to select different types of IO-Link master modules according to their needs and IO-Link device characteristics. The IO-Link interface supports a total of three transmission rate: COM1 (4.8kbps),

COM2 (38.4kbps) and COM3 (230.4kbps). The rate will be adaptive according to the characteristics of the IO-Link device.

2.2 IO-Link sensor hub



The Compact67 series IO-Link sensor hub can be used as an IO-Link device to connect with the IO-Link master of ELCO or other brands. It conforms to the IO-Link v1.1 standard and supports COM2 (38.4kbps) transmission rate. Each IO-Link interface of the IO-Link master module can be extended with an IO-Link hub to collect input and output signals. That is, an 8-port IO-Link master plus 8 IO-Link hubs which can connect up to 128 digital signals.

IO-Link sensor hub has different types to choose from, there are products that support Class-A or Class-B standards, and also include two different signal interface - M12 and M8.

M12 A-Code, 2 digital or 1 analog are available.

M8, 3-pin, 1 digital is available.

2.3 IO-Link cable

According to the IO-Link protocol, point-to-point transmission is used between the IO-Link master and device. With the ordinary unshielded industrial cables (such as sensor cables), an extended distance of 20 meters can be reached.

According to the IO-Link protocol standard, ordinary 3-core cables can meet transmission requirements, and the 4-core or 5-core cables are used for specific functions. The Compact67 series IO-Link module needs to determine what kind of cable connection to use according to the interface type and IO type of the IO-Link hub.

- 1) Class-A IO-Link interface, because only three pins are defined, the fourth pin can be used as auxiliary power supply, so input IO-Link hub can use three-core cable, output IO-Link hub requires a four-core cable.
- 2) Class-B IO-Link interface, because all five pins are defined, when using this IO-Link hub to connect to the IO-Link master, a five-core cable should be used.

2.4 Hardware

2.4.1 IO-Link master

Ordering data			
Product type	FCPN-8LKM-4A4B	FCPN-8LKM-8A	FCPN-4LKM-4A4S
Description	8 IO-Link ports	8 IO-Link ports	4 IO-Link ports
Communication			
Protocol	Profinet		
Operating modes	Auto-negotiation , Auto-MDI/MDI-X		
Transfer rate	10/100 Mbps		
Addressing	Profinet standard , DCP		
Topology	Support		
Media Redundancy Protocol	Support		
Power supply			
Supply voltage	24 VDC (18...30 VDC)		
Current consumption	Max. 200mA		
System & Input supply	Us , Max. 8A		
Output supply	Ua , Max. 8A		
Electrical isolation	Us and Ua completely isolated		
Connections			
Power supply	2 x 7/8" 5pin , Male+Female		
Fieldbus	2 x M12 D-code 4pin , Female		
Signals	8 x M12 A-code 5pin , Female		
Interface			
IO-Link ports	8	8	4
IO-Link type	4*Class-A + 4*Class-B	8*Class-A	4*Class-A
IO-Link version	IO-Link V1.1		
IO-Link communication rates	COM1 (4.8kbps) 、 COM2 (38.4kbps) 、 COM3 (230.4kbps)		
Input channels	Max. 12	Max. 16	Max. 16
Input supply current	IO-Link : 1.6A per channel , Signal : 200mA per channel		
Auxiliary supply current	2A per channel		
Input type	PNP sensors , mechanical switches , dry contacts , etc..		

Input delay	1.6 ms		
Output channels	Max. 12	Max. 16	Max. 16
Output current	Max. 2A per channel (Pin2) Max. 100mA per channel (Pin4)		
Output type	Lamps , solenoid valve , etc..		
Output frequency	Resistive load 100Hz , Inductive load 5Hz		
Diagnostics			
Communication indication	LED indication , Communication message		
Voltage detection	Support , Low voltage alarm		
Short-circuit & Overload	Support , LED indication		
General data			
Protection	IP67		
Temperature	Operating -25...+70 °C , Storage -40...+85 °C		
Dimensions (W*H*D)	60x230x39 mm		

2.4.2 M12-16 signals IO-Link sensor hub

PNP signal type

Ordering data			
Product type	LKHA-1600P-M12	LKHA-0808P-M12	LKHA-16UP-M12
Description	16DI , Class-A , 8*M12	8DI+8DO , Class-A , 8*M12	16DI/DO , Class-A , 8*M12
Connections			
IO-Link	Class-A : 1 x M12 A-code 4pin , Male		
Power supply	Included in IO-Link interface		
Signals	8 x M12 A-code 5pin , Female		
Interface			
Input channels	16	8	-
Input supply current	Max. 200mA per channel		
Input type	PNP sensors , mechanical switches , dry contacts , etc..		
Input delay	1.6 ms		
Output channels	-	8	16
Output current	Max. 500mA per channel , 2A in total		
Output type	Lamps , solenoid valve , etc..		
Output frequency	Resistive load 100Hz , Inductive load 5Hz		
Diagnostics			
Communication indication	LED indication , Communication message		
Voltage detection	Support , Low voltage alarm		
Short-circuit & Overload	Support , LED indication		
General data			
Protection	IP67		
Temperature	Operating -25...+70 °C , Storage -40...+85 °C		
Dimensions (W*H*D)	55x145x29 mm		

NPN signal type

Ordering data			
Product type	LKHA-1600N-M12	LKHA-0808N-M12	LKHA-16UN-M12
Description	16DI , Class-A , 8*M12	8DI+8DO , Class-A , 8*M12	16DI/DO , Class-A , 8*M12
Connections			
IO-Link	Class-A : 1 x M12 A-code 4pin , Male		
Power supply	Included in IO-Link interface		
Signals	8 x M12 A-code 5pin , Female		
Interface			
Input channels	16	8	-
Input supply current	Max. 200mA per channel		
Input type	NPN sensors , mechanical switches , dry contacts , etc..		
Input delay	1.6 ms		
Output channels	-	8	16
Output current	Max. 500mA per channel , 2A in total		
Output type	Lamps , solenoid valve , etc..		
Output frequency	Resistive load 100Hz , Inductive load 5Hz		
Diagnostics			
Communication indication	LED indication , Communication message		
Voltage detection	Support , Low voltage alarm		
Short-circuit & Overload	Support , LED indication		
General data			
Protection	IP67		
Temperature	Operating -25...+70 °C , Storage -40...+85 °C		
Dimensions (W*H*D)	55x145x29 mm		

2.4.3 M8-8 signals IO-Link sensor hub

Ordering data		
Product type	LKHA-0800P-M8	LKHA-08UP-M8
Description	8DI , Class-A , 8*M8	8DI/DO , Class-A , 8*M8
Connections		
IO-Link	Class-A : 1 x M12 A-code 4pin , Male	
Power supply	Included in IO-Link interface	
Signals	8 x M8 3pin , Female	
Interface		
Input channels	8	-
Input supply current	Max. 200mA per channel	
Input type	PNP sensors , mechanical switches , dry contacts , etc..	
Input delay	1.6 ms	
Output channels	-	8
Output current	Max. 500mA per channel , 2A in total	
Output type	Lamps , solenoid valve , etc..	
Output frequency	Resistive load 100Hz , Inductive load 5Hz	
Diagnostics		
Communication indication	LED indication , Communication message	
Voltage detection	Support , Low voltage alarm	
Short-circuit & Overload	Support , LED indication	
General data		
Protection	IP67	
Temperature	Operating -25...+70 °C , Storage -40...+85 °C	
Dimensions (W*H*D)	55x145x29 mm	

2.4.4 M12-8 signals IO-Link sensor hub

Ordering data		
Product type	LKHA-0800P-M12	LKHA-08UP-M12
Description	8DI , Class-A , 4*M12	8DI/DO , Class-A , 4*M12
Connections		
IO-Link	Class-A : 1 x M12 A-code 4pin , Male	
Power supply	Included in IO-Link interface	
Signals	4 x M12 A-code 5pin , Female	
Interface		
Input channels	8	-
Input supply current	Max. 200mA per channel	
Input type	PNP sensors , mechanical switches , dry contacts , etc..	
Input delay	1.6 ms	
Output channels	-	8
Output current	Max. 500mA per channel , 2A in total	
Output type	Lamps , solenoid valve , etc..	
Output frequency	Resistive load 100Hz , Inductive load 5Hz	
Diagnostics		
Communication indication	LED indication , Communication message	
Voltage detection	Support , Low voltage alarm	
Short-circuit & Overload	Support , LED indication	
General data		
Protection	IP67	
Temperature	Operating -25...+70 °C , Storage -40...+85 °C	
Dimensions (W*H*D)	55x93x29 mm	

2.5 LED indicator

The module's indicator can clearly indicate its operating status. For specific fault indications and solutions, please refer to Section 5.1 “LED Fault Indicator”.

IO-Link master indicator

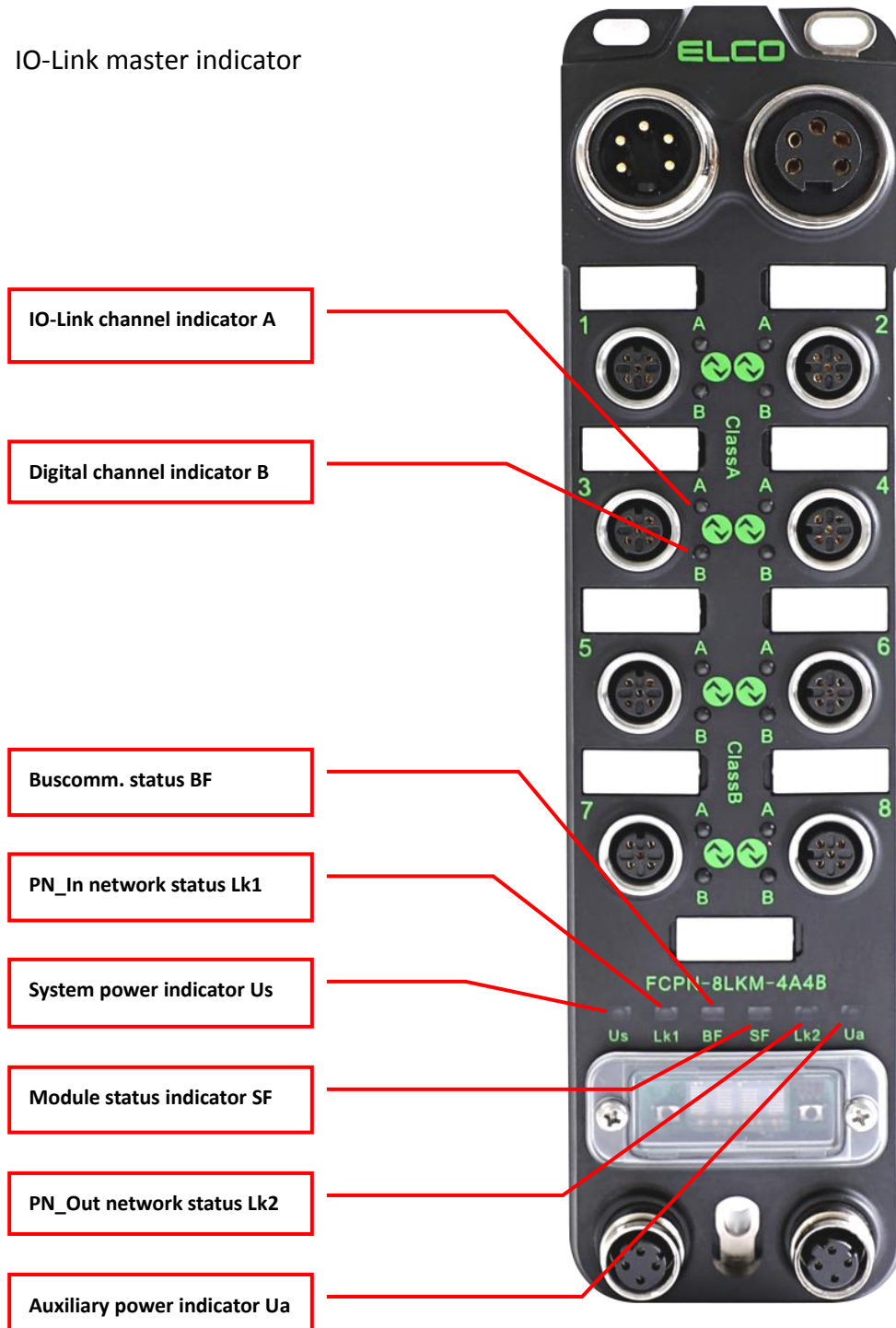

IO-Link sensor hub indicator

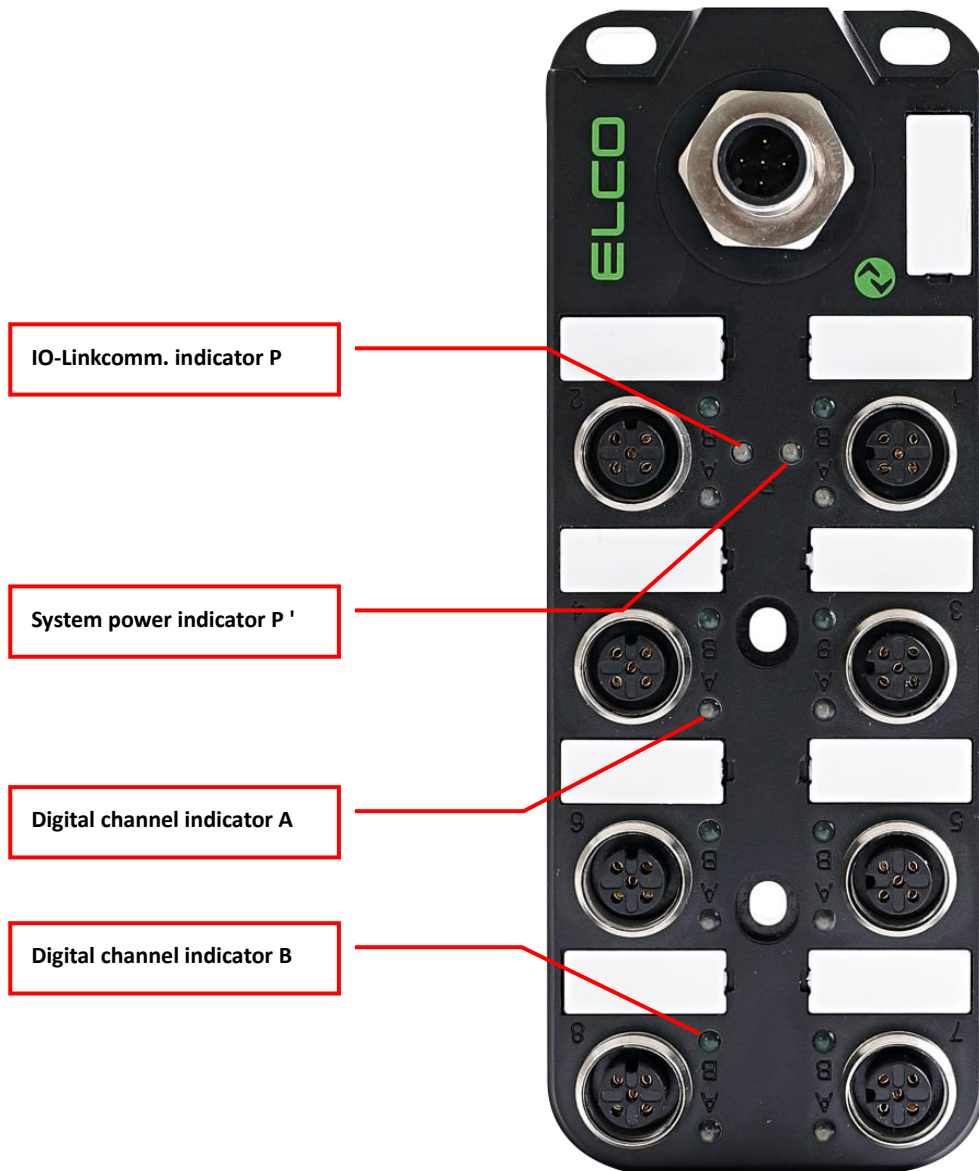

2.6 General system layout



3.1.2 IO-Link sensor hub dimensions

1) 16 signals, M12 interface

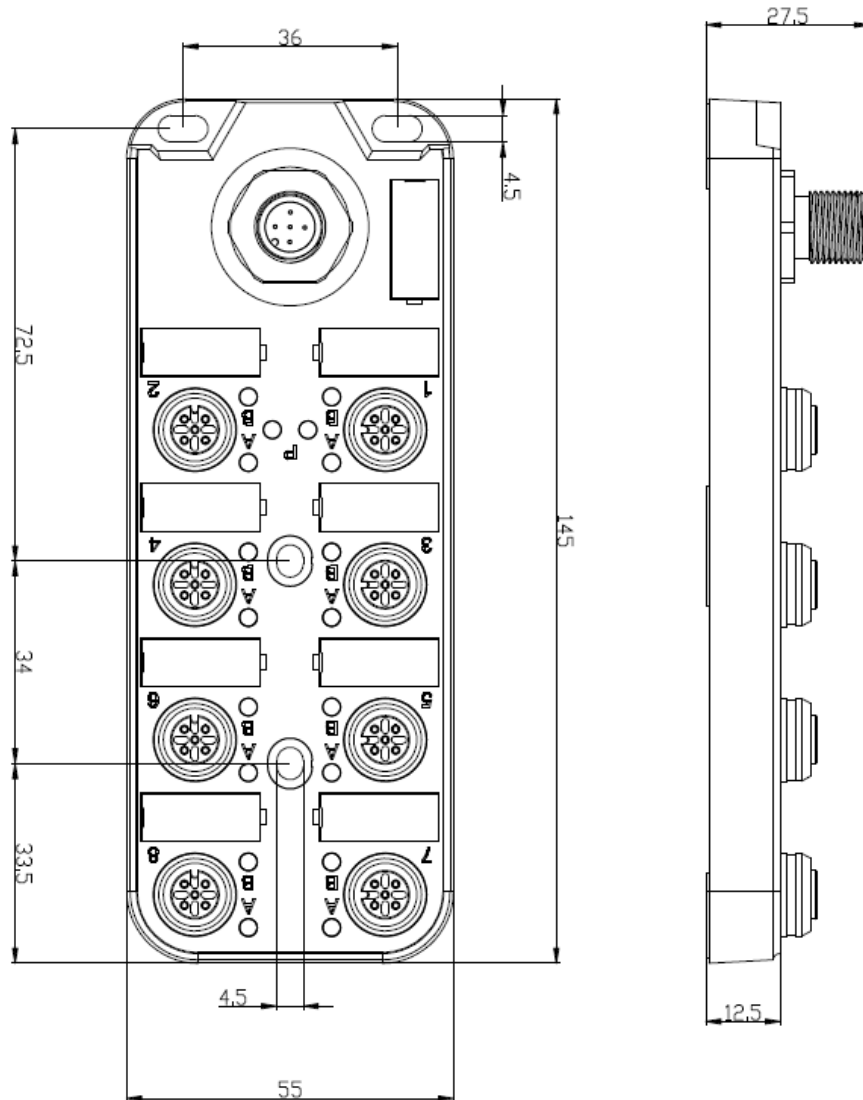

2) 8 signals, M8 interface

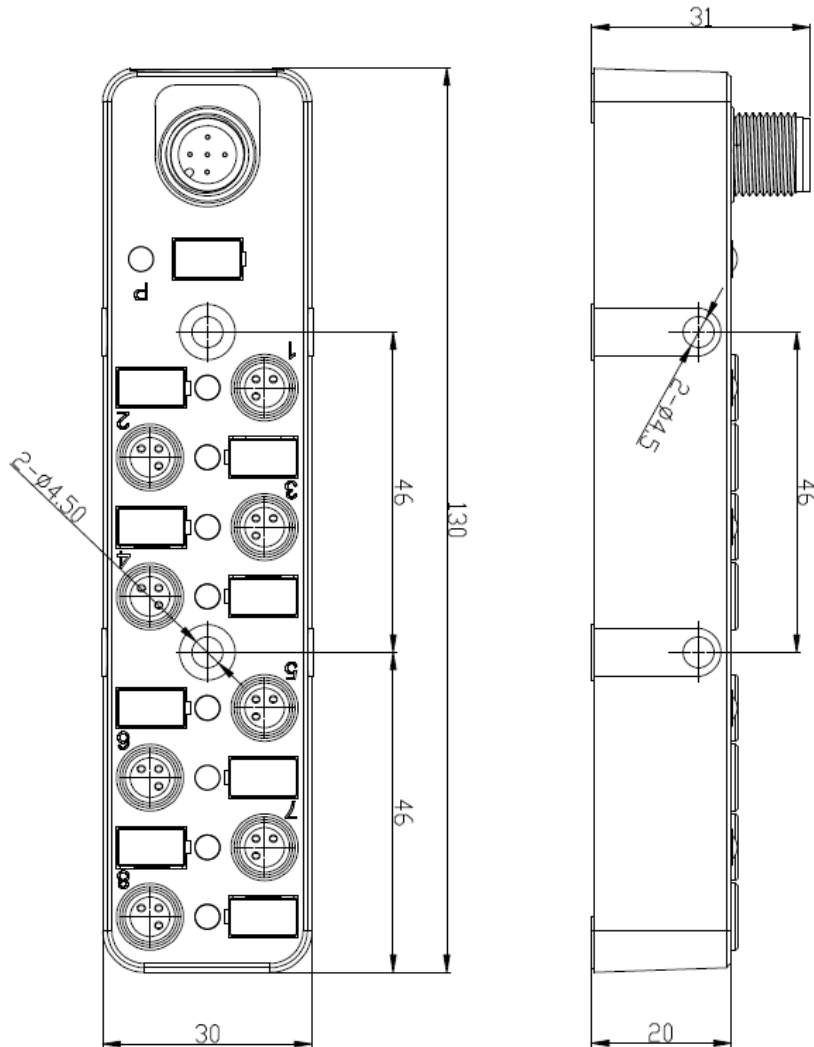

3) 8 signals, M12 interface

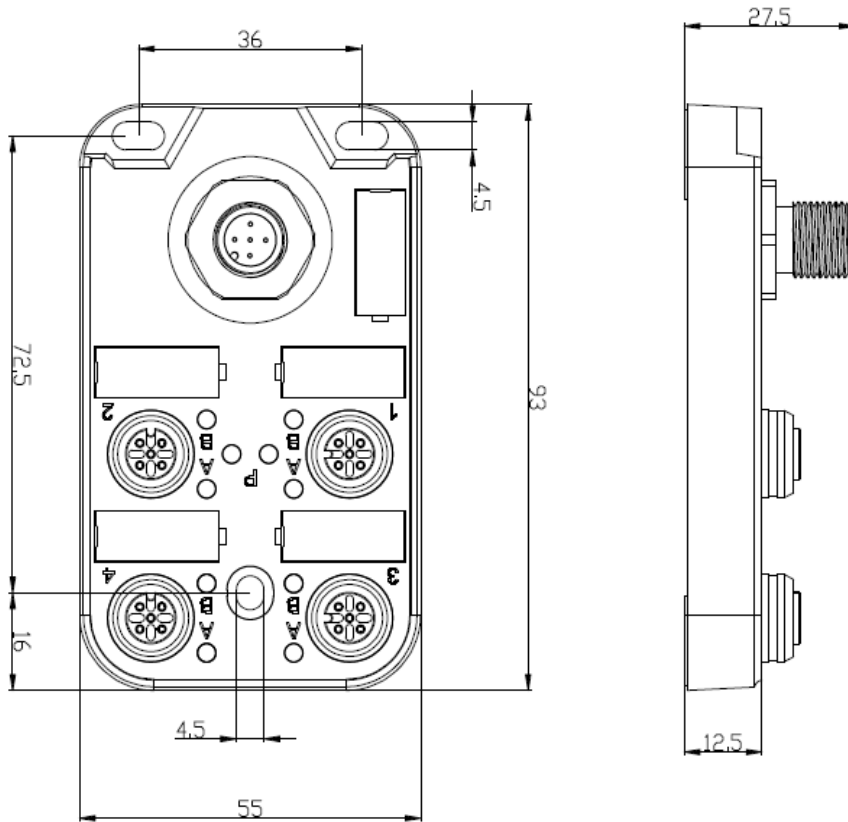

3.2 Installation position and size

Thanks to IP67 high protection level and excellent resistance to vibration and interference, Compact67 products can be installed in almost any location.

The Compact67 series uses a compact design to minimize installation space. Its IO-Link master module and IO-Link sensor hub use standard dimensions. The following table shows the module installation dimensions:

	Gateway	16 signals M12	8 signals M8	8 signals M12
Installation width	60mm	55mm	30mm	55mm
Installation height	230mm	145mm	130mm	93mm
Installation depth	35mm	29mm	31mm	29mm

3.3 Assigning names in PROFINET IO devices

Each Compact67 distributed I / O device of Profinet protocol is assigned a unique device ID (ie, MAC address) before leaving the factory. Each Compact67 device needs to be addressed based on the device name during configuration and in the user program. Therefore it needs to assign a device name to each Compact67 series IO-Link master module before configuration and commissioning.

The Siemens Portal software can easily assign information such as the device name and IP address to Profinet IO devices. Please follow the steps below:

- 1) Provide power for the Compact67 module, and place it in the same network as the configuration computer through a switch or network cable.
- 2) In the "Online access" of the "Project tree" on the left side of the Portal software, select the corresponding network card and update the accessible devices.
- 3) In the tree structure, you can see the Profinet device connected to the computer, and select the Compact67 module to assign the device name by MAC address.

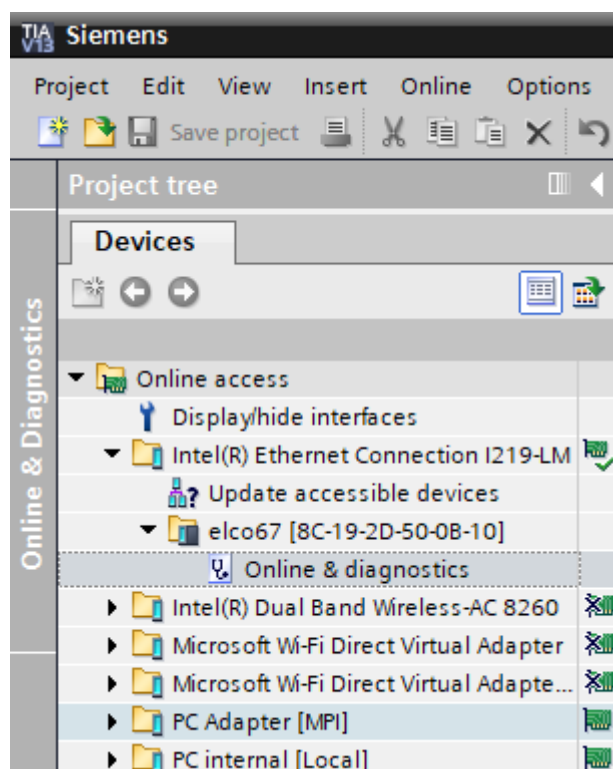

4) In the "Online access" window on the right, with the "Assign name" option, you can assign a set device name to the Compact67 module

- 5) It is also possible to assign a new IP address directly to the Compact67

module via the "Assign IP address" option. (Allocation of IP addresses can also be done during device configuration)

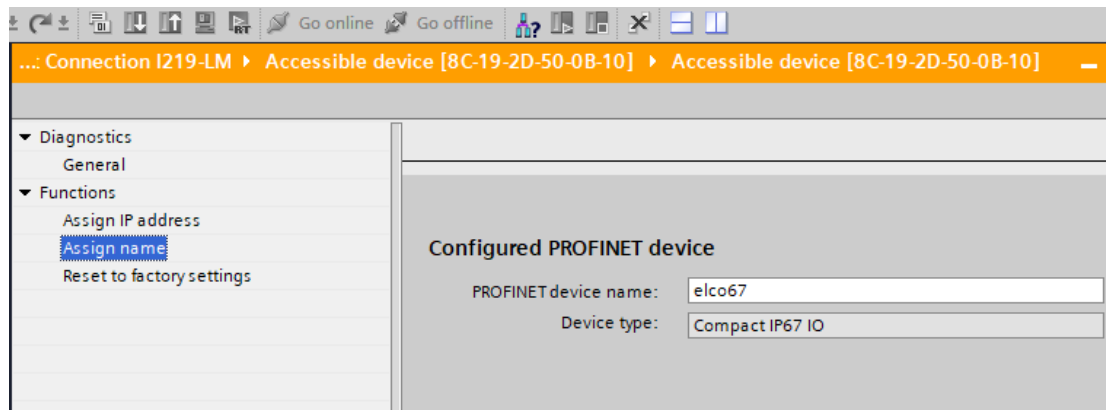

6) You can now use the newly assigned device name as the identification of the Compact67 module in your program for configuration debugging.

Note: The MAC address of the Compact67 series IO-Link master module is marked on the side of the module in the form of laser engraving or label. The newly assigned device name may need to be re-power on to use correctly.

3.4 Wiring Compact67

Please make sure to cut off power supply when wiring to ensure safety.

3.4.1 Connecting Compact67 to protective earth (PE)

- Always connect the Spider67 to protective earth.
- The module also requires this connection to protective earth in order to discharge any interference currents to ground, and for EMC compatibility.
- Always make sure you have a low-impedance connection to protective earth.

3.4.2 Compact67 power supply

Compact67 series IO-Link module adopts 24VDC power supply, and power IO-Link sensor hub by extensible cable, voltage range 18~30VDC, standard 7/8" connector. System and sensor power supply U_s (+24V, 0V), auxiliary power supply U_a (P24, N24). Power supply U_s and U_a of different types of modules have different isolation forms:

- 1) FCPN-8LKM-4A4B, the two power supply are completely isolated, that is, electrical isolation between +24V and P24, and electrical isolation between 0V and N24.
- 2) FCPN-8LKM-8A and FCPN-4LKM-4A4S, the two power supply are partially isolated, that is, electrical isolation between +24V and P24, and internally connected between 0V and N24.

- 1) Power in(Male)

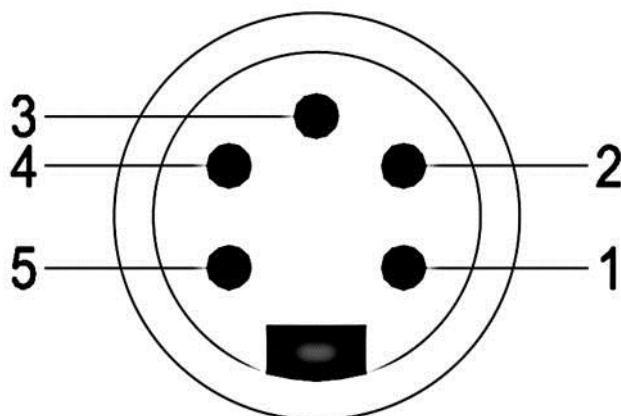

2) Power out (Female)

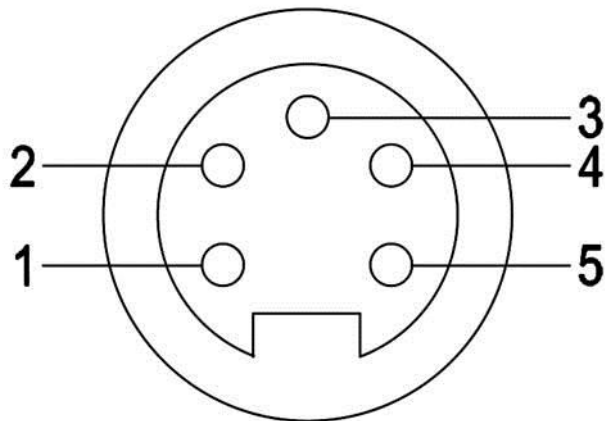

3) Power definition

Terminal	Function	Power supply
1	Auxiliary power supply Ua-	0V
2	System and sensor power supply Us-	0V
3	PE	
4	System and sensor power supply Us+	24V
5	Auxiliary power supply Ua+	24V

3.4.3 Compact67 BUS connection

Compact67 module, supporting Profinet protocol, transmits signals by a shielded cable, D-Code M12 connector.

1) BUS-In (Female)

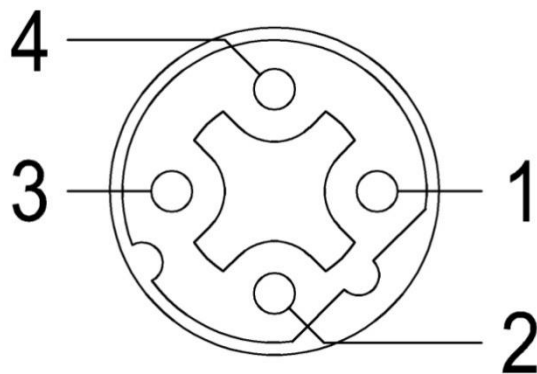

2) BUS-Out (Female)

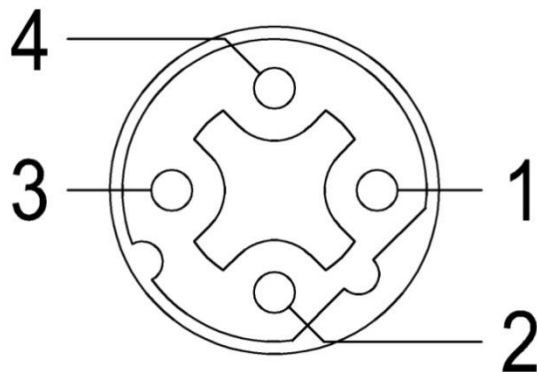

3) Bus definition

Terminal	Function	Cable color
1	Transmit Data (TD+)	Yellow
2	Receive Data (RD+)	White
3	Transmit Data (TD-)	Orange
4	Receive Data (RD-)	Blue

3.4.4 IO-Link master port cable connection

All Compact67 series IO-Link masters are connected through a standard 5-pin M12 connector. Each M12 port can be connected to a maximum of 1 IO-Link signal or 2 switching signals (input or output).

- 1) IO-Link port connector (Female)

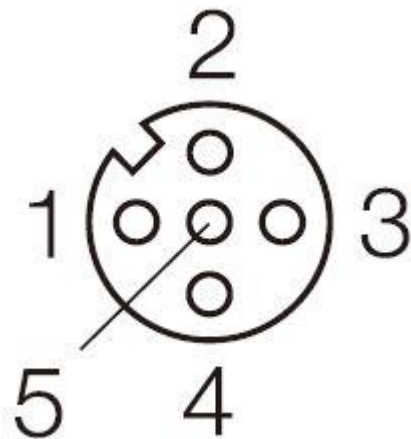

M12 connector

- 2) IO-Link port pin definition

Terminal	Class-A	Class-B
1	Power supply 24V+	Power supply 24V+
2	Signal input/output B	Auxiliary power supply P24
3	Power supply GND	Power supply GND
4	IO-Link/input/output A	IO-Link/input/output A
5	-	Auxiliary power N24

3) The power supply (Pin1 and Pin3) and signal input (Pin4 and Pin2) and signal output (Pin4) power supply are from the system power supply U_s , the auxiliary power supply and signal output (Pin2) power supply are from the auxiliary power supply U_a .

Note: For FCPN-8LKM-4A4B, Pin2 and Pin4 of Class-A interface and Pin4 of Class-B interface are also supplied by system power supply U_s .

Note: When the master station of Class-A interface is used to connect LKHA series slaves, the output of Pin2 (i.e. signal B) can be controlled by program to meet the output power supply of LKHA slaves.

3.4.5 IO-Link hub digital signal cable connection

All Compact67 series IO-Link sensor hubs are connected through standard 5-pin M12 or 3-pin M8 connectors. Each M12 port can connect up to 2 signals (input or output), and each M8 port can connect 1 signal (input or output).

1) Signal I/O connector(Female)

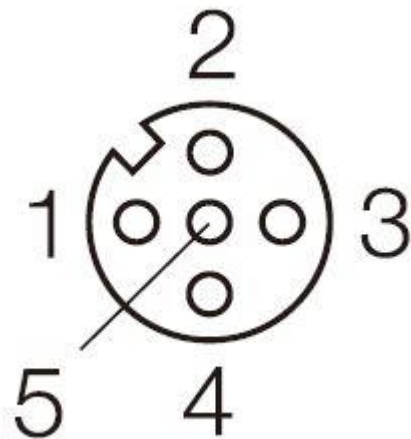

M12 connector

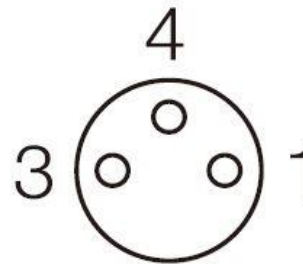

M8 connector

2) Digital signal port definition

Terminal	M12 connector		M8 connector
1	Power supply 24V+		Power supply 24V +
2	Signal input/output B	2 nd signal	-
3	Power supply GND		Power supply GND
4	Signal input/output A	1 st signal	Signal input / output
5	Shielded grounding PE		-

3) Wiring example

a) Double PNP input signal – 1 connector connects 2 DI, LKHA-1600P-M12, LKHA-0808P-M12, LKHA-16UP-M12, LKHA-0800P-M12, LKHA-08UP-M12 support this connection.

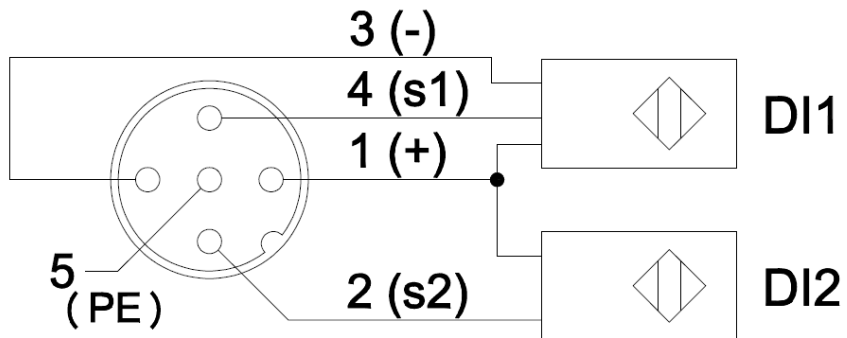

b) Double PNP output signal – 1 connector connects 2 DO, LKHA-0808P-M12, LKHA-16UP-M12, LKHA-08UP-M12 support this connection.

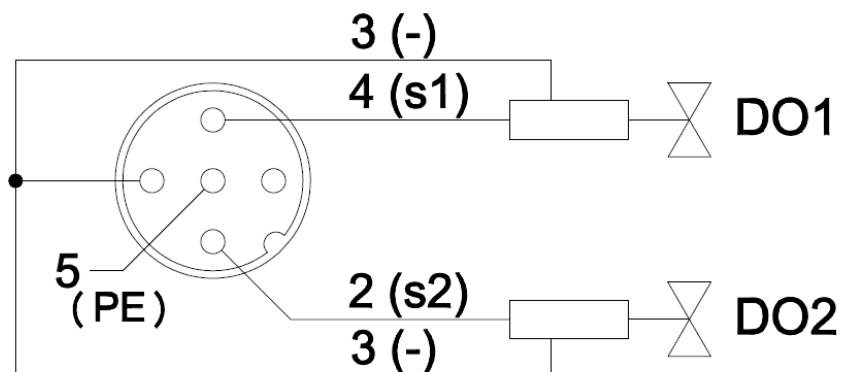

c) PNP Input and output signal – 1 connector connects 1 DI and 1 DO.
 LKHA-16UP-M12, LKHA-08UP-M12 support this connection.

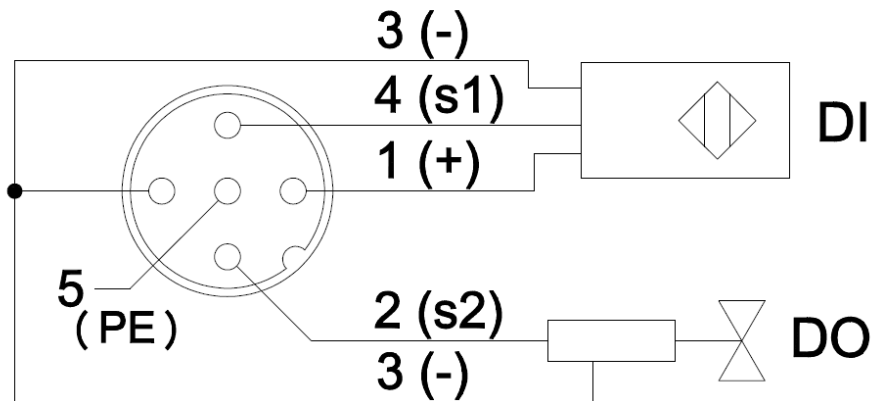

d) Double NPN input signal – 1 connector connects 2 DI, LKHA-1600N-M12,
 LKHA-16UN-M12 support this connection.

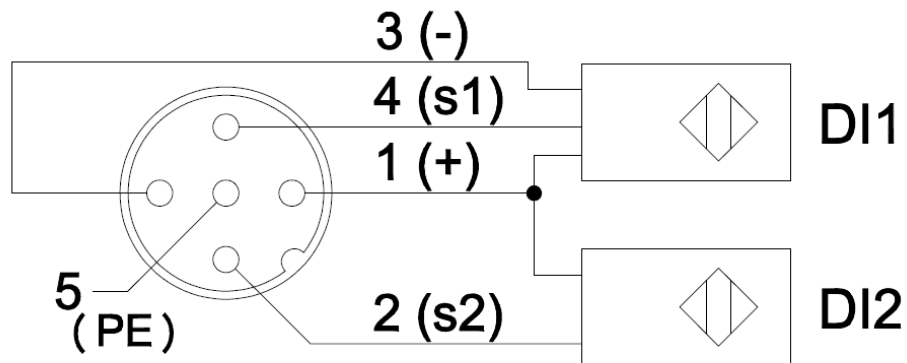

e) NPN Input and output signal – 1 connector connects 1 DI and 1 DO.
LKHA-16UN-M12 support this connection.

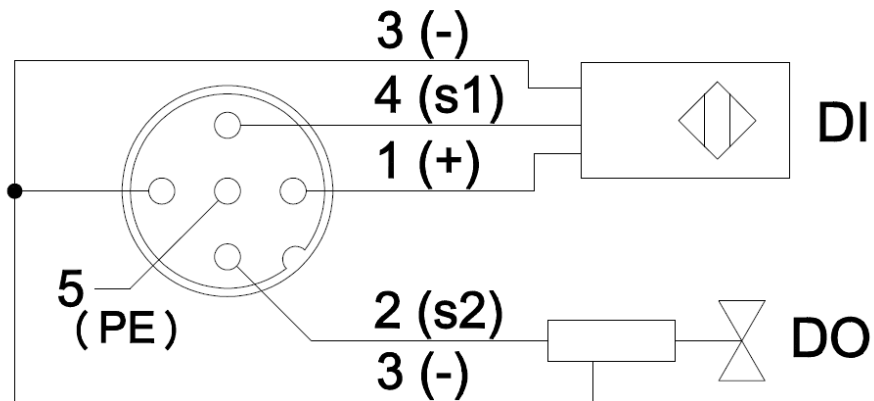

f) Single PNP input signal – 1 connector connects 1 DI, LKHA-0800P-M8,
LKHA-08UP-M8 support this connection.

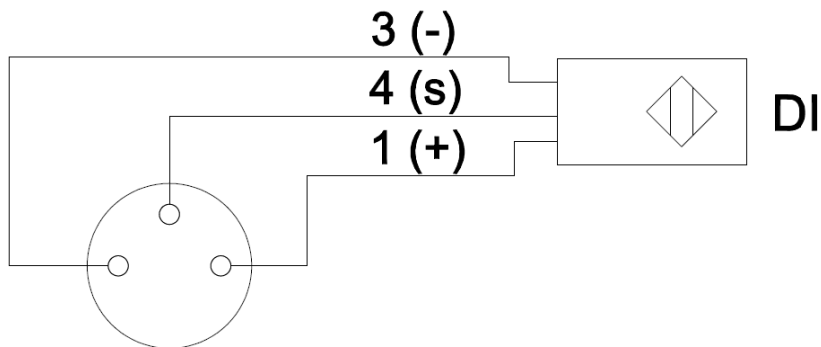

g) Single PNP output signal – 1 connector connects 1 DO, LKHA-08UP-M8
support this connection.

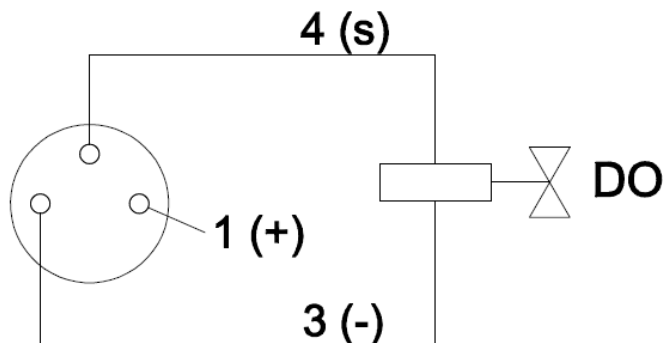

4. Configuration Commissioning

4.1 Installation of configuration files

Configuration of the Compact67 series I/O module via GSD file (XML format) and the standard Profinet IO GSD file for the Compact67 will be integrated into the user's system. You can visit the ELCO website to get the latest GSD file or call the hotline to contact technical support.

How to integrate the GSD file into the system depends on the user's configuration software. The Siemens Portal programming software used by Profinet systems usually integrates GSD files according to the following steps:

- 1) Run Portal, and then select "Options>Manage general station description files (GSD)".

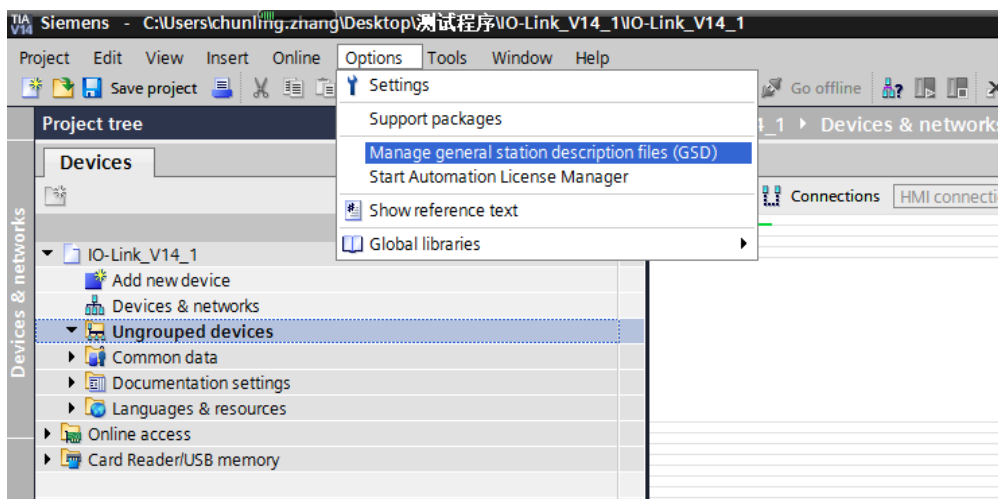

- 2) Browse to the file's directory in the next dialog, choose the GSD file and then click "Install".

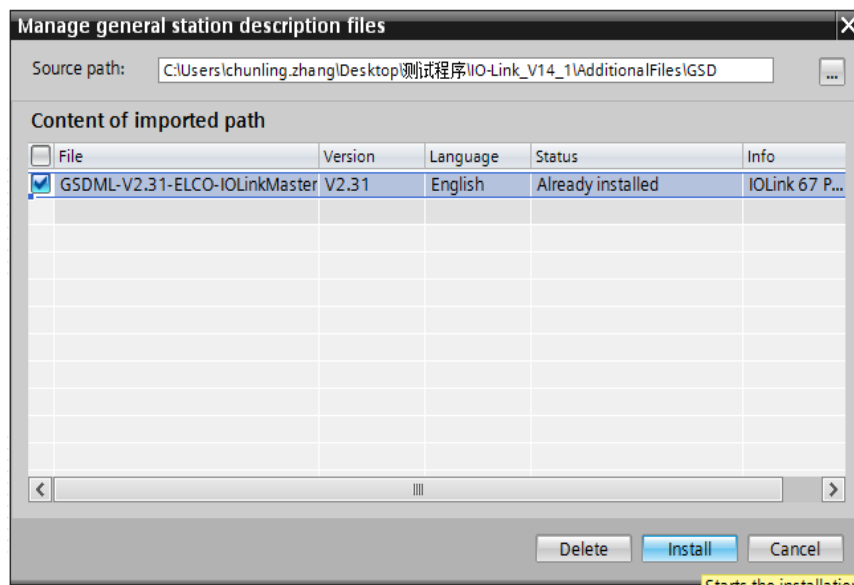

3) The new added IO-Link master module is shown in the directory of hardware "Other field devices>PROFINETIO > I/O > ELCO > IOLINK67 Gateway Module".

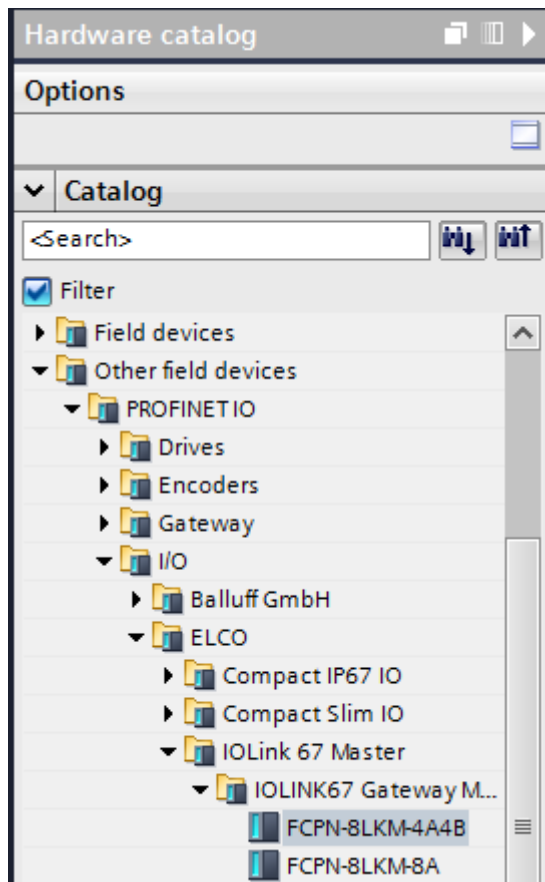

4) The user can configure the Compact67 IO-Link module with Portal according to the actual situation.

4.2 IO-Link master signal address assignment

Each Compact67 series IO-Link master has 8 M12 ports (Port1 ~ Port8), which are used to expand IO-Link communication or connect digital input and output. Each connector has 5 pins (Pin1 ~ Pin5) . At present, the IO-Link master has the following three models, the type and number of channels are as follows:

No.	Model	IO-Link channel	Input signal	Output signal
1	FCPN-8LKM-4A4B	4*Class-A + 4*Class-B	Max.12	Max.12
2	FCPN-8LKM-8A	8*Class-A	Max.16	Max.16
3	FCPN-4LKM-4A4S	4*Class-A + 4*SIO	Max.16	Max.16

The IO-Link master interface is configured as a normal digital input and output by default in the program, occupying 4Byte input and 2Byte output. Customers can set the corresponding ports to IO-Link communication mode according to their needs. For specific methods, please refer to the descriptions in the following sections.

Device overview							
	...	Module	Rack	Slot	I address	Q address	Type
		▼ ELCO-IOLINK67MODULE	0	0			FCPN-8LKM-4A4B
		▶ Interface	0	0 X1			ELCO-IOLINK67MO...
		Digital I/O_1	0	1			Digital I/O
		Digital I/O_2	0	2			Digital I/O
		Digital I/O_3	0	3			Digital I/O
		Digital I/O_4	0	4			Digital I/O
		Digital I/O_5	0	5			Digital I/O
		Digital I/O_6	0	6			Digital I/O
		Digital I/O_7	0	7			Digital I/O
		Digital I/O_8	0	8			Digital I/O
		IOLINK Fixed 8 Input/Output...	0	9	0...3	0...1	IOLINK Fixed 8 Inp...
			0	10			
			0	11			

For the ordinary input and output signals of the IO-Link master, the first two bytes of the four input bytes indicate the signal status, the last two bytes indicate the gateway fault status, and the two output bytes all indicate the signal status. In order to maintain uniformity, all signal addresses are arranged in order, and even unused points will occupy corresponding addresses. The following shows the matchup between the signal status of each connector and the Profinet bytes.

1) 4A+4B, 8 ports IO-Link master module FCPN-8LKM-4A4B

Byte	Bit	Connector	e.g.
Input/Output Byte 0	Bit 0	Port1.Pin4	I 0.0 Q 0.0
	Bit 1	Port1.Pin2	I 0.1 Q 0.1
	Bit 2	Port2.Pin4	I 0.2 Q 0.2
	Bit 3	Port2.Pin2	I 0.3 Q 0.3
	Bit 4	Port3.Pin4	I 0.4 Q 0.4
	Bit 5	Port3.Pin2	I 0.5 Q 0.5
	Bit 6	Port4.Pin4	I 0.6 Q 0.6
	Bit 7	Port4.Pin2	I 0.7 Q 0.7
Input/Output Byte 1	Bit 0	Port5.Pin4	I 1.0 Q 1.0
	Bit 1	Port5.Pin2	For auxiliary power supply
	Bit 2	Port6.Pin4	I 1.2 Q 1.2
	Bit 3	Port6.Pin2	For auxiliary power supply
	Bit 4	Port7.Pin4	I 1.4 Q 1.4
	Bit 5	Port7.Pin2	For auxiliary power supply
	Bit 6	Port8.Pin4	I 1.6 Q 1.6
	Bit 7	Port8.Pin2	For auxiliary power supply

2) 8A, 8 ports IO-Link master module FCPN-8LKM-8A

Byte	Bit	Connector	e.g.
Input/Output Byte 0	Bit 0	Port1.Pin4	I 0.0 Q 0.0
	Bit 1	Port1.Pin2	I 0.1 Q 0.1
	Bit 2	Port2.Pin4	I 0.2 Q 0.2
	Bit 3	Port2.Pin2	I 0.3 Q 0.3
	Bit 4	Port3.Pin4	I 0.4 Q 0.4
	Bit 5	Port3.Pin2	I 0.5 Q 0.5
	Bit 6	Port4.Pin4	I 0.6 Q 0.6
	Bit 7	Port4.Pin2	I 0.7 Q 0.7
Input/Output Byte 1	Bit 0	Port5.Pin4	I 1.0 Q 1.0
	Bit 1	Port5.Pin2	I 1.1 Q 1.1
	Bit 2	Port6.Pin4	I 1.2 Q 1.2
	Bit 3	Port6.Pin2	I 1.3 Q 1.3
	Bit 4	Port7.Pin4	I 1.4 Q 1.4
	Bit 5	Port7.Pin2	I 1.5 Q 1.5
	Bit 6	Port8.Pin4	I 1.6 Q 1.6
	Bit 7	Port8.Pin2	I 1.7 Q 1.7

3) 4A+4S, 4 ports IO-Link master module FCPN-4LKM-4A4S

Byte	Bit	Connector	e.g.
Input/Output Byte 0	Bit 0	Port1.Pin4	I 0.0 Q 0.0
	Bit 1	Port1.Pin2	I 0.1 Q 0.1
	Bit 2	Port2.Pin4	I 0.2 Q 0.2
	Bit 3	Port2.Pin2	I 0.3 Q 0.3
	Bit 4	Port3.Pin4	I 0.4 Q 0.4
	Bit 5	Port3.Pin2	I 0.5 Q 0.5
	Bit 6	Port4.Pin4	I 0.6 Q 0.6
	Bit 7	Port4.Pin2	I 0.7 Q 0.7
Input/Output Byte 1	Bit 0	Port5.Pin4	I 1.0 Q 1.0
	Bit 1	Port5.Pin2	I 1.1 Q 1.1
	Bit 2	Port6.Pin4	I 1.2 Q 1.2
	Bit 3	Port6.Pin2	I 1.3 Q 1.3
	Bit 4	Port7.Pin4	I 1.4 Q 1.4
	Bit 5	Port7.Pin2	I 1.5 Q 1.5
	Bit 6	Port8.Pin4	I 1.6 Q 1.6
	Bit 7	Port8.Pin2	I 1.7 Q 1.7

4.3 IO-Link sensor hub signal address assignment

Compact67 series IO-Link hubs have three dimensions: 16 signals_8 M12 ports (Port1 ~ Port8), 8 signals_8 M8 ports (Port1 ~ Port8), 8 signals_4 M12 ports (Port1 ~ Port4). Each M12 port has 5 pins (Pin1 ~ Pin5) and each M8 port has 3 pins (Pin1, Pin3, Pin4). The following table shows the matchup between the signal status of each connector and the Profinet bus transmission byte.

1) 8 DI modules LKHA-0800P-M12, LKHA-0800P-M8

This module takes 1 byte of input.

Byte	Bit	M12 connector LKHA-0800P-M12	M8 connector LKHA-0800P-M8	e. g.
Input Byte 0	Bit 0	P1.Pin4	P1.Pin4	I 0.0
	Bit 1	P1.Pin2	P2.Pin4	I 0.1
	Bit 2	P2.Pin4	P3.Pin4	I 0.2
	Bit 3	P2.Pin2	P4.Pin4	I 0.3
	Bit 4	P3.Pin4	P5.Pin4	I 0.4
	Bit 5	P3.Pin2	P6.Pin4	I 0.5
	Bit 6	P4.Pin4	P7.Pin4	I 0.6
	Bit 7	P4.Pin2	P8.Pin4	I 0.7

2) 4 DI 4 DO module LKHA-0404P-M8

This module takes 1 byte of input and 1 byte of output, but since each signal has only 4 pins, the input signal occupies I 0.0 ~ I 0.3, the rest I 0.4 ~ I 0.7 is useless, and the output signal occupies Q 0.4 ~ Q 0.7, the rest Q 0.0 ~ Q 0.3 is useless.

Byte	Bit	M8 connector LKHA-0404P-M8	e. g.
Input Byte 0	Bit 0	P1.Pin4	I 0.0
	Bit 1	P2.Pin4	I 0.1
	Bit 2	P3.Pin4	I 0.2
	Bit 3	P4.Pin4	I 0.3
Output Byte 0	Bit 4	P5.Pin4	Q 0.4
	Bit 5	P6.Pin4	Q 0.5
	Bit 6	P7.Pin4	Q 0.6
	Bit 7	P8.Pin4	Q 0.7

3) 8DI/ DO module LKHA-08UP-M12, LKHA-08UP-M8

The module occupies 8 bits for input and 8 bits for output; I-address and Q-address are configurable according to actual application, and the rest addresses are useless. E.g. two signals of first interface are used as input, then I 0.0 and I 0.1 are occupied; Q 0.0 and Q 0.1 are useless.

Byte	Bit	M12 connector LKHA-0800P-M12	M8 connector LKHA-0800P-M8	e. g.
Input/Output Byte 0	Bit 0	P1.Pin4	P1.Pin4	I 0.0 Q 0.0
	Bit 1	P1.Pin2	P2.Pin4	I 0.1 Q 0.1
	Bit 2	P2.Pin4	P3.Pin4	I 0.2 Q 0.2
	Bit 3	P2.Pin2	P4.Pin4	I 0.3 Q 0.3
	Bit 4	P3.Pin4	P5.Pin4	I 0.4 Q 0.4
	Bit 5	P3.Pin2	P6.Pin4	I 0.5 Q 0.5
	Bit 6	P4.Pin4	P7.Pin4	I 0.6 Q 0.6
	Bit 7	P4.Pin2	P8.Pin4	I 0.7 Q 0.7

4) 16 DI module LKHA-1600P-M12, LKHA-1600N-M12

This module takes 2 bytes of input.

Byte	Bit	M12 connector	e. g.
Input Byte 0	Bit 0	Port1.Pin4	I 0.0
	Bit 1	Port1.Pin2	I 0.1
	Bit 2	Port2.Pin4	I 0.2
	Bit 3	Port2.Pin2	I 0.3
	Bit 4	Port3.Pin4	I 0.4
	Bit 5	Port3.Pin2	I 0.5
	Bit 6	Port4.Pin4	I 0.6
	Bit 7	Port4.Pin2	I 0.7
Input Byte 1	Bit 0	Port5.Pin4	I 1.0
	Bit 1	Port5.Pin2	I 1.1
	Bit 2	Port6.Pin4	I 1.2
	Bit 3	Port6.Pin2	I 1.3
	Bit 4	Port7.Pin4	I 1.4
	Bit 5	Port7.Pin2	I 1.5
	Bit 6	Port8.Pin4	I 1.6
	Bit 7	Port8.Pin2	I 1.7

5) 8 DI + 8 DO module LKHA-0808P-M12

This module takes 1 byte of input and 1 byte of output.

Byte	Bit	M12 connector	e. g.
Input Byte 0	Bit 0	Port1.Pin4	I 0.0
	Bit 1	Port1.Pin2	I 0.1
	Bit 2	Port2.Pin4	I 0.2
	Bit 3	Port2.Pin2	I 0.3
	Bit 4	Port3.Pin4	I 0.4
	Bit 5	Port3.Pin2	I 0.5
	Bit 6	Port4.Pin4	I 0.6
	Bit 7	Port4.Pin2	I 0.7
Output Byte 0	Bit 0	Port5.Pin4	Q 0.0
	Bit 1	Port5.Pin2	Q 0.1
	Bit 2	Port6.Pin4	Q 0.2
	Bit 3	Port6.Pin2	Q 0.3
	Bit 4	Port7.Pin4	Q 0.4
	Bit 5	Port7.Pin2	Q 0.5
	Bit 6	Port8.Pin4	Q 0.6
	Bit 7	Port8.Pin2	Q 0.7

6) 16 DI/DO module LKHA-16UP-M12, LKHA-16UN-M12

The module occupies 16 bits for input and 16 bits for output; I-address and Q-address are configurable according to actual application, and the rest addresses are useless. E.g. two signals of first interface are used as input, then I 0.0 and I 0.1 are occupied; Q 0.0 and Q 0.1 are useless.

Byte	Bit	M12 connector	e. g.
Input/Output Byte 0	Bit 0	Port1.Pin4	I 0.0 Q 0.0
	Bit 1	Port1.Pin2	I 0.1 Q 0.1
	Bit 2	Port2.Pin4	I 0.2 Q 0.2
	Bit 3	Port2.Pin2	I 0.3 Q 0.3
	Bit 4	Port3.Pin4	I 0.4 Q 0.4
	Bit 5	Port3.Pin2	I 0.5 Q 0.5
	Bit 6	Port4.Pin4	I 0.6 Q 0.6
	Bit 7	Port4.Pin2	I 0.7 Q 0.7
Input/Output Byte 1	Bit 0	Port5.Pin4	I 1.0 Q 1.0
	Bit 1	Port5.Pin2	I 1.1 Q 1.1
	Bit 2	Port6.Pin4	I 1.2 Q 1.2
	Bit 3	Port6.Pin2	I 1.3 Q 1.3
	Bit 4	Port7.Pin4	I 1.4 Q 1.4
	Bit 5	Port7.Pin2	I 1.5 Q 1.5
	Bit 6	Port8.Pin4	I 1.6 Q 1.6
	Bit 7	Port8.Pin2	I 1.7 Q 1.7

4.4 Module Startup Process

Check whether the following requirements are met for the startup of the Compact67 series IO-Link module:

- IO-Link master and sensor hub are power, bus and signal wired.
- The module address is set by software.
- Compact67 module is configured and downloaded into the controller.
- Supply voltage for controller is switched on.

Startup of Compact67 module:

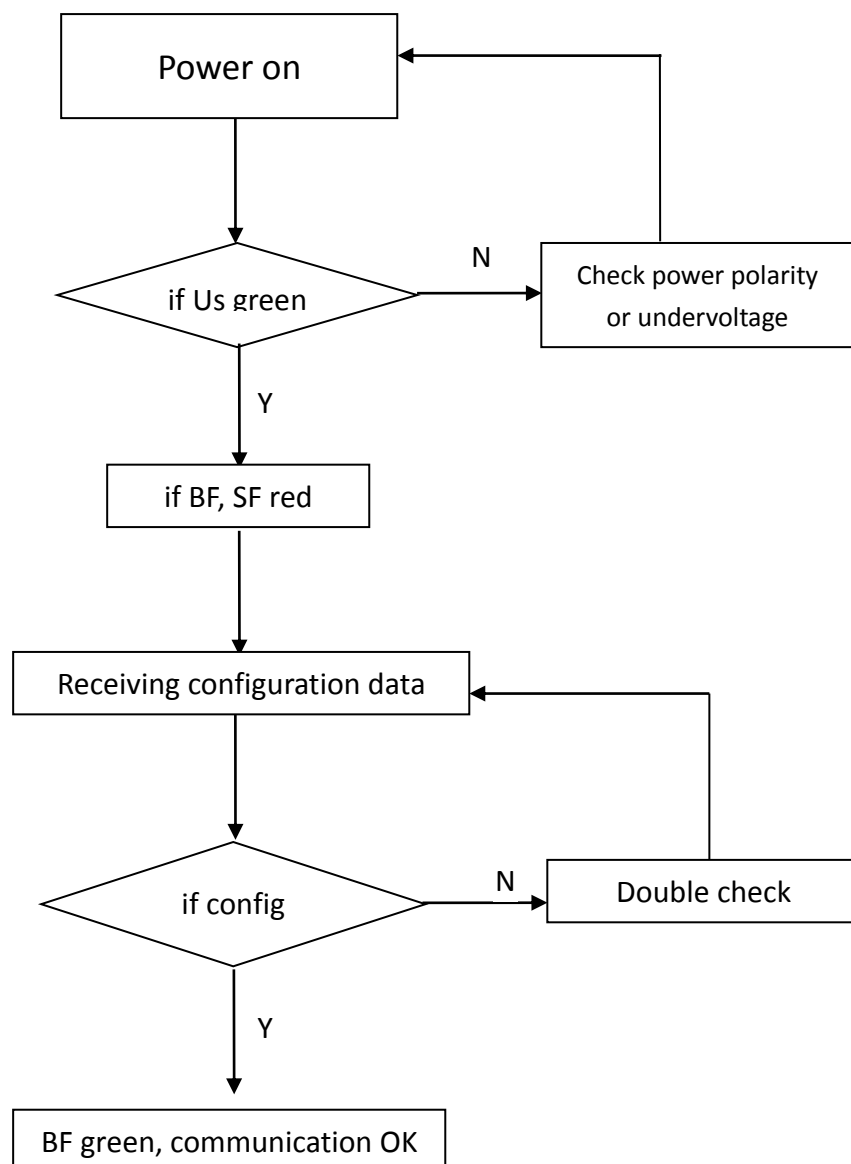

4.5 Module configuration by Portal

This section, through a case of connection configuration in a current operation process, will let the users fully understand how to use the Compact67 series IO-Link module. In this case, using the ELCO Compact67 IO-link master as PROFINET slave to connect the Siemens PROFINET controller CPU1211C under the condition that all power and bus connections have been completed, the device name of IO-Link master module is assigned as elco67.

Compact67 IO-link system includes a master module FCPN-8LKM-4A4B, the master IO-Link port P1 connecting one IO-Link hub LKHA-0800P-M8; IO-Link port P5 connecting one IO-Link hub LKHB-0808P-M12.

The following will show the specific process of software configuration and debugging.

1) Create a new Portal project

Open Portal software, click "Create New Project", change "Project Name" to "IO-link", select the save path, and click "Create".

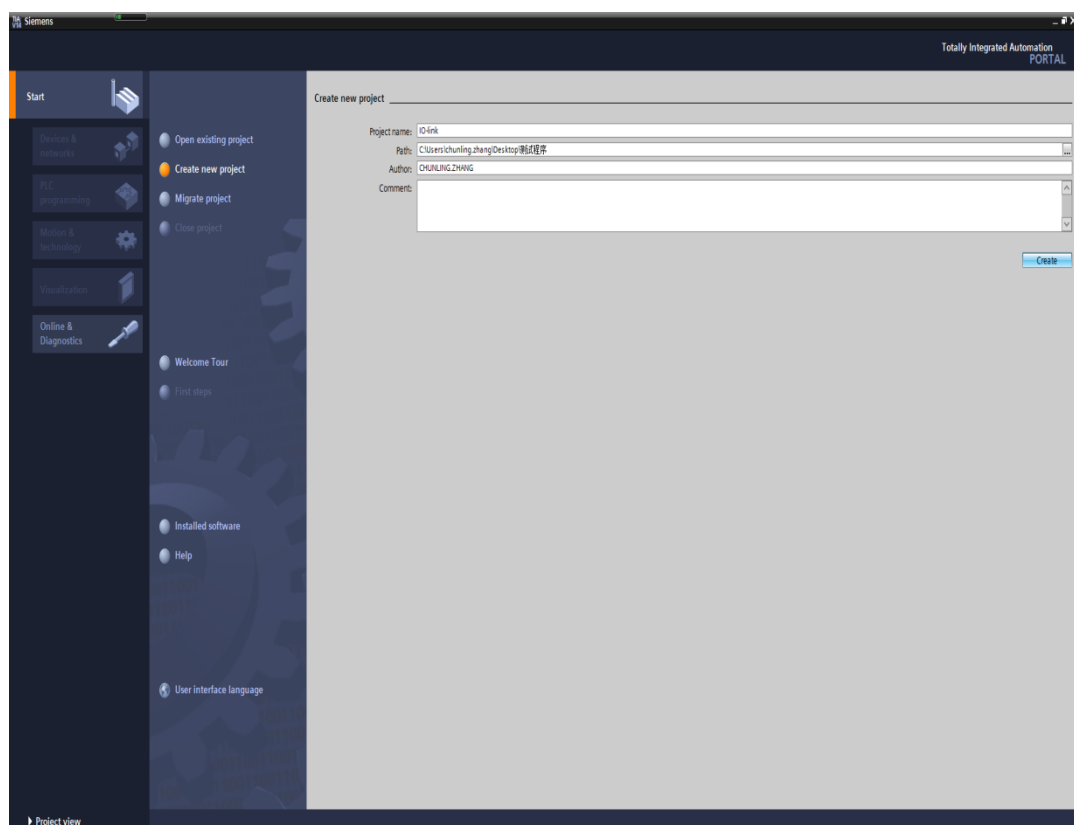

2) Install GSD files for ELCO Compact67 IO-link products.

a) Select "Options"->"Manage General Station Description File (GSD)" in the menu bar.

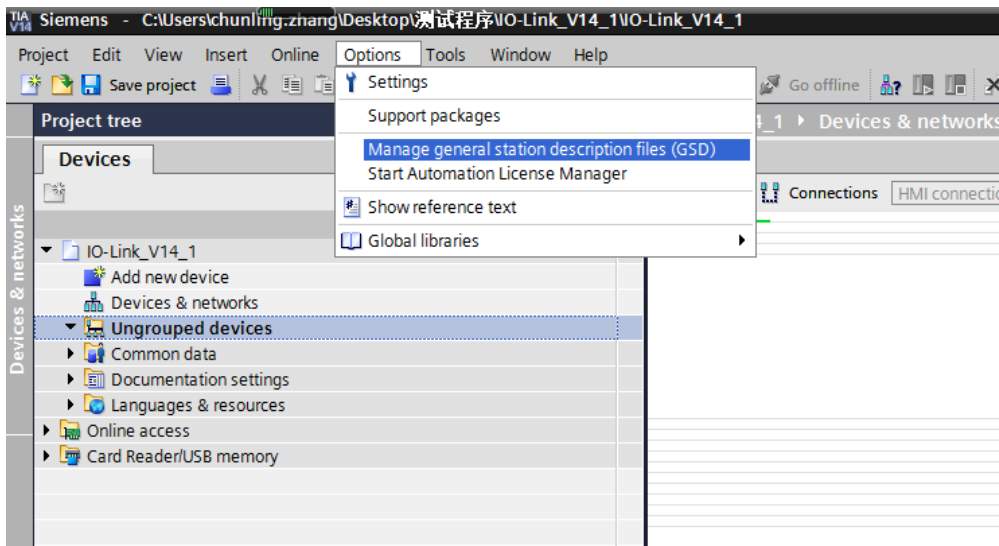

b) Select the version of the GSD file to be imported and click 'Install'.

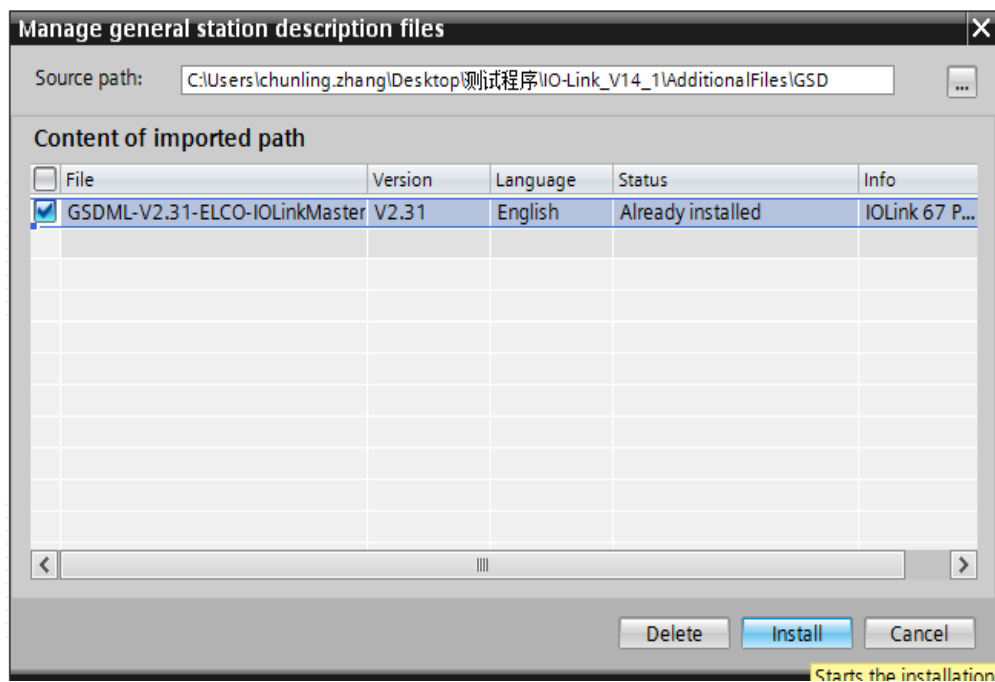

3) Double-click "Add New Device" on the left and select the PLC model in the "Controller" window.

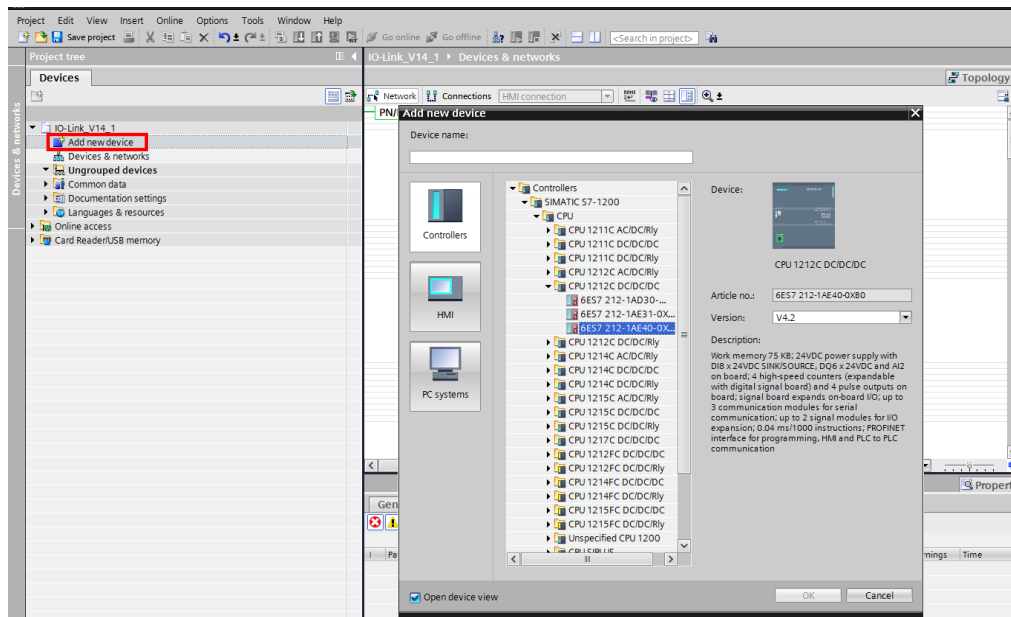

4) Double-click the "Device Configuration" window on the left, and in the "Network View" window, select "Properties" -> "PROFINET Interface [X1]" -> "Ethernet Address" and set the IP address of the PLC.

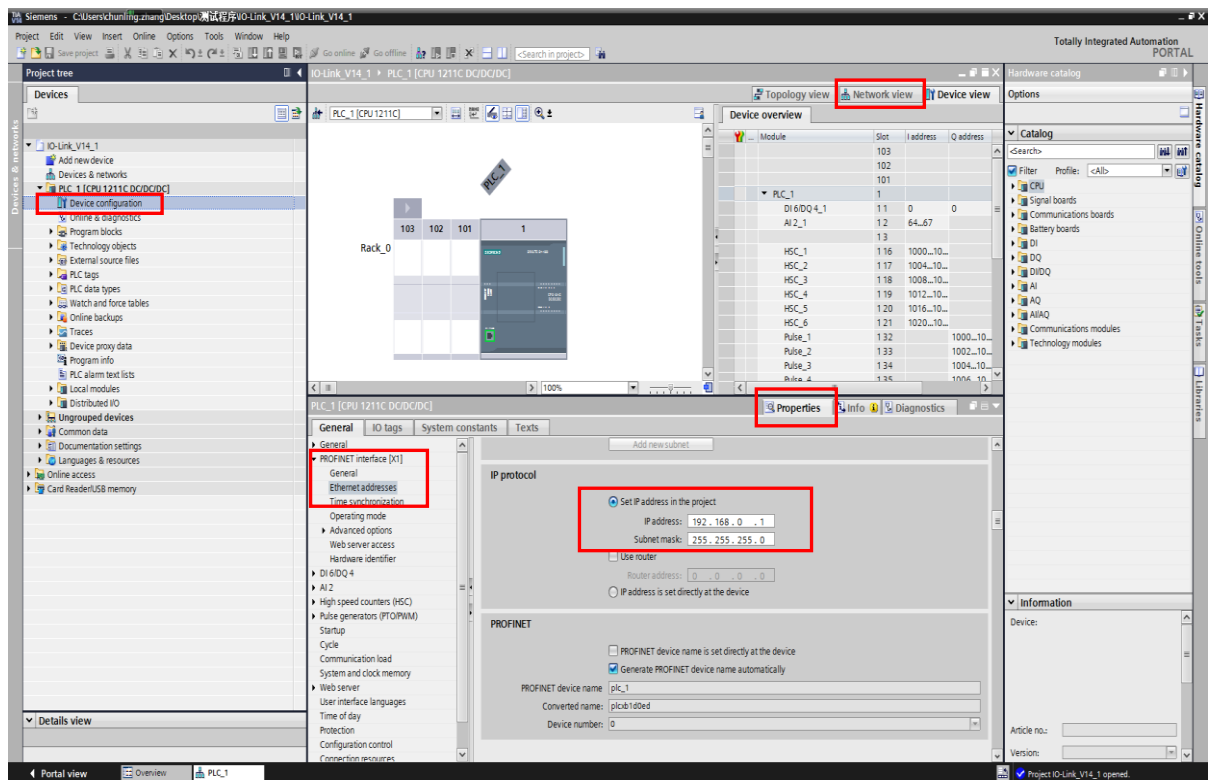

5) Add IO-Link master module and communicate with PLC

- a) Double-click "Devices & Networks" on the left to enter the "Network View" interface and select FCPN-8LKM-4A4B through "Other Field Devices-> PROFINET IO-> I / O-> ELCO-> IOlink67 Master-> IOLINK67 Gateway Module" in "Hardware Catalog", double-click or drag to add to the network.

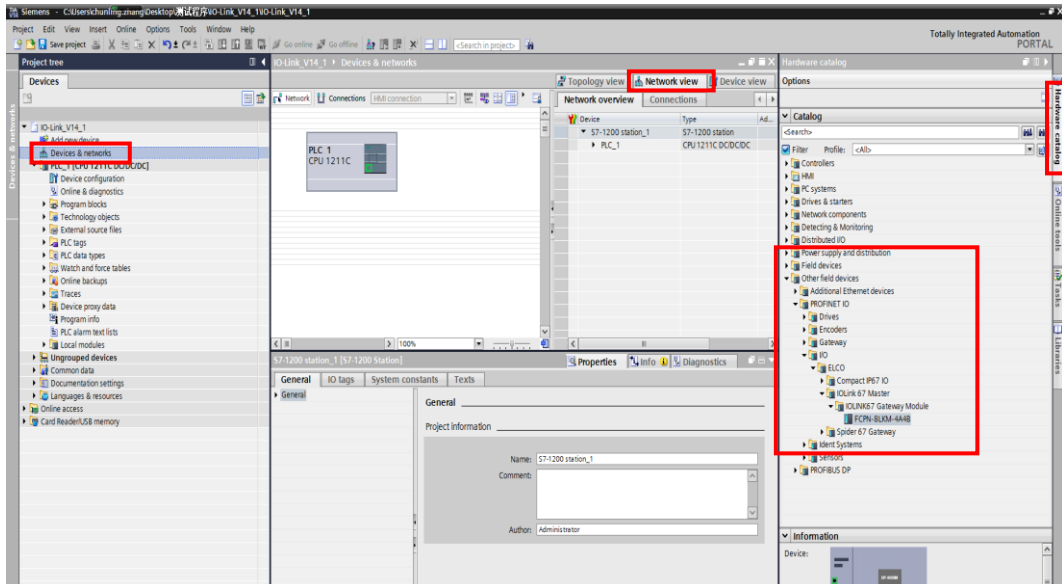

- b) Click the "Not assigned" hyperlink and click to select "PLC_1.PROFINET Interface_1"

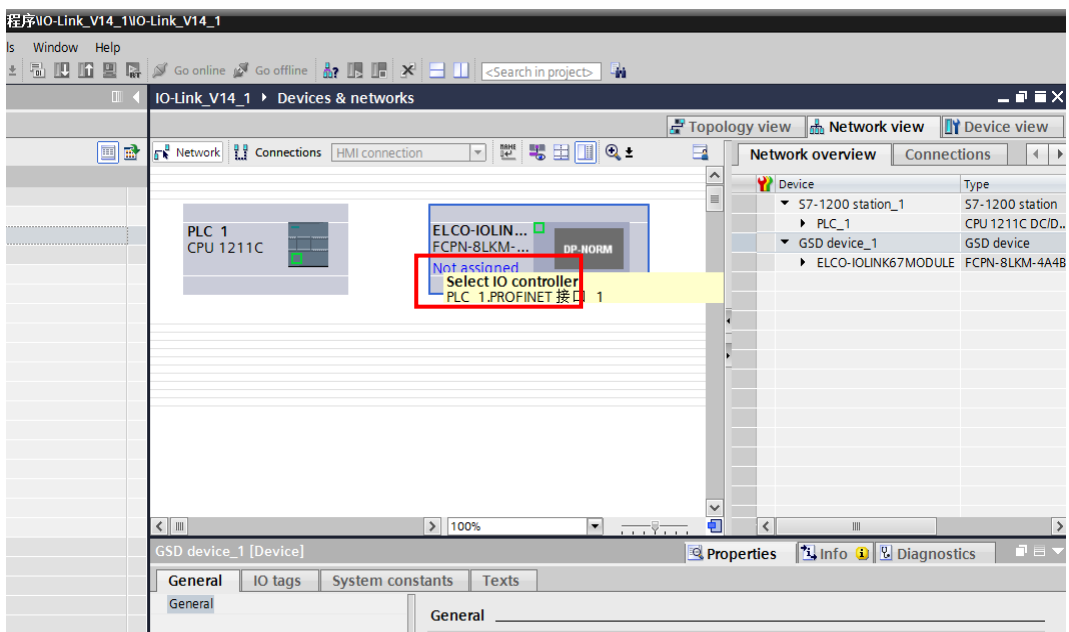

c) Compact67 IO-link master and PLC complete communication connection.

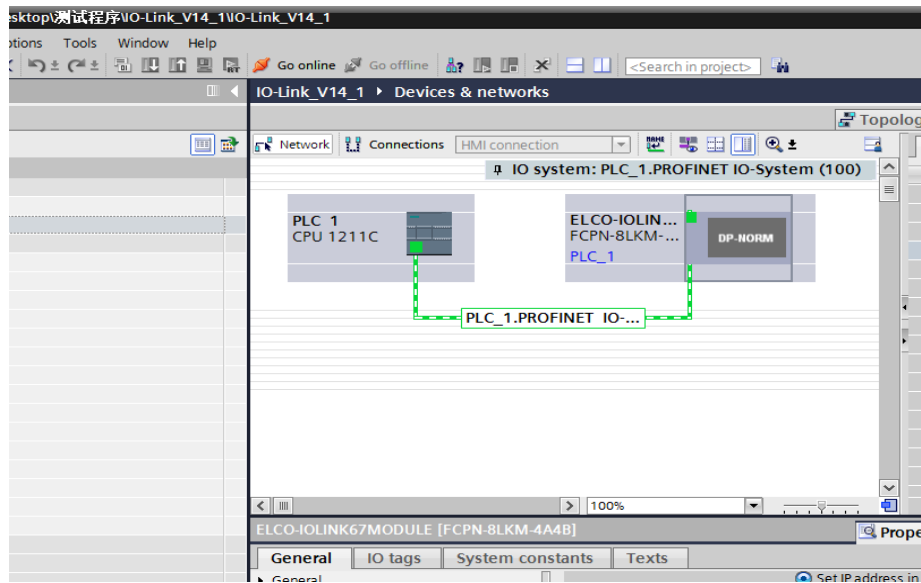

6) Modify IO-Link master module device name and IP address settings

a) Click the IO-Link master module in the "Network View", select "Properties->PROFINET Interface-> Ethernet Addresses", set the IO-Link master module device name elco67 in the window, and set the IP address. (It should be on the same network segment as the IP address of the PLC)

b) Click "Online Access" in the "Project Tree" on the left, find the name of the upper computer network card, double-click "Update accessible devices", and then the name and MAC address of the connected IO-Link master module will be scanned. Double-click " Online and Diagnostics ", modify the device name to elco67 in this interface.

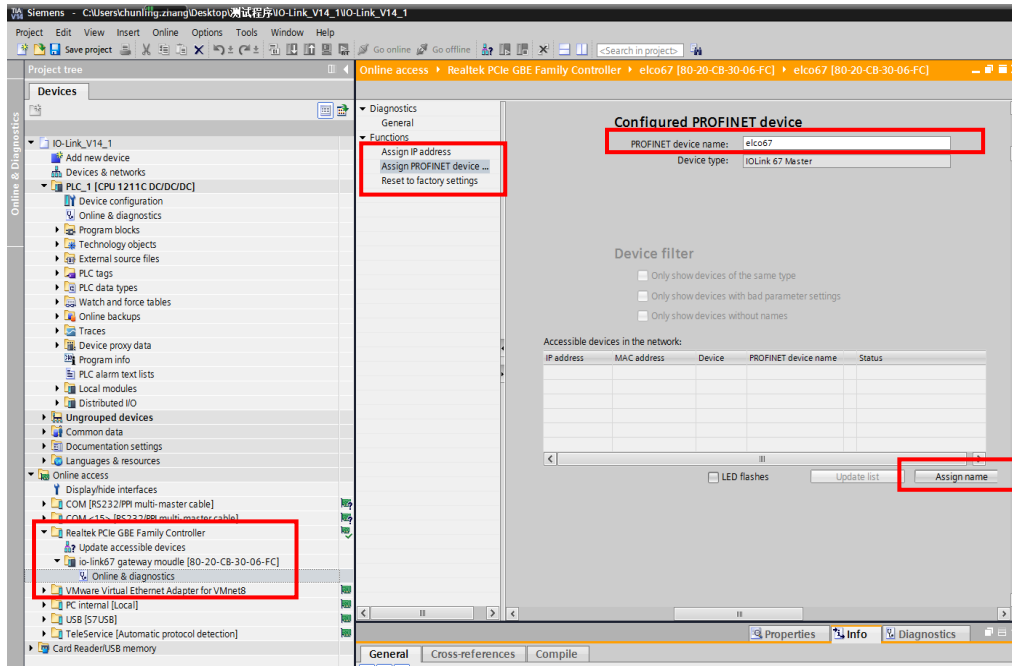

Note: The name of the IO-Link master module must be the same as the device name modified in the previous step.

7) Enter the "Device View" interface and select "Attributes-> General-> Module Parameters" of "IOLINK Fixed 8 Input / Output_1". At this time, the user can modify the module parameters.

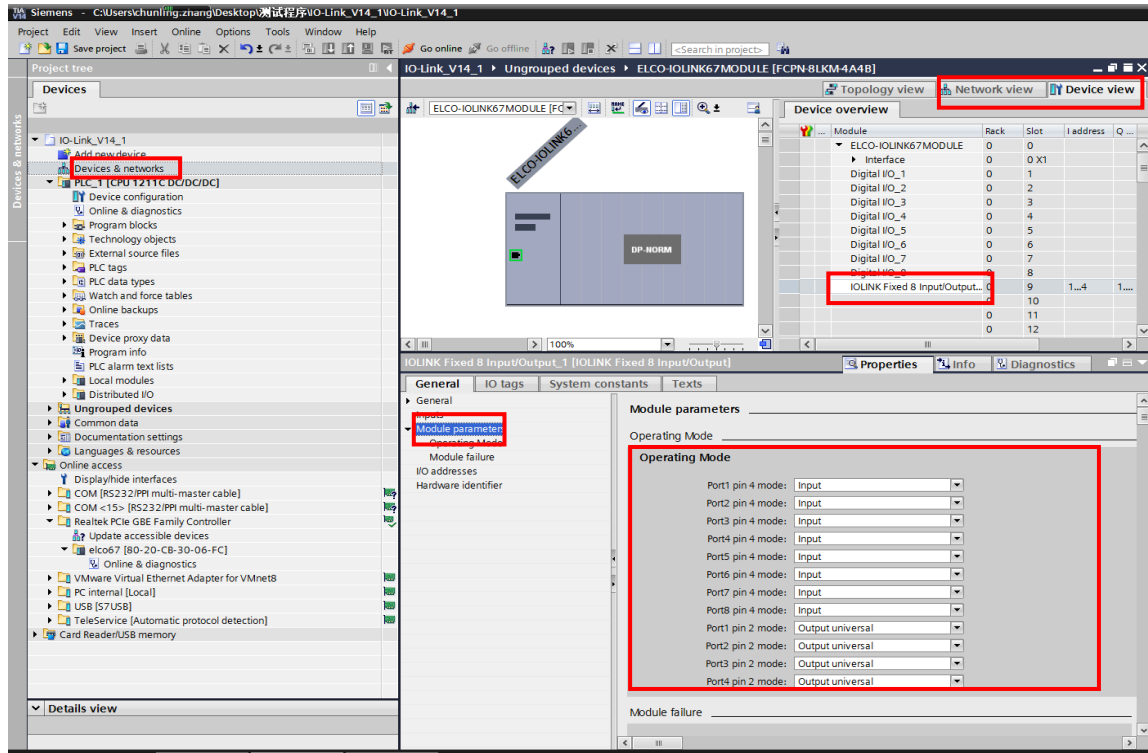

For the Compact67 IO-link master FCPN-8LKM-4A4B, pin 4 of Port 1 ~ Port 8 has three working modes: "Input", "Output" and "IO-Link" for users to choose. Pin2 of Port1 ~ Port8 has three working modes: "Input", "Output" and "Output universal" for users to choose.

8) According to the configuration of the IO-link module provided at the beginning of this section, the expansion ports P1 and P5 need to be changed to the IO-link working mode.

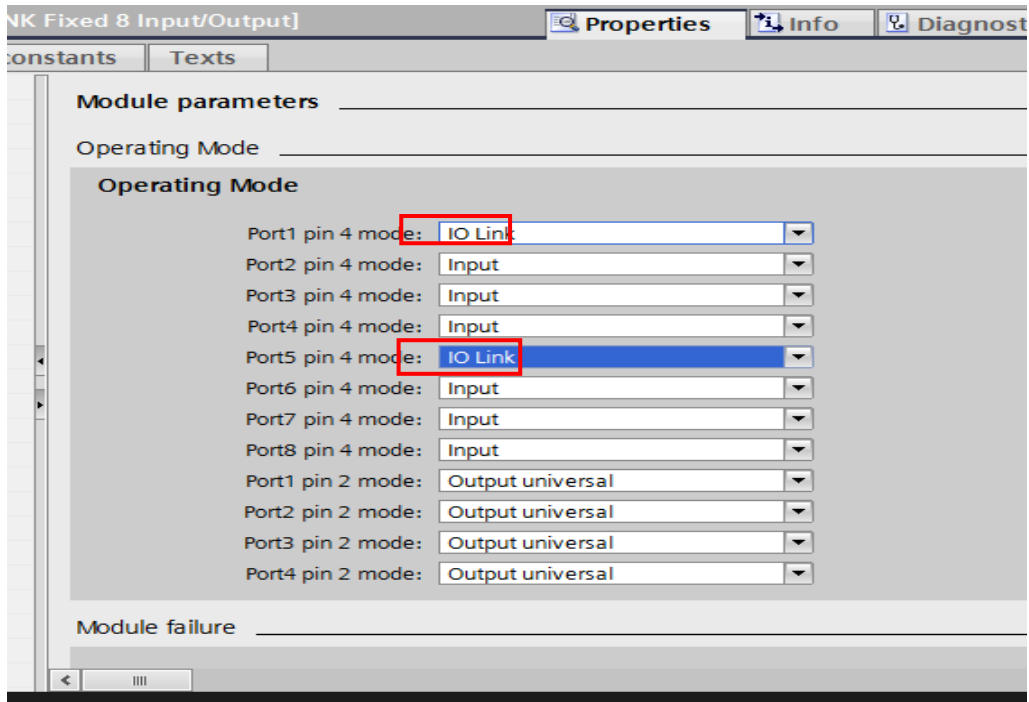

9) Add the IO-Link sensor hub module to the Device Overview

- a) Delete "Digital I / O_1" in the "Device Overview" first.
- b) Select "Module-> ELCO IO-Link Device Module-> LKHA-0800P-M8" module in the "Hardware Catalog" window and drag it to the corresponding position.

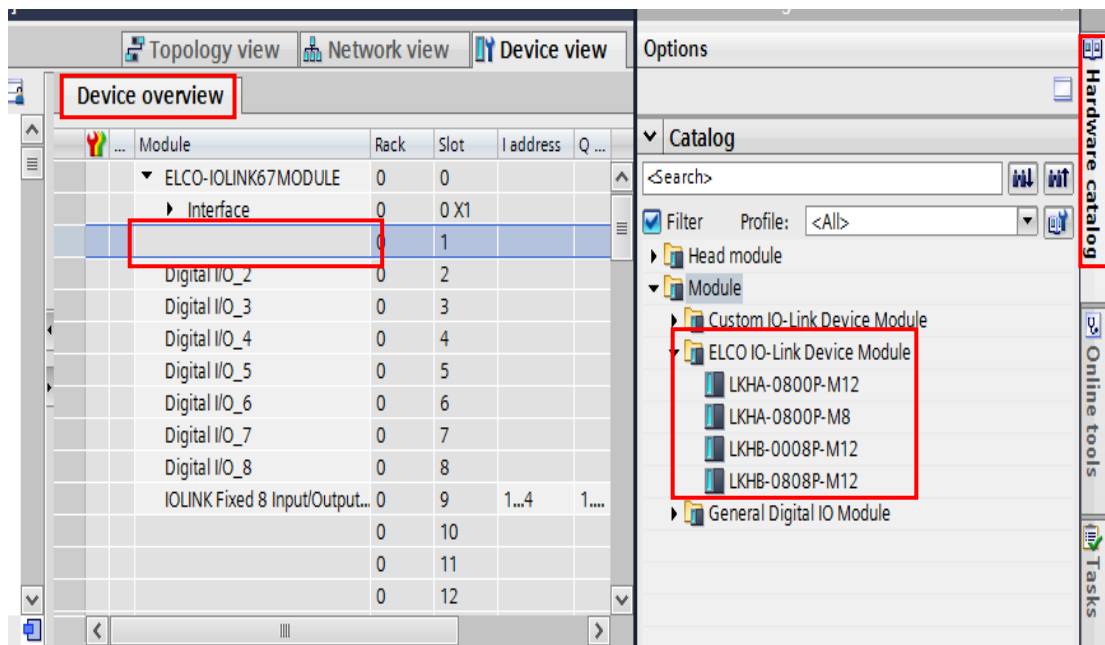

c) Repeat steps a and b to add a "LKHB-0808P-M12" slave module to the P5 expansion port.

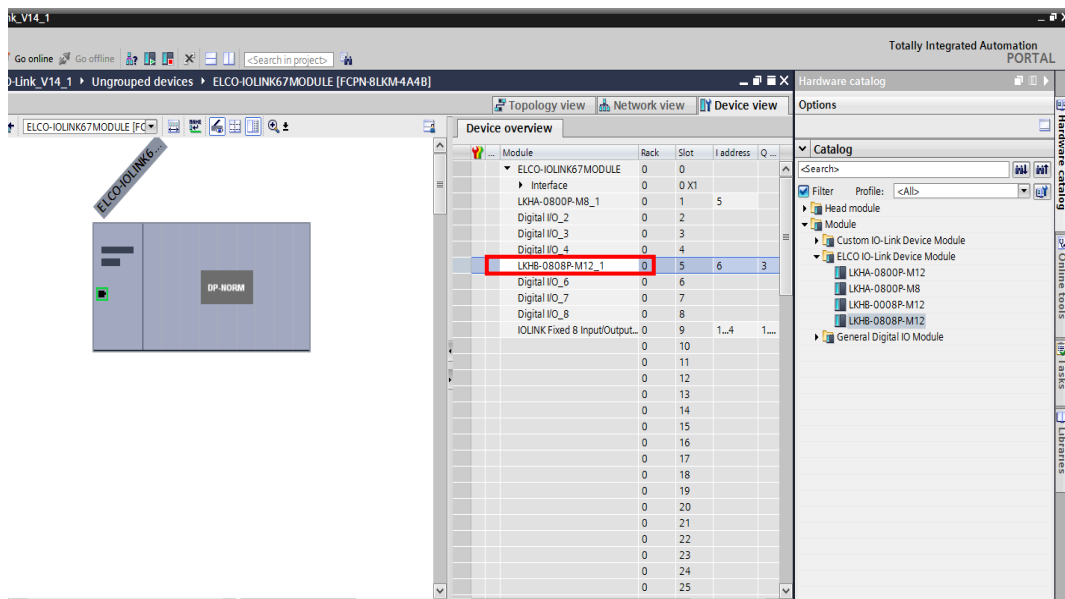

10) After saving and compiling, download the configuration to the PLC.

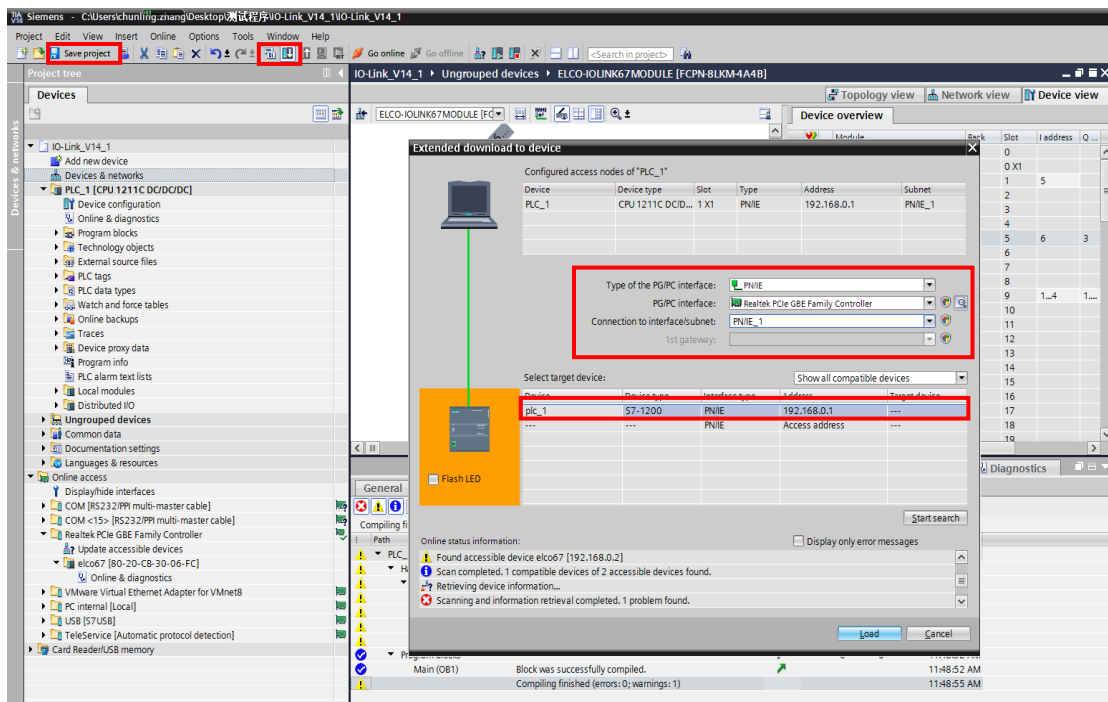

11) When the P1 and P5 expansion ports of the IO-Link master module are constantly yellow and BF indicator is green on, the configuration is successful.

5. Alarm diagnosis

5.1 LED fault indicator

With the LED indicator on the Compact67 series IO-Link module, users can easily and quickly determine the current working status of the module. (For the appearance of the indicator, please refer to Section 2.5 "LED Indication Function")

IO-Link master indicator

Name	Status	Meaning	Fault cause
Expansion channel Indicator IO-Link	Yellow	IO-Link connection OK	-
	Green	Ordinary digital signal	-
	Yellow flash	No IO-Link connection	Check the IO-Link cable connection
	Red	1. Short circuit 2. Output signal overload	1. Check the cable connection 2. Module channel is damaged
	Red flash	IO-Link connection incorrect	1. Check the configuration 2. Check IO-Link device status
Gateway status Indicator SF	Green	Work normally	-
	Red	Working abnormally	1. Power supply is abnormal 2. Channel abnormal (short circuit, overload, etc.) 3. Module is damaged
Network status Indicator BF	Green	Communication normal	-
	Red	Communication abnormal	1. Network cable failure 2. Check the configuration 3. Module is damaged
Profinet network status Indicator Lk1, 2	Green	Connected to the network	-
	Orange	Not connected to the network	1. Network cable failure 2. Module is damaged
	Orange flash	Network data is exchanging	Check configuration
Power supply Indicator Us, Ua	Green	Supply voltage normal	-
	Red	Supply voltage abnormal	1. Overvoltage or undervoltage 2. Module is damaged
	Off	No power supply	1. Power supply cable failure 2. Module is damaged

IO-Link sensor hub indicator

Name	Status	Meaning	Fault cause
Module communication Indicator P	Green flash	Receive IO-Link communication	-
	Off	No IO-Link signal received	1.Expansion cable failure 2.Master IO-Link port problem 3.Slave module is damaged
Signal / status Indicator	Red	Abnormal signal	1.Signal overload or short circuit 2.Slave module is damaged
	Green	Have signal	-
	Off	No signal	-

5.2 Process image area of IO-Link Master

Different types of modules occupy different process image areas of PLC, as follows:

1) 8 ports IO-Link interface (4*Class-A + 4*Class-B) , FCPN-8LKM-4A4B

IN=4 bytes , OUT=2 bytes

IN	Byte	Bit_7	Bit_6	Bit_5	Bit_4	Bit_3	Bit_2	Bit_1	Bit_0
Signals	0	P4.Pin2	P4.Pin4	P3.Pin2	P3.Pin4	P2.Pin2	P2.Pin4	P1.Pin2	P1.Pin4
	1	-	P8.Pin4	-	P7.Pin4	-	P6.Pin4	-	P5.Pin4
Status	2	Err_P8	Err_P7	Err_P6	Err_P5	Err_P4	Err_P3	Err_P2	Err_P1
	3	Ua Over vol.	Ua Under vol.	Us Over vol.	Us Under vol.	Ua Short cir.	-	-	-
OUT	Byte	Bit_7	Bit_6	Bit_5	Bit_4	Bit_3	Bit_2	Bit_1	Bit_0
Signals	0	P4.Pin2	P4.Pin4	P3.Pin2	P3.Pin4	P2.Pin2	P2.Pin4	P1.Pin2	P1.Pin4
	1	-	P8.Pin4	-	P7.Pin4	-	P6.Pin4	-	P5.Pin4

2) 8 ports IO-Link interface (8*Class-A) , FCPN-8LKM-8A

IN=4 bytes , OUT=2 bytes

IN	Byte	Bit_7	Bit_6	Bit_5	Bit_4	Bit_3	Bit_2	Bit_1	Bit_0
Signals	0	P4.Pin2	P4.Pin4	P3.Pin2	P3.Pin4	P2.Pin2	P2.Pin4	P1.Pin2	P1.Pin4
	1	P8.Pin2	P8.Pin4	P7.Pin2	P7.Pin4	P6.Pin2	P6.Pin4	P5.Pin2	P5.Pin4
Status	2	Err_P8	Err_P7	Err_P6	Err_P5	Err_P4	Err_P3	Err_P2	Err_P1
	3	Ua Over vol.	Ua Under vol.	Us Over vol.	Us Under vol.	Ua Short cir.	-	-	-
OUT	Byte	Bit_7	Bit_6	Bit_5	Bit_4	Bit_3	Bit_2	Bit_1	Bit_0
Signals	0	P4.Pin2	P4.Pin4	P3.Pin2	P3.Pin4	P2.Pin2	P2.Pin4	P1.Pin2	P1.Pin4
	1	P8.Pin2	P8.Pin4	P7.Pin2	P7.Pin4	P6.Pin2	P6.Pin4	P5.Pin2	P5.Pin4

3) 4 ports IO-Link interface (4*Class-A) , FCPN-4LKM-4A4S

IN=4 bytes , OUT=2 bytes

IN	Byte	Bit_7	Bit_6	Bit_5	Bit_4	Bit_3	Bit_2	Bit_1	Bit_0
Signals	0	P4.Pin2	P4.Pin4	P3.Pin2	P3.Pin4	P2.Pin2	P2.Pin4	P1.Pin2	P1.Pin4
	1	P8.Pin2	P8.Pin4	P7.Pin2	P7.Pin4	P6.Pin2	P6.Pin4	P5.Pin2	P5.Pin4
Status	2	Err_P8	Err_P7	Err_P6	Err_P5	Err_P4	Err_P3	Err_P2	Err_P1
	3	Ua Over vol.	Ua Under vol.	Us Over vol.	Us Under vol.	Ua Short cir.	-	-	-
OUT	Byte	Bit_7	Bit_6	Bit_5	Bit_4	Bit_3	Bit_2	Bit_1	Bit_0
Signals	0	P4.Pin2	P4.Pin4	P3.Pin2	P3.Pin4	P2.Pin2	P2.Pin4	P1.Pin2	P1.Pin4
	1	P8.Pin2	P8.Pin4	P7.Pin2	P7.Pin4	P6.Pin2	P6.Pin4	P5.Pin2	P5.Pin4