

NOVAKON



NOVAKON

NOVAKON Co., Ltd.

Bldg. F, 15F, No.3, Yuan Qu St. Nangang

Dist., Taipei, Taiwan 115603 R.O.C.

Tel : +886-2-7720-0999

E-mail : sales@novakon.com.tw



Product Catalog



CONTENTS

Company Profile	03
Applications	07
IIOT Solutions	09
Software	
iFace Designer®	11
iM Connect®	15
Custom Software Services	19
Hardware	
Product Overview	21
HMI	27
Industrial Panel PC	37
Protocol Conversion Gateway	49
Protocol Conversion Card	50
Embedded Box PC	51
PLC Support List	53

NOVAKON IIoT Solutions

Bridging the OT and IT systems



About NOVAKON

Drive Digital Transformation and Shape the Future

Novakon Co., Ltd. is a dedicated HMI (Human-Machine Interface) and IIoT (Industrial Internet of Things) software developer and hardware manufacturer, our exceptional customized services provide clients with a wide array of software tailor-made solutions that facilitate unique day-to-day operations without compromise. Over two decades of experience across a vast array of application verticals enables Novakon to offer robust integration services linking data from legacy devices with modern databases.

Company

Founded
September, 2010

Parent Group
iBASE
Technology Inc.
(TPEX 8050)

Solution

Software
HMI / SCADA Software – iFace-Designer®
Industrial Protocol Conversion Software – iM-Connect®

Hardware
HMI Control Panel
Industrial Panel PC
Industrial IOT Gateway
ARM-based mainboard & Box PC

Service
Integration and custom
software service

NOVAKON Core Competence

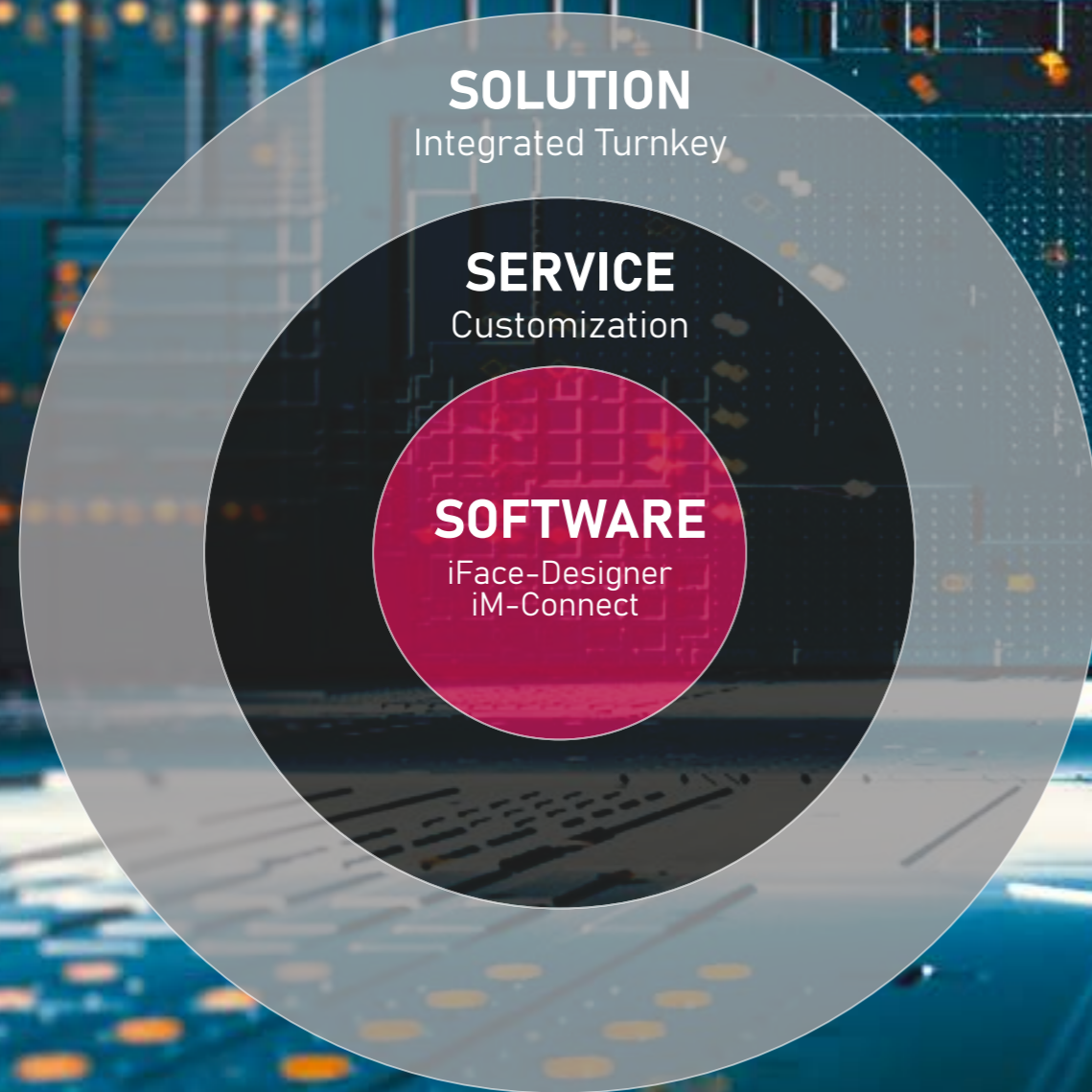

- iFace-Designer® – HMI Visualization
- iM-Connect® – IIoT Protocol Conversion

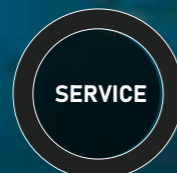

- Software / Hardware
- Application Customization
- Legacy upgrade & replacement



- Industry domain know-how
- Hardware and software integration

Novakon Focused Area

Computer Integrated Manufacturing

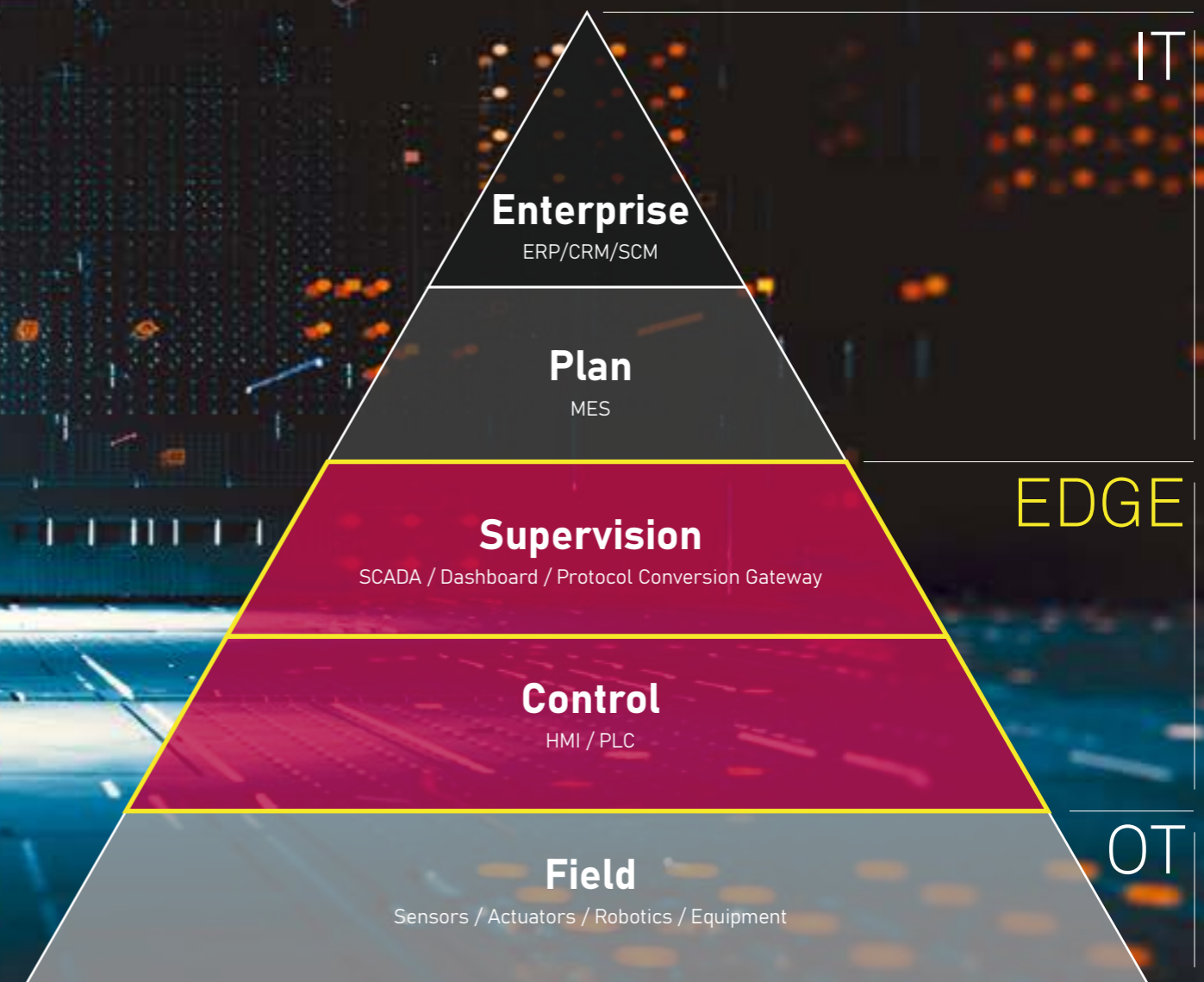

Novakon focuses on the edge layer of CIM pyramid for IT/OT convergence. In addition to delivering SCADA and HMI solutions in CIM control and supervision layers, we also provides ideal solutions and customized services for protocol conversion gateway used for data collection as well as dashboard used for enterprise situation room.



Data Center
Power Metering

Application Stories

Novakon is the professional HMI solution provider. We offer products and solutions with proven track of records in various industries and vertical applications, including data center power metering, indoor environmental monitoring, building automation, retail store equipment management, pneumatic torque controller, CNC machine, wastewater treatment, IIoT sewing machine, and all kinds of production and process automation machinery, devoted to create a reliable and flexible interface that connects your facilities or business environments to the Industrial IoT ecosystem.

Learn more about our application stories at www.novakon.com.tw



IIoT Sewing
Machine



CNC
Machine



Indoor
Environmental
Monitoring



Pneumatic Torque
Controller



Wastewater
Treatment



Retail Store
Equipment
Management



Building
Automation



Production
Equipment

IIoT Solutions

HMI • Industrial Panel PC • Protocol Conversion Gateway • ARM-based Mainboard



OT

Visualization



Data Acquisition

IT



Programmable Logic Controller



Robotics



CNC Controller



Meter



I/O Module



HVAC



Environmental Sensors



Motor



Machine Tool

iFace-Designer®

Intuitive, **F**unctionality, **A**esthetic, **C**onfigurable, **E**asy

iFace Designer® is a cross-platform visualization software, from which the compiled program can be installed and run on both HMI and Industrial Panel PC. Tabs in ribbon UI make it simple and straightforward to develop projects. With a few clicks you can easily reach functions and properties.

01 Quick Toolbar

Small custom toolbar which can include more frequently used commands.

02 File Tab

A file menu with functions for project management.

03 Screen Tab

Quickly alternate between screens for editing.

04 Screen Manager

Screen can be clicked on for editing, viewing, summarizing current content.

05 Screen Editing Area

Edit the content of each screen in the project

06 Sub-Window Shortcuts

Quick commands to open or to close sub-windows.

07 Multi-language & Widget states

Choose from multiple languages and control states to view and to edit.



08 Software Interface Settings

Change the skins or languages for GUI.

09 Ribbon

The ribbon contains multiple tabs with groups of functions for editing convenience and project management.

10 System Widget Library

A rich and elaborate widget library for user to choose from.

11 User Widget Library

User can also easily create a customized library of widgets.

12 Compiled Results

Compilation error messages appear in this window so that user can quickly debug.

13 Zoom, Grid, and Coordinates

Zoom in or out screens for perfect viewing. Grid and Coordinates for quickly and easily positioning of the widgets on screen.

Diversified Smart Functions

iFace Designer[®] provides smart and powerful functions for visualization, automation, IIoT remote communication and monitoring.

Widget Library

Built-in library of refreshingly designed, easy to use widgets, elegant and stylish.

Statistics Charts

Display data logs with charts with a variety of line types and backgrounds.

CODESYS PLC Handler

Built-in PLCHandler for the communication between CODESYS Soft PLCs controller and HMI. CODESYS symbol .xml file import supported.

MQTT

Support both MQTT (Message Queuing Telemetry Transport) server and client for message exchange between publisher and subscriber.

Macro

Powerful yet simple scripting language for data manipulation, data conversion, and data movement.

Trigger Action

According to the programmed conditions to trigger associated actions and alarms.

PLC Pass Through

Create a tunnel for PC to directly monitor and control PLC, upload and download PLC program to PLC through HMI without extra connection.

RESTful API

Sends requests and receives responses in JSON format while avoiding security breaches with HTTPS encryption algorithm.

Data Logger

High precision sampling time and adjustable data refresh rate. Support data with a max of 32 data fields each log.

Report

Data log backup can be further exported into reports in .txt, .csv, or .pdf formats.

VNC

Remote control and monitoring of HMI can be easily achieved through VNC connection.

OPC UA

Built-in OPC UA server and client for data exchange with standardized communication and interoperability.

Scheduler

Automatic actions according to the pre-defined schedules to increase work efficiency.

Recipe

Easy grouping parameters recipe. Each recipe data field can seamlessly link to widgets.

VPN

VPN enables all the remote control and monitoring across firewalls and networks via a secured tunnel.

Line Notify

Alarm and event messages can be sent through Line Notify when the defined condition is met.

Program Simulation

Online and offline simulation to see how your application works with/without connection to controllers right on your PC.

PLC Drivers and industrial protocols

Support standard industrial communication protocols and mainstream PLC drivers just with simple selection and settings.

FTP

Data logs, historical alarm tables, recipes, screen captures, and HMI project can be remotely upload or download via FTP.

Online Upgrade

Support software version as well as PLC driver library online upgrade.

iM-Connect®

Intelligent, Machine, Connect

iM-Connect® is a web-based and simple-to-use programming software that supports a variety of industrial communication protocols, PLC drivers, and IIOT cloud connections as a simple but reliable protocol conversion and data acquisition platform for the "Connected" industries.

01 iM-Connect Menu

Contains the directory of each iM-Connect functions.

02 Basic Settings

The setup of PLC, tag, data logger, and alarm are identical to iFace Designer. Easy hands-on across two softwares without efforts.

03 Advanced Settings

Advanced functions including MQTT, Macro, OPCUA, Online Monitor, etc.

04 Project and System Setup

Project and system related settings, such as save and compile, download/upload, start/stop of the project; System operating status, network parameters, date and time, and security settings

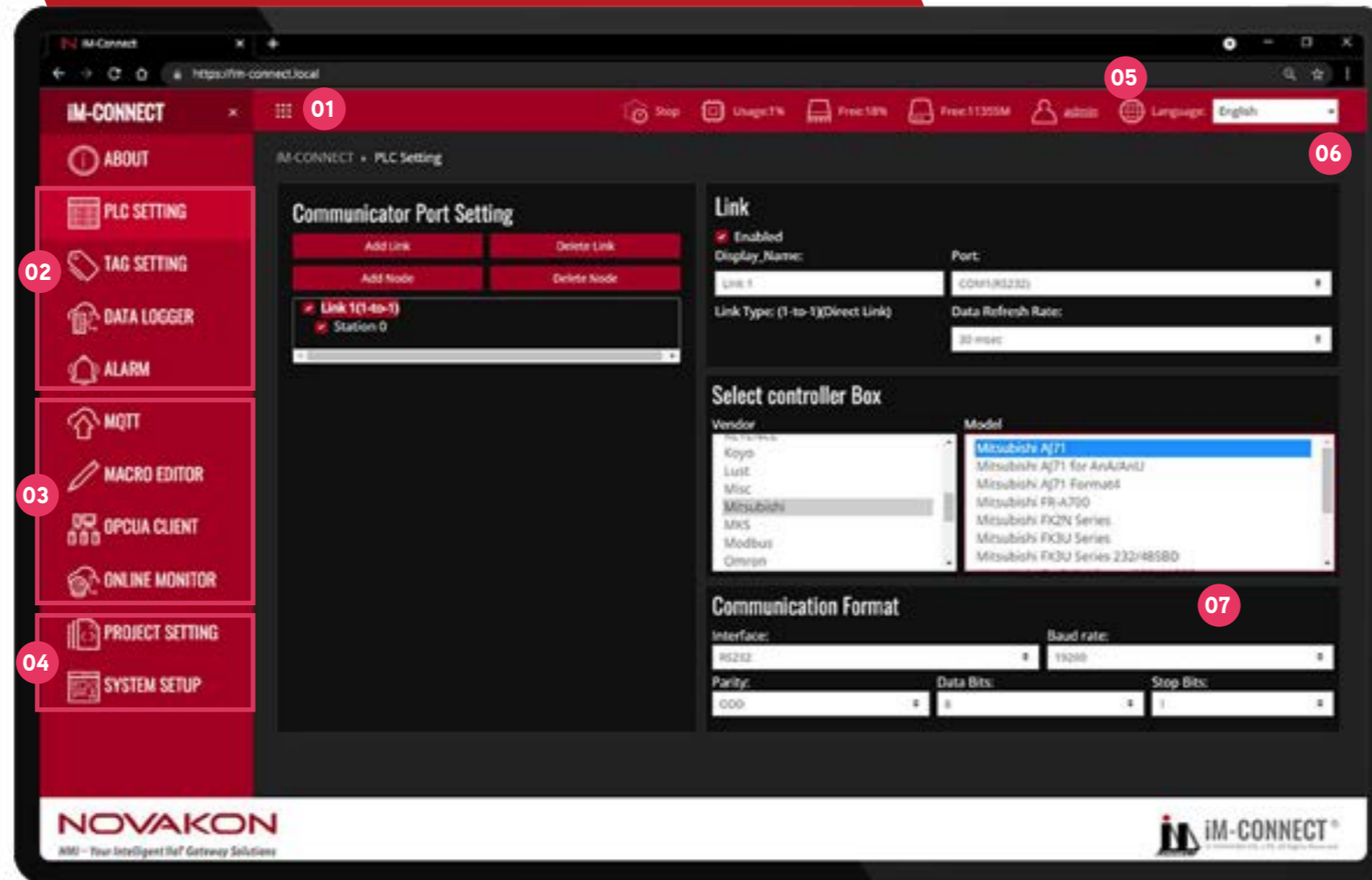

05 Gateway URL

Enter the URL into the web browser to access the iM-Connect webpage.

06 System Status Bar

View the current usage and remaining capacity of the system as well as runtime status, username and current selected language.

07 Function Setting Area

Select and configure the parameters of each functions.

Diversified Smart Functions

iM-Connect[®] offers an easy-to-use configuration interface on the web browser to empowers the hardware platform with data acquisition and protocol conversion capabilities, which helps the challenging work for legacy equipment upgrade across industries.

Data Logger

High precision sampling time and adjustable data refresh rate. Support data with a max of 32 data fields each log.

PLC Drivers and industrial protocols

Support standard industrial communication protocols and mainstream PLC drivers just with simple selection and settings.

MQTT

Support both MQTT (Message Queuing Telemetry Transport) server and client for message exchange between publisher and subscriber.

Online Monitor

Real-time monitor the current tag values and status from the controllers connected to gateway.

Report

Data log backup can be further exported into reports in .txt, .csv, or .pdf formats.

CODESYS PLC Handler

Built-in PLCHandler for the communication between CODESYS Soft PLCs controller and Gateway. CODESYS symbol .xml file import supported.

RESTful API

Sends requests and receives responses in JSON format while avoiding security breaches with HTTPS encryption algorithm.

Online Upgrade

Support software version as well as PLC driver library online upgrade.

Macro

Based on JavaScript, it's a powerful yet simple tool for data manipulation, data conversion, and data movement.

VPN

VPN enables all the remote control and monitoring across firewalls and networks possible.

OPC UA

Built-in OPC UA server and client for data exchange with standardized communication and interoperability.

Database Connection

Data log can be pushed to Databases, such as MySQL, MS SQL, and SQLite when triggered by condition or at any given interval.

Security

Login with username and password. User can be set to two different security levels for different access: administrator (modified and view) or user (view only).

FTP

Data log backup can be remotely upload or download via FTP.

Email & Line Notify

Alarm and event messages can be sent through Email and Line Notify when the defined condition is met.

SECS/GEM

Different equipment data can be collected and converted to meet Semiconductor and PCB industry specific standard.

Custom OEM / ODM Services

Servicing the industries and catering to every UNIQUE demand

Novakon is committed to providing customers with tailor-made solutions that facilitate unique day-to-day operations without compromise. We offer custom services from board level, system products, software to turnkey ODM solutions.

- Programming Services
- Application Customization Services
- Legacy Upgrade & Replacement Services

Any custom software requirement, please contact us at sales@novakon.com.tw

NOVAKON



Panel PC
NPP Series

HMI
N Series
P Series

Gateway
GW Series
GP Series

Industry IIoT Gateway

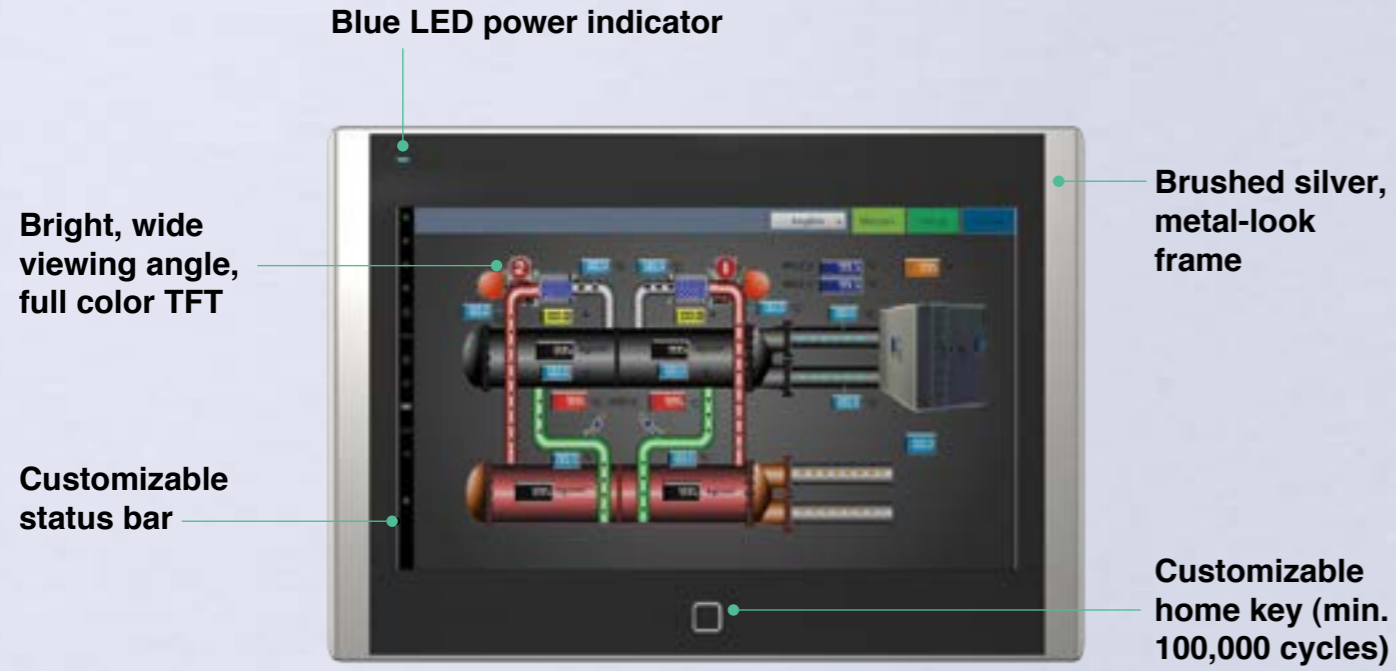

DC Power
Isolated design
24V ± 20%

GPIO

USB (master)

2x 03.2V	GPIO_02	GPIO_03
CARD	GPIO_04	GPIO_05
GPIO_06	GPIO_07	GPIO_08
GPIO_09	GPIO_10	GPIO_11
GPIO_12	GPIO_13	GPIO_14
GPIO_15	GPIO_16	GPIO_17
GPIO_18	GPIO_19	GPIO_20
GPIO_21	GPIO_22	GPIO_23
GPIO_24	GPIO_25	GPIO_26
CARD	GPIO_27	GPIO_28
GPIO_29	GPIO_30	GPIO_31

DC Power
Isolated Design
24V ± 20%

DIN-rail Clip



Recovery USB Drive



COM 1-3
Isolated design
All support up to 187.5 Kbps

SD Card

SW1	SW2	SW3	SW4	Main Function
ON	ON	ON	ON	Normal Operation
ON	ON	ON	OFF	Bypass Self-Test
ON	ON	OFF	OF	Reserved
ON	ON	OFF	OFF	System Menu
ON	OFF	X	X	Reserved
OFF	ON	X	X	COM Port Test
OFF	OFF	OFF	OFF	Bench Test
OFF	OFF	OFF	ON	Individual Function Test
OFF	OFF	ON	X	Reserved

Ethernet 1 & 2 (option) USB (device)

*1 connector split to 2 types of serial connections

COM
RS-232
RS-422/485

LAN1
10/100 Mbit Ethernet Port

LAN2
10/100 Mbit Ethernet Port

Embedded Box PC

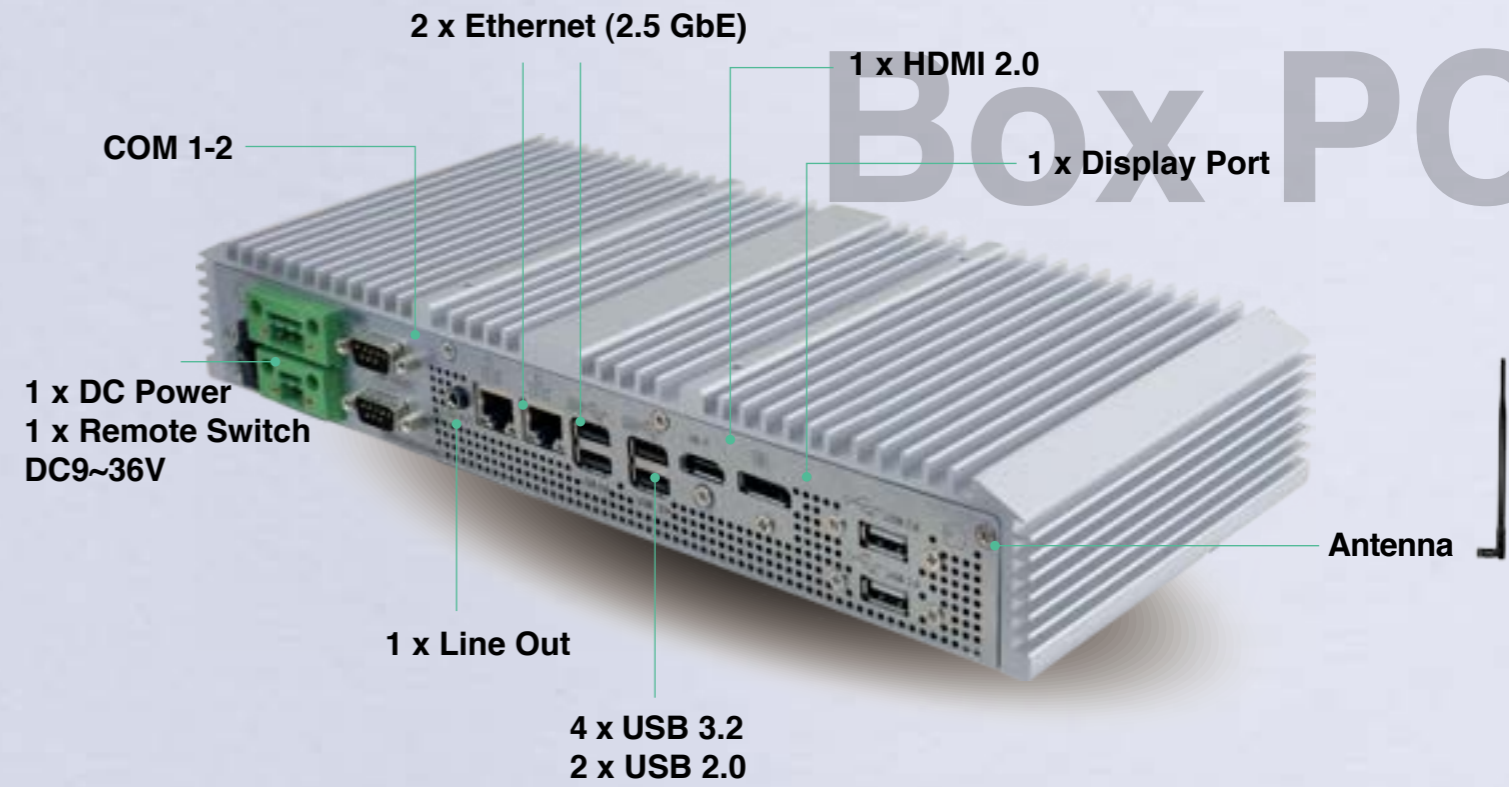

Panel PC

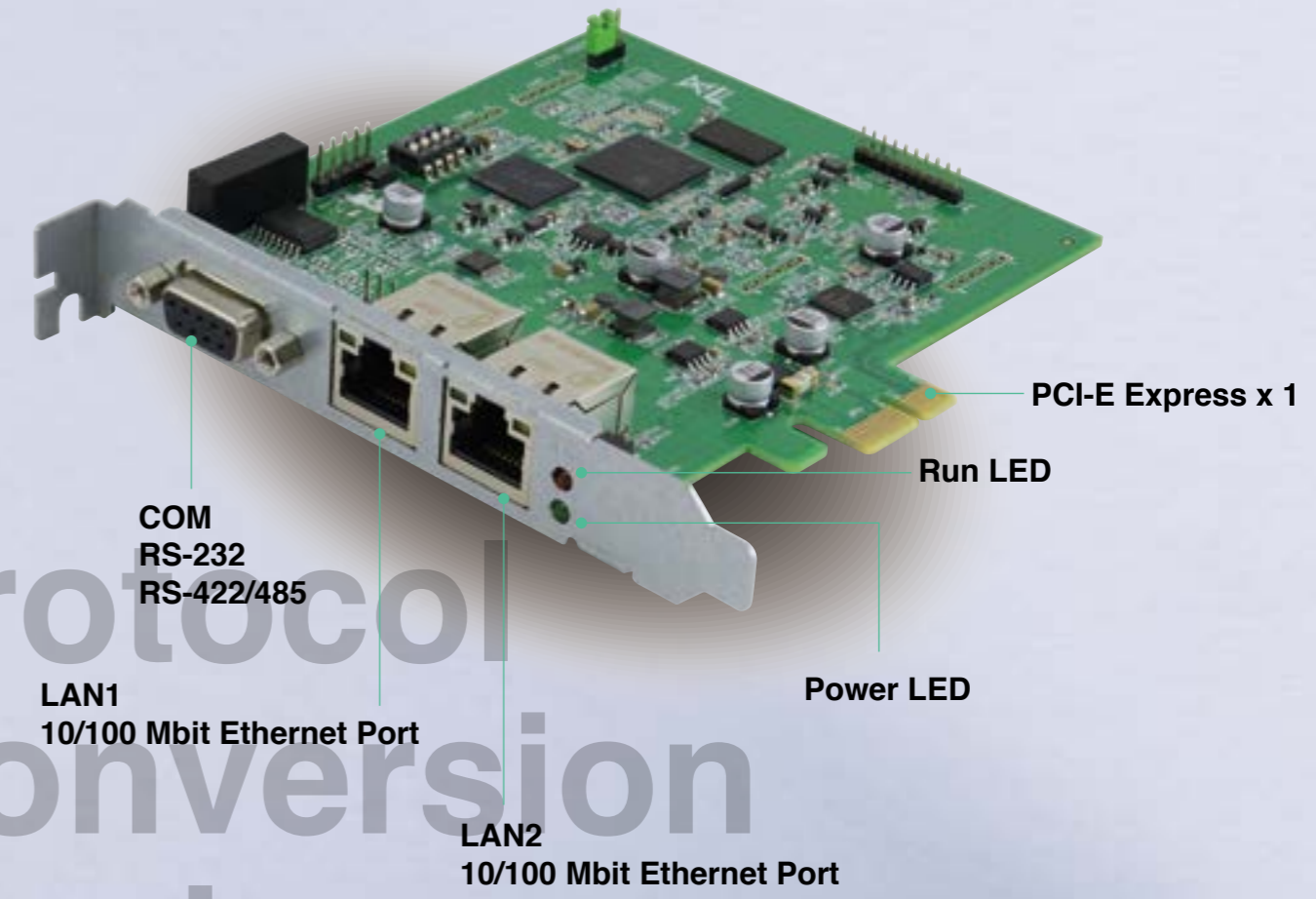
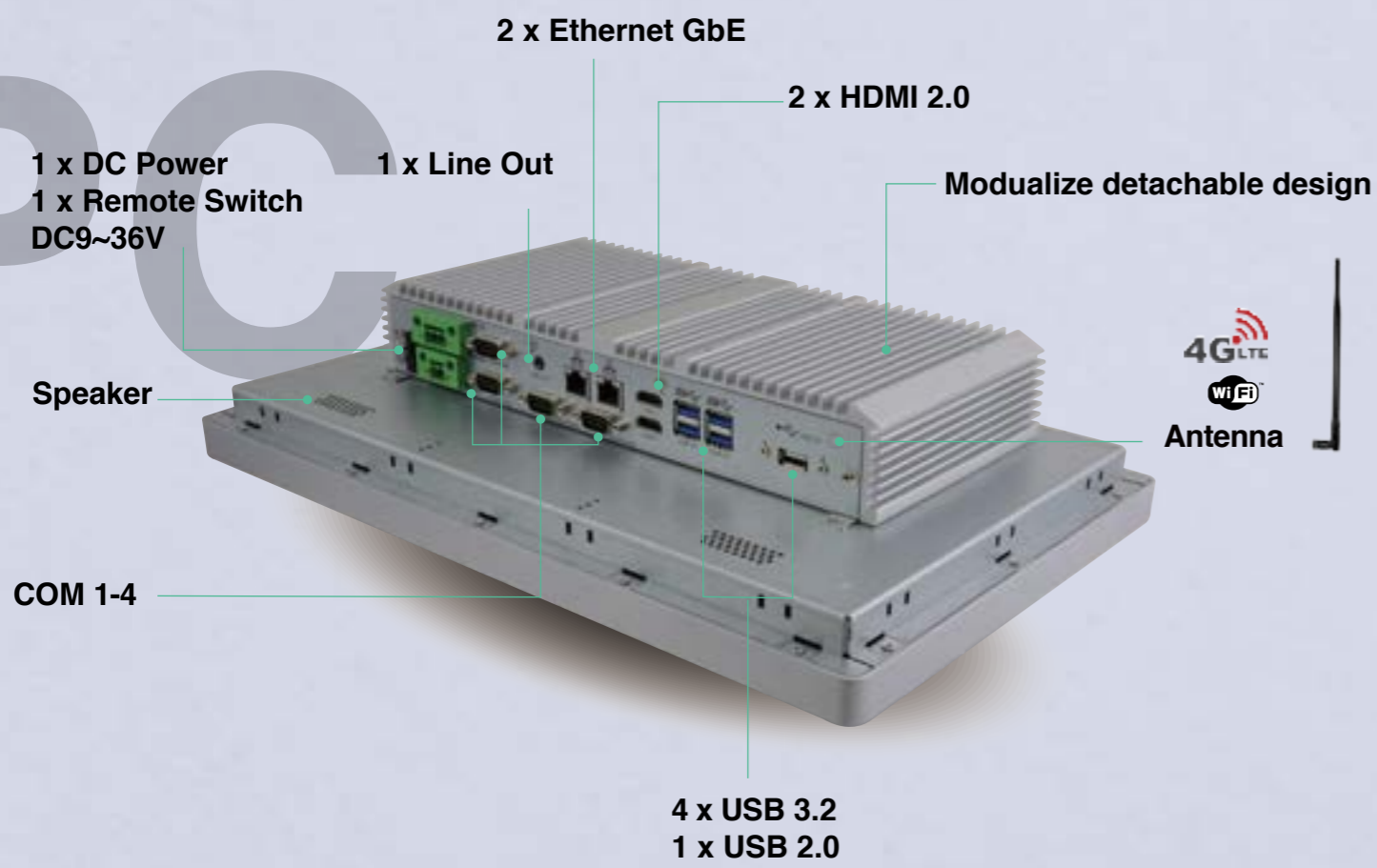

Protocol Conversion Card

Industrial HMI Operator Panel NK03

HMI
N SERIES



Features

- ARM 9 (400 MHz)
- 3.5" TFT 320 x 240, 300 cd/m², 20,000 hours
- Come with function and numeric keys
- 19.2 ~ 28.8V, Isolated Power
- Plastic chassis, fan-less design
- Panel mount, IP65 front bezel
- Suitable for industrial applications

Specifications

CPU	ARM 9 (400 MHz)
Memory	128MB SDRAM
Storage	128MB NAND Flash
I/O	1 x USB 1.1 host Type A 1 x USB 2.0 device Type B 1 x RS232 1 x RS422/485, COM1 Function keys (F1 ~ F11) Numeric Keys (0~9 , A~F)
Display	3.5" TFT, 320 x 240 Luminance 300 (cd/m ²) View angle 140/130 (H°/V°) Backlight Lifetime 20,000 hours Contrast ratio 500:1
Touch Screen	-
Power	19.2 ~ 28.8V Isolated Power
Construction	Plastic
Net Weight(Kgs)	0.33 Kg
Mounting	Panel mount
Dimensions (mm)	178(W) x 107.3(H) x 49.5(D)
Operating Temp.	0°C ~ 50°C
Storage Temp.	-20°C ~ 60°C
Humidity	10% to 90% @ 40°C, (non-condensing)
Certification	CE/FCC (EN 61000-6-4, EN 61000-6-2)

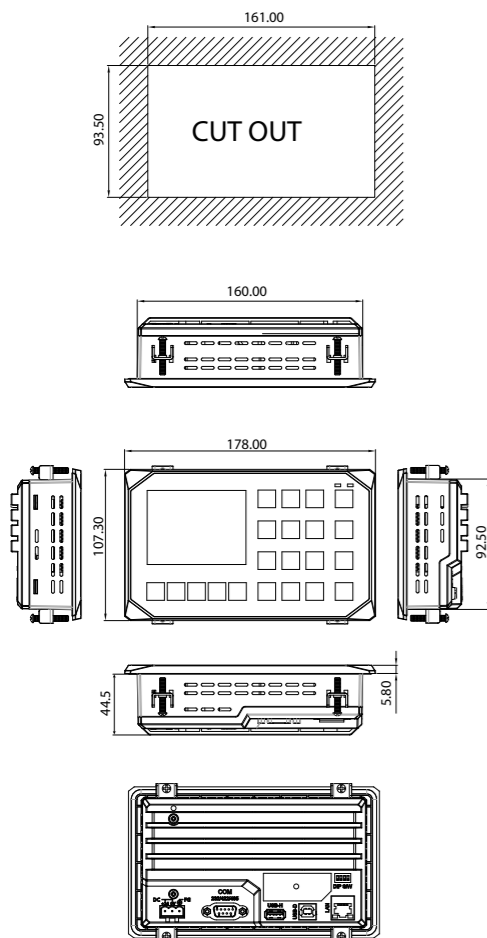

Ordering Information

NK03-P

3.5" TFT 320 x 240 fan-less keypad HMI with ARM 9 (400 MHz) CPU, 128MB RAM, 128M Flash, 19.2 ~ 28.8V isolated power, painted plastic chassis and IP65 front bezel

Industrial HMI Operator Panel N04

HMI
N SERIES



Features

- ARM 9 (400 MHz)
- 4.3" TFT 480 x 272, 500 cd/m², 20,000 hours
- 19.2 ~ 28.8V, Isolated Power
- Plastic chassis, fan-less design
- Panel mount, IP65 front bezel
- Suitable for industrial applications

Specifications

CPU	ARM 9 (400 MHz)
Memory	128MB SDRAM
Storage	128MB NAND Flash
I/O	1 x USB 1.1 host Type A 1 x USB 2.0 device Type B 1 x RS232 1 x RS422/485, COM1 1 x 10/100 Mbit Ethernet Port
Display	4.3" TFT, 480 x 272 Luminance 500 (cd/m ²) View angle 140/120 (H°/V°) Backlight Lifetime 20,000 hours Contrast ratio 500:1
Touch Screen	4-wire resistive touch
Power	19.2 ~ 28.8V Isolated Power
Construction	Plastic IP65 front bezel
Net Weight(Kgs)	0.25 Kg
Mounting	Panel mount
Dimensions (mm)	127.7(W) x 89.7(H) x 36.7(D)
Operating Temp.	0°C ~ 45°C
Storage Temp.	-20°C ~ 60°C
Humidity	10% to 90% @ 40°C, (non-condensing)
Certification	CE/FCC (EN 61000-6-4, EN 61000-6-2)/UL

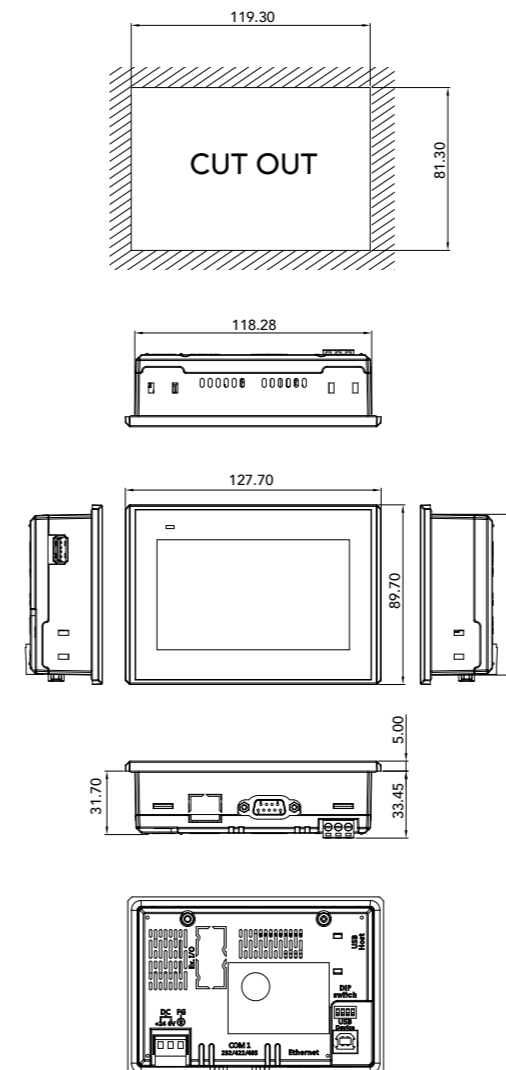

Ordering Information

N04F-N

4.3" TFT 480 x 272 fan-less HMI with ARM 9 (400 MHz) CPU, 128MB RAM, 128M Flash, resistive touch screen, Ethernet, 19.2 ~ 28.8V isolated power, plastic chassis and IP65 front bezel

Industrial HMI Operator Panel N07

HMI
N SERIES

Industrial HMI Operator Panel P04

HMI
P SERIES



Features

- ARM 9 (400 MHz)
- 7" TFT 800 x 480, 250 cd/m², 20,000 hours
- 19.2 ~ 28.8V, Isolated Power
- Painted plastic chassis, fan-less design
- Panel or VESA 75mm x 75 mm mount, IP65 front bezel
- ESD Protection : Level 4 (Contact Discharge 8KV, Air-Gap Discharge 15KV), Class A
- Suitable for industrial applications

Specifications

CPU	ARM 9 (400 MHz)
Memory	128MB SDRAM
Storage	128MB NAND Flash
I/O	1 x USB 1.1 host Type A 1 x USB 2.0 device Type B 2 x RS232/422/485, COM1, COM2 1 x RS232/485, COM3 1 x 10/100 Mbit Ethernet Port 1 x SD Card Slot
Display	7" TFT, 800 x 480 Luminance 250 (cd/m ²) View angle 140/120 (H°/V°) Backlight Lifetime 20,000 hours Contrast ratio 500:1
Touch Screen	4-wire resistive touch
Power	19.2 ~ 28.8V Isolated Power
Construction	Painted Plastic IP65 front bezel
Net Weight(Kgs)	0.68 Kg
Mounting	Panel or VESA 75 x 75 mount
Dimensions (mm)	199.8(W) x 147.8(H) x 39.8(D)
Operating Temp.	0°C ~ 50°C
Storage Temp.	-20°C ~ 60°C
Humidity	10% to 90% @ 40°C, (non-condensing)
ESD Protection	Level 4 (Contact Discharge 8KV, Air-Gap Discharge 15KV), Class A
Certification	CE/FCC (EN 61000-6-4, EN 61000-6-2)/UL

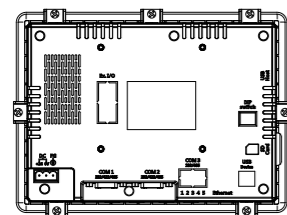
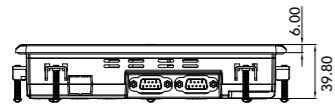
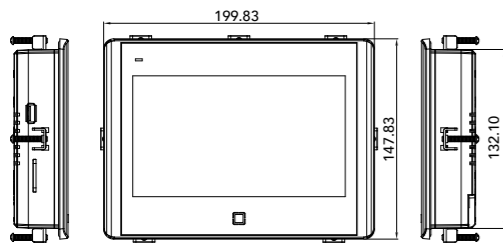
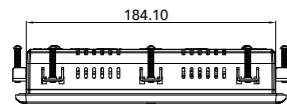
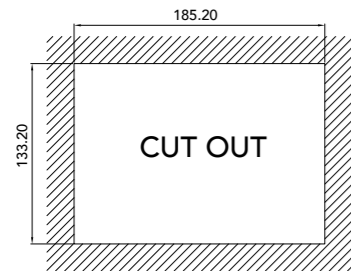

Ordering Information

N07F-N

7" TFT 800 x 480 fan-less HMI with ARM9 (400 MHz) CPU, 128MB RAM, 128M Flash, resistive touch screen, Ethernet, 19.2 ~ 28.8V isolated power, painted plastic chassis and IP65 front bezel



Features

- TI ARM[®] Cortex™-A8, Sitara™ AM3352 (1GHz)
- 4.3" TFT 480 x 272, 500 cd/m², 20,000 hours
- 19.2 ~ 28.8V, Isolated Power
- Plastic chassis, fan-less design
- Panel mount, IP65 front bezel
- Suitable for industrial applications

Specifications

CPU	TI ARM [®] Cortex™-A8, Sitara™ AM3352 (1GHz)
Memory	512MB
Storage	4GB eMMC
I/O	1 x USB 1.1 host Type A 1 x USB 2.0 device Type B 1 x RS232 1 x RS422/485, COM1 or CAN Bus (Option) 1 x 10/100 Mbit Ethernet Port
Display	4.3" TFT, 480 x 272 Luminance 500 (cd/m ²) View angle 140/120 (H°/V°) Backlight Lifetime 20,000 hours Contrast ratio 500:1
Touch Screen	4-wire resistive touch
Power	19.2 ~ 28.8V Isolated Power
Construction	Plastic
Net Weight(Kgs)	0.25 Kg
Mounting	Panel mount
Dimensions (mm)	127.7(W) x 89.7(H) x 36.7(D) mm
Operating Temp.	0°C ~ 45°C
Storage Temp.	-20°C ~ 60°C
Humidity	10% to 90% @ 40°C, (non-condensing)
Certification	CE/FCC (EN 61000-6-4, EN 61000-6-2)

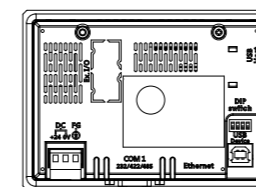
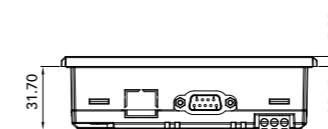
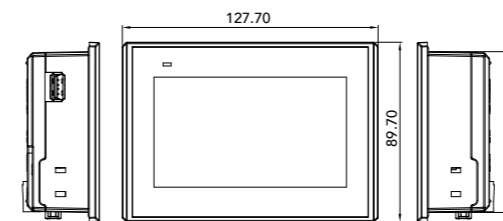
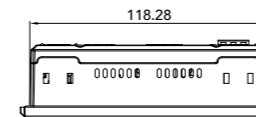
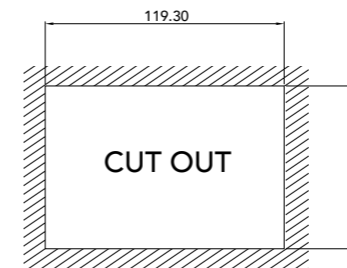
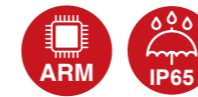

Ordering Information

P04F-N

4.3" TFT 480 x 272 fan-less HMI with ARM Cortex-A8(1GHz) CPU, 512MB RAM, 4GB eMMC, resistive touch screen, Ethernet, 19.2 ~ 28.8V isolated power, plastic chassis and IP65 front bezel

Industrial HMI Operator Panel P07

HMI
P SERIES



Features

- TI ARM® Cortex™-A8, Sitara™ AM3352 (1GHz)
- 7" TFT 800 x 480, 250 cd/m², 20,000 hours
- 19.2 ~ 28.8V, Isolated Power
- Painted plastic chassis, fan-less design
- Panel or VESA 75mm x 75 mm mount, IP65 front bezel
- ESD Protection : Level 4 (Contact Discharge 8KV, Air-Gap Discharge 15KV), Class A
- Suitable for industrial applications

Specifications

CPU	TI ARM® Cortex™-A8, Sitara™ AM3352 (1GHz)
Memory	512MB SDRAM
Storage	4GB eMMC
I/O	1 x USB 1.1 host Type A 1 x USB 2.0 device Type B 2 x RS232/422/485, COM1, COM2 1 x RS232/485, COM3 or CAN Bus (Option) 1 x 10/100 Mbit Ethernet Port or 2 x 10/100 Mbit (Option) 1 x SD Card Slot
Display	7" TFT, 800 x 480 Luminance 250 (cd/m ²) View angle 140/120 (H°/V°) Backlight Lifetime 20,000 hours Contrast ratio 500:1
Touch Screen	4-wire resistive touch
Power	19.2 ~ 28.8V Isolated Power
Construction	Painted Plastic
Net Weight(Kgs)	0.68 Kg
Mounting	Panel or VESA 75 x 75 mount
Dimensions (mm)	199.8(W) x 147.8(H) x 39.8(D)
Operating Temp.	0°C ~ 50°C
Storage Temp.	-20°C ~ 60°C
Humidity	10% to 90% @ 40°C, (non-condensing)
ESD Protection	Level 4 (Contact Discharge 8KV, Air-Gap Discharge 15KV), Class A
Certification	CE/FCC (EN 61000-6-4, EN 61000-6-2)/UL

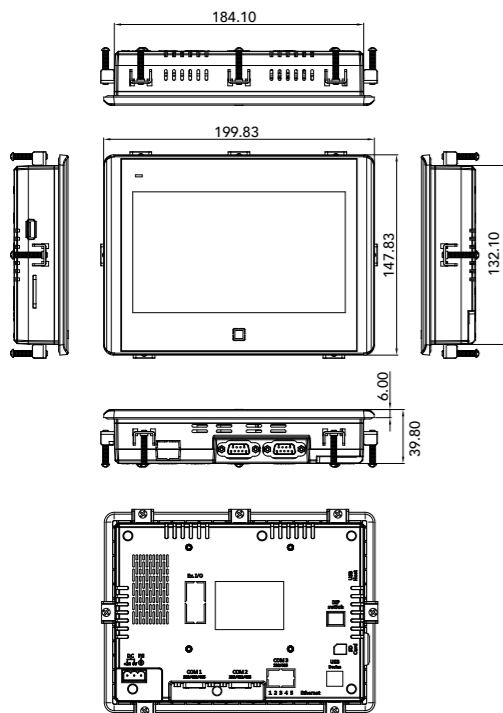
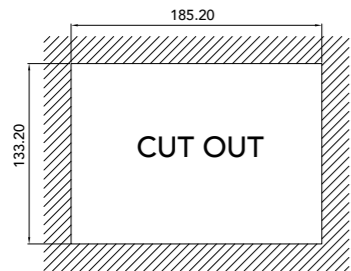

Ordering Information

P07F-N

7" TFT 800 x 480 fan-less HMI with ARM Cortex-A8(1GHz) CPU, 512MB RAM, 4GB eMMC, resistive touchscreen, Ethernet, 19.2 ~ 28.8V isolated power, painted plastic chassis and IP65 front bezel

Industrial HMI Operator Panel P10

HMI
P SERIES



Features

- TI ARM® Cortex™-A8, Sitara™ AM3352 (1GHz)
- 10.2" TFT 800 x 480, 350 cd/m², 20,000 hours
- 19.2 ~ 28.8V, Isolated Power
- Painted plastic chassis, fan-less design
- Panel or VESA 75mm x 75 mm mount, IP65 front bezel
- ESD Protection : Level 4 (Contact Discharge 8KV, Air-Gap Discharge 15KV), Class A
- Suitable for industrial applications

Specifications

CPU	TI ARM® Cortex™-A8, Sitara™ AM3352 (1GHz)
Memory	512MB SDRAM
Storage	4GB eMMC
I/O	1 x USB 2.0 host Type A 1 x USB 2.0 device Type B 2 x RS232/422/485, COM1, COM2 1 x RS232/485, COM3 or CAN Bus (Option) 1 x 10/100 Mbit Ethernet Port or 2 x 10/100 Mbit (Option) 1 x SD Card Slot
Display	10.2" TFT, 800 x 480 Luminance 350 (cd/m ²) View angle 130/110 (H°/V°) Backlight Lifetime 20,000 hours Contrast ratio 300:1
Touch Screen	4-wire resistive touch
Power	19.2 ~ 28.8V Isolated Power
Construction	Painted Plastic
Net Weight(Kgs)	1.1 Kg
Mounting	Panel or VESA 75 x 75 mount
Dimensions (mm)	279.5(W) x 195.5(H) x 39.5(D)
Operating Temp.	0°C ~ 50°C
Storage Temp.	-20°C ~ 60°C
Humidity	10% to 90% @ 40°C, (non-condensing)
ESD Protection	Level 4 (Contact Discharge 8KV, Air-Gap Discharge 15KV), Class A
Certification	CE/FCC (EN 61000-6-4, EN 61000-6-2)/UL

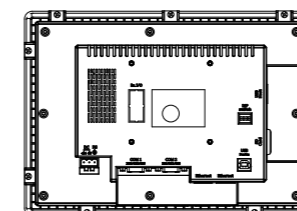
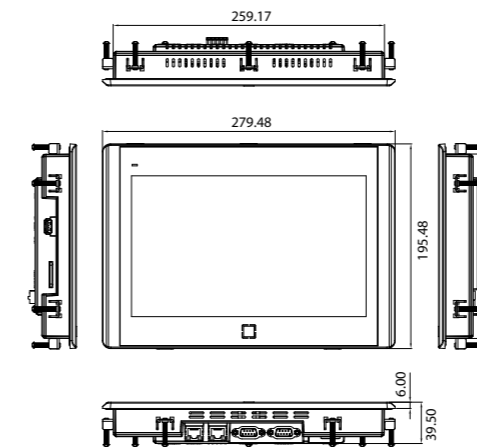
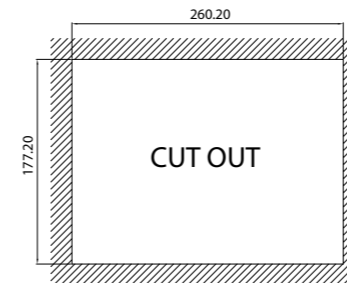

Ordering Information

P10F-N

10.2" TFT 800 x 480 fan-less HMI with ARM Cortex-A8 (1GHz) CPU, 512MB RAM, 4GB eMMC, resistive touch screen, Ethernet, 19.2 ~ 28.8V isolated power, painted plastic chassis and IP65 front bezel

Industrial HMI Operator Panel P12

HMI
P SERIES



Features

- TI ARM® Cortex™-A8, Sitara™ AM3352 (1GHz)
- 12.1" TFT 1280 x 800, 600 cd/m², 50,000 hours
- 19.2 ~ 28.8V, Isolated Power
- Aluminum IP65 front bezel and steel chassis
- Panel or VESA 100 mm x 100 mm mount
- ESD Protection : Level 4 (Contact Discharge 8KV, Air-Gap Discharge 15KV), Class A
- Suitable for industrial applications

Specifications

CPU	TI ARM® Cortex™-A8, Sitara™ AM3352 (1GHz)
Memory	512MB SDRAM
Storage	4GB eMMC
I/O	1 x USB 2.0 host Type A 1 x USB 2.0 device Type B 2 x RS232/422/485, COM1, COM2 1 x RS232/485, COM3 or CAN Bus (Option) 1 x 10/100 Mbit Ethernet Port or 2 x 10/100 Mbit (Option) 1 x SD Card Slot
Display	12.1" TFT, 1280 x 800 Luminance 450 (cd/m ²) View angle 176/176 (H°/V°) Backlight Lifetime 50,000 hours Contrast ratio 1000:1
Touch Screen	5-wire resistive touch
Power	19.2 ~ 28.8V Isolated Power
Construction	Aluminum IP65 front bezel and steel chassis
Net Weight(Kgs)	4.3 Kg
Mounting	Panel or VESA 100 x 100 mount
Dimensions (mm)	319.0(W) x 225.0(H) x 50.6(D)
Operating Temp.	0°C ~ 50°C
Storage Temp.	-20°C ~ 60°C
Humidity	10% to 90% @ 40°C, (non-condensing)
ESD Protection	Level 4 (Contact Discharge 8KV, Air-Gap Discharge 15KV), Class A
Certification	CE/FCC (EN 61000-6-4, EN 61000-6-2)

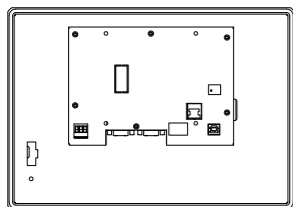
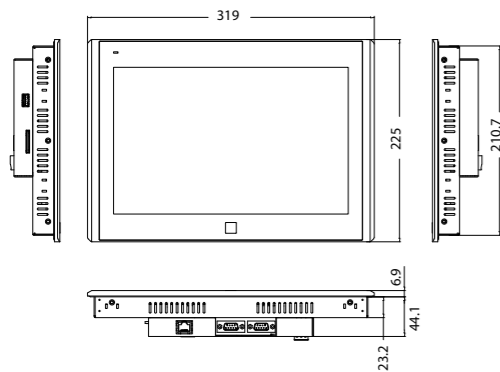
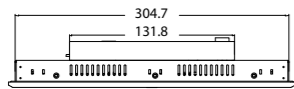
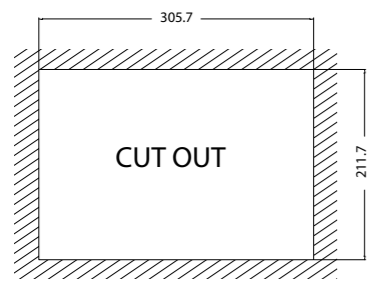

Ordering Information

P12F-N

12.1" TFT 1280 x 800 fan-less HMI with ARM Cortex-A8 (1GHz) CPU, 512MB RAM, 4GB eMMC, resistive touch screen, Ethernet, 19.2 ~ 28.8V isolated power, aluminum front bezel, steel rear chassis

Industrial HMI Operator Panel P15

HMI
P SERIES



Features

- TI ARM® Cortex™-A8, Sitara™ AM3352 (1GHz)
- 15.6" TFT 1366 x 768, 500 cd/m², 50,000 hours
- 19.2 ~ 28.8V, Isolated Power
- Aluminum IP65 front bezel and steel chassis
- Panel or VESA 100 mm x 100 mm mount
- ESD Protection : Level 4 (Contact Discharge 8KV, Air-Gap Discharge 15KV), Class A
- Suitable for industrial applications

Specifications

CPU	TI ARM® Cortex™-A8, Sitara™ AM3352 (1GHz)
Memory	512MB SDRAM
Storage	4GB eMMC
I/O	1 x USB 2.0 host Type A 1 x USB 2.0 device Type B 2 x RS232/422/485, COM1, COM2 1 x RS232/485, COM3 or CAN Bus (Option) 1 x 10/100 Mbit Ethernet Port or 2 x 10/100 Mbit (Option) 1 x SD Card Slot
Display	15.6" TFT, 1366 x 768 Luminance 500 (cd/m ²) View angle 160/150 (H°/V°) Backlight Lifetime 50,000 hours Contrast ratio 600:1
Touch Screen	5-wire resistive touch
Power	19.2 ~ 28.8V Isolated Power
Construction	Aluminum IP65 front bezel and steel chassis
Net Weight(Kgs)	5.8 Kg
Mounting	Panel or VESA 100 x 100 mount
Dimensions (mm)	408.8(W) x 260.9(H) x 50.6(D)
Operating Temp.	0°C ~ 50°C
Storage Temp.	-20°C ~ 60°C
Humidity	10% to 90% @ 40°C, (non-condensing)
ESD Protection	Level 4 (Contact Discharge 8KV, Air-Gap Discharge 15KV), Class A
Certification	CE/FCC (EN 61000-6-4, EN 61000-6-2)

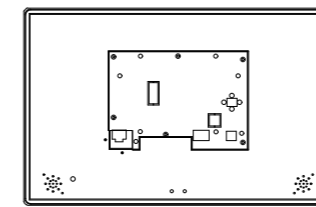
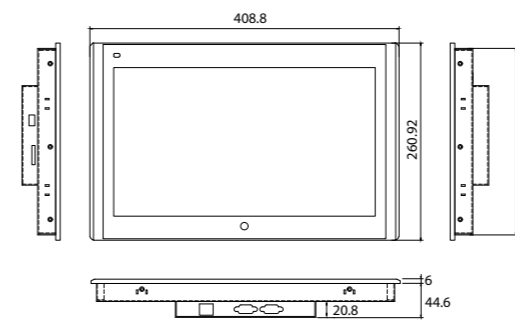
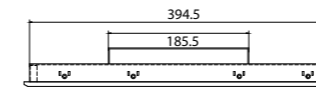
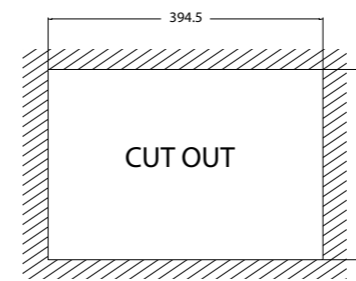

Ordering Information

P15F-N

15.6" TFT 1366 x 768 fan-less HMI with ARM Cortex-A8 (1GHz) CPU, 512MB RAM, 4GB eMMC, resistive touch screen, Ethernet, 19.2 ~ 28.8V isolated power, aluminum front bezel, steel rear chassis

Selection Guide

HMI
SERIES

N-SERIES				
Model		NK03	N04	N07
		NK03-P	N04F-N	N07F-N
Display	Display type	3.5" TFT	4.3" TFT	7" TFT
	Resolution	320 X 240	480 x 272	800 x 480
	Color depth	64K		
	Backlight type	LED		
	Luminance (cd/m ²)	300	500	250
	Backlight lifetime	20,000 hours		
	Viewing angle (H°/V°)	140/130	140/120	140/120
	Contrast	500:1		
	Dimming	20 levels		
System	CPU	ARM9 (400 MHz)		
	Storage	128MB NAND Flash		
	Memory	128MB		
	RTC	Yes		
Interface	Touch Screen	-	4-wire resistive type	
	COM1	1 x RS232, 1 x RS422/485		RS232/422/485
	COM2	-		RS232/422/485
	COM3	-		RS232/485
	Ethernet	1 x 10/100Mbit		
	USB	1 x Type A (Host), 1 x Type B (Device)		
	Memory card	-		SD Card
Ratings	Power supply voltage	19.2 ~ 28.8V, Isolated Power		
	Power consumption	6W		8W
	Weight (kg)	0.33	0.25	0.68
	Battery	CR2032 Replaceable		
Environment	Operation temperature	0 ~ 50°C	0 ~ 45°C	0 ~ 50°C
	Storage temperature	-20 ~ 60°C		
	Humidity	10% ~ 90% (non-condensing)@40°C		
Mechanical	Construction	Plastic		
	Protection	IP65 (Front)		
	Mounting (mm)	Panel Mount		Panel Mount, VESA 75 x 75
	Dimension (mm)	178(W) x 107.3(H) x 49.5(D)	127.7(W) x 89.7(H) x 36.7(D)	199.8(W) x 147.8(H) x 39.8(D)
	Cut-out (mm)	161(W) x 93.5(H)	119.3(W) x 81.3(H)	185.2(W) x 133.2(H)
Approvals	ESD Protection	-		Level 4 (Contact Discharge 8KV, Air-Gap 15KV), Class A
	Certification	CE/FCC (EN 61000-6-4, EN 61000-6-2)	CE / FCC (EN 61000-6-4, EN 61000-6-2) / UL	CE / FCC (EN 61000-6-4, EN 61000-6-2) / UL
Software	iFace Designer®			

Selection Guide

HMI
SERIES

P-SERIES						
Model		P04	P07	P10	P12	P15
		P04F-N	P07F-N	P10F-N	P12F-N	P15F-N
Display	Display type	4.3" TFT	7" TFT	10.2" TFT	12.1" TFT	15.6" TFT
	Resolution	480 x 272	800 x 480		1280 x 800	1366 x 768
	Color depth	16.7M				
	Backlight type	LED				
	Luminance (cd/m ²)	500	250	350	600	500
	Backlight lifetime	20,000 hours			50,000 hours	
	Viewing angle (H°/V°)	140/120		130/110	176/176	160/150
	Contrast	500:1		300:1	1000:1	600:1
	Dimming	20 levels				
	System	CPU	TI ARM® Cortex™-A8, Sitara™ AM3352 (1GHz)			
Storage		4GB eMMC				
Memory		512MB				
RTC		Yes				
Interface	Touch Screen	4-wire resistive type			5-wire resistive type	
	COM1	1 x RS232, 1 x RS422/485 or CAN bus (option)	RS232/422/485			
	COM2	-		RS232/422/485		
	COM3	-		RS232/485 or CAN bus (option)		
	Ethernet	1 x 10/100 Mbit	1 x 10/100 Mbit or 2 x 10/100 Mbit (option)			
	USB	1 x Type A (Host), 1 x Type B (Device)				
	Memory card	-		SD Card		
	Ratings	Power supply voltage	19.2 ~ 28.8V Isolated Power			
Power consumption		6W	8W	10W	22W	28W
Weight (kg)		0.25	0.68	1.1	4.3	5.8
Battery		CR2032 Replaceable				
Environment	Operation temperature	0 ~ 45°C	0 ~ 50°C			
	Storage temperature	-20 ~ 60°C				
	Humidity	10% ~ 90% (non-condensing) @ 40°C				
Mechanical	Construction	Plastic			Aluminum front bezel and steel chassis	
	Protection	IP65(Front)				
	Mounting (mm)	Panel Mount	Panel Mount, VESA 75 x 75	Panel Mount, VESA 100 x 100		
	Dimension (mm)	127.7(W) x 89.7(H) x 36.7(D)	199.8(W) x 147.8(H) x 39.8(D)	279.5(W) x 195.5(H) x 39.5(D)	319.0(W) x 225.0(H) x 50.6(D)	408.8(W) x 260.9(H) x 50.6(D)
	Cut-out (mm)	119.3(W) x 81.3(H)	185.2(W) x 133.2(H)	260.2(W) x 177.2(H)	305.7(W) x 211.7(H)	394.5(W) x 246.62(H)
Approvals	ESD Protection	-		Level 4 (Contact Discharge 8KV, Air-Gap Discharge 15KV), Class A		
	Certification	CE/FCC (EN 61000-6-4, EN 61000-6-2)	CE / FCC (EN 61000-6-4, EN 61000-6-2) / UL		CE/FCC (EN 61000-6-4, EN 61000-6-2)	
Software	iFace Designer®					



P01



P02 / P03

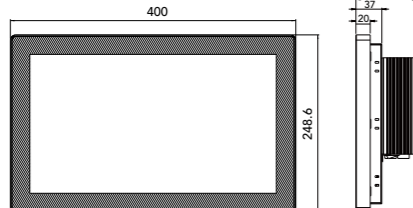
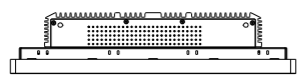
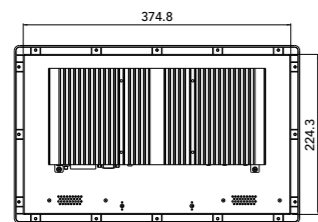
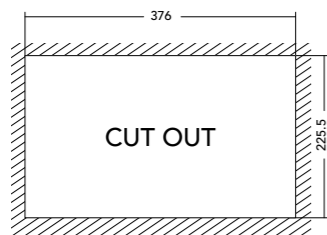

Features

Intel® Celeron® J6412 Processor Fanless Industrial Modular Panel PC

Powered by
Siemens
Industrial Edge

A Siemens Certified Edge Device

- Intel® Celeron® Processor J6412 (Elkhart Lake) 2.0 GHz (up to 2.6 GHz)
- 15.6" Full HD 1920x1080, TFT-LCD
- Resistive Touch / Projected Capacitive Touch
- IP66-rated aluminum front bezel and steel chassis
- GbE Ethernet ports x 2
- COM port x 4 (RS-232 x 2, RS-232/422/485 x 2)
- USB x 5 (3.2 Gen1 x 4, 2.0 x 1)
- DC 9~36V wide range power input
- Fan-less, modular detachable design
- VESA mounting 100x100mm / Panel mounting

Intel® Processor N-series N97 Fanless Industrial Modular Panel PC

- Intel® Alder Lake-N Processor N97 2.0 GHz (up to 3.6 GHz)
- 15.6" Full HD 1920x1080, TFT-LCD
- Resistive Touch / Projected Capacitive Touch
- IP66-rated aluminum front bezel and steel chassis
- 2.5 GbE Ethernet ports x 2
- COM port x 2 (RS-232 x 1, RS-232/422/485 x 1)
- USB x 6 (3.2 Gen1 x 2, 3.2 Gen2 x 2, 2.0 x 2)
- DC 9~36V wide range power input
- Fan-less, modular detachable design
- VESA mounting 100x100mm / Panel mounting

Intel® Core™ i3-N305 Processor Fanless Industrial Modular Panel PC

- Intel® Alder Lake-N Core i3-N305 1.8 GHz (up to 3.8 GHz)
- 15.6" Full HD 1920x1080, TFT-LCD
- Resistive Touch / Projected Capacitive Touch
- IP66-rated aluminum front bezel and steel chassis
- 2.5 GbE Ethernet ports x 2
- COM port x 2 (RS-232 x 1, RS-232/422/485 x 1)
- USB x 6 (3.2 Gen1 x 2, 3.2 Gen2 x 2, 2.0 x 2)
- DC 9~36V wide range power input
- Fan-less, modular detachable design
- VESA mounting 100x100mm / Panel mounting

Specifications

Model No.	NPP-156P01	NPP-156P02	NPP-156P03	
System	CPU	Intel® Celeron® J6412 2.0GHz, quad-core, 4 threads, (up to 2.6GHz)	Intel® Alder Lake-N Processor N97 2.0GHz, quad-core, 4 threads, (up to 3.6GHz)	
	System Chipset	SoC		
	System Memory	1 x SO-DIMM, DDR4 3200MHz, up to 32GB	1 x SO-DIMM, DDR5 4800MHz, up to 16GB	
Storage	SSD	1 x 2280 M.2 M-key (PCIe x2, SATA 6Gb/s)	1 x 2280 M.2 B key (SATA/PCIe x1)	
Expansion	Expansion Slot	1 x Full-size mini PCIe	1 x M.2 E key (PCIe x1, USB 2.0), 2230	
Display & Touch Screen	LCD Size	15.6" TFT-LCD		
	Luminance (cd/m²)	350 (Typ.)		
	Backlight Lifetime (hrs)	50000		
	Contrast	800:1		
	Max. Colors	16.7M		
	Max. Resolution	1920x1080		
	Viewangle (H°/V°)	178 / 178		
	Touch Type	Projected Capacitive Touch		
	Touch Interface	USB		
I/O Interface	Light Transmission (%)	Over 84%		
	Audio	1 x Line Out	1 x Line Out	
	HDMI 2.0	2	1	
	Display Port	-	1	
	LAN (RJ45)	2 x GbE	2 x 2.5GbE	
	Power	1 x 2 pins terminal block for external power switch 1 x 3 pins terminal block power connector 1 x power switch on/off	1 x 2 pins terminal block for external power switch 1 x 3 pins terminal block power connector 1 x power switch on/off	
	Serial	1 x DB9 (RS-232/422/485 & RI/5V/12V) 1 x DB9 (RS-232/422/485) 2 x DB9 (RS-232)	1 x DB9 (RS-232/422/485 & RI/5V/12V) 1 x DB9 (RS-232)	
	USB	4 x USB 3.2 Gen 1, 1 x USB 2.0	2 x USB 3.2 Gen 1, 2 x USB 3.2 Gen 2, 2 x USB 2.0	
	Power	Power Input	DC 9~36V	
		Power Consumption	90W	
Environment	Operating Temp.	0~50° C (32~122° F)		
	Operating Humidity	10 to 90% (non-condensing)		
	Storage Temp.	-20~60° C (-4~140° F)		
	Operating System	Windows 10 IoT, Debian 11		
Mechanical	Certification	CE/FCC		
	Construction	Aluminum front bezel and steel chassis		
	IP Rating	Front Panel IP66		
	Mounting	Panel Mount / VESA Mount		
	Dimension(mm)	400 x 248.6 x 86		
Net Weight(Kgs)	5.5			

Ordering Information

NPP156P01	15.6" Full HD Fanless Panel PC with Intel Celeron J6412 2.0 GHz, 8GB DDR4 3200MHz, Projected Capacitive Touch, 9~36V DC input with adapter, Aluminum chassis
NPP156P02	15.6" Full HD Fanless Panel PC withW Intel Alder Lake-N Processor N97 2.0 GHz, 8GB DDR4 3200MHz, Projected Capacitive Touch, 9~36V DC input with adapter, Aluminum chassis
NPP156P03	15.6" Full HD Fanless Panel PC with Intel Alder Lake-N Core i3-N305 1.8GHz, 8GB DDR4 3200MHz, Projected Capacitive Touch, 9~36V DC input with adapter, Aluminum chassis



P01



P02 / P03

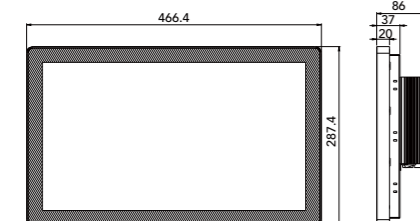
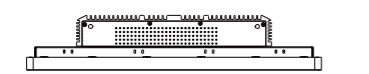
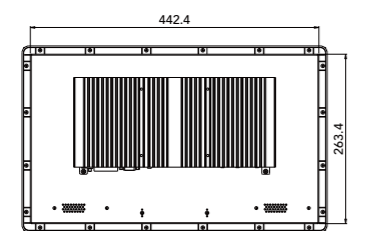
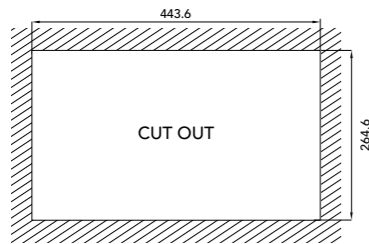

Features

Intel® Celeron® J6412 Processor Fanless Industrial Modular Panel PC



A Siemens Certified Edge Device

- Intel® Celeron® Processor J6412 (Elkhart Lake) 2.0 GHz (up to 2.6 GHz)
- 18.5" Full HD 1920x1080, TFT-LCD
- Resistive Touch / Projected Capacitive Touch
- IP66-rated aluminum front bezel and steel chassis
- GbE Ethernet ports x 2
- COM port x 4 (RS-232 x 2, RS-232/422/485 x 2)
- USB x 5 (3.2 Gen1 x 4, 2.0 x 1)
- DC 9~36V wide range power input
- Fan-less, modular detachable design
- VESA mounting 100x100mm / Panel mounting

Intel® Processor N-series N97 Fanless Industrial Modular Panel PC

- Intel® Alder Lake-N Processor N97 2.0 GHz (up to 3.6 GHz)
- 18.5" Full HD 1920x1080, TFT-LCD
- Resistive Touch / Projected Capacitive Touch
- IP66-rated aluminum front bezel and steel chassis
- 2.5 GbE Ethernet ports x 2
- COM port x 2 (RS-232 x 1, RS-232/422/485 x 1)
- USB x 6 (3.2 Gen1 x 2, 3.2 Gen2 x 2, 2.0 x 2)
- DC 9~36V wide range power input
- Fan-less, modular detachable design
- VESA mounting 100x100mm / Panel mounting

Intel® Core™ i3-N305 Processor Fanless Industrial Modular Panel PC

- Intel® Alder Lake-N Core i3-N305 1.8 GHz (up to 3.8 GHz)
- 18.5" Full HD 1920x1080, TFT-LCD
- Resistive Touch / Projected Capacitive Touch
- IP66-rated aluminum front bezel and steel chassis
- 2.5 GbE Ethernet ports x 2
- COM port x 2 (RS-232 x 1, RS-232/422/485 x 1)
- USB x 6 (3.2 Gen1 x 2, 3.2 Gen2 x 2, 2.0 x 2)
- DC 9~36V wide range power input
- Fan-less, modular detachable design
- VESA mounting 100x100mm / Panel mounting

Specifications

Model No.	NPP-185P01	NPP-185P02	NPP-185P03	
System	CPU	Intel® Celeron® J6412 2.0GHz, quad-core, 4 threads, (up to 2.6GHz)	Intel® Alder Lake-N Processor N97 2.0GHz, quad-core, 4 threads, (up to 3.6GHz)	
	System Chipset	SoC		
	System Memory	1 x SO-DIMM, DDR4 3200MHz, up to 32GB	1 x SO-DIMM, DDR5 4800MHz, up to 16GB	
Storage	SSD	1 x 2280 M.2 M-key (PCIe x2, SATA 6Gb/s)	1 x 2280 M.2 B key (SATA/PCIe x1)	
Expansion	Expansion Slot	1 x Full-size mini PCIe	1 x M.2 E key (PCIe x1, USB 2.0), 2230	
Display & Touch Screen	LCD Size	18.5" TFT-LCD		
	Luminance (cd/m²)	350 (Typ.)		
	Backlight Lifetime (hrs)	50000		
	Contrast	1000:1		
	Max. Colors	16.7M		
	Max. Resolution	1920x1080		
	Viewangle (H°/V°)	178 / 178		
	Touch Type	Projected Capacitive Touch		
	Touch Interface	USB		
I/O Interface	Light Transmission (%)	Over 84%		
	Audio	1 x Line Out	1 x Line Out	
	HDMI 2.0	2	1	
	Display Port	-	1	
	LAN (RJ45)	2 x GbE	2 x 2.5GbE	
	Power	1 x 2 pins terminal block for external power switch 1 x 3 pins terminal block power connector 1 x power switch on/off	1 x 2 pins terminal block for external power switch 1 x 3 pins terminal block power connector 1 x power switch on/off	
	Serial	1 x DB9 (RS-232/422/485 & RI/5V/12V) 1 x DB9 (RS-232/422/485) 2 x DB9 (RS-232)	1 x DB9 (RS-232/422/485 & RI/5V/12V) 1 x DB9 (RS-232)	
	USB	4 x USB 3.2 Gen 1, 1 x USB 2.0	2 x USB 3.2 Gen 1, 2 x USB 3.2 Gen 2, 2 x USB 2.0	
	Power	Power Input	DC 9~36V	
		Power Consumption	90W	
Environment	Operating Temp.	0~50° C (32~122° F)		
	Operating Humidity	10 to 90% (non-condensing)		
	Storage Temp.	-20~60° C (-4~140° F)		
	Operating System	Windows 10 IoT, Debian 11		
Mechanical	Certification	CE/FCC		
	Construction	Aluminum front bezel and steel chassis		
	IP Rating	Front Panel IP66		
	Mounting	Panel Mount / VESA Mount		
	Dimension(mm)	466.4 x 287.4 x 86		
Net Weight(Kgs)	6.5			

Ordering Information

NPP185P01	18.5" Full HD Fanless Panel PC with Intel Celeron J6412 2.0 GHz, 8GB DDR4 3200MHz, Projected Capacitive Touch, 9~36V DC input with adapter, Aluminum chassis
NPP185P02	18.5" Full HD Fanless Panel PC withW Intel Alder Lake-N Processor N97 2.0 GHz, 8GB DDR4 3200MHz, Projected Capacitive Touch, 9~36V DC input with adapter, Aluminum chassis
NPP185P03	18.5" Full HD Fanless Panel PC with Intel Alder Lake-N Core i3-N305 1.8GHz, 8GB DDR4 3200MHz, Projected Capacitive Touch, 9~36V DC input with adapter, Aluminum chassis



P01



P02 / P03

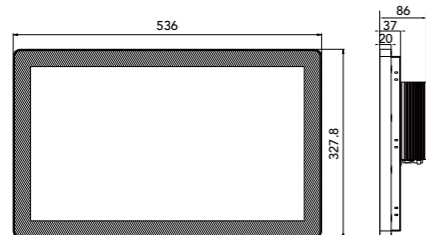
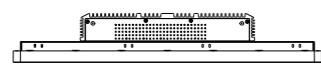
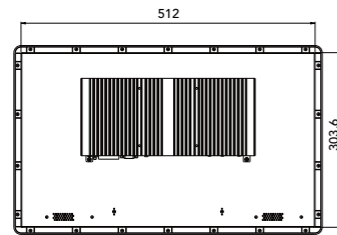
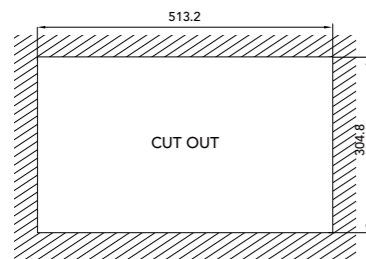

Features

Intel® Celeron® J6412 Processor Fanless Industrial Modular Panel PC



A Siemens Certified Edge Device

- Intel® Celeron® Processor J6412 (Elkhart Lake) 2.0 GHz (up to 2.6 GHz)
- 21.5" Full HD 1920x1080, TFT-LCD
- Resistive Touch / Projected Capacitive Touch
- IP66-rated aluminum front bezel and steel chassis
- GbE Ethernet ports x 2
- COM port x 4 (RS-232 x 2, RS-232/422/485 x 2)
- USB x 5 (3.2 Gen1 x 4, 2.0 x 1)
- DC 9~36V wide range power input
- Fan-less, modular detachable design
- VESA mounting 100x100mm / Panel mounting

Intel® Processor N-series N97 Fanless Industrial Modular Panel PC

- Intel® Alder Lake-N Processor N97 2.0 GHz (up to 3.6 GHz)
- 21.5" Full HD 1920x1080, TFT-LCD
- Resistive Touch / Projected Capacitive Touch
- IP66-rated aluminum front bezel and steel chassis
- 2.5 GbE Ethernet ports x 2
- COM port x 2 (RS-232 x 1, RS-232/422/485 x 1)
- USB x 6 (3.2 Gen1 x 2, 3.2 Gen2 x 2, 2.0 x 2)
- DC 9~36V wide range power input
- Fan-less, modular detachable design
- VESA mounting 100x100mm / Panel mounting

Intel® Core™ i3-N305 Processor Fanless Industrial Modular Panel PC

- Intel® Alder Lake-N Core i3-N305 1.8 GHz (up to 3.8 GHz)
- 21.5" Full HD 1920x1080, TFT-LCD
- Resistive Touch / Projected Capacitive Touch
- IP66-rated aluminum front bezel and steel chassis
- 2.5 GbE Ethernet ports x 2
- COM port x 2 (RS-232 x 1, RS-232/422/485 x 1)
- USB x 6 (3.2 Gen1 x 2, 3.2 Gen2 x 2, 2.0 x 2)
- DC 9~36V wide range power input
- Fan-less, modular detachable design
- VESA mounting 100x100mm / Panel mounting

Specifications

Model No.	NPP-215P01	NPP-215P02	NPP-215P03	
System	CPU	Intel® Celeron® J6412 2.0GHz, quad-core, 4 threads, (up to 2.6GHz)	Intel® Alder Lake-N Processor N97 2.0GHz, quad-core, 4 threads, (up to 3.6GHz)	
	System Chipset	SoC		
	System Memory	1 x SO-DIMM, DDR4 3200MHz, up to 32GB	1 x SO-DIMM, DDR5 4800MHz, up to 16GB	
Storage	SSD	1 x 2280 M.2 M-key (PCIe x2, SATA 6Gb/s)	1 x 2280 M.2 B key (SATA/PCIe x1)	
Expansion	Expansion Slot	1 x Full-size mini PCIe	1 x M.2 E key (PCIe x1, USB 2.0), 2230	
Display & Touch Screen	LCD Size	21.5" TFT-LCD		
	Luminance (cd/m ²)	500 (Typ.)		
	Backlight Lifetime (hrs)	50000		
	Contrast	1000:1 (Typ.)		
	Max. Colors	16.7M		
	Max. Resolution	1920x1080		
	Viewangle (H°/V°)	178 / 178		
	Touch Type	Projected Capacitive Touch		
	Touch Interface	USB		
I/O Interface	Light Transmission (%)	Over 84%		
	Audio	1 x Line Out	1 x Line Out	
	HDMI 2.0	2	1	
	Display Port	-	1	
	LAN (RJ45)	2 x GbE	2 x 2.5GbE	
	Power	1 x 2 pins terminal block for external power switch 1 x 3 pins terminal block power connector 1 x power switch on/off	1 x 2 pins terminal block for external power switch 1 x 3 pins terminal block power connector 1 x power switch on/off	
	Serial	1 x DB9 (RS-232/422/485 & RI/5V/12V) 1 x DB9 (RS-232/422/485) 2 x DB9 (RS-232)	1 x DB9 (RS-232/422/485 & RI/5V/12V) 1 x DB9 (RS-232)	
	USB	4 x USB 3.2 Gen 1, 1 x USB 2.0	2 x USB 3.2 Gen 1, 2 x USB 3.2 Gen 2, 2 x USB 2.0	
	Power	Power Input	DC 9~36V	
		Power Consumption	90W	
Environment	Operating Temp.	0~50° C (32~122° F)		
	Operating Humidity	10 to 90% (non-condensing)		
	Storage Temp.	-20~60° C (-4~140° F)		
	Operating System	Windows 10 IoT, Debian 11		
	Certification	CE/FCC		
Mechanical	Construction	Aluminum front bezel and steel chassis		
	IP Rating	Front Panel IP66		
	Mounting	Panel Mount / VESA Mount		
	Dimension(mm)	536 x 327.8 x 86		
	Net Weight(Kgs)	7.2		

Ordering Information

NPP215P01	21.5" Full HD Fanless Panel PC with Intel Celeron J6412 2.0 GHz, 8GB DDR4 3200MHz, Projected Capacitive Touch, 9~36V DC input with adapter, Aluminum chassis
NPP215P02	21.5" Full HD Fanless Panel PC withW Intel Alder Lake-N Processor N97 2.0 GHz, 8GB DDR4 3200MHz, Projected Capacitive Touch, 9~36V DC input with adapter, Aluminum chassis
NPP215P03	21.5" Full HD Fanless Panel PC with Intel Alder Lake-N Core i3-N305 1.8GHz, 8GB DDR4 3200MHz, Projected Capacitive Touch, 9~36V DC input with adapter, Aluminum chassis

Industrial Panel PC

R12/ R15/ R16/ R17/ R19/ R21

Industrial Panel PC
R SERIES

Industrial Panel PC

R12/ R15/ R16/ R17/ R19/ R21

Industrial Panel PC
R SERIES



Intel® Celeron® N2930/Atom E3845 Fanless Industrial Panel PC

Features

- 12.1"~ 21.5" Industrial Compact Size Panel PC
- Intel Celeron N2930(1.83GHz) CPU built-in / Atom E3845 (1.91GHz) for option
- Onboard 4GB DDR3L 1333MHz/8GB(option)
- Flat Front Panel Touch Screen and Fanless Design
- DC 9~36V Wide-Ranging Power Input
- IP66 Compliant Front Panel
- Optional Projected Capacitive Touch Screen Support 7H Anti-Scratch Surface Suitable for HMI / SCADA applications with iFACE Designer®



I/O View



R12



R15



R16



R17



R19



R21

Specifications

Model No.	R12	R15	R16	R17	R19	R21	
System	Processor						
	Intel® Celeron® N2930 Processor (2M Cache, 1.83GHz) Atom E3845 Processor (2M Cache, 1.91GHz)						
	Memory						
2 x DDR3L SO-DIMM, up to 8GB, default 4GB							
Thermal Design							
Fanless							
Display & Touch Screen	Display Size	12.1" TFT-LCD	15" TFT-LCD	15.6" TFT-LCD	17" TFT-LCD	19" TFT-LCD	21.5" TFT-LCD
	Max. Resolution	1024 x 768	1024 x 768	1920 x 1080	1280 x 1024	1280 x 1024	1920 x 1080
	Luminance (cd/m ²)	500	300	450	350	350	250
	Contrast	1000:1	1000:1	800:1	1000:1	1000:1	1000:1
	Max. Color	16.2M	16.2M	16.2M	16.2M	16.7M	16.7M
	View Angle (H/V)	178 /178	176 /176	170 /170	170 /160	170 /160	178 /178
	Backlight Lifetime (hrs) (High Brightness optional)	50,000	70,000	50,000	30,000	50,000	50,000
	Touch Type	Resistive Touch / Projected Capacitive Touch (for P model)					
	Touch Interface	USB					
	Light Transmission (%)	Resistive Touch: over 80% / Projected Capacitive Touch: over 90%					
	Point of touch	10 (for P model) / 1 (for R model)					
I/O Interface	USB 3.0	2 x USB 3.0 type A					
	USB 2.0	-					
	RS-232/422/485 Selectable under BIOS	1					
	RS-232	1					
	LAN	2 x GbE LAN RJ-45					
	Additional Graphics	-					
	Audio	1 x Audio Line Out					
	Digital I/O	-					
	Power Connector	1 x 3-pin DC power input terminal / 1 x 2-pin connector for power on/off button					
	Power Button	-					
Mechanical	Dimensions (mm)	319 x 245 x 51.7	410 x 310 x 54.67	412 x 277.5 x 58.9	439 x 348 x 64.8	468 x 380 x 64.8	557.3 x 362.3 x 64.8
	Net Weight (kgs)	3.1	3.1	4.9	6.02	6	7.5
Expansion	Internal Expansion Bus	1 x Mini-PCIe slot (full size) / 1 x Micro SIM slot					
	Expansion Slot	-					
	Wireless	Optional					
Storage Space	HDD	1 x 2.5" SATA3 HDD space					
	Removable	1 x Micro SD card slot, up to 32GB					
Power	Power Input Range	9~36V DC input					
Construction	Chassis Material	Aluminum Die-casting Chassis					
	Color (Front/Back)	Grey aluminium					
	IP Rating	IP66 Compliant Front Bezel					
	Mounting	Panel Mount, VESA 100 x 100					
Environmental	Operating Temperature	0~50°C / -20~60°C (option)					
	Storage Temperature	-30~70°C					
	Storage Humidity	10 to 90% @ 40°C, non-condensing					
	Certification	CE/FCC Class A/CB/UL					
	Software Support	iFace Designer® HMI Software Runtime					
Operating System Support	Windows 10 IoT						

Industrial Panel PC R12/ R15/ R16/ R17/ R19/ R21

Industrial Panel PC
R SERIES

Industrial Panel PC R12/ R15/ R16/ R17/ R19/ R21

Industrial Panel PC
R SERIES

R12

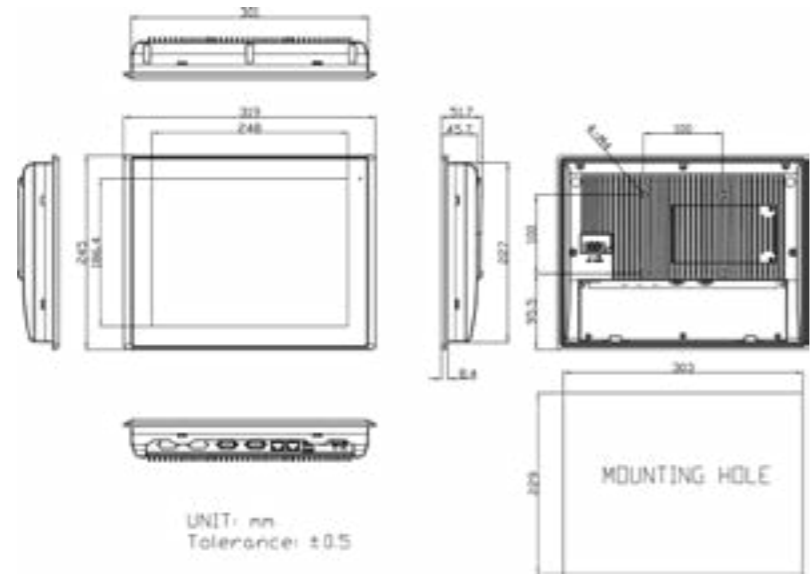

R17

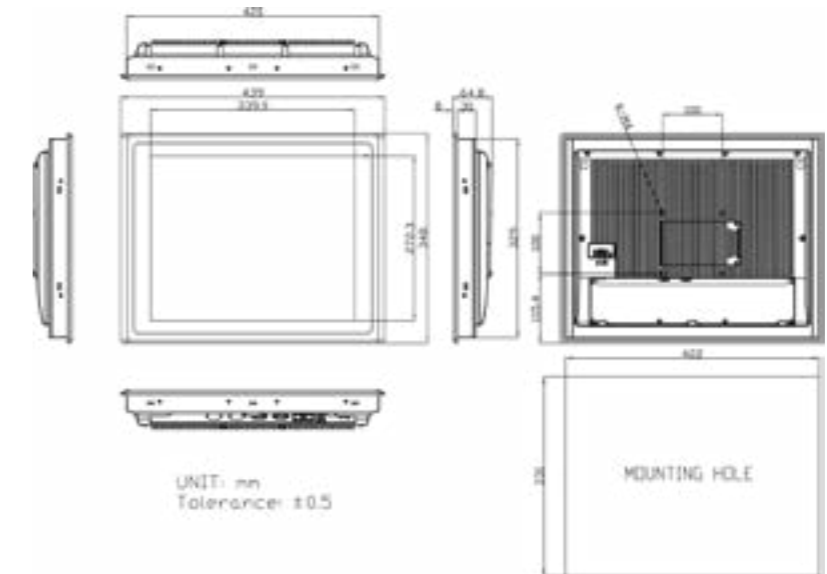

R15

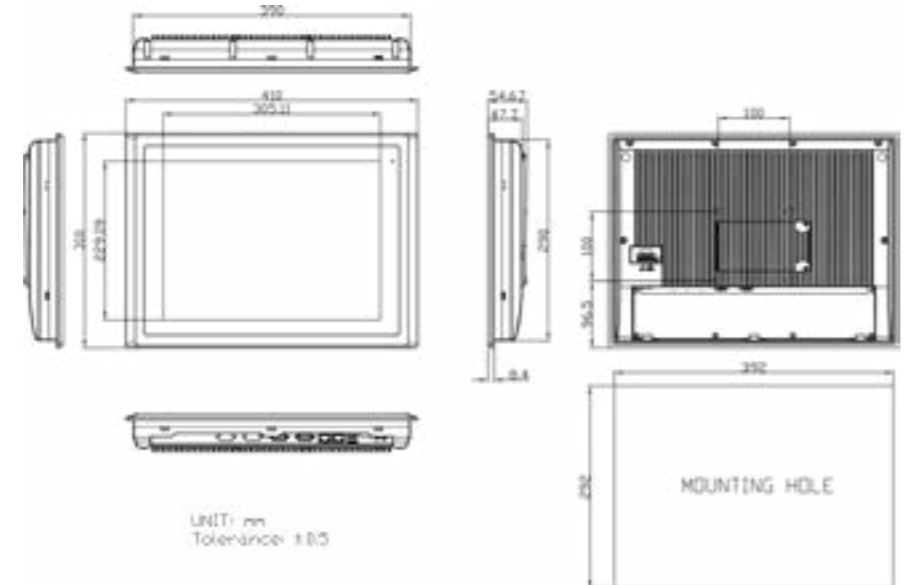

R19

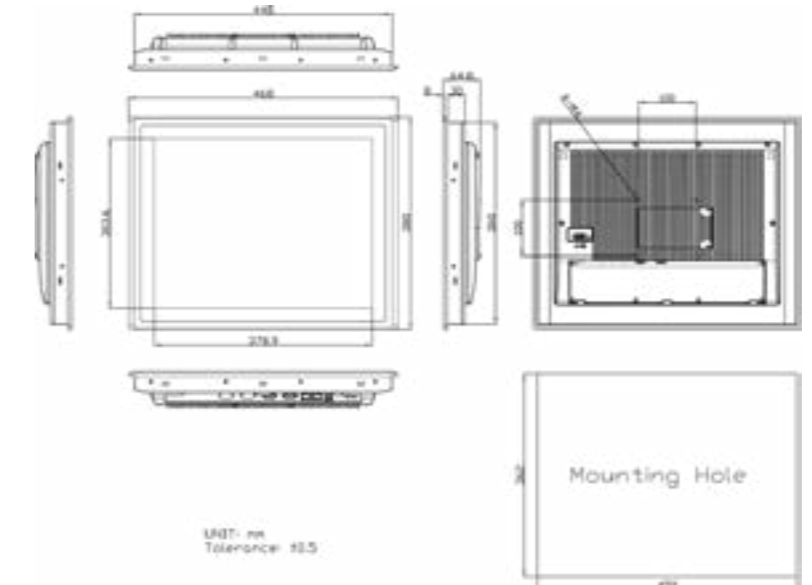

R16

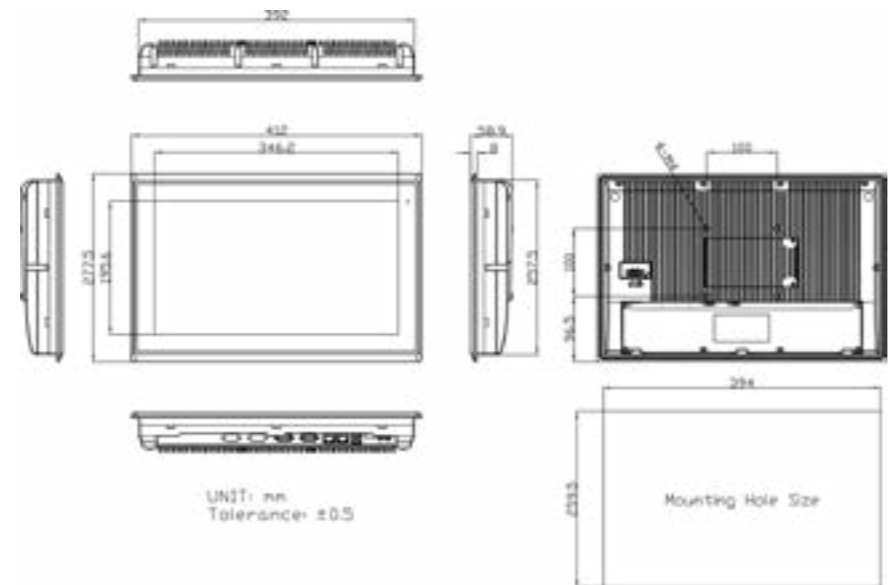

R21

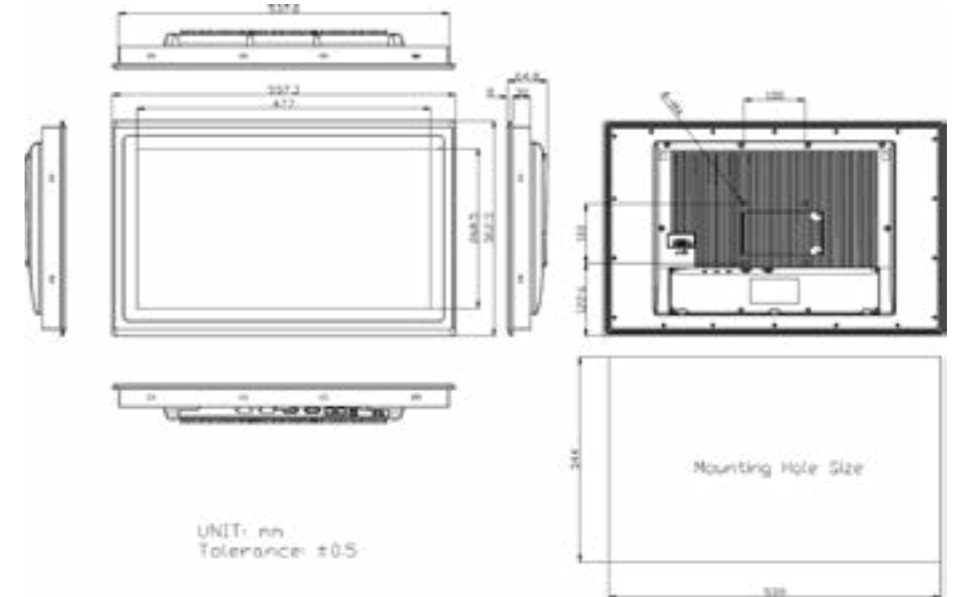

Industrial Panel PC

R12/ R15/ R16/ R17/ R19/ R21

Industrial Panel PC
R SERIES

Industrial Panel PC

R12/ R15/ R16/ R17/ R19/ R21

Industrial Panel PC
R SERIES

Ordering Information

R12-R	12.1" SVGA Fanless Panel PC with Intel N2930 1.83G CPU, 4GB DDR3L RAM, Resistive touch screen, DC 9~36V input with adapter, Aluminum chassis
R12-P	12.1" SVGA Fanless Panel PC with Intel N2930 1.83G CPU, 4GB DDR3L RAM, Projected Capacitive touch screen, DC 9~36V input with adapter, Aluminum chassis
R12-RH	12.1" SVGA Fanless Panel PC with Intel N2930 1.83G CPU, 4GB DDR3L RAM, Resistive touch screen, DC 9~36V input with adapter, Aluminum chassis, 1,000 nits LCD
R12-PH	12.1" SVGA Fanless Panel PC with Intel N2930 1.83G CPU, 4GB DDR3L RAM, Projected Capacitive touch screen, DC 9~36V input with adapter, Aluminum chassis, 1,000 nits LCD
R15-R	15" XGA Fanless Panel PC with Intel N2930 1.83G CPU, 4GB DDR3L RAM, Resistive touch screen, DC 9~36V input with adapter, Aluminum chassis
R15-P	15" XGA Fanless Panel PC with Intel N2930 1.83G CPU, 4GB DDR3L RAM, Projected Capacitive touch screen, DC 9~36V input with adapter, Aluminum chassis
R15-RH	15" XGA Fanless Panel PC with Intel N2930 1.83G CPU, 4GB DDR3L RAM, Resistive touch screen, DC 9~36V input with adapter, Aluminum chassis, 1,000 nits LCD
R15-PH	15" XGA Fanless Panel PC with Intel N2930 1.83G CPU, 4GB DDR3L RAM, Projected Capacitive touch screen, DC 9~36V input with adapter, Aluminum chassis, 1,000 nits LCD
R16-R	15.6" WXGA Fanless Panel PC barebone with Intel N2930 1.83G CPU, 2GB DDR3L RAM, Resistive touch screen, DC 9~36V input with adapter, Aluminum chassis
R16-P	15.6" WXGA Fanless Panel PC barebone with Intel N2930 1.83G CPU, 2GB DDR3 RAM, Projected Capacitive touch screen, DC 9~36V input with adapter, Aluminum chassis
R16-RH	15.6" WXGA fanless Panel PC barebone with Celeron N2930(1.83.GHz) CPU,4GB DDR3L RAM, Resistive touch screen, DC 9~36V input with adapter,Aluminum chassis, 1,000 nits LCD
R16-PH	15.6" WXGA fanless Panel PC barebone with Celeron N2930(1.83.GHz) CPU,4GB DDR3L RAM, Projected Capacitive touch, DC 9~36V input with adapter, Aluminum chassis, 1,000 nits LCD
R17-R	17" SXGA Fanless Panel PC with Intel N2930 1.83G CPU, 4GB DDR3L RAM, Resistive touch screen, DC 9~36V input with adapter, Aluminum chassis
R17-P	17" SXGA Fanless Panel PC with Intel N2930 1.83G CPU, 4GB DDR3L RAM, Projected Capacitive touch screen, DC 9~36V input with adapter, Aluminum chassis
R17-RH	17" SXGA Fanless Panel PC with Intel N2930 1.83G CPU, 4GB DDR3L RAM, Resistive touch screen, DC 9~36V input with adapter,Aluminum chassis, 1,000 nits LCD
R17-PH	17" SXGA Fanless Panel PC with Intel N2930 1.83G CPU, 4GB DDR3L RAM, Projected Capacitive touch screen, DC 9~36V input with adapter, Aluminum chassis, 1,000 nits LCD
R19-R	19" SXGA Fanless Panel PC with Intel N2930 1.83G CPU, 4GB DDR3L RAM, Resistive touch screen, DC 9~36V input with adapter, Aluminum chassis
R19-P	19" SXGA Fanless Panel PC with Intel N2930 1.83G CPU, 4GB DDR3L RAM, Projected Capacitive touch screen, DC 9~36V input with adapter, Aluminum chassis
R19-RH	19" SXGA Fanless Panel PC with Intel N2930 1.83G CPU, 4GB DDR3L RAM, Resistive touch screen, DC 9~36V input with adapter, Aluminum chassis, 1,000 nits LCD
R19-PH	19" SXGA Fanless Panel PC with Intel N2930 1.83G CPU, 4GB DDR3L RAM, Projected Capacitive touch screen, DC 9~36V input with adapter, Aluminum chassis, 1,000 nits LCD

R21-R	21.5" FHD Fanless Panel PC with Intel N2930 1.83G CPU, 4GB DDR3L RAM, Resistive touch screen, DC 9~36V input with adapter, Aluminum chassis
R21-P	21.5" FHD Fanless Panel PC with Intel N2930 1.83G CPU, 4GB DDR3L RAM, Projected Capacitive touch screen, DC 9~36V input with adapter, Aluminum chassis
R21-RH	21.5" FHD Fanless Panel PC with Intel N2930 1.83G CPU, 4GB DDR3L RAM, Resistive touch screen, DC 9~36V input with adapter, Aluminum chassis, 1,000 nits LCD
R21-PH	21.5" FHD Fanless Panel PC with Intel N2930 1.83G CPU, 4GB DDR3L RAM, Projected Capacitive touch screen, DC 9~36V input with adapter, Aluminum chassis, 1,000 nits LCD

Protocol Conversion Gateway GW-01

Gateway
SERIES

PCI-E Protocol Conversion Card GP01

Gateway
SERIES

NEW Available in
2024 Q1



Features

- TI Sitara™ AM3352 ARM® Cortex™-A8 1GHz CPU
- Ethernet ports x 2 ; COM port x 2 (DB9 x1)
- 19.2 ~ 28.8V, Isolated Power
- Isolated Communication Port
- Fan-less, compact design
- PCB conformal coating protection
- -20°C~70°C wide operating temperature
- Metal chassis, DIN-rail mounting
- Powered by Novakon Software iM-Connect®

Specifications

CPU	TI Sitara™ AM3352 ARM® Cortex™-A8 1GHz CPU
Memory	512MB SDRAM (1GB option)
Thermal Design	Fanless
Conformal Coating	Yes
Storage	4GB eMMC (8GB option)
USB Host	1
Serial Port	1 x RS-232, 1 x RS-422/485
Ethernet	2 x 10/100 Mbit Ethernet Port
Power Connector	3-Pin terminal block
Dimensions (mm)	120 x 85.45 x 31.25
Net Weight (kgs)	0.45
Power Input Range	19.2 ~ 28.8V, Isolated Power
LED Indicator	1
Chassis Material	SECC
Mounting	25mm DIN-rail mounting
Accessories	Setup Manual x 1, 25mm DIN Rail Clip x 1, M3x6mm flat head screw x 2, Recovery USB Drive x 1
Operating Temp.	-20°C~70°C
Storage Temp.	-20°C~80°C
Storage Humidity	10%~90% @40°C (non-condensing)
ESD Protection	Contact Discharge 4kV, Air Discharge 8kV
Certification	CE/FCC (EN 61000-6-4, EN 61000-6-2, EN55032, EN55035), Class A
Software	iM-Connect®

Ordering Information

GW-01

Compact DIN-rail Gateway with ARM Cortex-A8 (1GHz) CPU, 512MB RAM, 4GB eMMC, dual Ethernet ports, 19.2 ~ 28.8V isolated power, metal chassis, iM-Connect®



Features

- TI Sitara™ AM3352 ARM® Cortex™-A8 1GHz CPU
- COM port x 1 (RS232 x 1, RS422/485 x 1)
- Memory 512MB DDR3 800MHz
- Onboard Flash 4GB, 8bit Embedded MMC
- PCI Express Gen 2 system interface bus

Specifications

CPU	TI Sitara™ AM3352 ARM® Cortex™-A8 1GHz CPU
Memory	512MB DDR3 800MHz
Onboard Flash	4GB, 8bit Embedded MMC
F-RAM	256-Kbit (32K x 8)
Serial Number IC	Yes
LED	Power LED , Run LED
COM1	RS232 x 1, RS422/485 x 1
Ethernet	10/100Mbit x 2
PCI Express	PCI Express Gen 2 system interface bus
Operating Temp.	-20~70°C
Storage Temp.	-40~90°C
Moisture	10% ~ 90% RH (non-condensing) @40°C
Support OS	Windows 10 IoT
Software	iM-Connect®

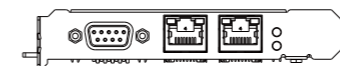
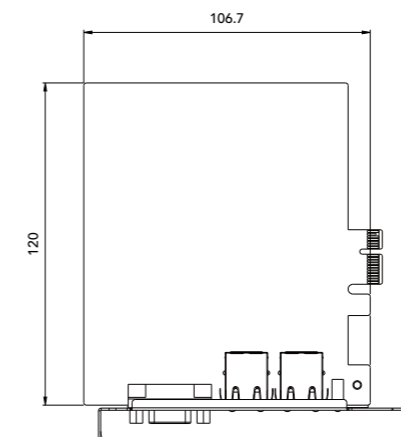
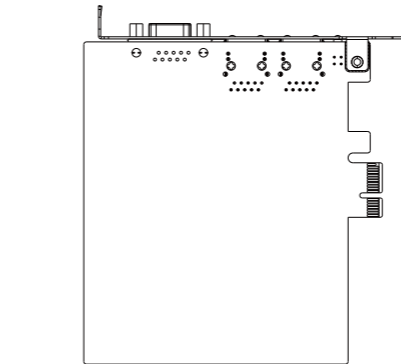

Ordering Information

GP01

ARM Cortex-A8 (1GHz) CPU, 512MB RAM, 4GB eMMC, dual Ethernet ports, 19.2 ~ 28.8V isolated power, metal chassis, iM-Connect®

NBP-01



Features

Intel® Celeron® J6412 Processor Embedded Box PC

- Intel® Celeron® Processor J6412 (Elkhart Lake)
- 2.0 GHz (up to 2.6 GHz)
- GbE Ethernet ports x 2
- COM port x 4 (RS-232 x 2, RS-232/422/485 x 2)
- USB x 5 (3.2 Gen1 x 4, 2.0 x 2)
- DC 9~36V wide range power input
- Fan-less, modular detachable design
- VESA mounting 100x100mm / Panel mounting

NBP-02/ 03



Intel® Processor N-series N97 Embedded Box PC

- Intel® Alder Lake-N Processor N97 2.0 GHz (up to 3.6 GHz)
- 2.5 GbE Ethernet ports x 2
- COM port x 2 (RS-232 x 1, RS-232/422/485 x 1)
- USB x 6 (3.2 Gen1 x 2, 3.2 Gen2 x 2, 2.0 x 6)
- DC 9~36V wide range power input
- Fan-less, modular detachable design
- VESA mounting 100x100mm / Panel mounting

Intel® Core™ i3-N305 Processor Embedded Box PC

- Intel® Alder Lake-N Core i3-N305 1.8 GHz (up to 3.8 GHz)
- 2.5 GbE Ethernet ports x 2
- COM port x 2 (RS-232 x 1, RS-232/422/485 x 1)
- USB x 6 (3.2 Gen1 x 2, 3.2 Gen2 x 2, 2.0 x 6)
- DC 9~36V wide range power input
- Fan-less, modular detachable design
- VESA mounting 100x100mm / Panel mounting

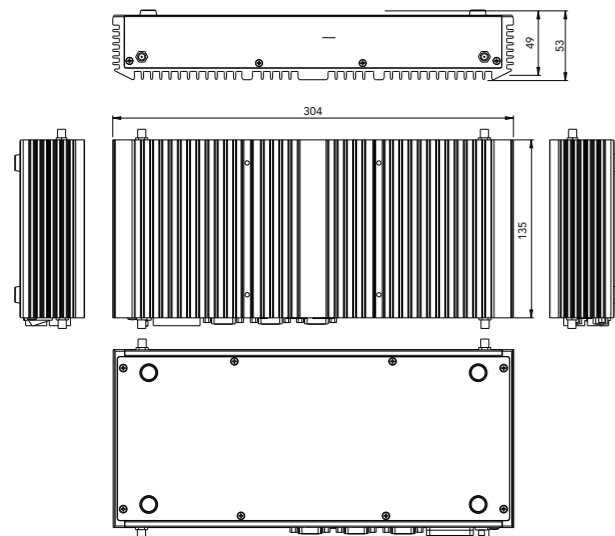

Specifications

Model No.	NBP-01	NBP-02	NBP-03	
System	CPU	Intel® Celeron® J6412 2.0GHz, quad-core, 4 threads, (up to 2.6GHz)	Intel® Alder Lake-N Processor N97 2.0GHz, quad-core, 4 threads, (up to 3.6GHz)	Intel® Alder Lake-N Core i3-N305 1.8GHz, 8 cores, 8 threads, (up to 3.8GHz)
	System Chipset	SoC		
	System Memory	2 x SO-DIMM, DDR4 3200MHz, up to 32GB	1 x SO-DIMM, DDR5 4800MHz, up to 16GB	1 x SO-DIMM, DDR5 4800MHz, up to 16GB
Storage	SSD	1 x 2280 M.2 M-Key (PCIe x2, SATA 6Gb/s)	1 x 2280 M.2 B key (SATA/PCIe x1)	1 x 2280 M.2 B key (SATA/PCIe x1)
Expansion	Expansion Slot	1 x Full-size mini PCIe	1 x M.2 E key (PCIe x1, USB 2.0), 2230	1 x M.2 E key (PCIe x1, USB 2.0), 2230
I/O Interface	Audio	1 x Line Out		
	HDMI 2.0	2	1	
	Display Port	-	1	
	LAN (RJ45)	2 x GbE	2 x 2.5GbE	
	Power	1 x 2 pins terminal block for external power switch 1 x 3 pins terminal block power connector 1 x power switch on/off	1 x 2 pins terminal block for external power switch 1 x 3 pins terminal block power connector 1 x power switch on/off	
	Serial	1 x DB9 (RS-232/422/485 & RI/5V/12V) 1 x DB9 (RS-232/422/485) 2 x DB9 (RS-232)	1 x DB9 (RS-232/422/485 & RI/5V/12V) 1 x DB9 (RS-232)	
Power	USB	4 x USB 3.2 Gen 1, 2 x USB 2.0	2 x USB 3.2 Gen 1, 2 x USB 3.2 Gen 2, 6 x USB 2.0	
	Power Input	DC 9~36V		
Environment	Power Consumption	90W		
	Operating Temp.	0~50° C (32~122° F)		
	Operating Humidity	10 to 90% (non-condensing)		
	Storage Temp.	-20~60° C (-4~140° F)		
Mechanical	Operating System	Windows 10 IoT, Debian 11		
	Certification	CE/FCC		
	Construction	Aluminum front bezel and steel chassis		
Mechanical	IP Rating	Front Panel IP66		
	Mounting	VESA mounting 100x100mm / Panel mounting		
	Dimension(mm)	304(W) x 135(H) x 49(D)		
	Net Weight(Kgs)	2.1		

Ordering Information

NBP-P01	Intel Celeron J6412 2.0 GHz, 8GB DDR4 3200MHz, 9~36V DC input with adapter, Aluminum chassis
NBP-P02	Intel Alder Lake-N Processor N97 2.0 GHz, 8GB DDR4 3200MHz, 9~36V DC input with adapter, Aluminum chassis
NBP-P03	Intel Alder Lake-N Core i3-N305 1.8GHz, 8GB DDR4 3200MHz, 9~36V DC input with adapter, Aluminum chassis

Built-in PLC drivers and open industrial communication protocols.



Brand	Series	Support Models
Allen-Bradley	ControlLogix, CompactLogix Ethernet	All models
	MicroLogix DF1 RS232	All models
	MicroLogix Ethernet	All models
	Micro800/850 Ethernet	All models
	PLC5 DF1 CRC	All models
Beckhoff	TwinCAT 2/3 Runtime	All models
	TwinCAT 2/3 SoftPLC	All models
CODESYS	CoDeSys V3	Ethernet over ARTI
Delta	DVP	All models
FATEK	FBs/Fbe/B1/B1z	All models
	FBs/Fbe/B1/B1z TCP	All models
Hitachi	MICRO-EH/EHV UDP	All models
	MICRO-EH/EHV TCP	All models
	MICRO-EH/EHV	All models
HUST	H Series CNC Controller	H4D Series/H6D Series
	A6 CNC Controller	A6 Series
KEYENCE	KV-1000	All models
	KV-L20V Host Link/KV-nano	All models
	KV-3000/5000/5500 Series	All models
	KV-7300/7500/8000 Series	All models
	KV-NC1EP	All models
KOYO	SU/DL Series	All models
Lust	LustBus ServoC/CDE Series	All models
Mitsubishi	A Series/J71UC24 Computer Link	All models
	A Series/J71 for AnA/AnU	All models
	A Series/J71 Format4	All models
	FR Series/A700	All models
	FX Series	All models
	FX/FX2N Series Computer Link	All models
	FX2N Series	All models
	FX3U Series	All models
	FX3U Series Computer Link	All models
	FX3U Ethernet	All models
	FX5U Ethernet	All models
Q Series	All models	

Mitsubishi	Q Series Computer Link	All models
	Q Series Ethernet	All models
	FX5U Ethernet	All models
	Servo MR-J4	All models
MODBUS	MODBUS ASCII Slave	All models
	MODBUS ASCII Master	All models
	MODBUS ASCII Client	All models
	MODBUS ASCII Server	All models
	MODBUS RTU Slave	All models
	MODBUS RTU Master	All models
	MODBUS RTU Client	All models
	MODBUS RTU Server	All models
	MODBUS TCP Slave	All models
	MODBUS TCP Master	All models
MOTRONA	MKS MC700 Motion Controller	All models
Omron	C Series	TPM1A, CP1E, CP1L
	CS/CJ Series	All models
	CS/CJ Series FINS TCP	All models
	NX/NJ Series EtherNet/IP	All models
OPTEX	CD33 Series Sensor	All models
	CD5 Series Sensor	All models
Panasonic	FP Series	All models
	FP TCP	All models
Siemens	S7-200	All models
	300/1200/1500 (ISO on TCP)	All models
Toshiba	TMFCD91A	All models
Vigor	VB/VH/M Series	All models
	VS Series	All models
	VS TCP	All models
	VS UDP	All models
Yamatake	DPC30	All models
	DMC50	All models
	SDC35/SDC45	All models
	NX-D15/25	All models
YASKAWA	MP2000 Series Extension	All models
	MP3000 Series Extension	All models
	MP2000 Extension UDP	All models
Yokogawa	FA-M3 Series TCP	All models
Accessories	Led Controller	EV12048W11JX
	Scale	SKW-II
	Barcode Reader	All models
	Barcode Printer	All models