

- (DE) Überspannungsableiter
- (EN) Surge protective device
- (FR) Parafoudre
- (CS) Svodič přepětí

6S5037f
L
W
H

SPN115, SPN117

EN 61 643-11 IEC 61 643-11	Type 2 Class II
U_n	230/400 V (50/60 Hz) Tolerance: 0V... U_c
I_{pe}	<0,5 mA
Humidity	5%...95%
9 °C	-40/+80 °C
Ports	1
IP code	20 (built in)
LxWxH	86,5x17,5x60 mm

 PZ 2 4 Nm 14 mm 14 mm	min. L, N, \perp	1,5 mm ²
	max. L, N, \perp	25 mm ² 35 mm ²

Coordination / Koordination / Energetická koordinace

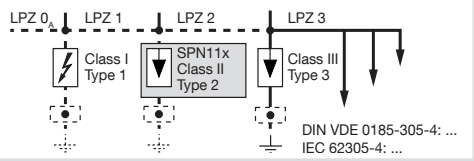

Indoor use only - There is no distance from the SPD to any earthed conductive surface required

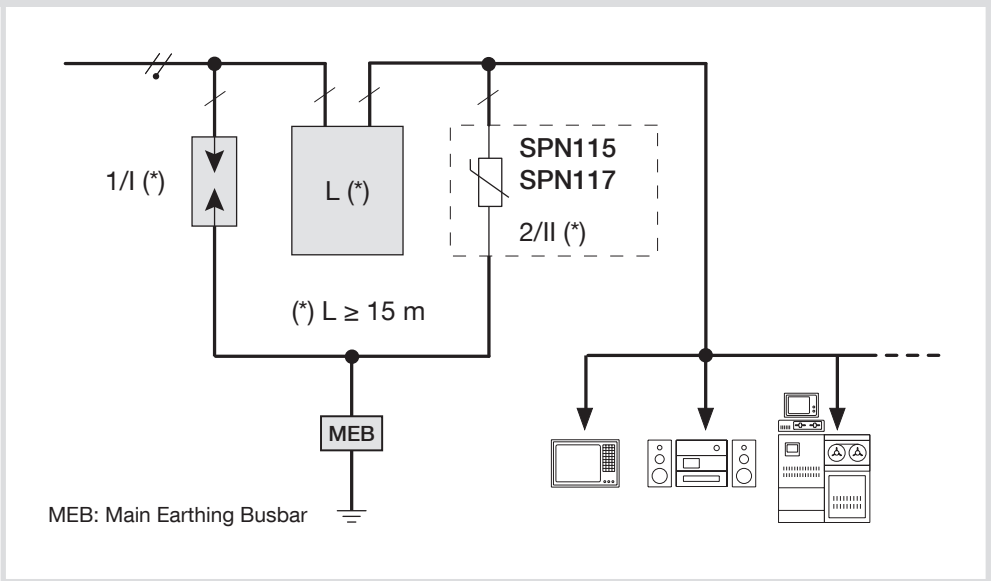

MEB: Main Earthing Busbar

	U_n	U_c	I_{max} (8/20 μ s)	I_n (8/20 μ s)	U_p	I_{scr}	max \Rightarrow	1 P
SPN115 SPN117	230 V (50/60 Hz)	275 V (50/60 Hz)	40 kA	20 kA	$\leq 1,5$ kV	50 kA _{rms}	125 A gG	\perp SPN015

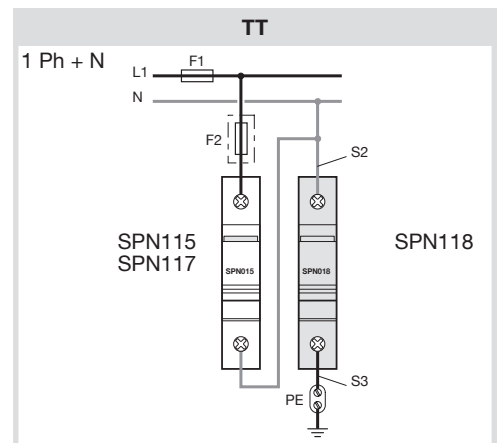
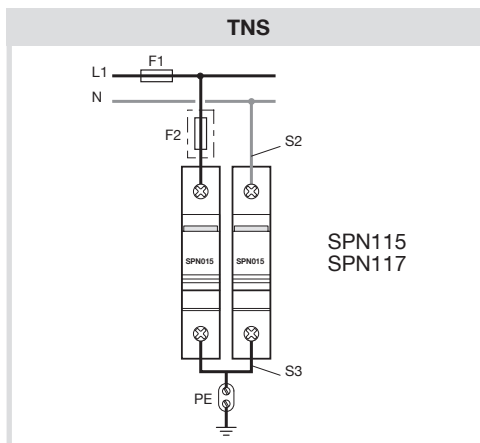
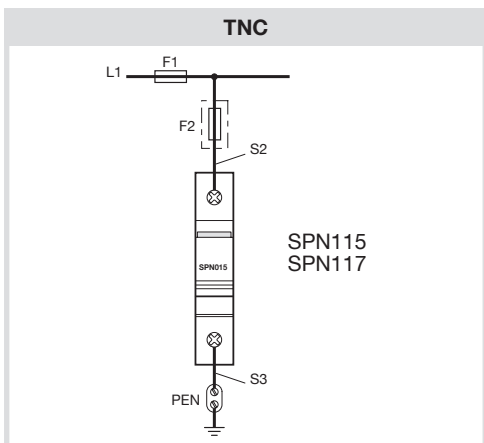

(DE) Information

1/I*: Blitzstromableiter (Grobschutz)
2/II*: Überspannungsableiter (Mittelschutz).
Leitungslänge $L \geq 15$ m nur erforderlich bei SP120, SP150 oder SP320 als 1/I.

(EN) Information

1/I*: lightning surge arrester (main protection)
2/II*: overvoltage protection device (medium protection).
Cable length $L \geq 15$ m only required if SP120, SP150 or SP320 is used for 1/I.

(FR) Information

1/I*: parafoudre (protection de tête)
2/II*: limiteur de surtension (protection secondaire).
Une longueur de câble $L \geq 15$ m est recommandée lors de l'utilisation du SP120, SP150 ou SP320 (1/I).

(CS) Informace

1 / I*: Svodič bleskových proudů (hrubá ochrana)
2 / II*: Svodič přepětí (střední ochrana)
Délka kabelu $L \geq 15$ m je vyžadováno pouze v případě použití SP120, SP150 nebo SP320 jako typ 1/I.

Backup fuse/Vorsicherung/Předjištění

Type	SPN115 SPN117
F1	F1 > 125 AgG ↓ F2 ≤ 125 AgG
F2	F1 ≤ 125 AgG ↓ ⊗
A	min. 6 mm ² Cu

F1 A/gG	S ₂ mm ²	S ₃ mm ²	F2 A/gG
25	4	6	-
35	4	6	-
40	4	6	-
50	6	6	-
63	10	10	-
80	10	10	-
100	16	16	-
125	16	16	-
>125	16	16	125

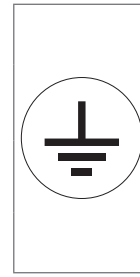

- Die Überspannungsableiter sind auf möglichst kurzem Weg zu erden.
- The surge protective device should be grounded using the shortest possible route.
- Les parafoudres doivent être mis à la terre par le plus court chemin possible.
- Svodič přepětí by měl být uzemněn v co nejkratší vzdálenosti

Fault indication

SPN115

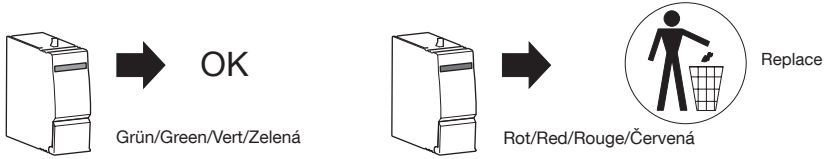

SPN117

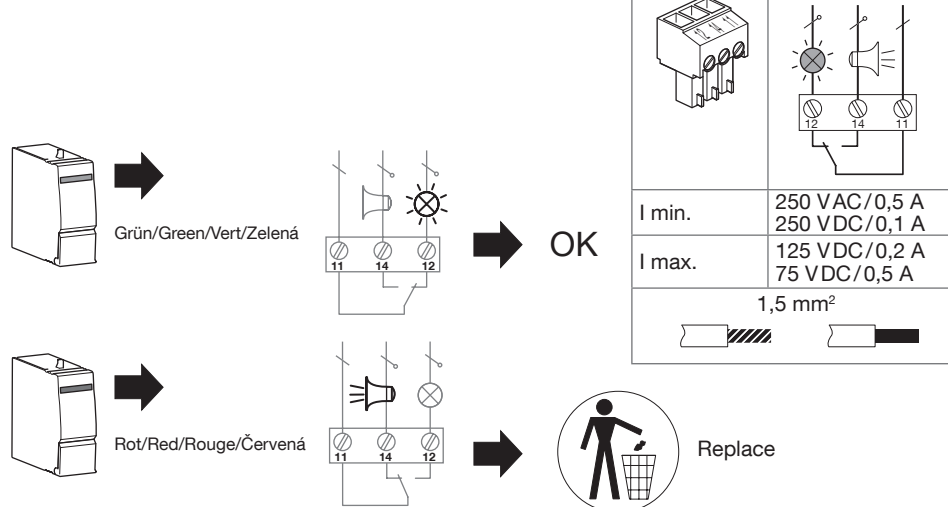

SPN015

