



	<h2>application software</h2>	
<ul style="list-style-type: none"> ▲ Manufacturers ▲ Hager Electro ▲ Physical sensors <ul style="list-style-type: none"> Weather data 	<p>KNX GPS Weather station <i>Electrical/Mechanical characteristics: see product user manual</i></p>	

	Product reference	Product designation	Application software ref	TP device  Radio device 
	TXE531	KNX GPS Weather station	STXE531 1.x Version	

Content

1. General	3
1.1 About this guide	3
1.2 About the program ETS	3
1.2.1 ETS compatibility	3
1.2.2 Application descriptions	3
1.3 Easy tool software appearance.....	3
2. General Description	4
2.1 Installation of the device	4
2.1.1 Overview presentation	4
2.1.2 Connection.....	5
2.1.3 Physical addressing	5
2.1.4 Status of the station in the event of a power failure and re-start.....	6
2.2 Function modules of the application	7
3. Programming by ETS.....	14
3.1 Parameters	14
3.1.1 General	14
3.1.1.1 Date and time.....	14
3.1.1.2 Time change	16
3.1.2 Weather data and alarms.....	19
3.1.2.1 Temperature measurement	20
3.1.2.2 Luminosity.....	21
3.1.2.3 Wind speed.....	22
3.1.2.4 Rain alarm.....	22
3.1.3 Façades and shading.....	23
3.1.4 Heat protection, heat recovery.....	32
3.1.5 Presence/Absence.....	36
3.1.6 Simulation	37
3.2 Communication objects.....	40
3.2.1 Weather data and alarms.....	42
3.2.2 Overall parameters	45
3.2.3 Façades and shading.....	50
3.2.4 Automatic control	54
3.2.5 Simulation	56
4. Programming by Easy Tool.....	64
4.1 Product overview	64
4.2 Date and time.....	66
4.3 Outdoor temperature - Temperature alarm	68
4.4 Luminosity - Day/night	70
4.5 Wind speed - Wind alarm.....	73
4.6 Rain alarm.....	75
4.7 Façades and shading.....	77
4.8 Heat protection/recovery.....	88
5. Appendix	95
5.1 Specifications.....	95
5.2 Characteristics	95
5.3 Index of objects.....	96

1. General

1.1 About this guide

The purpose of this manual is to describe the operation and configuration of KNX devices using ETS software or Easy tool software.

It consists of 4 parts:

- General information.
- The parameters and KNX objects available.
- The Easy tool configurations are available.
- Technical characteristics.

1.2 About the program ETS

1.2.1 ETS compatibility

The application programs are compatible with ETS4 and ETS5. They can be downloaded from our website under the order number.

ETS Version	File extension of compatible files
ETS4 (V4.1.8 or higher)	*.knxprod
ETS5	*.knxprod

1.2.2 Application descriptions

Application	Product reference
STXE531	TXE531

1.3 Easy tool software appearance

This product can also be configured using the TXA100 configuration tool. It is composed of a TJA665 configuration server.

Compatible software version TXA100: V 1.4.4 or higher

It is essential to update the configuration server software version.
(Please refer to the TXA100 user manual).

2. General Description

2.1 Installation of the device

2.1.1 Overview presentation

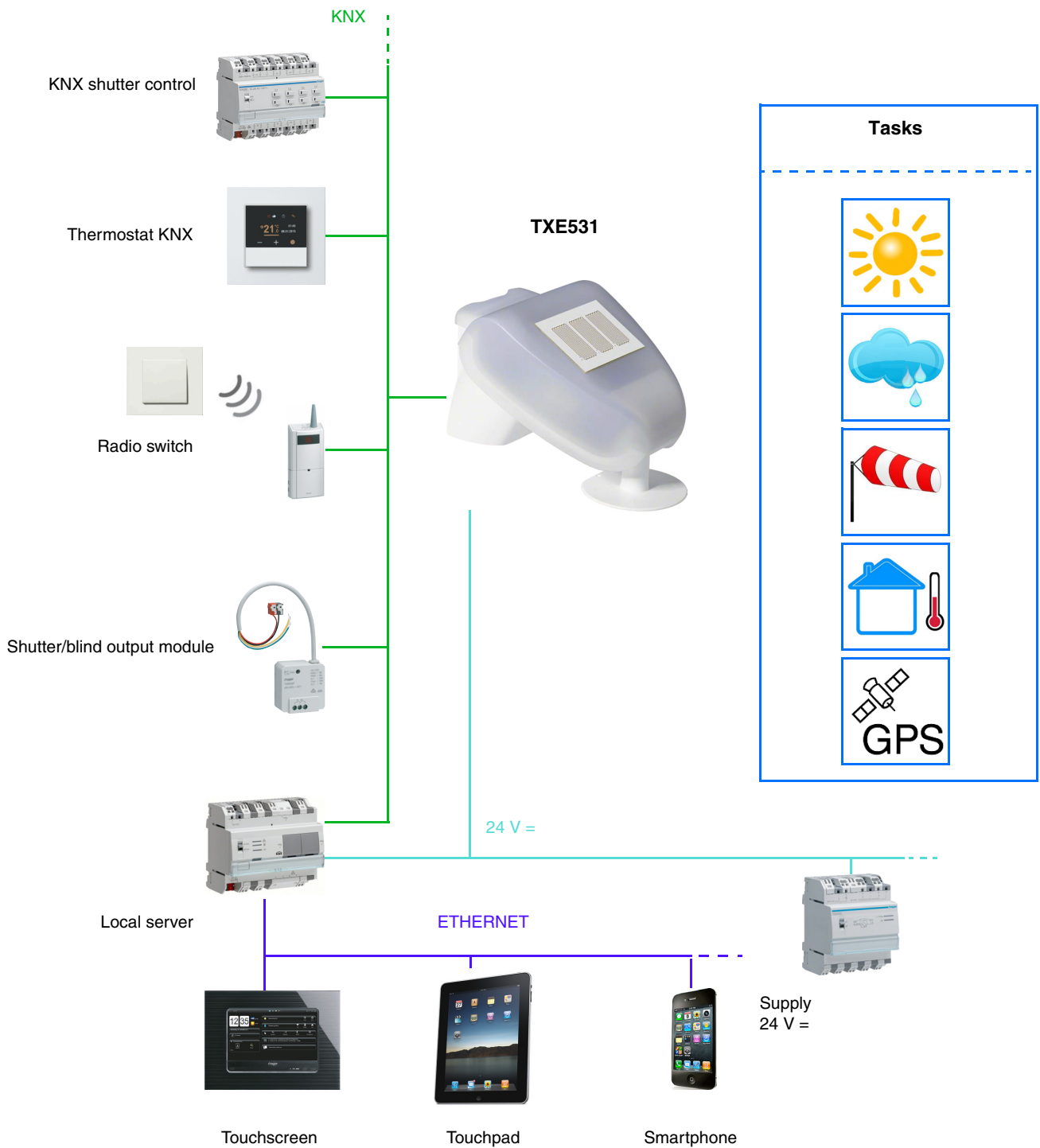

2.1.2 Connection

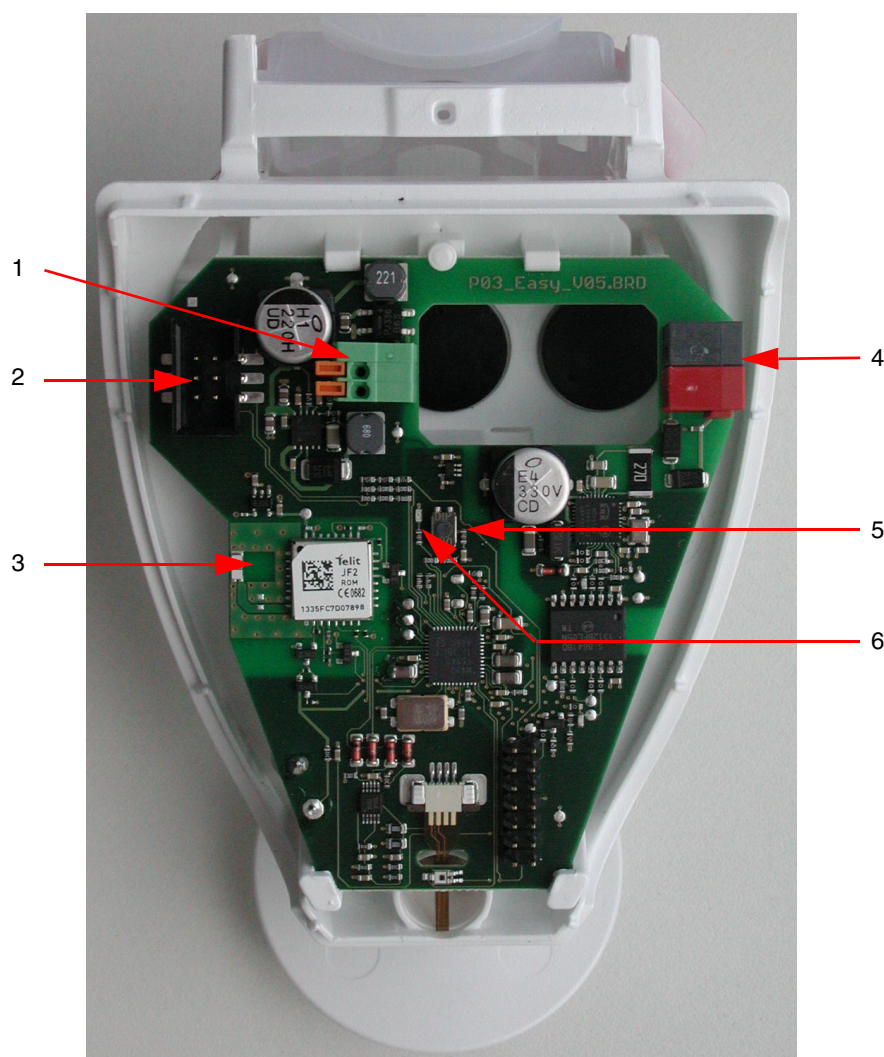

- 1 Spring terminal for power, for solid conductors up to 1.5 mm² or for stranded conductors
- 2 Location for the built-in rain sensor connector on the cover of the housing
- 3 GPS antenna
- 4 Terminal KNX +/-
- 5 Physical addressing button
- 6 Physical addressing LED

2.1.3 Physical addressing

In order to perform the physical addressing or to check whether or not the bus is connected, press the lighted push button (see chapter 2.1.2 for the button location).

Light on = bus connected and ready for physical addressing.

Programming mode is activated, until the physical address is transferred from ETS. Pressing the button again, exits programming mode.

2.1.4 Status of the station in the event of a power failure and re-start

- **Status of the station in the event of a power failure in the bus or auxiliary:** the device does not broadcast.
- **Status of the station in the event of power restoration to the bus or auxiliary and after programming or restarting:** The device sends all of the actions, as well as the switching outputs and statuses, according to the timelines defined below:

Tasks	Time
Rain, wind and temperature alarms Date and time Day/night Luminosity Wind speed measurement Precipitation detection Temperature recordings	25 s
Shading control Heat protection and heat recovery Presence/Absence	30 s

The date and time are emitted from the first GPS signal following power failure or downloading. The time to receive the first GPS signal can be up to 20 minutes.

2.2 Function modules of the application

The KNX-GPS weather station measures the temperature, wind speed and luminosity. It detects precipitations and receives the time and location data through the GPS signal. In addition, it calculates the exact position of the sun (azimuth and elevation) using the site coordinates and time.

All of the weather data is sent to the bus at regular intervals. This data can be received and operated by other KNX products or a supervision system that is able to define the thresholds and establish logical combinations from among several quantities to ultimately control the outputs depending on the threshold values.

The weather station enables direct control of the switch outputs thanks to the pre-defined alarm levels: rain and temperature alarms and 3 wind alarm levels. It can also ensure the shading or heat recovery functions by tracking the position of shutters or the tilt of slats for blinds.

The sensors, data operation electronics and bus coupler electronics are stored in the compact housing of the KNX-GPS station.

■ Luminosity and sun position

The light intensity is measured using a luminosity sensor. At the same time, the KNX-GPS weather station calculates the position of the sun (azimuth and elevation) using the time and location.

■ Wind speed measurement

The wind speed electronic record provides quiet and reliable operation, even during hail, snow and minus temperatures. Turbulence and upslope winds close to the weather station are also recorded. This information is transmitted periodically and can be used as a wind alarm control.

■ Precipitation detection

The surface of the sensor is heated so that only droplets and flakes are identified as precipitation, thereby disqualifying fog or thaw. When the rain or snow stops, the sensor dries quickly and indicates the end of precipitation. This information is transmitted periodically and can be used as a rain alarm control.

■ Temperature recordings

The outdoor temperature is measured using a sensor. This information is transmitted periodically and can primarily be used as a display or, for example, as a frost alarm control.

■ Operation associated with domovea

The quantities measured (lux °C m/s) can be used by domovea to configure the levels and control the ON/OFF outputs when the threshold is exceeded.

■ Date and time - GPS function

The weather station receives the date and time via its built-in GPS receiver. This allows it to manage the switch to daylight saving time between winter and summer.

■ Rain, wind and temperature alarms

This function issues an alarm according to the weather data gathered up to a predefined threshold.

There are 3 types of alarms:

- Rain alarm
- Temperature alarm
- Wind alarm defined by 3 adjustable thresholds

■ Shading control

This function manages up to 4 facades with several levels of shading depending on the angle of slat blinds or shutter closure.

■ Presence/Absence

This function is used to signal the presence or absence of the user to manage activation or deactivation of shading per façade, heat protection or heat recovery.

■ Heat protection and heat recovery

This function is involved in indoor temperature management, depending on the level of sunlight and the season. In summer, the heat protection function positions the shutters or blinds to prevent the part from becoming too warm. In winter, the heat recovery function opens the shutters or blinds to heat up the part using sunlight. For facade 1 only, the purpose of the weather station is to receive the ambient temperature of facade 1 (using a master part) to more accurately manage heat protection and recovery.

Communication objects

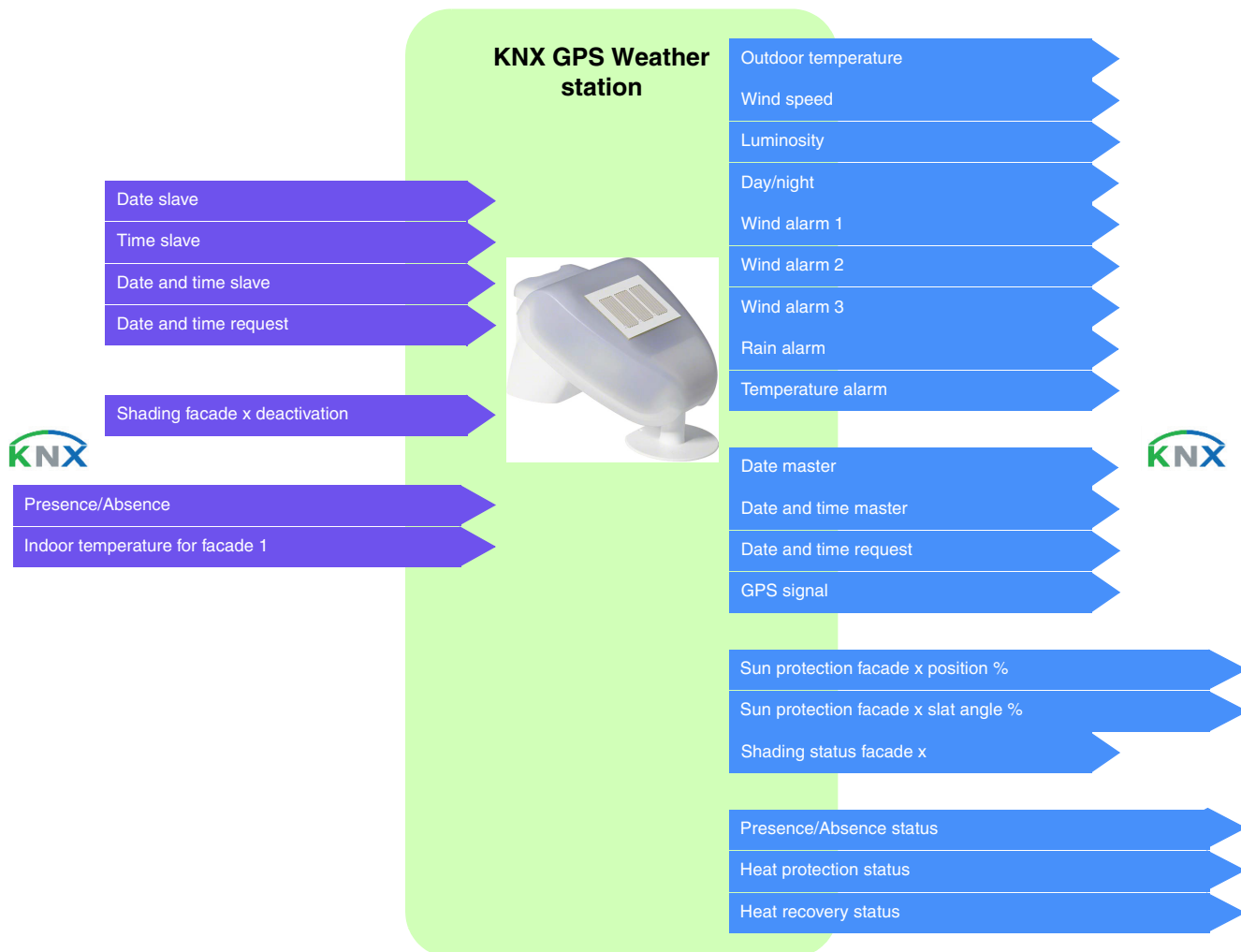

■ Simulation (only with ETS)

This function enables the installer to test the parameters of the weather station independently of the weather conditions. For this purpose the installer has several communication objects allowing weather conditions to be simulated (temperature, wind speed, luminosity, rain) the GPS coordinates, the date and time.

Communication objects: For the simulation



Shading-protection and heat recovery operation

The organisation chart below describes the global operating principle of the weather station with regard to shading, protection and heat recovery.

Principle:

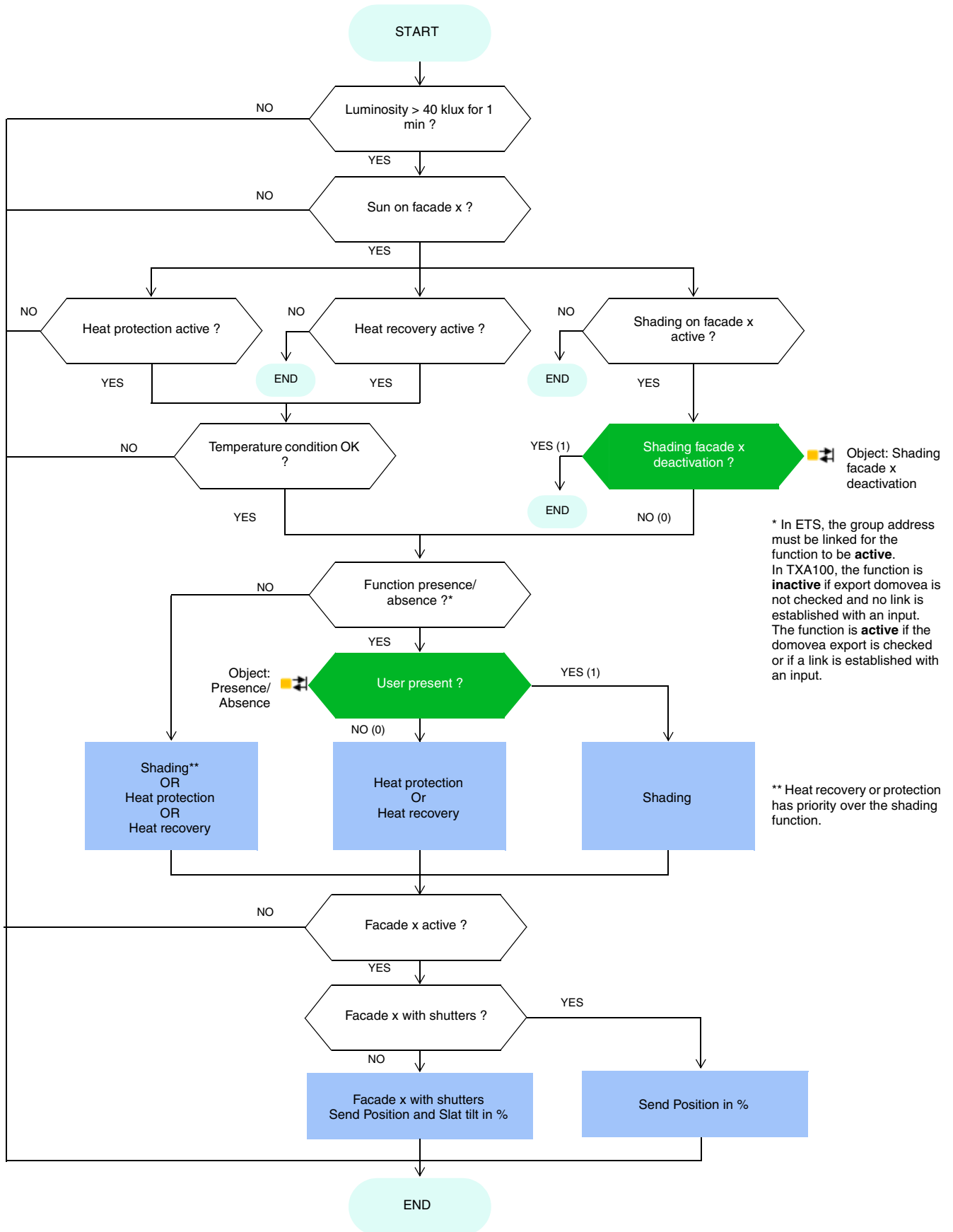

Operation without shading function

Principle:

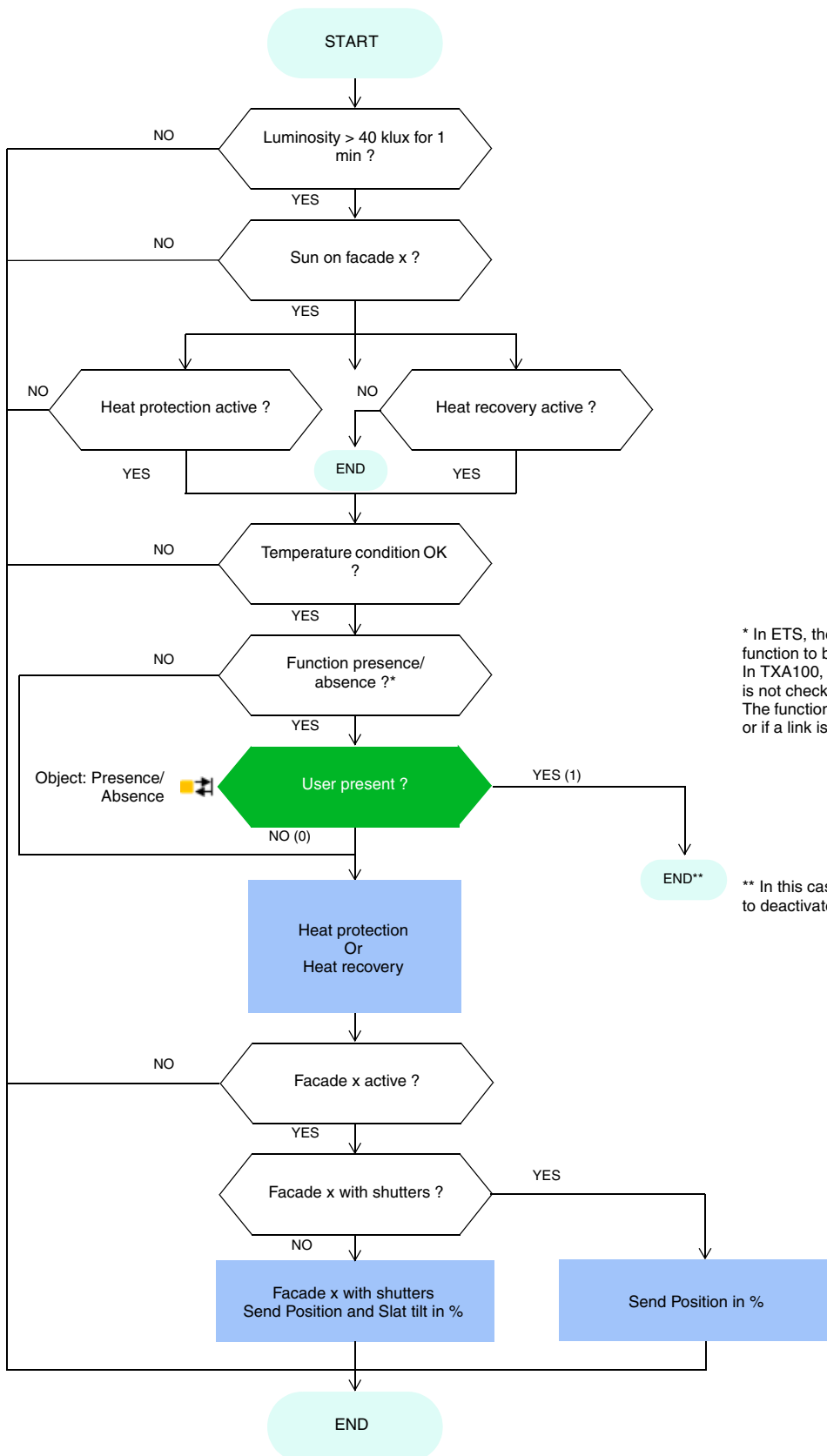

* In ETS, the group address must be linked for the function to be **active**.
 In TXA100, the function is **inactive** if export domovea is not checked and no link is established with an input. The function is **active** if the domovea export is checked or if a link is established with an input.

** In this case, the Presence/absence function is used to deactivate heat recovery and protection.

Operation without presence/absence function

Principle:

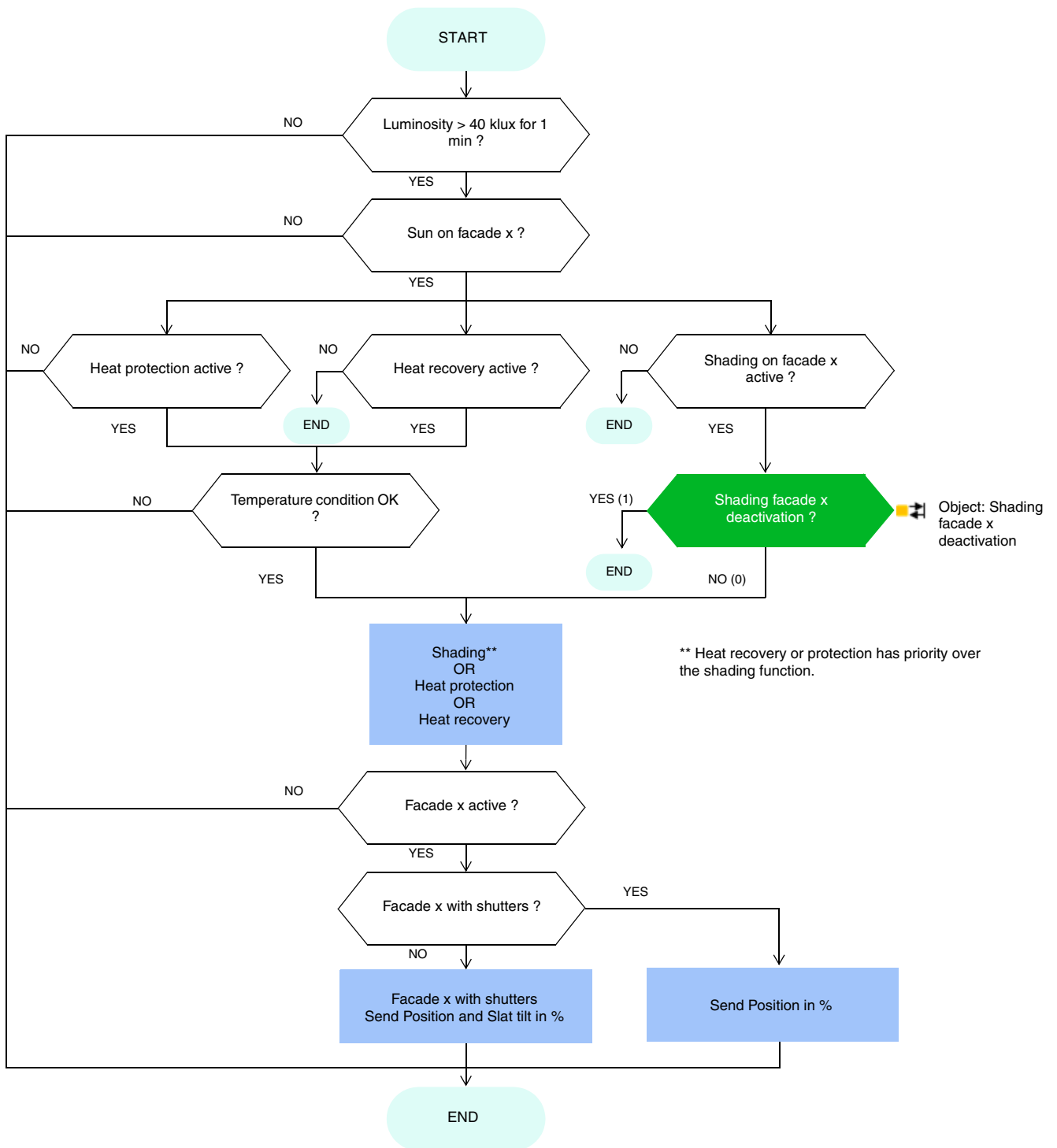

Operation without shading function and without presence/absence function

Principle:

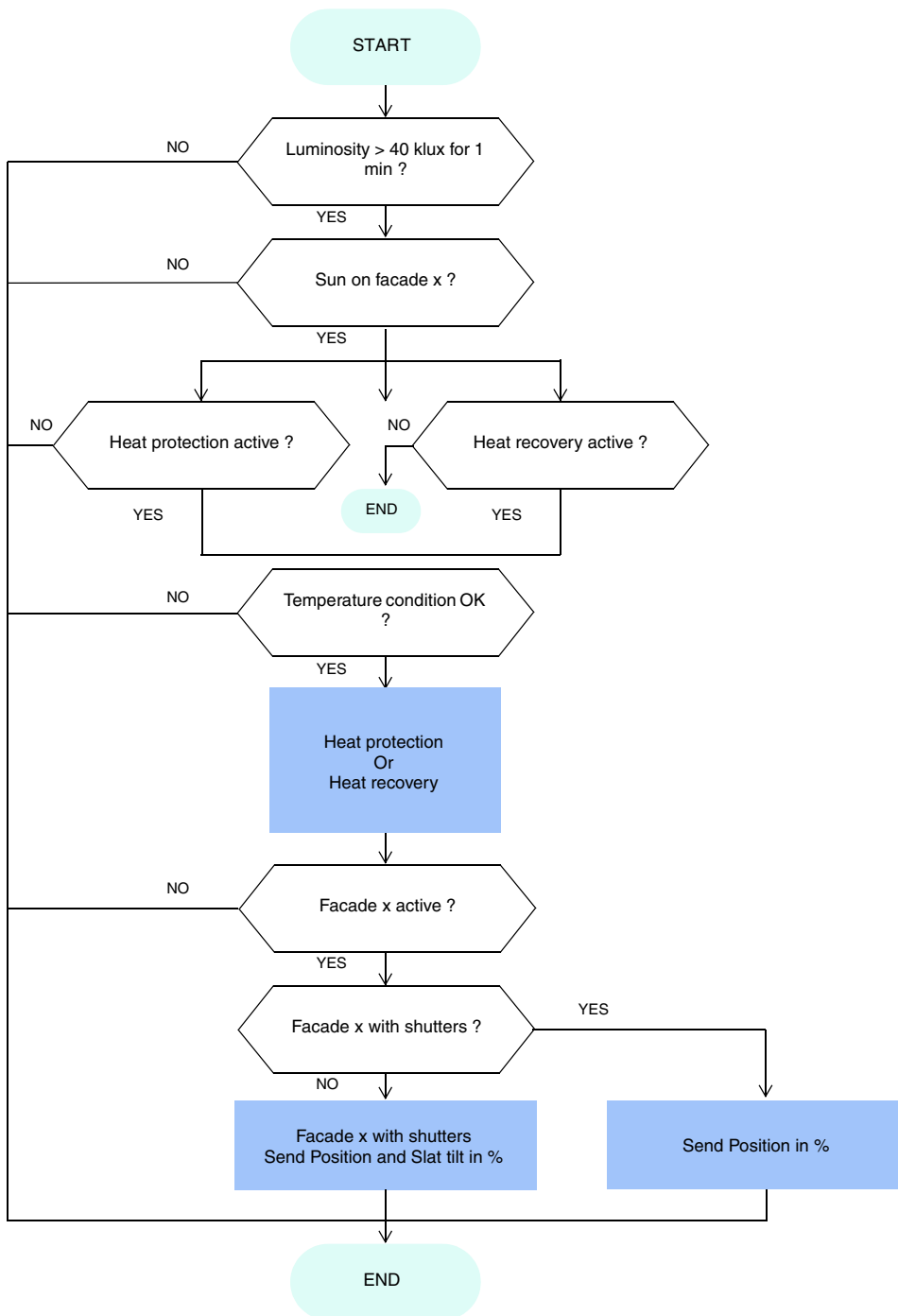

3. Programming by ETS

3.1 Parameters

3.1.1 General

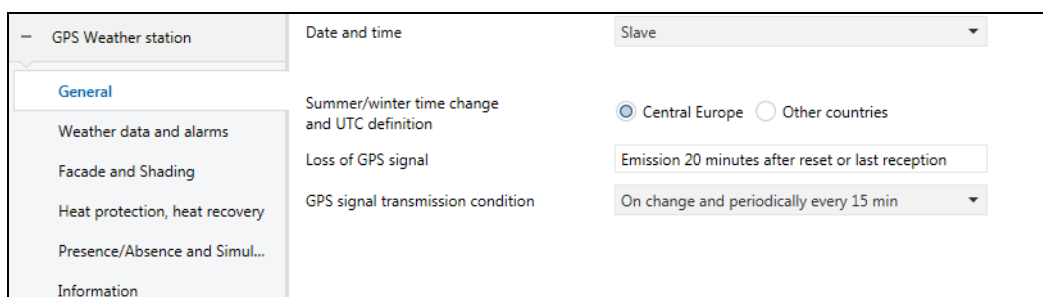

3.1.1.1 Date and time

The GPS module built into the device is able to send the date and time to the bus. When the weather station is set without restrictions, data is sent every 12 hours (fixed value) and during the time changes between summer and winter.

A single time must be managed for the different sub-systems. This time may come from different sources::

- domovea if connected to the internet
- weather station
- clock

If there are several time sources on the system, the priority is as follows:

- Internet
- GPS
- local time source (clock ...)

Parameter	Description	Value
Date and time	The device uses the time data from another device on the bus.	Slave*
	The device receives the time data through GPS and sends it to the KNX bus every 12 hours.	Master
	The device receives the time data through the GPS and does not send it to the KNX bus.	Autonomous

Date and time for Master

Communication objects:

- 12 - Date and time request - Input** (1 Bit - 1.017 DPT_Trigger)
- 13 - Date master - Output** (3 Byte - 11.001 DPT_Date)
- 14 - Time master - Output** (3 Byte - 10.001 DPT_TimeOfDay)
- 15 - Date and time master - Output** (8 Byte - 19.001 DPT_Date_Time)

In the first instance, the current date and time can be set via the ETS. The weather station works with this data until a valid GPS signal is received for the first time.

* Default value

Date and time for Slave

Communication objects:

- 9 - Date slave - Input** (3 Byte - 11.001 DPT_Date)
- 10 - Time slave - Input** (3 Byte - 10.001 DPT_TimeOfDay)
- 11 - Date and time slave - Input** (8 Byte - 19.001 DPT_Date_Time)
- 13 - Date master - Output** (3 Byte - 11.001 DPT_Date)
- 14 - Time master - Output** (3 Byte - 10.001 DPT_TimeOfDay)
- 15 - Date and time master - Output** (8 Byte - 19.001 DPT_Date_Time)
- 16 - Date and time request - Output** (1 Bit - 1.017 DPT_Trigger)

In slave mode, the weather station synchronizes itself to the date and time of the master system. However, it always operates with its own date and time when calculating the azimuth and elevation.

When the weather station does not receive date and time information over 2 successive tries (fixed value), it sends a request via the object (Date and time request). If there is no response, the weather station switches automatically to master mode. When the master device re-sends the date and time, the weather station returns to slave mode.

Date and time in Autonomous mode

The weather station operates with its own date and time to calculate the azimuth and elevation. No item is sent to or read on the KNX bus.

3.1.1.2 Time change

The switch-over for daylight saving time (summer/winter and winter/summer) is carried out automatically or using specific settings.

Parameter	Description	Value
Summer/winter time change and UTC definition	The time change is carried out automatically according to the Central Europe criteria.	Central Europe*
	The time change is carried out through specific settings according to the criteria in place in the country of installation. There are additional settings that allow configuration for other countries.	Other countries

* Default value

Switch-over for daylight saving time

Parameter	Description	Value
The First winter to summer time change	This setting determines the day of the week on which the time change will take place.	Sunday* Monday Tuesday Wednesday Thursday Friday Saturday Any day

Parameter	Description	Value
After	This setting determines at what time (day, month, hour, minute) the change will take place.	
Day		1... 25* ...31 day
Month		1... 3* ...12 month
Hours		0... 2* ...23 hours
Minutes		0* ...59 minutes

Example: If the time change takes place on the last Sunday of March at 2 am, select:

- First winter to summer time change **Sunday** after **24/03 at 2h 00m**.

Parameter	Description	Value
Summer time offset in minutes	This setting determines the offset value in minutes when the time changes (summer/winter; winter/summer).	60* minutes: 0 to 60 min

Summer/winter time change

Parameter	Description	Value
First summer/winter time change	This setting determines the day of the week on which the time change will take place.	Sunday* Monday Tuesday Wednesday Thursday Friday Saturday Any day

* Default value

Parameter	Description	Value
After	This setting determines at what time (day, month, hour, minute) the change will take place.	
Day		1... 25 *...31 day
Month		1... 3 *...12 month
Hours		0... 2 *...23 hours
Minutes		0 *...59 minutes

Example: If the time change takes place on the last Sunday of October at 3 am, select:

- First winter to summer time change **Sunday after 24/10 at 3h 00m.**

Parameter	Description	Value
UTC offset in minutes	This setting determines the value of the time difference (in minutes) in relation to Greenwich Mean Time.	60 * minutes: -720 to +780 min

3.1.1.3 GPS signal

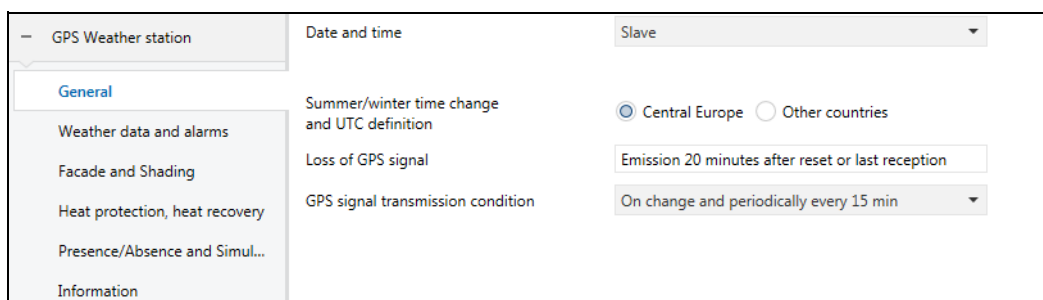

This function is used to signal the absence of the GPS signal at the weather station. This absence will be recognised 20 minutes (fixed value) after start-up or the last reception at the latest.

Parameter	Description	Value
Loss of GPS signal:	This parameter defines the duration of the delay before emission notifying loss of the GPS signal.	20 minute after start-up or last reception
GPS signal emission condition	The GPS signal object: Is not emitted Is emitted each time the value changes Is emitted each time the value changes or periodically every 15 minutes	Never On change On change and periodically every 15 min*

Operation of the **GPS signal** object:

- If the GPS signal is present, a telegram with a logical value 1 is emitted.
- If the GPS signal is not available, a telegram with a logical value 0 is emitted.

Communication objects: [17 - GPS signal - Output \(1 Bit - 1.011 DPT_State\)](#)

* Default value

3.1.2 Weather data and alarms

GPS Weather station		
General		
Weather data and alarms		
Facade and Shading		
Heat protection, heat recovery		
Presence/Absence and Simul...		
Information		
Outdoor temperature	Emission of value every 30 minutes	▼
	Emission on change: +/- 0,5°C	▼
Temperature alarm threshold	3	°C
	Hysteresis = 3°C	▼
Temperature alarm	1 if Value < Threshold / 0 if Value > Threshold...	▼
	Emission immediately and every 10 minutes	▼
Luminosity		
	Emission of value every 30 minutes	▼
	Emission on change: +/- 20%	▼
Day/night threshold	10	Lux
	Emission day if value > Threshold + 2 Lux duri...	▼
	Emission night if value < Threshold lux during...	▼
Day/night polarity	<input checked="" type="radio"/> Day = 0 / night = 1 <input type="radio"/> Day = 1 / night = 0	
Wind speed		
	Emission of value every 30 minutes	▼
	Emission on change: +/- 20%	▼
Wind alarm 1 threshold	15	Km/h
Wind alarm 2 threshold	30	Km/h
Wind alarm 3 threshold	45	Km/h
Wind alarm 1 to 3	1 if value > Threshold during 2 seconds	▼
	0 if Value < Threshold during 5 minutes	▼
	Emission immediately and every 10 minutes	▼
Rain alarm		
	Emission immediately and every 10 minutes	▼
	1 = it rains (no delay) / 0 = rain stop (5 minute...	▼

Note: All the greyed parameters of this tab are fixed and cannot be modified.

3.1.2.1 Temperature measurement

The outdoor temperature is mainly used for the heating, ventilation and air conditioning systems. It can also be used as a display on touch screens.

Parameter	Description	Value
Outdoor temperature	The temperature value is periodically sent every 30 minutes and at each change in temperature if it is greater than +/- 0.5°C from the last measurement.	Emission of value every 30 minutes Emission on change: +/- 0.5°C
Temperature alarm threshold	Used to define the temperature threshold value to activate the alarm.	-20 ... 3* ... 50°C
Temperature alarm	Used to define the polarity of the temperature alarm.	1 if Value > Threshold / 0 if Value < Threshold - Hyst. 0 if Value > Threshold / 1 if Value < Threshold - Hyst. 1 if Value < Threshold / 0 if Value > Threshold + Hyst.* 0 if Value < Threshold / 1 if Value > Threshold + Hyst.

In order to validate alarm activation, the measured value must be lower than or higher than the threshold value **for 5 minutes**. To deactivate the alarm, the measured value must be lower than or higher than the threshold value plus or minus the hysteresis value set at 3°C.

Example of the frost alarm:

- Temperature alarm threshold: 3°C (Default value)
- Temperature alarm: 1 if Value < Threshold / 0 if Value > Threshold + Hyst. (Default value)
- The temperature alarm is active (bit = 1) if the measured value is lower than the threshold value (3°C) for 5 minutes. It will immediately be transmitted and every 10 minutes thereafter.
- The temperature alarm is inactive (bit = 0) if the measured value rises above 5°C. It will immediately be transmitted and every 10 minutes thereafter.

Communication objects: **0 - Outdoor temperature - Output (2 Byte - 9.001 DPT_Value_Temp)**
 8 - Temperature alarm - Output (1 Bit - 1.005 DPT_Alarm)

* Default value

3.1.2.2 Luminosity

The outdoor luminosity is mainly used for lighting control systems and shading management, taking the position of the sun into account. It can also be used as a display on touch screens.

Parameter	Description	Value
Luminosity	The luminosity value is periodically sent every 30 minutes and at each change if the variation is greater than 20 % compared to the last measurement.	Emission of value every 30 minutes Emission on change: +/- 20 %
Day/night threshold	Used to define the luminosity threshold value for the detection of day or night.	5 ... 10* ... 50 lux
Day/night polarity	used to define the polarity of the day/night object.	Day = 0 / night = 1* Day = 1 / night = 0

An emission delay is necessary to avoid having more than one day/night change per day. The information is sent 2 times every 24 hours (switching from day to night and night to day).

Example of day/night information operation (with default values):

- The "Day" information is activated (bit = 0) if the value measured is greater than the threshold value + hysteresis (12 Lux) for more than one minute (fixed value).
- The "Night" information is activated (bit = 1) if the value measured is less than the threshold value (10 Lux) for one minute.

Communication objects: **2 - Luminosity - Output** (2 Byte - 9.004 DPT_Value_Lux)

3 - Day/night - Output (1 Bit - 1.011 DPT_State)

* Default value

3.1.2.3 Wind speed

The wind speed value is mainly used to secure shutters and blinds. It can also be used as a display on touch screens.

Parameter	Description	Value
Wind speed	The wind speed value is periodically sent every 30 minutes and at each change if the variation is greater than 20 % compared to the last measurement.	Emission of value every 30 minutes Emission on change: +/- 20 %
Wind alarm 1 threshold	Used to define the wind speed threshold value for wind alarm 1.	10 ... 15* ... 100 km/h
Wind alarm 2 threshold	Used to define the wind speed threshold value for wind alarm 2.	10 ... 30* ... 100 km/h
Wind alarm 3 threshold	Used to define the wind speed threshold value for wind alarm 3.	10 ... 45* ... 100 km/h
Wind alarm 1 to 3	The wind alarm 1 to 3 (1 bit) can be used directly by the shutter/blind output modules (one alarm per shutter/blind).	1 if value > Threshold during 2 seconds 0 if Value < Threshold during 5 minutes Emission immediately and every 10 minutes

A communication object is available for each of the three alarms.

The wind alarm (1 to 3) operates as follows:

- The wind alarm is activated (bit = 1) if the value measured is greater than the threshold value for more than 2 seconds. It will immediately be transmitted and every 10 minutes thereafter.
- The wind alarm is deactivated (bit = 0) if the value measured is less than the threshold value for more than 5 minutes. It will immediately be transmitted and every 10 minutes thereafter.

Communication objects: **1 - Wind speed - Output** (2 Byte - 9.005 DPT_Value_Wsp)
 4 - Wind alarm 1 - Output (1 Bit - 1.005 DPT_Alarm)
 5 - Wind alarm 2 - Output (1 Bit - 1.005 DPT_Alarm)
 6 - Wind alarm 3 - Output (1 Bit - 1.005 DPT_Alarm)

3.1.2.4 Rain alarm

The rain alarm mainly controls the opening and closing of canopies or skylights. It can also be used as a display on touch screens.

Parameter	Description	Value
Rain alarm	The rain alarm (1 bit) can be used directly by the shutter/blind output modules.	Emission every 10 minutes

The rain alarm operates as follows:

- The rain alarm is activated (bit = 1) when rain is detected. It will immediately be transmitted and every 10 minutes thereafter.
- The rain alarm is deactivated (bit = 0) after a period of 5 minutes after rain has stopped. It will be transmitted every 10 minutes.

Communication objects: **7 - Rain alarm - Output** (1 Bit - 1.005 DPT_Alarm)

* Default value

3.1.3 Façades and shading

The aim of the shading function is to provide further comfort for people in the room by preventing glare from the sun. To simplify the use and configuration of the weather station, we recommend working with façades that are fitted only with shutters or only with blinds.

The shading control options (blind or louver position and slat tilt positions) are associated with façades.

Facade controls

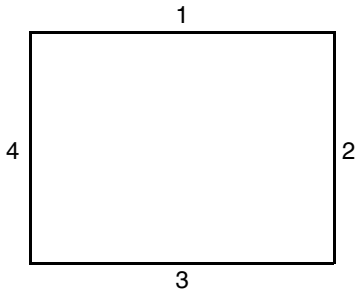

The majority of buildings have 4 façades. Creating a separate command for the sun protection of each facade is recommended.

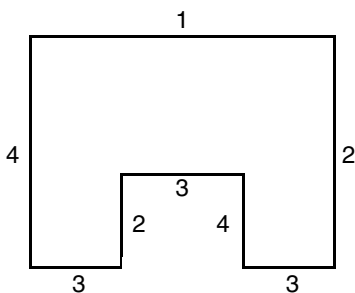

For U shaped buildings, only 4 façades must be controlled separately, insofar as several are facing the same direction.

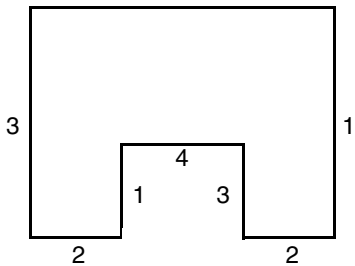

To manage shading on a facade with both blinds and shutters, two façades must be registered: one for blinds and one for shutters. Here, facade 2 is for shutters and facade 4 is for blinds.

Facade direction

The direction of each facade must be defined in the setup for the shading function to operate correctly.

- Defining the direction of each facade used.

Example 1:

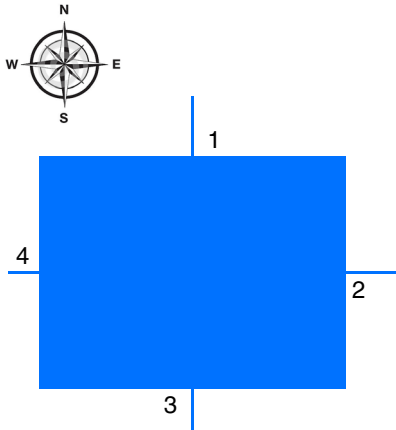

Direction:

- Facade 1: $N = 0^\circ$
- Facade 2: $E = 90^\circ$
- Facade 3: $S = 180^\circ$
- Facade 4: $W = 270^\circ$

Example 2:

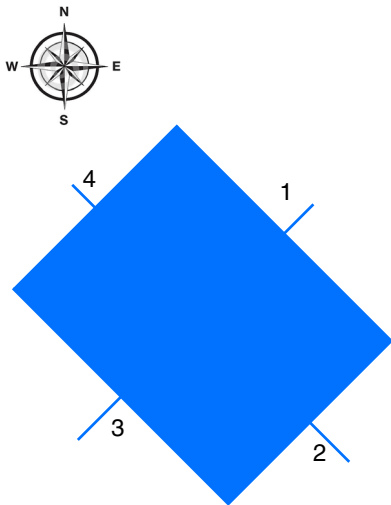

Direction:

- Facade 1: $NE = 45^\circ$
- Facade 2: $SE = 135^\circ$
- Facade 3: $SW = 225^\circ$
- Facade 4: $NW = 315^\circ$

GPS Weather station	Facade 1	Position tracking for shutters
General	Facade orientation in °	S = 180°
Weather data and alarms	Shading facade 1	<input type="radio"/> Not active <input checked="" type="radio"/> Active
Facade and Shading	Shading position max. (20 - 80%)	80%
Heat protection, heat recovery	Facade 2	Not active
Presence/Absence and Simul...	Facade 3	Not active
Information	Facade 4	Not active

Parameter	Description	Value
Facade x	<p>The facade is not used for position tracking.</p> <p>The facade is used for position tracking the rolling shutters only.</p> <p>The facade is used for position tracking the blinds (position and tilt). The blind tilting control varies by an angle of between 0 and 180°.</p> <p>The facade is used for position tracking the blinds (position and tilt). The blind tilting control varies by an angle of between 90 and 180°.</p>	<p>Not active*</p> <p>Position tracking for shutters</p> <p>Position and slat tracking for blinds 0 to 180°</p> <p>Position and slat tracking for blinds 90 to 180°</p>
Facade orientation in °	This setting defines the direction of the facade according to the compass points.	<p>N = 0°</p> <p>NE = 45°</p> <p>E = 90°</p> <p>SE = 135°</p> <p>S = 180°</p> <p>SW = 225°</p> <p>W = 270°</p> <p>NW = 315°</p> <p>All = 360°</p>
Shading facade x	<p>The shading function is not validated on this facade.</p> <p>The shading function is validated on this facade.</p>	<p>Not active*</p> <p>Active</p>

Note: To manage a glazed roof or partially glazed roof, the roof must be declared as one of the facades with the setting (All = 360°).

Note: Operation is only provided for blinds with horizontal slats or rolling shutters.

* Default value

Valid zones according to the horizontal position of the sun:

Parameter	Direction	Valid zone
N = 0°	North	270° to 90°
NE = 45°	North - East	315° to 135°
E = 90°	East	0° to 180°
SE = 135°	South - East	45° to 225°
S = 180°	South	90° to 270°
SW = 225°	South - West	135° to 315°
W = 270°	West	180° to 360°
NW = 315°	North - West	225° to 45°
All = 360°		0° to 360°

The valid zone according to the vertical position of the sun is 0° to 90°

Shading concept for rolling shutters and slat blinds:

With shading tracking, the sun protection is not fully lowered, thus allowing the sun to penetrate the room. In this way, users at the bottom of the window can see out and plants on the windowsill will receive sunshine.

Note: Shading tracking can only be used when the sun protection is lowered from top to bottom (such as shutters, textile sun protection or blinds with horizontal slats). This function is not usable for a sun protection that is pulled from one side to the other or pulled in front of a window from both sides.

Shading with roller shutters

Shading is automatically controlled if the shading conditions on the relevant facade are fulfilled: luminosity threshold > 40 klux and sun on the facade. The shading thus moves in line with the path of the sun. It starts with a configurable minimum shutter closure value and maximum closure value of between 20 and 80 %. Full automatic closure can only be obtained if the heat protection function is activated.

Example of 80% maximum closure (default value):

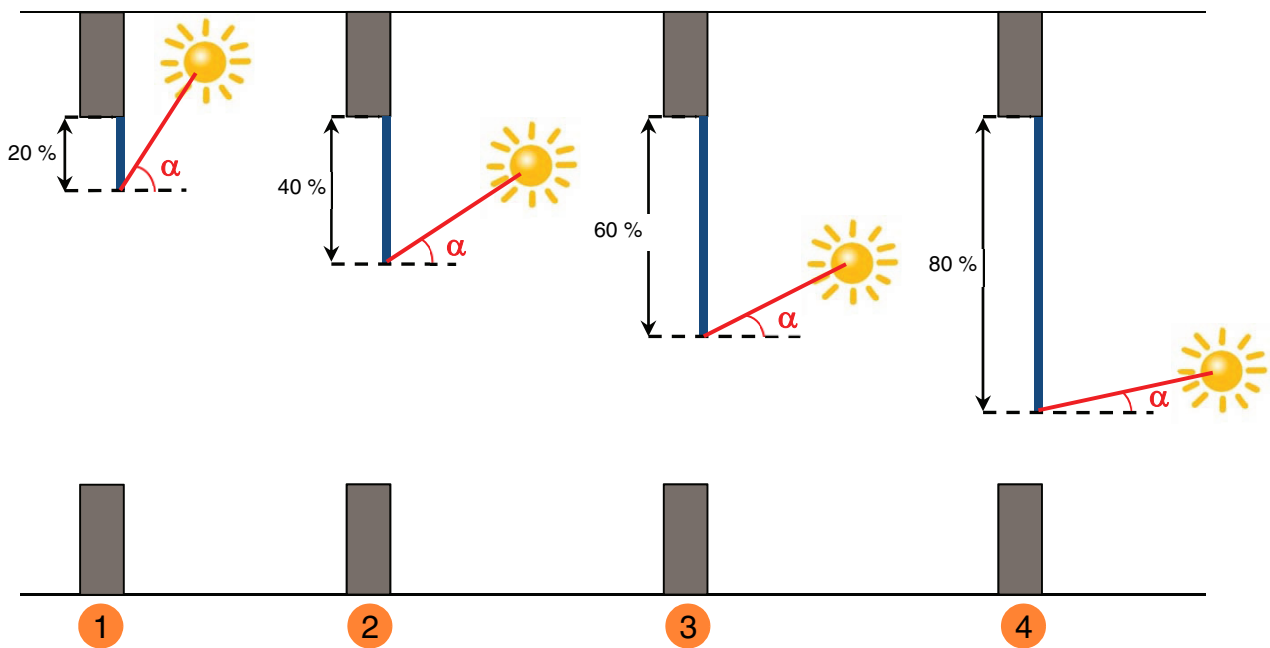

Example	Shutter position	Sun position - Angle α between
1	20%	46° ... 90°
2	40%	31° ... 45°
3	60%	16° ... 30°
4	80%	0° ... 15°

Example with maximum closure set at 40%:

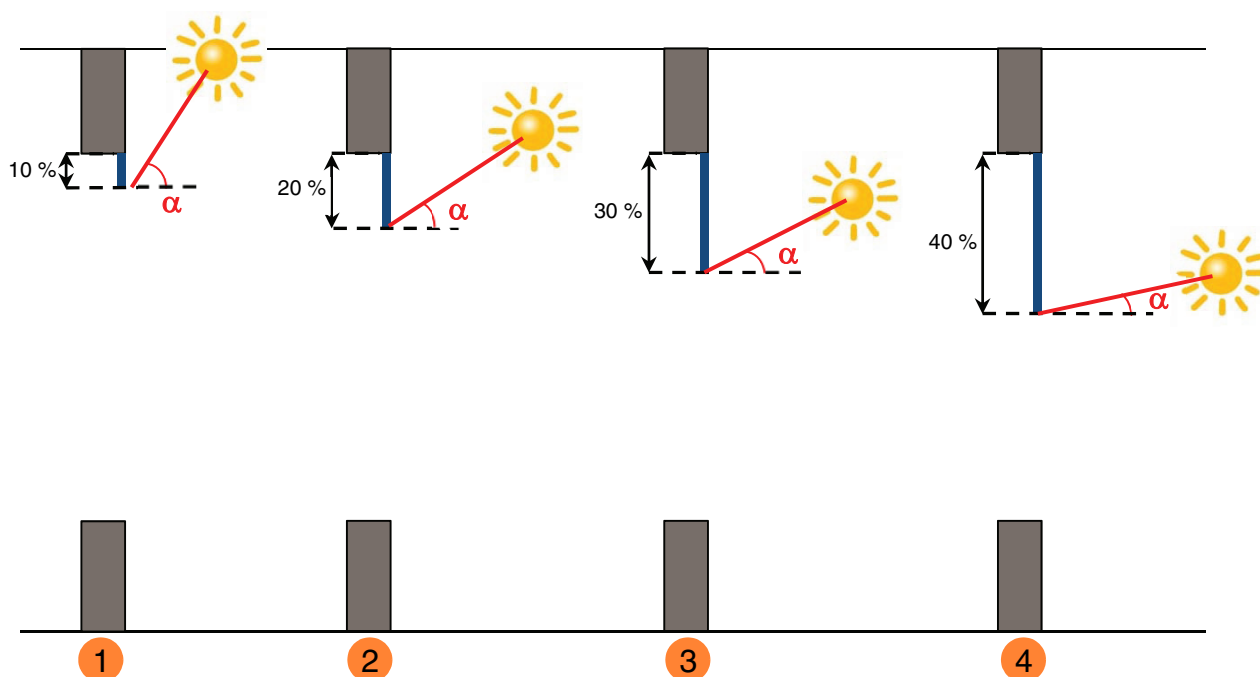

Example	Shutter position	Sun position - Angle α between
1	10%	46° ... 90°
2	20%	31° ... 45°
3	30%	16° ... 30°
4	40%	0° ... 15°

Sun protection operation for shutters:

If the luminosity level is sufficient (more than 40 Klux for more than one minute) **and** the sun is shining on the facade:

- The shutter is positioned in line with the path of the sun between x% closure and the maximum shading position defined by the configuration (20 to 80 %).

If the luminosity level is insufficient (less than 32 Klux for more than 15 minutes) **or** the sun is not shining on the facade:

- The shutter is positioned at a fixed value of 0 %.

Facade 1	Position tracking for shutters
Facade orientation in °	S = 180°
Shading facade 1	<input type="radio"/> Not active <input checked="" type="radio"/> Active
Shading position max. (20 - 80%)	80%

Parameter	Description	Value
Shading position max. (20 - 80 %)	This setting defines the maximum permitted closure for automatic shading control.	20... 80 %*

Shading with slat blinds

During slat adjustment, the horizontal slats of the blinds are not fully closed; rather they are matched to the sun condition and set automatically in such a way that the sun cannot shine directly into the room.

However diffuse daylight can enter the room between the slats and so provide glare-free room lighting. Slat adjustment of an external blind prevents the entry of heat from sunshine into the room and, at the same time, reduces the cost of electricity for room lighting.

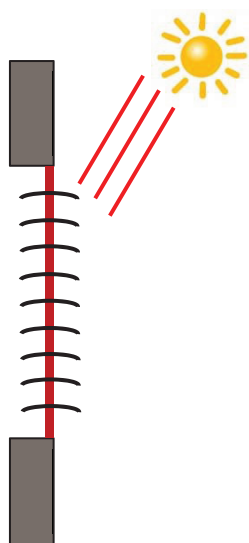

Position: 100 %
Tilt tracking: 50 %

Sun protection at high sun elevations

Shading is automatically controlled if the shading conditions on the relevant facade are fulfilled: luminosity threshold > 40 klux and sun on the facade. To limit the number of trips, the shading starts by fully lowering the blinds following the direction of the slats at 50 %.

The low position will be maintained as long as the shading function is activated, and adjustments are made simply by orienting the slats depending on the position of the sun.

The slats are positioned almost horizontally, so that the sun does not directly penetrate the room.

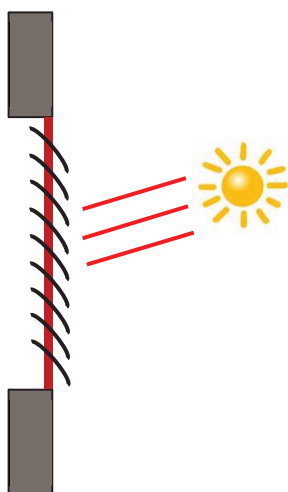

Position: 100 %
Tilt tracking: 80 %

Sun protection at medium sun elevations

The low position is maintained and the slats are re-closed a little more to prevent sunlight from directly entering the room.

Diffuse daylight, however, can still continue to enter and so provide lighting for the room (daylight use).

Sun protection at low sun elevations

The slats are automatically closed to an extent where the sun cannot shine directly into the room.

* Default value

Shading operation for blinds:

If the luminosity level is sufficient (more than 40 Klux for more than one minute) **and** the sun is shining on the facade:

- The blind is positioned at the fixed value of 100 % (lower position).
- The blind is tilted at a value calculated by the weather station depending on the position of the sun.

If the luminosity level is insufficient (less than 32 klux for more than 10 minutes):

- The blind remains in the 100 % lowered position.
- The blind tilts the slats horizontally (50 % value).

If at the end of 30 minutes, the luminosity level is still insufficient (less than 32 Klux for more than 10 minutes) **or** the sun is not shining on the facade:

- The blind is positioned at the fixed value of 0 %.
- The blind tilts the slats at a fixed value of 0 %.

Facade 1	Position and slat tracking for blinds 0° to 180°
Facade orientation in °	S = 180°
Shading facade 1	<input type="radio"/> Not active <input checked="" type="radio"/> Active
Driving position for shading with slats	Position down 100%

Position and slat tracking for blinds 0 to 180°: The blind tilting control varies by an angle of between 0 and 180°.

Position and slat tracking for blinds 90 to 180°: The blind tilting control varies by an angle of between 90 and 180°.

Parameter	Description	Value
Driving position for shading with slats	This setting indicates that the blinds remain in the lowered position while the shading function is activated. This limits positioning movements, so shading is carried out only by orienting the slats. The value of this setting is fixed.	Position down 100 %*

The **facade x shading deactivation** object disables the shading for each facade. The deactivation control can be in the form of a supervision system or push button.

The deactivation control operates as follows:

- If the **facade x shading deactivation** object receives the value 0, sun protection of the relevant facade is authorised.
- If the **facade x shading deactivation** object receives the value 1, sun protection of the relevant facade is not authorised.

The **facade x shading deactivation status** object transmits the **facade x shading deactivation** object status. It is emitted each time a status change occurs.

Communication objects (Facade 1):

18 - Sun protection facade 1 position % - Output (1 Byte - 5.001 DPT_Scaling)

19 - Sun protection facade 1 slat angle % - Output (1 Byte - 5.001 DPT_Scaling)

20 - Shading facade 1 deactivation - Input (1 Bit - 1.003 DPT_Enable)

21 - Shading deactivation status facade 1 - Output (1 Bit - 1.003 DPT_Enable)

* Default value

Communication objects (Facade 2):

- 22 - Sun protection facade 2 position % - Output (1 Byte - 5.001 DPT_Scaling)
- 23 - Sun protection facade 2 slat angle % - Output (1 Byte - 5.001 DPT_Scaling)
- 24 - Shading facade 2 deactivation - Input (1 Bit - 1.003 DPT_Enable)
- 25 - Shading deactivation status facade 2 - Output (1 Bit - 1.003 DPT_Enable)

Communication objects (Facade 3):

- 26 - Sun protection facade 3 position % - Output (1 Byte - 5.001 DPT_Scaling)
- 27 - Sun protection facade 3 slat angle % - Output (1 Byte - 5.001 DPT_Scaling)
- 28 - Shading facade 3 deactivation - Input (1 Bit - 1.003 DPT_Enable)
- 29 - Shading deactivation status facade 3 - Output (1 Bit - 1.003 DPT_Enable)

Communication objects (Facade 4):

- 30 - Sun protection facade 4 position % - Output (1 Byte - 5.001 DPT_Scaling)
- 31 - Sun protection facade 4 slat angle % - Output (1 Byte - 5.001 DPT_Scaling)
- 32 - Shading facade 4 deactivation - Input (1 Bit - 1.003 DPT_Enable)
- 33 - Shading deactivation status facade 4 - Output (1 Bit - 1.003 DPT_Enable)

Fixed values per facade:

Parameter	Value
Luminosity threshold	40 Klux
Hysteresis of the luminosity threshold	- 8 Klux
Tilting in % after a slat control of 50 %	50 % (90°)
Tilting in % after a slat control of 100 %	100 % (180°)

3.1.4 Heat protection, heat recovery

This function is used to alter the indoor temperature according to the sun's rays and the season. In summer, the heat protection allows for the blinds to be positioned so as to limit warming of the room.

In winter or mid-season, heat recovery allows the blinds to be positioned so as to reheat the room using sunlight, thus benefiting from a free heat source.

These two functions result in the full opening or closing of shutters or blinds. Using these functions is recommended when rooms are empty.

The screenshot shows a control panel for a 'GPS Weather station'. The left sidebar contains a menu with options: General, Weather data and alarms, Facade and Shading, Heat protection, heat recov..., Presence/Absence and Simul..., and Information. The main area is titled 'The object presence/absence allows or denies heat protection or heat recovery for all facades'. It is divided into two sections: 'Heat protection' and 'Heat recovery'. Each section has a 'Use of ... automatic control' toggle (set to 'Yes'), 'Conditions' (Sun on the facade, Luminosity > 40 klux during more than 1 mi..., Outdoor T° > Threshold or (only facade 1) in...), a 'T° threshold' slider (30°C for protection, 12°C for recovery), and 'Deactivation' conditions (Threshold -6°C and (only facade 1) indoor T° <... for protection, Threshold +10°C or (only facade 1) indoor T° >... for recovery).

Heat protection

Heat protection is used to prevent the room from overheating and to limit the use of the air conditioning system.

It depends on:

- Luminosity (more than 40 klux)
- the position of the sun on the facade
- the outdoor temperature on all of the facades
- or the indoor temperature for facade 1 only

Heat protection also depends on the Presence/Absence information if this object is used and linked (See chapter 3.1.5).

If the luminosity level is sufficient (more than 40 Klux for more than one minute) **and** the sun is shining on the facade **and** the outdoor temperature is greater than 30°C **or** the indoor temperature is greater than 26°C on the facade 1:

- The heat protection is activated. The shutters and blinds close completely. This function is prioritized on the shading control.

If the luminosity level is insufficient (less than 32 Klux for over 10 minutes) **or** the sun is not present on the facade **or** the outdoor temperature is lower than 24°C (= outdoor setpoint T° for heat protection - 6°C) **and** the indoor temperature is lower than 22°C for facade 1 for more than 15 minutes:

- The heat protection is deactivated. The shutters and blinds remain in position.

*Note: If the **Indoor temperature for facade 1** object does not receive a value, the indoor temperature is ignored and only the outdoor temperature is taken into account.*

Parameter	Description	Value
Use of heat protection automatic control	The heat protection automatic control is: Not active Active	No* Yes

Parameter	Description	Value
Use of heat protection automatic control	This setting defines the conditions so that the heat protection is activated. The value of this setting is fixed.	Sun on the facade Luminosity > 40 klux for over 1 minutes Outdoor T° > Threshold or (only facade 1) indoor T° > 26°C*
Heat protection T° threshold	Used to define the outdoor temperature threshold value for heat protection.	28 ... 30* ... 36°C
Heat protection deactivation	This parameter defines the conditions for heat protection to be inactive. The value of this setting is fixed.	Threshold -6°C and (only facade 1) indoor T° < 22°C

The **Heat protection status** object is used to indicate that the heat protection function is active (e.g. very sunny day in summer).

Object value:

- If the heat protection function is activated on at least one facade, a telegram with a logical value 1 is emitted.
- If the heat protection function is deactivated on all the facades, a telegram with a logical value 0 is emitted.

Communication objects:

[36 - Heat protection status- Output \(1 Bit - 1.011 DPT_State\)](#)

[38 - Indoor temperature for facade 1 - Input \(2 Byte - 9.001 DPT_Value_Temp\)](#)

Heat recovery

To save energy, the heat recovery system contributes to heating up the room by using the sun's energy.

It depends on:

- luminosity
- the position of the sun on the facade
- the outdoor temperature on all of the facades
- or the indoor temperature for facade 1 only

Heat protection also depends on the Presence/Absence information if this object is used and linked (See chapter 3.1.5).

* Default value

Heat recovery operation: (With the default values)

If the luminosity level is sufficient (more than 40 Klux for more than one minute) **and** the sun is shining on the facade **and** the outdoor temperature is less than 12°C **and** the indoor temperature is less than 22°C for facade 1:

- Heat recovery is activated. The shutters and blinds open completely.
- **Warning:** This function should not be used for openings that are part of the anti-intrusion system.

If the luminosity level is insufficient (less than 32 Klux for more than 15 minutes) **or** the sun is no longer present on the facade **or** the outdoor temperature is higher than 22°C (= outdoor setpoint T° for heat protection + 10°C) **and** the indoor temperature is higher than 26°C for facade 1 for more than 15 minutes:

- Heat recovery is disabled. The shutters and blinds close completely.

*Note: If the **Indoor temperature for facade 1** object does not receive a value, the indoor temperature is ignored and only the outdoor temperature is taken into account.*

Parameter	Description	Value
Use of heat recovery automatic control	Automatic control of heat recovery is: Not active Active	No* Yes

Parameter	Description	Value
Heat recovery conditions	This parameter defines the conditions for heat recovery to be activated. The value of this setting is fixed.	Sun on the facade Luminosity > 40 klux for over 1 minutes Outdoor T° > Threshold or (facade 1) indoor T° < 22°C*
Heat recovery T° threshold	Used to define the outdoor temperature threshold for heat recovery.	10 ... 12* ... 15°C
Heat recovery deactivation	This parameter defines the conditions for heat recovery to be inactive. The value of this setting is fixed.	Threshold +10°C and (facade 1) indoor T° > 26°C

The **Heat recovery status** object is used to indicate that the heat recovery function is active (e.g. very sunny day in winter).

Object value:

- if the heat recovery function is activated on at least one facade, a telegram with a logical value 1 is emitted.
- if the heat recovery function is deactivated on all the facades, a telegram with a logical value 0 is emitted.

Communication objects:

37 - Heat recovery status- Output (1 Bit - 1.011 DPT_State)

38 - Indoor temperature for facade 1 - Input (2 Byte - 9.001 DPT_Value_Temp)

* Default value

The table below summarises the temperature conditions for heat recovery and protection:

Automatic control		Temperature conditions		Result if all the conditions are met
		Outdoor temperature	Indoor temperature (if used)	
Heat protection	Activation	Outdoor temperature > threshold value with an adjustable threshold value of 28 to 36°C (Default value = 30°C)	Or Indoor temperature > 26°C	Closure of the shutters/blinds
	Deactivation	Outdoor temperature < threshold value - 6°C	And Indoor temperature < 22°C	Position of the shutters/blinds maintained or switch to shading function if selected and if all the conditions are met
Heat recovery	Activation	Outdoor temperature < threshold value with an adjustable threshold value of 10 to 15°C (Default value = 12°C)	And Indoor temperature < 22°C	Opening of the shutters/blinds
	Deactivation	Outdoor temperature > threshold value + 10°C	Or Indoor temperature > 26°C	Closure of the shutters/blinds or switch to shading function if selected and if all the conditions are met

3.1.5 Presence/Absence

This function is used to signal the presence or absence of the user to manage activation or deactivation of shading per façade, heat protection or heat recovery.

Parameter	Description	Value
Use of Presence/Absence object	<p>The Presence/Absence automatic control is:</p> <p>Not active</p> <p>Active</p> <p>If there are no reliable means able to deliver the Presence/Absence information, this parameter can be inhibited.</p>	<p>No</p> <p>Yes*</p>

Presence/absence operation

When the user is in absence mode:

- No shading function is permitted.
- The heat recovery or protection function is active if it is authorised and if all the required conditions are met.
- The shutters or blinds close at the end of heat recovery.
- The shutters or blinds remain closed at the end of heat protection.

When the user is in presence mode:

- The shading function is active if it is authorised and all the required conditions are met.
- The heat recovery or protection function is not permitted.

The presence/absence information can come from different products such as:

- Presence detectors.
- Daily, weekly, monthly or astronomic clocks.
- Alarm systems (active or inactive).

Object value:

- If the **Présence/absence** object receives the value 0, this means that the user is absent.
- If the **Présence/absence** object receives the value 1, this means that the user is present.

The **Présence/absence status** object transmits the status of the **présence/absence** object.

Object value:

- If the user is absent, a telegram with a logical value 0 is emitted.
- If the user is present, a telegram with a logical value 1 is emitted.

Communication objects:

[34 - Presence/Absence - Input \(1 Bit - 1.003 DPT_Enable\)](#)

[35 - Presence/Absence status - Output \(1 Bit - 1.003 DPT_Enable\)](#)

* Default value

3.1.6 Simulation

This function enables the installer to test the parameters of the weather station independently of the weather conditions. For this purpose the installer has several communication objects allowing weather conditions to be simulated (temperature, wind speed, luminosity, rain) the GPS coordinates, the date and time.

GPS Weather station	Use of Presence/Absence object	<input type="radio"/> No <input checked="" type="radio"/> Yes
General	Use of alarm levels simulation	<input checked="" type="radio"/> No <input type="radio"/> Yes
Weather data and alarms	Use of shading, heat protection or heat recovery simulation	<input checked="" type="radio"/> No <input type="radio"/> Yes
Facade and Shading		
Heat protection, heat recovery		
Presence/Absence and Simu...		
Information		

Parameter	Description	Value
Use of alarm levels simulation	Simulation of alarm levels is:	
	Not active	No*
	Active	Yes

Activating this parameter allows the following objects to be displayed:

[39 - Wind speed simulation - Input \(2 Byte - 9.005 DPT_Value_Wsp\)](#)

[40 - Luminosity simulation - Input \(2 Byte - 9.004 DPT_Value_Lux\)](#)

[41 - Outdoor T° simulation - Input \(2 Byte - 9.001 DPT_Value_Temp\)](#)

[42 - Rain simulation \(1=rain\) - Input \(1 Bit - 1.003 DPT_Enable\)](#)

Parameter	Description	Value
Use of shading, heat protection or heat recovery simulation	Simulation of shading, heat recovery or protection is:	
	Not active	No*
	Active	Yes

* Default value

Activating this parameter allows the following objects to be displayed:

- 43 - Indoor T° simulation - Input (2 Byte - 9.001 DPT_Value_Temp)
- 44 - Shading facade 1 deactivation simulation - Input (1 Bit - 1.003 DPT_Enable)
- 45 - Shading facade 2 deactivation simulation - Input (1 Bit - 1.003 DPT_Enable)
- 46 - Shading facade 3 deactivation simulation - Input (1 Bit - 1.003 DPT_Enable)
- 47 - Shading facade 4 deactivation simulation - Input (1 Bit - 1.003 DPT_Enable)
- 48 - Presence/Absence simulation - Input (1 Bit - 1.003 DPT_Enable)
- 49 - Date simulation - Input (3 Byte - 11.001 DPT_Date)
- 50 - Time simulation - Input (3 Byte - 10.001 DPT_TimeOfDay)
- 51 - Time and date simulation - Input (8 Byte - 19.001 DPT_Date_Time)
- 52 - Location: Northern latitude in ° - Input (4 Byte - 14.007 DPT_Angle(degree))
- 53 - Location: Eastern longitude in ° - Input (4 Byte - 14.007 DPT_Angle(degree))
- 54 - Location: Northern latitude + Eastern longitude in ° - Input (8 Byte - 255.001)

Note: The simulation values entered in ETS for the various simulated magnitudes must comply with the operating ranges of the weather station.

Communication objects:

- 55 - Simulation activation - Input (1 Bit - 1.003 DPT_Enable)
- 56 - Simulation value reset - Input (1 Bit - 1.003 DPT_Enable)
- 57 - Simulation activation status - Output (1 Bit - 1.003 DPT_Enable)

Activating simulation

The values of the objects above can be sent to the weather station to prepare the simulation. The simulation is only launched when the **Simulation activation** object receives the value 1. The **Simulation activation status** object is emitted after each change (1 = simulation active, 0 = simulation inactive).

During the simulation, the system operates as follows:

- The alarm levels and the day/night information are immediately taken into account.
- The shutter/blind output modules controlled by the weather station must be in normal mode (no lock-up, no alarm, no priority, etc.)
- The shutter/blind output modules follow the commands from the simulation for the facades in question.
- If the simulation values for the date and time are sent separately (2 objects), the delay between sending them must not exceed 10 seconds to be taken into account.
- The longitude and latitude simulation values defined by the user take priority over the GPS positioning data. If the user does not send any value, the GPD data is used.

Note: If, during the simulation, the weather station is indoors, GPS reception may not operate. In this case, it is preferable to send the longitude and latitude data using communication objects.

End of the simulation

The simulation is stopped when the **Simulation activation** object receives the value 0. The effect of this is to erase all the simulation values.

At the end of the simulation, the system operates as follows:

- The shutter/blind output modules follow the normal commands for the facades in question. All the simulation commands are ignored.
- The values of the objects before the simulation are once more applied.

Note: the simulation function will be automatically stopped after one hour if no simulation control is received.

3.2 Communication objects

	Number	Name	Function of the object	Length	C	R	W	T
	0	Outdoor temperature	Output	2 byte	C	R	-	T
	1	Wind speed	Output	2 byte	C	R	-	T
	2	Luminosity	Output	2 byte	C	R	-	T
	3	Day/night	Output	1 bit	C	R	-	T
	4	Wind alarm 1	Output	1 bit	C	R	-	T
	5	Wind alarm 2	Output	1 bit	C	R	-	T
	6	Wind alarm 3	Output	1 bit	C	R	-	T
	7	Rain alarm	Output	1 bit	C	R	-	T
	8	Temperature alarm	Output	1 bit	C	R	-	T
	9	Date slave	Input	3 byte	C	-	W	-
	10	Time slave	Input	3 byte	C	-	W	-
	11	Date and time slave	Input	8 byte	C	-	W	T
	12	Date and time request	Input	1 bit	C	-	W	-
	13	Date master	Output	3 byte	C	R	-	T
	14	Time master	Output	3 byte	C	R	-	T
	15	Date and time master	Output	8 byte	C	R	-	T
	16	Date and time request	Output	1 bit	C	-	-	T
	17	GPS signal	Output	1 bit	C	R	-	T
	18	Sun protection facade 1 position %	Output	1 byte	C	R	-	T
	19	Sun protection facade 1 slat angle %	Output	1 byte	C	R	-	T
	20	Shading facade 1 deactivation	Input	1 bit	C	-	W	-
	21	Shading deactivation status facade 1	Output	1 bit	C	R	-	T
	22	Sun protection facade 2 position %	Output	1 byte	C	R	-	T
	23	Sun protection facade 2 slat angle %	Output	1 byte	C	R	-	T
	24	Shading facade 2 deactivation	Output	1 bit	C	-	W	-
	25	Shading deactivation status facade 2	Output	1 bit	C	R	-	T
	26	Sun protection facade 3 position %	Output	1 byte	C	R	-	T
	27	Sun protection facade 3 slat angle %	Output	1 byte	C	R	-	T
	28	Shading facade 3 deactivation	Input	1 bit	C	-	W	-
	29	Shading deactivation status facade 3	Output	1 bit	C	R	-	T
	30	Sun protection facade 4 position %	Output	1 byte	C	R	-	T

	Number	Name	Function of the object	Length	C	R	W	T
	31	Sun protection facade 4 slat angle %	Output	1 byte	C	R	-	T
	32	Shading facade 4 deactivation	Input	1 bit	C	-	W	-
	33	Shading deactivation status facade 4	Output	1 bit	C	R	-	T
	34	Presence/Absence	Input	1 bit	C	-	W	-
	35	Presence/Absence status	Output	1 bit	C	R	-	T
	36	Heat protection status	Output	1 bit	C	R	-	T
	37	Heat recovery status	Output	2 byte	C	R	-	T
	38	Indoor temperature for facade 1	Input	2 byte	C	-	W	-
	39	Wind speed simulation	Input	2 byte	C	-	W	-
	40	Luminosity simulation	Input	2 byte	C	-	W	-
	41	Outdoor T° simulation	Input	2 byte	C	-	W	-
	42	Rain simulation (1=rain)	Input	1 bit	C	-	W	-
	43	Indoor T° simulation	Input	2 byte	C	-	W	-
	44	Shading facade 1 deactivation simulation	Input	1 bit	C	-	W	-
	45	Shading facade 2 deactivation simulation	Input	1 bit	C	-	W	-
	46	Shading facade 3 deactivation simulation	Input	1 bit	C	-	W	-
	47	Shading facade 4 deactivation simulation	Input	1 bit	C	-	W	-
	48	Presence/Absence simulation	Input	1 bit	C	-	W	-
	49	Date simulation	Input	3 byte	C	-	W	-
	50	Time simulation	Input	3 byte	C	-	W	-
	51	Time and date simulation	Input	8 byte	C	-	W	-
	52	Location: Northern latitude in °	Input	4 byte	C	-	W	-
	53	Location: Eastern longitude in °	Input	4 byte	C	-	W	-
	54	Location: Northern latitude + Eastern longitude in °	Input	8 byte	C	-	W	-
	55	Simulation activation	Input	1 bit	C	-	W	-
	56	Simulation value reset	Input	1 bit	C	-	W	-
	57	Simulation activation status	Output	1 bit	C	R	-	T

3.2.1 Weather data and alarms

No.	Name	Function of the object	Data type	Flags
0	Outdoor temperature	Output	2 Byte - 9.001 DPT_Value_Temp	C, R, T
<p>These objects are always activated. This object transmits the outdoor temperature from the weather station on the KNX bus. The temperature value is periodically sent every 30 minutes and at each change in temperature if it is greater than +/- 0.5°C from the last measurement.</p> <p>Temperature measurement range: -30 to +80°C Resolution: 0.1°C</p> <p>For further information, see: Temperature measurement.</p>				

No.	Name	Function of the object	Data type	Flags
1	Wind speed	Output	2 Byte - 9.005 DPT_Value_Wsp	C, R, T
<p>These objects are always activated. This object sends the wind speed from the weather station on the KNX bus. The wind speed value is periodically sent every 30 minutes and at each change if the variation is greater than 20 % compared to the last measurement.</p> <p>Wind measurement range: 0 to 35 m/s Resolution: 0.1 m/s</p> <p>For further information, see: Wind speed.</p>				

No.	Name	Function of the object	Data type	Flags
2	Luminosity	Output	2 Byte - 9.004 DPT_Value_Lux	C, R, T
<p>These objects are always activated. This object sends the luminosity from the weather station on the KNX bus. The luminosity value is periodically sent every 30 minutes and at each change if the variation is greater than 20 % compared to the last measurement.</p> <p>Luminosity measurement range: 0 to 150 000 lux Resolution: 1 lux for 0 to 120 lux 2 lux for 121 to 1 046 lux 63 lux for 1 047 to 52 363 lux 423 lux for 52 364 to 150 000 lux</p> <p>For further information, see: Luminosity.</p>				

No.	Name	Function of the object	Data type	Flags
3	Day/night	Output	1 Bit - 1.011 DPT_State	C, R, T
<p>These objects are always activated.</p> <p>This object sends the "day/night" information from the weather station on the KNX bus.</p> <ul style="list-style-type: none"> - The "Day" information is activated (bit = 0) if the value measured is greater than the threshold value + hysteresis (12 Lux) for more than one minute (fixed value). - The "Night" information is activated (bit = 1) if the value measured is less than the threshold value (10 Lux) for one minute. <p>The information is sent 2 times every 24 hours (switching from day to night and night to day).</p> <p>For further information, see: Luminosity.</p>				

No.	Name	Function of the object	Data type	Flags
4	Wind alarm 1	Output	1 Bit - 1.005 DPT_Alarm	C, R, T
5	Wind alarm 2	Output	1 Bit - 1.005 DPT_Alarm	C, R, T
6	Wind alarm 3	Output	1 Bit - 1.005 DPT_Alarm	C, R, T
<p>These objects are always activated.</p> <p>This object sends the alarm control from the weather station on the KNX bus.</p> <ul style="list-style-type: none"> - The wind alarm is activated (bit = 1) if the value measured is greater than the threshold value for more than 2 seconds. It will immediately be transmitted and every 10 minutes thereafter. - The wind alarm is deactivated (bit = 0) if the value measured is less than the threshold value for more than 5 minutes. It will immediately be transmitted and every 10 minutes thereafter. <p>For further information, see: Wind speed.</p>				

No.	Name	Function of the object	Data type	Flags
7	Rain alarm	Output	1 Bit - 1.005 DPT_Alarm	C, R, T
<p>These objects are always activated.</p> <p>This object sends the alarm control from the weather station on the KNX bus.</p> <ul style="list-style-type: none"> - The rain alarm is activated (bit = 1) when rain is detected. It will immediately be transmitted and every 10 minutes thereafter. - The rain alarm is deactivated (bit = 0) after a period of 5 minutes after rain has stopped. It will be transmitted every 10 minutes. <p>For further information, see: Rain alarm.</p>				

No.	Name	Function of the object	Data type	Flags
8	Temperature alarm	Output	1 Bit - 1.005 DPT_Alarm	C, R, T

These objects are always activated.

This object sends the alarm control from the weather station on the KNX bus.

Example of the frost alarm:

- Temperature alarm threshold: 3°C (Default value)
- Temperature alarm: 1 if Value < Threshold / 0 if Value > Threshold + Hyst. (Default value)

- The temperature alarm is active (bit = 1) if the measured value is lower than the threshold value (3°C) for 5 minutes. It will immediately be transmitted and every 10 minutes thereafter.
- The temperature alarm is inactive (bit = 0) if the measured value rises above 5°C. It will immediately be transmitted and every 10 minutes thereafter.

For further information, see: [Temperature measurement](#).

3.2.2 Overall parameters

No.	Name	Function of the object	Data type	Flags																																																																										
9	Date slave	Input	3 Byte - 11.001 DPT_Date	C, W																																																																										
<p>This object is activated when the Date and time setting has the value Slave. This object receives the reference date of an external device.</p> <p>Object value:</p> <table border="1" style="width: 100%; text-align: center;"> <thead> <tr> <th colspan="5">Byte 3 (MSB)</th> <th colspan="5">Byte 2</th> <th colspan="7">Byte 1 (LSB)</th> </tr> <tr> <td colspan="5">Day</td> <td colspan="5">Month</td> <td colspan="7">Year</td> </tr> <tr> <td>0</td><td>0</td><td>0</td><td>D</td><td>D</td><td>D</td><td>D</td><td>D</td><td>0</td><td>0</td><td>0</td><td>0</td><td>M</td><td>M</td><td>M</td><td>M</td><td>0</td><td>Y</td><td>Y</td><td>Y</td><td>Y</td><td>Y</td><td>Y</td><td>Y</td> </tr> </thead> </table> <table border="1" style="width: 100%; text-align: center;"> <thead> <tr> <th>Fields</th> <th>Code</th> <th>Value</th> <th>Units</th> </tr> </thead> <tbody> <tr> <td>Day</td> <td>Binary</td> <td>1 to 31 (5 bit)</td> <td>Day</td> </tr> <tr> <td>Month</td> <td>Binary</td> <td>1 to 12 (4 bit)</td> <td>Month</td> </tr> <tr> <td>Year</td> <td>Binary</td> <td>0 to 99 (7 bit)</td> <td>Year</td> </tr> </tbody> </table> <p>For further information, see: Date and time.</p>					Byte 3 (MSB)					Byte 2					Byte 1 (LSB)							Day					Month					Year							0	0	0	D	D	D	D	D	0	0	0	0	M	M	M	M	0	Y	Y	Y	Y	Y	Y	Y	Fields	Code	Value	Units	Day	Binary	1 to 31 (5 bit)	Day	Month	Binary	1 to 12 (4 bit)	Month	Year	Binary	0 to 99 (7 bit)	Year
Byte 3 (MSB)					Byte 2					Byte 1 (LSB)																																																																				
Day					Month					Year																																																																				
0	0	0	D	D	D	D	D	0	0	0	0	M	M	M	M	0	Y	Y	Y	Y	Y	Y	Y																																																							
Fields	Code	Value	Units																																																																											
Day	Binary	1 to 31 (5 bit)	Day																																																																											
Month	Binary	1 to 12 (4 bit)	Month																																																																											
Year	Binary	0 to 99 (7 bit)	Year																																																																											

No.	Name	Function of the object	Data type	Flags																																																																														
10	Time slave	Input	3 Byte - 10.001 DPT_TimeOfDay	C, W																																																																														
<p>This object is activated when the Date and time setting has the value Slave. This object receives the reference time of an external device.</p> <p>Object value:</p> <table border="1" style="width: 100%; text-align: center;"> <thead> <tr> <th colspan="5">Byte 3 (MSB)</th> <th colspan="5">Byte 2</th> <th colspan="7">Byte 1 (LSB)</th> </tr> <tr> <td colspan="3">Day</td> <td colspan="2">Hours</td> <td colspan="5">Minutes</td> <td colspan="7">Seconds</td> </tr> <tr> <td>D</td><td>D</td><td>D</td><td>T</td><td>T</td><td>T</td><td>T</td><td>T</td><td>0</td><td>0</td><td>M</td><td>M</td><td>M</td><td>M</td><td>M</td><td>M</td><td>0</td><td>0</td><td>W</td><td>W</td><td>W</td><td>W</td><td>W</td><td>W</td> </tr> </thead> </table> <table border="1" style="width: 100%; text-align: center;"> <thead> <tr> <th>Fields</th> <th>Code</th> <th>Value</th> <th>Units</th> </tr> </thead> <tbody> <tr> <td>Day</td> <td>Binary</td> <td>0 = any day 1 = Monday ... 7 = Sunday (3 bit)</td> <td></td> </tr> <tr> <td>Hours</td> <td>Binary</td> <td>0 to 23 (5 bit)</td> <td>Hours</td> </tr> <tr> <td>Minutes</td> <td>Binary</td> <td>0 to 59 (6 bit)</td> <td>Minutes</td> </tr> <tr> <td>Seconds</td> <td>Binary</td> <td>0 to 59 (6 bit)</td> <td>Seconds</td> </tr> </tbody> </table> <p>For further information, see: Date and time.</p>					Byte 3 (MSB)					Byte 2					Byte 1 (LSB)							Day			Hours		Minutes					Seconds							D	D	D	T	T	T	T	T	0	0	M	M	M	M	M	M	0	0	W	W	W	W	W	W	Fields	Code	Value	Units	Day	Binary	0 = any day 1 = Monday ... 7 = Sunday (3 bit)		Hours	Binary	0 to 23 (5 bit)	Hours	Minutes	Binary	0 to 59 (6 bit)	Minutes	Seconds	Binary	0 to 59 (6 bit)	Seconds
Byte 3 (MSB)					Byte 2					Byte 1 (LSB)																																																																								
Day			Hours		Minutes					Seconds																																																																								
D	D	D	T	T	T	T	T	0	0	M	M	M	M	M	M	0	0	W	W	W	W	W	W																																																											
Fields	Code	Value	Units																																																																															
Day	Binary	0 = any day 1 = Monday ... 7 = Sunday (3 bit)																																																																																
Hours	Binary	0 to 23 (5 bit)	Hours																																																																															
Minutes	Binary	0 to 59 (6 bit)	Minutes																																																																															
Seconds	Binary	0 to 59 (6 bit)	Seconds																																																																															

No.	Name	Function of the object	Data type	Flags
11	Date and time slave	Input	8 Byte - 19.001 DPT_Date_Time	C, W

This object is activated when the **Date and time** setting has the value **Slave**.

This object receives the reference date and time of an external device.

Object value:

Byte 8 (MSB)								Byte 7								Byte 6								Byte 5							
Year								Month								Day of the month								Weekday				Hours			
Y	Y	Y	Y	Y	Y	Y	Y	0	0	0	0	M	M	M	M	0	0	0	D	D	D	D	D	D	D	D	T	T	T	T	T

Byte 4								Byte 3								Byte 2								Byte 1 (LSB)								
Minutes								Seconds								D	DW	DWV	YV	DV	WDV	TV	SWP	CA								
0	0	M	M	M	M	M	M	0	0	W	W	W	W	W	W	B	B	B	B	B	B	B	B	B	B	0	0	0	0	0	0	

Fields	Code	Value	Units
Year	Binary	0 (1900) to 255 (2155) (8 bit)	Year
Month	Binary	1 to 12 (4 bit)	Month
Day of the month	Binary	1 to 31 (5 bit)	Day
Day of the week	Binary	0 = any day 1 = Monday ... 7 = Sunday (3 bit)	
Hours	Binary	0 to 23 (5 bit)	Hours
Minutes	Binary	0 to 59 (6 bit)	Minutes
Seconds	Binary	0 to 59 (6 bit)	Seconds
Error (D)	Binary	0 = no error or 1 = error (1 bit)	
Day Worked (DW)	Binary	0 = day worked or 1 = holiday (1 bit)	
DWV (DWV)	Binary	0 = day worked valid or 1 = invalid dw (1 bit)	
Year Validated (YV)	Binary	0 = year valid or 1 = invalid year(1 bit)	
DV (DV)	Binary	0 = date valid or 1 = invalid date (1 bit)	
Weekday validated (WDV)	Binary	0 = day valid or 1 = invalid day (1 bit)	
Time Validated (TV)	Binary	0 = time valid or 1 = invalid time (1 bit)	
Summer/Winter Period (SWP)	Binary	0 = standard time or 1 = summertime (1 bit)	
Clock Accuracy (CA)	Binary	0 = no external synchronisation or 1 =external synchronisation (1 bit)	

For further information, see: [Date and time](#).

No.	Name	Function of the object	Data type	Flags
12	Date and time request	Input	1 Bit - 1.017 DPT_Trigger	C, W
<p>This object is activated when the Date and time setting has the value Master. This object receives a date and time request from an external device.</p> <p>Object value:</p> <ul style="list-style-type: none"> - If the object receives the value 1, the date and time is sent from the weather station on the KNX bus. <p>For further information, see: Date and time.</p>				

No.	Name	Function of the object	Data type	Flags																																																																								
13	Date master	Output	3 Byte - 11.001 DPT_Date	C, R, T																																																																								
<p>This object is activated when the Date and time setting has the value Master or Slave. This object sends the reference date from the weather station on the KNX bus.</p> <p>Object value:</p> <table border="1" style="width: 100%; text-align: center;"> <thead> <tr> <th colspan="5">Byte 3 (MSB)</th> <th colspan="4">Byte 2</th> <th colspan="7">Byte 1 (LSB)</th> </tr> <tr> <td colspan="5">Day</td> <td colspan="4">Month</td> <td colspan="7">Year</td> </tr> </thead> <tbody> <tr> <td>0</td><td>0</td><td>0</td><td>D</td><td>D</td><td>D</td><td>D</td><td>D</td><td>0</td><td>0</td><td>0</td><td>0</td><td>M</td><td>M</td><td>M</td><td>M</td><td>0</td><td>Y</td><td>Y</td><td>Y</td><td>Y</td><td>Y</td><td>Y</td><td>Y</td> </tr> </tbody> </table> <table border="1" style="width: 100%; text-align: center;"> <thead> <tr> <th>Fields</th> <th>Code</th> <th>Value</th> <th>Units</th> </tr> </thead> <tbody> <tr> <td>Day</td> <td>Binary</td> <td>1 to 31 (5 bit)</td> <td>Day</td> </tr> <tr> <td>Month</td> <td>Binary</td> <td>1 to 12 (4 bit)</td> <td>Month</td> </tr> <tr> <td>Year</td> <td>Binary</td> <td>0 to 99 (7 bit)</td> <td>Year</td> </tr> </tbody> </table> <p>For further information, see: Date and time.</p>					Byte 3 (MSB)					Byte 2				Byte 1 (LSB)							Day					Month				Year							0	0	0	D	D	D	D	D	0	0	0	0	M	M	M	M	0	Y	Y	Y	Y	Y	Y	Y	Fields	Code	Value	Units	Day	Binary	1 to 31 (5 bit)	Day	Month	Binary	1 to 12 (4 bit)	Month	Year	Binary	0 to 99 (7 bit)	Year
Byte 3 (MSB)					Byte 2				Byte 1 (LSB)																																																																			
Day					Month				Year																																																																			
0	0	0	D	D	D	D	D	0	0	0	0	M	M	M	M	0	Y	Y	Y	Y	Y	Y	Y																																																					
Fields	Code	Value	Units																																																																									
Day	Binary	1 to 31 (5 bit)	Day																																																																									
Month	Binary	1 to 12 (4 bit)	Month																																																																									
Year	Binary	0 to 99 (7 bit)	Year																																																																									

No.	Name	Function of the object	Data type	Flags
14	Time master	Output	3 Byte - 10.001 DPT_TimeOfDay	C, R, T

This object is activated when the **Date and time** setting has the value **Master** or **Slave**.

This object sends the reference time from the weather station on the KNX bus.

Object value:

Byte 3 (MSB)							Byte 2						Byte 1 (LSB)									
Day			Hours						Minutes						Seconds							
D	D	D	T	T	T	T	0	0	M	M	M	M	M	M	0	0	W	W	W	W	W	W

Fields	Code	Value	Units
Day	Binary	0 = any day 1 = Monday ... 7 = Sunday (3 bit)	
Hours	Binary	0 to 23 (5 bit)	Hours
Minutes	Binary	0 to 59 (6 bit)	Minutes
Seconds	Binary	0 to 59 (6 bit)	Seconds

For further information, see: [Date and time](#).

No.	Name	Function of the object	Data type	Flags
15	Date and time master	Output	8 Byte - 19.001 DPT_Date_Time	C, R, T

This object is activated when the **Date and time** setting has the value **Master** or **Slave**.
This object sends the reference date and time from the weather station on the KNX bus.

Object value:

Byte 8 (MSB)								Byte 7								Byte 6								Byte 5							
Year								Month								Day of the month								Weekday				Hours			
Y	Y	Y	Y	Y	Y	Y	Y	0	0	0	0	M	M	M	M	0	0	0	D	D	D	D	D	D	D	D	T	T	T	T	T

Byte 4								Byte 3								Byte 2								Byte 1 (LSB)								
Minutes								Seconds								D	DW	DWV	YV	DV	WDV	TV	SWP	CA								
0	0	M	M	M	M	M	M	0	0	W	W	W	W	W	W	B	B	B	B	B	B	B	B	B	B	0	0	0	0	0	0	

Fields	Code	Value	Units
Year	Binary	0 (1900) to 255 (2155) (8 bit)	Year
Month	Binary	1 to 12 (4 bit)	Month
Day of the month	Binary	1 to 31 (5 bit)	Day
Day of the week	Binary	0 = any day 1 = Monday ... 7 = Sunday (3 bit)	
Hours	Binary	0 to 23 (5 bit)	Hours
Minutes	Binary	0 to 59 (6 bit)	Minutes
Seconds	Binary	0 to 59 (6 bit)	Seconds
Error (D)	Binary	0 = no error or 1 = error (1 bit)	
Day Worked (DW)	Binary	0 = day worked or 1 = holiday (1 bit)	
DWV (DWV)	Binary	0 = day worked valid or 1 = invalid dw (1 bit)	
Year Validated (YV)	Binary	0 = year valid or 1 = invalid year(1 bit)	
DV (DV)	Binary	0 = date valid or 1 = invalid date (1 bit)	
Weekday validated (WDV)	Binary	0 = day valid or 1 = invalid day (1 bit)	
Time Validated (TV)	Binary	0 = time valid or 1 = invalid time (1 bit)	
Summer/Winter Period (SWP)	Binary	0 = standard time or 1 = summertime (1 bit)	
Clock Accuracy (CA)	Binary	0 = no external synchronisation or 1 =external synchronisation (1 bit)	

For further information, see: [Date and time](#).

No.	Name	Function of the object	Data type	Flags
16	Date and time request	Output	1 Bit - 1.017 DPT_Trigger	C, T
<p>This object is activated when the Date and time setting has the value Slave. This object sends a reference date and time request from the weather station on the KNX bus.</p> <p>Object value:</p> <ul style="list-style-type: none"> - If a date and time request is received, a telegram with the logical value 1 is sent. <p>For further information, see: Date and time.</p>				

No.	Name	Function of the object	Data type	Flags
17	GPS signal	Output	1 Bit - 1.011 DPT_State	C, R, T
<p>These objects are always activated. This object is used to emit the reception status of the weather station GPS signal on the KNX bus.</p> <p>Object value:</p> <ul style="list-style-type: none"> - If the GPS signal is present, a telegram with a logical value 1 is emitted. - If the GPS signal is not available, a telegram with a logical value 0 is emitted. <p>For further information, see: GPS signal.</p>				

3.2.3 Façades and shading

No.	Name	Function of the object	Data type	Flags
18	Sun protection facade 1 position %	Output	1 Byte - 5.001 DPT_Scaling	C, R, T
<p>This object is activated when the Facade 1 setting has the value Position tracking for shutters or Position and slat tracking for blinds. It is used for positioning the shutter or blind at the desired height, in response to the value sent on the KNX bus.</p> <p>Object value: 0 to 255</p> <ul style="list-style-type: none"> - 0 (0 %): upper position. - 255 (100 %): lower position. <p>This object is sent when there is a status change. For further information, see: Façades and shading.</p>				

No.	Name	Function of the object	Data type	Flags
19	Sun protection facade 1 slat angle %	Output	1 Byte - 5.001 DPT_Scaling	C, R, T
<p>This object is activated when the Facade 1 setting has the value Position and slat tracking for blinds. It is used to position the shutter or blind in response to the value that is sent on the KNX bus.</p> <p>Object value: 0 to 255</p> <ul style="list-style-type: none"> - 0 (0 %): slats open. - 255 (100 %): slats closed. <p>This object is sent when there is a status change. For further information, see: Façades and shading.</p>				

No.	Name	Function of the object	Data type	Flags
20	Shading facade 1 deactivation	Input	1 Bit - 1.003 DPT_Enable	C, W
<p>This object is activated when the Facade 1 setting has the value Position tracking for shutters or Position and slat tracking for blinds.</p> <p>It disables the shading for facade 1. The deactivation control can be in the form of a supervision system or push button.</p> <p>Object value:</p> <ul style="list-style-type: none"> - If the facade 1 shading deactivation object receives the value 0, sun protection of the relevant facade is authorised. - If the facade 1 shading deactivation object receives the value 1, sun protection of the relevant facade is not authorised. <p>For further information, see: Façades and shading.</p>				

No.	Name	Function of the object	Data type	Flags
21	Shading deactivation status facade 1	Output	1 Bit - 1.003 DPT_Enable	C, R, T
<p>This object is activated when the Facade 1 setting has the value Position tracking for shutters or Position and slat tracking for blinds.</p> <p>The facade 1 shading deactivation status object transmits the facade 1 shading deactivation object status.</p> <p>Object value:</p> <ul style="list-style-type: none"> - If shading deactivation is authorized for facade 1, a telegram with logical value 1 is sent. - If shading deactivation is not authorized for facade 1, a telegram with logical value 0 is sent. <p>For further information, see: Façades and shading.</p>				

No.	Name	Function of the object	Data type	Flags
22	Sun protection facade 2 position %	Output	1 Byte - 5.001 DPT_Scaling	C, R, T
See object No. 18				

No.	Name	Function of the object	Data type	Flags
23	Sun protection facade 2 slat angle %	Output	1 Byte - 5.001 DPT_Scaling	C, R, T
See object No. 19				

No.	Name	Function of the object	Data type	Flags
24	Shading facade 2 deactivation	Input	1 Bit - 1.003 DPT_Enable	C, W
See object No. 20				

No.	Name	Function of the object	Data type	Flags
25	Shading deactivation status facade 2	Output	1 Bit - 1.003 DPT_Enable	C, R, T
See object No. 21				

No.	Name	Function of the object	Data type	Flags
26	Sun protection facade 3 position %	Output	1 Byte - 5.001 DPT_Scaling	C, R, T
See object No. 18				

No.	Name	Function of the object	Data type	Flags
27	Sun protection facade 3 slat angle %	Output	1 Byte - 5.001 DPT_Scaling	C, R, T
See object No. 19				

No.	Name	Function of the object	Data type	Flags
28	Shading facade 3 deactivation	Input	1 Bit - 1.003 DPT_Enable	C, W
See object No. 20				

No.	Name	Function of the object	Data type	Flags
29	Shading deactivation status facade 3	Output	1 Bit - 1.003 DPT_Enable	C, R, T
See object No. 21				

No.	Name	Function of the object	Data type	Flags
30	Sun protection facade 4 position %	Output	1 Byte - 5.001 DPT_Scaling	C, R, T
See object No. 18				

No.	Name	Function of the object	Data type	Flags
31	Sun protection facade 4 slat angle %	Output	1 Byte - 5.001 DPT_Scaling	C, R, T
See object No. 19				

No.	Name	Function of the object	Data type	Flags
32	Shading facade 4 deactivation	Input	1 Bit - 1.003 DPT_Enable	C, W
See object No. 20				

No.	Name	Function of the object	Data type	Flags
33	Shading deactivation status facade 4	Output	1 Bit - 1.003 DPT_Enable	C, R, T
See object No. 21				

3.2.4 Automatic control

No.	Name	Function of the object	Data type	Flags
34	Presence/Absence	Input	1 Bit - 1.003 DPT_Enable	C, W
<p>This object is activated when the Presence/absence parameter is active.</p> <p>It is used to notify the presence or absence of the user to manage activation or deactivation of shading per facade, heat protection or heat recovery.</p> <p>Object value:</p> <ul style="list-style-type: none"> - If the Présence/absence object receives the value 0, this means that the user is absent. - If the Présence/absence object receives the value 1, this means that the user is present. <p>For further information, see: Presence/Absence.</p>				

No.	Name	Function of the object	Data type	Flags
35	Presence/Absence status	Output	1 Bit - 1.003 DPT_Enable	C, R, T
<p>This object is activated when the Presence/absence parameter is active.</p> <p>The Présence/absence status object transmits the status of the présence/absence object.</p> <p>Object value:</p> <ul style="list-style-type: none"> - If the user is absent, a telegram with a logical value 0 is emitted. - If the user is present, a telegram with a logical value 1 is emitted. <p>For further information, see: Presence/Absence.</p>				

No.	Name	Function of the object	Data type	Flags
36	Heat protection status	Output	1 Bit - 1.011 DPT_State	C, R, T
<p>This object is activated when the Use of heat protection automatic control or Use of heat recovery automatic control setting is activated.</p> <p>The Heat protection status object is used to indicate that the heat protection function is active (e.g. very sunny day in summer).</p> <p>Object value:</p> <ul style="list-style-type: none"> - If the heat protection function is activated on all the facades, a telegram with a logical value 1 is emitted. - If the heat protection function is deactivated on all the facades, a telegram with a logical value 0 is emitted. <p>For further information, see: Heat protection, heat recovery.</p>				

No.	Name	Function of the object	Data type	Flags
37	Heat recovery status	Output	1 Bit - 1.011 DPT_State	C, R, T
<p>This object is activated when the Use of heat protection automatic control or Use of heat recovery automatic control setting is activated.</p> <p>The Heat recovery status object is used to indicate that the heat recovery function is active (e.g. very sunny day in winter).</p> <p>Object value:</p> <ul style="list-style-type: none"> - if the heat recovery function is activated on all the facades, a telegram with a logical value 1 is emitted. - if the heat recovery function is deactivated on all the facades, a telegram with a logical value 0 is emitted. <p>For further information, see: Heat protection, heat recovery.</p>				

No.	Name	Function of the object	Data type	Flags
38	Indoor temperature for facade 1	Input	2 Byte - 9.001 DPT_Value_Temp	C, W
<p>This object is activated when the Use of heat protection automatic control or Use of heat recovery automatic control setting is activated.</p> <p>It receives the indoor temperature, which is transmitted by a thermostat in the room.</p> <p>Object value: -30°C to +80°C</p> <p>For further information, see: Heat protection, heat recovery.</p>				

3.2.5 Simulation

No.	Name	Function of the object	Data type	Flags
39	Wind speed simulation	Input	2 Bytes – 9.005 DPT_Value_Wsp	C, W

This object is activated when the **Alarm level simulation** parameter is active.
 This object is used to force the wind speed value of the weather station from the KNX bus in simulation mode.

Value range: 0 to 670760 m/s

For further information, see: [Simulation](#).

No.	Name	Function of the object	Data type	Flags
40	Luminosity simulation	Input	2 Bytes – 9.004 DPT_Value_Lux	C, W

This object is activated when the **Alarm level simulation** parameter is active.
 This object is used to force the luminosity value of the weather station from the KNX bus in simulation mode.

Value range: 0 to 670760 lux

For further information, see: [Simulation](#).

No.	Name	Function of the object	Data type	Flags
41	Outdoor T° simulation	Input	2 Bytes – 9.001 DPT_Value_Temp	C, W

This object is activated when the **Alarm level simulation** parameter is active.
 This object is used to force the outdoor temperature value of the weather station from the KNX bus in simulation mode.

Value range: -2730 to +670760°C

For further information, see: [Simulation](#).

No.	Name	Function of the object	Data type	Flags
42	Rain simulation (1=rain)	Input	1 Bit – 1.003 DPT_Enable	C, W

This object is activated when the **Alarm level simulation** parameter is active.
 This object is used to force the rain presence value of the weather station from the KNX bus in simulation mode.

Object value:

- If the object receives the value 0, the weather station simulates the absence of rain.
- If the object receives the value 1, the weather station simulates the presence of rain.

For further information, see: [Simulation](#).

No.	Name	Function of the object	Data type	Flags
43	Indoor T° simulation	Input	2 Bytes – 9.001 DPT_Value_Temp	C, W
<p>This object is activated when the Shading simulation, [heat recovery, protection parameter is active. This object is used to force the indoor temperature value of the weather station from the KNX bus in simulation mode.</p> <p>Value range: -2730 to +670760°C</p> <p>For further information, see: Simulation.</p>				

No.	Name	Function of the object	Data type	Flags
44	Shading facade 1 deactivation simulation	Input	1 Bit – 1.003 DPT_Enable	C, W
<p>This object is activated when the Shading simulation, [heat recovery, protection parameter is active. This object is used to activate or deactivate shading on facade 1 from the KNX bus in simulation mode.</p> <p>Object value:</p> <ul style="list-style-type: none"> - If the object receives the value 0, shading of the facade in question is authorised. - If the object receives the value 1, shading of the facade in question is not authorised. <p>For further information, see: Simulation.</p>				

No.	Name	Function of the object	Data type	Flags
45	Shading facade 2 deactivation simulation	Input	1 Bit – 1.003 DPT_Enable	C, W
See object No. 44				

No.	Name	Function of the object	Data type	Flags
46	Shading facade 3 deactivation simulation	Input	1 Bit – 1.003 DPT_Enable	C, W
See object No. 44				

No.	Name	Function of the object	Data type	Flags
47	Shading facade 4 deactivation simulation	Input	1 Bit – 1.003 DPT_Enable	C, W
See object No. 44				

No.	Name	Function of the object	Data type	Flags
48	Presence/Absence simulation	Input	1 Bit – 1.003 DPT_Enable	C, W
<p>This object is activated when the Shading simulation, [heat recovery, protection parameter is active. This object is used to force the presence/absence value of the weather station from the KNX bus in simulation mode.</p> <p>Object value:</p> <ul style="list-style-type: none"> - If the object receives value 0, the weather station simulates the absence of the user. - If the object receives the value 1, the weather station simulates the presence of the user. <p>For further information, see: Simulation.</p>				

No.	Name	Function of the object	Data type	Flags																																																																						
49	Date simulation	Input	3 Bytes – 11.001 DPT_Date	C, W																																																																						
<p>This object is activated when the Shading simulation, [heat recovery, protection parameter is active. This object forces the date value of the weather station from the KNX bus in simulation mode.</p> <p>Object value:</p> <table border="1" style="width: 100%; text-align: center;"> <thead> <tr> <th colspan="5">Byte 3 (MSB)</th> <th colspan="5">Byte 2</th> <th colspan="5">Byte 1 (LSB)</th> </tr> <tr> <td colspan="5">Day</td> <td colspan="5">Month</td> <td colspan="5">Year</td> </tr> </thead> <tbody> <tr> <td>0</td><td>0</td><td>0</td><td>D</td><td>D</td><td>D</td><td>D</td><td>D</td><td>0</td><td>0</td><td>0</td><td>0</td><td>M</td><td>M</td><td>M</td><td>M</td><td>0</td><td>Y</td><td>Y</td><td>Y</td><td>Y</td><td>Y</td><td>Y</td><td>Y</td> </tr> </tbody> </table> <table border="1" style="width: 100%; text-align: center;"> <thead> <tr> <th>Fields</th> <th>Code</th> <th>Value</th> <th>Units</th> </tr> </thead> <tbody> <tr> <td>Day</td> <td>Binary</td> <td>1 to 31 (5 bit)</td> <td>Day</td> </tr> <tr> <td>Month</td> <td>Binary</td> <td>1 to 12 (4 bit)</td> <td>Month</td> </tr> <tr> <td>Year</td> <td>Binary</td> <td>0 to 99 (7 bit)</td> <td>Year</td> </tr> </tbody> </table> <p>For further information, see: Simulation.</p>					Byte 3 (MSB)					Byte 2					Byte 1 (LSB)					Day					Month					Year					0	0	0	D	D	D	D	D	0	0	0	0	M	M	M	M	0	Y	Y	Y	Y	Y	Y	Y	Fields	Code	Value	Units	Day	Binary	1 to 31 (5 bit)	Day	Month	Binary	1 to 12 (4 bit)	Month	Year	Binary	0 to 99 (7 bit)	Year
Byte 3 (MSB)					Byte 2					Byte 1 (LSB)																																																																
Day					Month					Year																																																																
0	0	0	D	D	D	D	D	0	0	0	0	M	M	M	M	0	Y	Y	Y	Y	Y	Y	Y																																																			
Fields	Code	Value	Units																																																																							
Day	Binary	1 to 31 (5 bit)	Day																																																																							
Month	Binary	1 to 12 (4 bit)	Month																																																																							
Year	Binary	0 to 99 (7 bit)	Year																																																																							

No.	Name	Function of the object	Data type	Flags
50	Time simulation	Input	3 Bytes - 10.001 DPT_TimeOfDay	C, W

This object is activated when the **Shading simulation**, [heat recovery, protection parameter is active.
This object forces the time value of the weather station from the KNX bus in simulation mode.

Object value:

Byte 3 (MSB)					Byte 2						Byte 1 (LSB)												
Day			Hours							Minutes								Seconds					
D	D	D	T	T	T	T	T	0	0	M	M	M	M	M	M	0	0	W	W	W	W	W	W

Fields	Code	Value	Units
Day	Binary	0 = any day 1 = Monday ... 7 = Sunday (3 bit)	
Hours	Binary	0 to 23 (5 bit)	Hours
Minutes	Binary	0 to 59 (6 bit)	Minutes
Seconds	Binary	0 to 59 (6 bit)	Seconds

For further information, see: [Simulation](#).

No.	Name	Function of the object	Data type	Flags
51	Time and date simulation	Input	8 Byte - 19.001 DPT_Date_Time	C, R, T

This object is activated when the **Shading simulation**, [heat recovery, protection parameter is active.
This object forces the date and time value of the weather station from the KNX bus in simulation mode.

Object value:

Byte 8 (MSB)								Byte 7								Byte 6								Byte 5							
Year								Month								Day of the month								Weekday				Hours			
Y	Y	Y	Y	Y	Y	Y	Y	0	0	0	0	M	M	M	M	0	0	0	D	D	D	D	D	D	D	D	D	T	T	T	T

Byte 4								Byte 3								Byte 2								Byte 1 (LSB)							
Minutes								Seconds								D	DW	DWV	YV	DV	WDV	TV	SWP	CA							
0	0	M	M	M	M	M	M	0	0	W	W	W	W	W	W	B	B	B	B	B	B	B	B	B	0	0	0	0	0	0	0

Fields	Code	Value	Units
Year	Binary	0 (1900) to 255 (2155) (8 bit)	Year
Month	Binary	1 to 12 (4 bit)	Month
Day of the month	Binary	1 to 31 (5 bit)	Day
Day of the week	Binary	0 = any day 1 = Monday ... 7 = Sunday (3 bit)	
Hours	Binary	0 to 23 (5 bit)	Hours
Minutes	Binary	0 to 59 (6 bit)	Minutes
Seconds	Binary	0 to 59 (6 bit)	Seconds
Error (D)	Binary	0 = no error or 1 = error (1 bit)	
Day Worked (DW)	Binary	0 = day worked or 1 = holiday (1 bit)	
DWV (DWV)	Binary	0 = day worked valid or 1 = invalid dw (1 bit)	
Year Validated (YV)	Binary	0 = year valid or 1 = invalid year(1 bit)	
DV (DV)	Binary	0 = date valid or 1 = invalid date (1 bit)	
Weekday validated (WDV)	Binary	0 = day valid or 1 = invalid day (1 bit)	
Time Validated (TV)	Binary	0 = time valid or 1 = invalid time (1 bit)	
Summer/Winter Period (SWP)	Binary	0 = standard time or 1 = summertime (1 bit)	
Clock Accuracy (CA)	Binary	0 = no external synchronisation or 1 =external synchronisation (1 bit)	

For further information, see: [Simulation](#).

No.	Name	Function of the object	Data type	Flags
52	Location: Northern latitude in °	Input	4 Bytes – 14.007 DPT_Value_AngleDeg	C, W
<p>This object is activated when the Shading simulation, [heat recovery, protection parameter is active. This object forces the latitude value of the weather station from the KNX bus in simulation mode.</p> <p>Value range: -3.40282347e+38 to + 3.40282347e+38 (In degrees)</p> <p>For further information, see: Simulation.</p>				

No.	Name	Function of the object	Data type	Flags
53	Location: Eastern longitude in °	Input	4 Bytes – 14.007 DPT_Value_AngleDeg	C, W
<p>This object is activated when the Shading simulation, [heat recovery, protection parameter is active. This object forces the longitude value of the weather station from the KNX bus in simulation mode.</p> <p>Value range: -3.40282347e+38 to + 3.40282347e+38 (In degrees)</p> <p>For further information, see: Simulation.</p>				

No.	Name	Function of the object	Data type	Flags
54	Location: Northern latitude + Eastern longitude in °	Input	8 Bytes – 255.001 DPT_GeographicalLocation	C, W

This object is activated when the **Shading simulation**, [heat recovery, protection parameter is active.
This object forces the latitude and longitude value of the weather station from the KNX bus in simulation mode.

Object value:

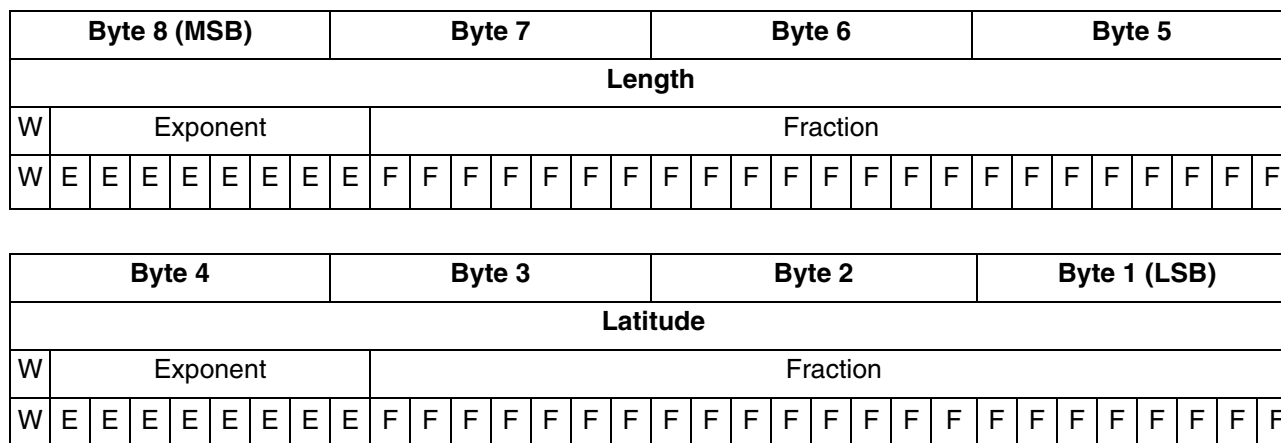

W = Sign (0 Or 1) ; E = Exponent [0...255] ; F = Fraction [0...8388607]
Value range: -3.40282347e+38 to + 3.40282347e+38 (In degrees) for latitude and longitude

For further information, see: [Simulation](#).

No.	Name	Function of the object	Data type	Flags
55	Simulation activation	Input	1 Bit - 1.003 DPT_Enable	C, W

This object is active when the **Alarm level simulation** or **Shading, protection simulation** or **heat recovery** parameter is active.

It is used to activate simulation mode.

Object value:

- If the **Simulation activation** object receives the value 0, simulation mode is inactiv.
- If the **Simulation activation** object receives the value 1, simulation mode is active.

For further information, see: [Simulation](#).

No.	Name	Function of the object	Data type	Flags
56	Simulation value reset	Input	1 Bit - 1.003 DPT_Enable	C, W
<p>This object is active when the Alarm level simulation or Shading, protection simulation or heat recovery parameter is active. It enables the simulation object default values to be reset.</p> <p>Object value:</p> <ul style="list-style-type: none"> - If the Simulation value reset object receives the value 0, the simulation object values are not reset. - If the Simulation value reset object receives the value 1, the simulation object values are reset. <p>List of the objects in question:</p> <ul style="list-style-type: none"> Wind speed simulation Luminosity simulation Outdoor T° simulation Rain simulation (1=rain) Indoor T° simulation Shading facade 1 deactivation simulation Shading facade 2 deactivation simulation Shading facade 3 deactivation simulation Shading facade 4 deactivation simulation Presence/Absence simulation Date simulation Time simulation Time and date simulation Location: Northern latitude in ° Location: Eastern longitude in ° Location: Northern latitude + Eastern longitude in ° <p>For further information, see: Simulation.</p>				

No.	Name	Function of the object	Data type	Flags
57	Simulation activation status	Output	1 Bit - 1.003 DPT_Enable	C, R, T
<p>This object is active when the Alarm level simulation or Shading, protection simulation or heat recovery parameter is active.</p> <p>The Simulation activation status object is used to transmit the Simulation activation object.</p> <p>Object value:</p> <ul style="list-style-type: none"> - If simulation is activated, a telegram with a logical value 1 is emitted. - If simulation is not activated, a telegram with a logical value 0 is emitted. <p>For further information, see: Simulation.</p>				

4. Programming by Easy Tool

4.1 Product overview

TXE531: Weather station

Product view:

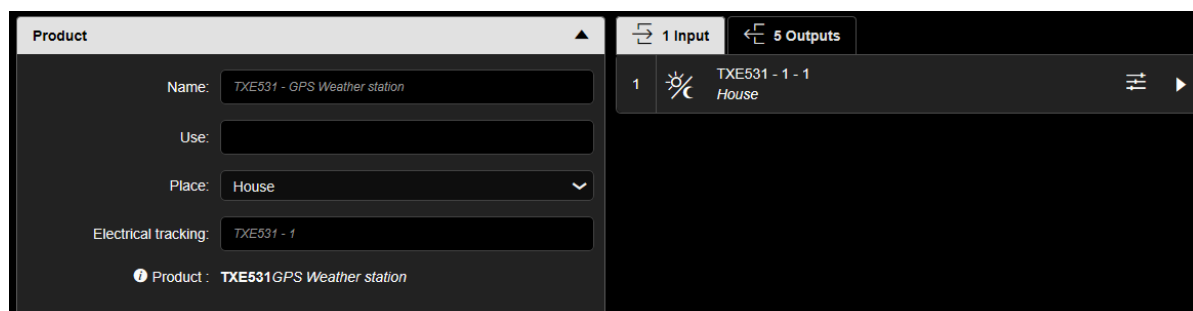

View of channels:

1 Input	
	TXE531 - 1 - 1 Housing

5-fold output	
	TXE531 - 1 - 1 Housing - Common function
	TXE531 - 1 - 2 Housing - Common function
	TXE531 - 1 - 3 Housing - Common function
	TXE531 - 1 - 4 Housing - Common function
	TXE531 - 1 - 5 Housing - Common function

	Day/night
	Shading facade 1 deactivation
	Shading facade 2 deactivation
	Shading facade 3 deactivation
	Shading facade 4 deactivation
	Presence/Absence - Indoor temperature

Product settings:

- Input

Settings	
Temperature alarm threshold (-20°C - 50°C):	3
Temperature alarm:	1 if Value < Threshold / 0 if Value > Threshold + H...
Day/Night threshold (5 - 50 Lux):	10
Wind speed threshold 1 (10 - 100 km/h):	15
Wind speed threshold 2 (10 - 100 km/h):	30
Wind speed threshold 3 (10 - 100 km/h):	45

- Output

Facade 1	Facade 2																				
<table border="1"> <thead> <tr> <th colspan="2">Settings</th> </tr> </thead> <tbody> <tr> <td>Facade 1:</td> <td>Not active</td> </tr> <tr> <td>Orientation facade 1:</td> <td>S - 180°</td> </tr> <tr> <td>Shading control facade 1:</td> <td>Disable</td> </tr> <tr> <td>Max shading position (20 - 80%) facade 1:</td> <td>80</td> </tr> </tbody> </table>	Settings		Facade 1:	Not active	Orientation facade 1:	S - 180°	Shading control facade 1:	Disable	Max shading position (20 - 80%) facade 1:	80	<table border="1"> <thead> <tr> <th colspan="2">Settings</th> </tr> </thead> <tbody> <tr> <td>Facade 2:</td> <td>Not active</td> </tr> <tr> <td>Orientation facade 2:</td> <td>W - 270°</td> </tr> <tr> <td>Shading control facade 2:</td> <td>Disable</td> </tr> <tr> <td>Max shading position (20 - 80%) facade 2:</td> <td>80</td> </tr> </tbody> </table>	Settings		Facade 2:	Not active	Orientation facade 2:	W - 270°	Shading control facade 2:	Disable	Max shading position (20 - 80%) facade 2:	80
Settings																					
Facade 1:	Not active																				
Orientation facade 1:	S - 180°																				
Shading control facade 1:	Disable																				
Max shading position (20 - 80%) facade 1:	80																				
Settings																					
Facade 2:	Not active																				
Orientation facade 2:	W - 270°																				
Shading control facade 2:	Disable																				
Max shading position (20 - 80%) facade 2:	80																				

Facade 3	Facade 4																				
<table border="1"> <thead> <tr> <th colspan="2">Settings</th> </tr> </thead> <tbody> <tr> <td>Facade 3:</td> <td>Not active</td> </tr> <tr> <td>Orientation facade 3:</td> <td>E - 90°</td> </tr> <tr> <td>Shading control facade 3:</td> <td>Disable</td> </tr> <tr> <td>Max shading position (20 - 80%) facade 3:</td> <td>80</td> </tr> </tbody> </table>	Settings		Facade 3:	Not active	Orientation facade 3:	E - 90°	Shading control facade 3:	Disable	Max shading position (20 - 80%) facade 3:	80	<table border="1"> <thead> <tr> <th colspan="2">Settings</th> </tr> </thead> <tbody> <tr> <td>Facade 4:</td> <td>Not active</td> </tr> <tr> <td>Orientation facade 4:</td> <td>N - 0°</td> </tr> <tr> <td>Shading control facade 4:</td> <td>Disable</td> </tr> <tr> <td>Max shading position (20 - 80%) facade 4:</td> <td>80</td> </tr> </tbody> </table>	Settings		Facade 4:	Not active	Orientation facade 4:	N - 0°	Shading control facade 4:	Disable	Max shading position (20 - 80%) facade 4:	80
Settings																					
Facade 3:	Not active																				
Orientation facade 3:	E - 90°																				
Shading control facade 3:	Disable																				
Max shading position (20 - 80%) facade 3:	80																				
Settings																					
Facade 4:	Not active																				
Orientation facade 4:	N - 0°																				
Shading control facade 4:	Disable																				
Max shading position (20 - 80%) facade 4:	80																				

Heat protection, heat recovery	
Settings	
Heat Protection:	Disable
Heat protection T° threshold (30°C - 36°C):	30
Heat Recovery:	Disable
Heat recovery T° threshold (10°C - 15°C):	12

4.2 Date and time

The GPS module built into the device is able to send the date and time to the bus. When the weather station is set without restrictions, data is sent every 12 hours (fixed value) and during the time changes between summer and winter.

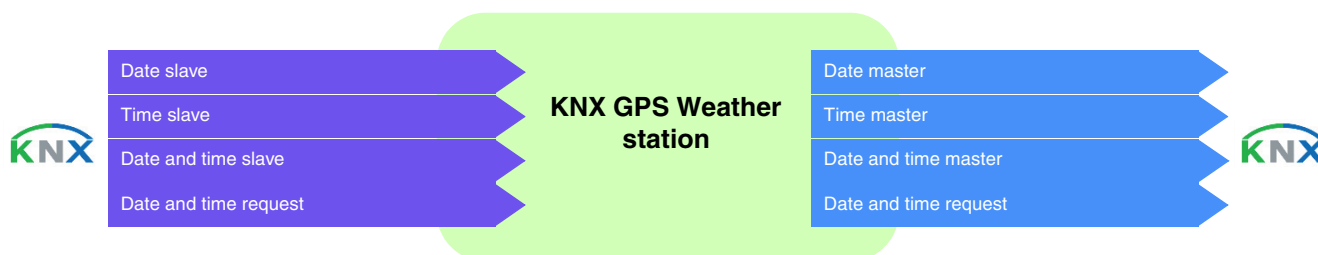

Date and time for Master

The device uses the time data from another device on the bus.

In the first instance, the current date and time can be set via the ETS. The weather station works with this data until a valid GPS signal is received for the first time.

Date and time for Slave

The device receives the time data through GPS and sends it to the KNX bus every 12 hours.

In slave mode, the weather station synchronizes itself to the date and time of the master system. However, it always operates with its own date and time when calculating the azimuth and elevation.

When the weather station does not receive the date and time information after 2 successive tries (fixed value), it will send a request. If there is no response, the weather station switches automatically to master mode. When the master device re-sends the date and time, the weather station returns to slave mode.

Date and time in Autonomous mode

The device receives the time data through the GPS and does not send it to the KNX bus.

The weather station operates with its own date and time to calculate the azimuth and elevation. No item is sent to or read on the KNX bus.

The time change is carried out automatically according to the Central Europe criteria.

■ Links

For this function, the link is made automatically if compatible products are present in the installation.

This automatic link is used for several products. They are composed of several objects:

- date and time
- time
- date

The information from these objects may come from 3 different sources, each with its own priority:

- The domovea system (priority 1 - the highest)
- The weather station (priority 2 - medium)
- A clock (priority 3 - the lowest)

If there is a domovea system in the installation, the reference date and time will come from this system (priority 1). Otherwise, it is the weather station that will send the reference date and time (priority 2). And finally, if there are none of these products in the installation, the reference date and time will be sent by a clock (See the illustration below).

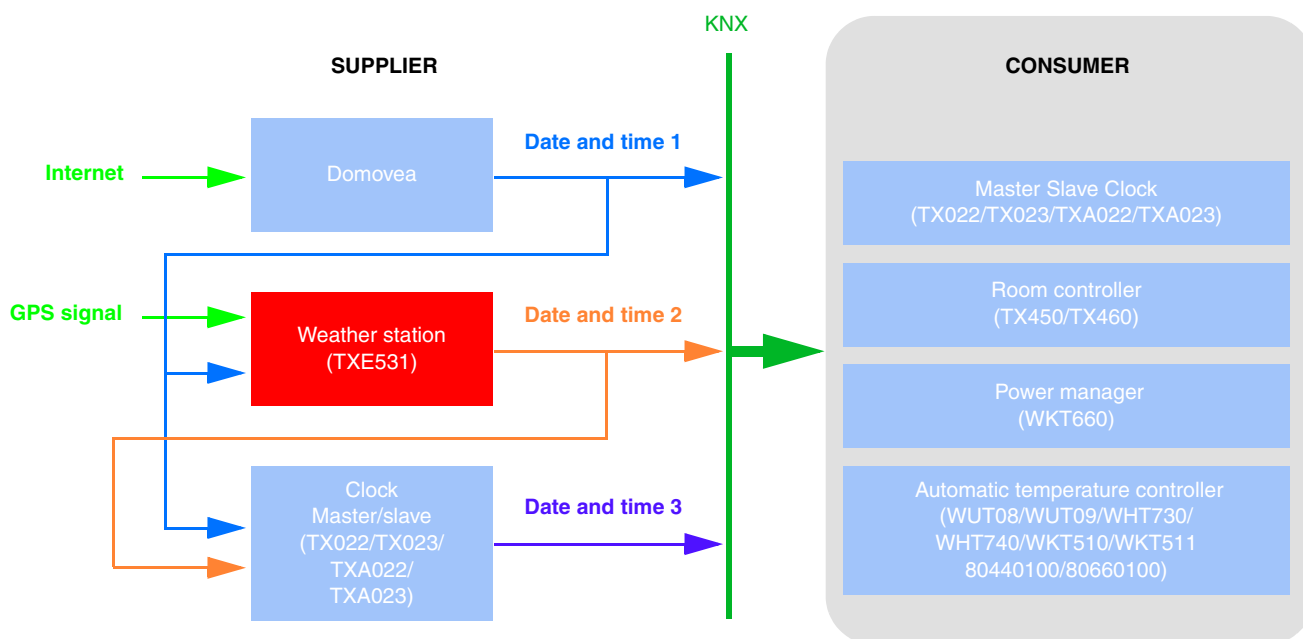

Note: At the end of detection, the configuration tool sends the date and time on the predefined group address Date and time 3, Time 3 and Date 3. This means that at the end of the scan, the products requiring the date and time are immediately updated.

A request system (Date and time request) was installed for automatic management of the date and time.

■ Group address

Date 1	30/0/032
Time 1	30/0/033
Date and time 1	30/0/034
Date 2	30/0/035
Time 2	30/0/036
Date and time 2	30/0/037
Date 3	30/0/038
Time 3	30/0/039
Date and time 3	30/0/040
Request Date and time	30/0/041

4.3 Outdoor temperature - Temperature alarm

The outdoor temperature is mainly used for the heating, ventilation and air conditioning systems. It can also be used as a display on touch screens.



The temperature value is periodically sent every 30 minutes and at each change in temperature if it is greater than +/- 0.5°C from the last measurement.

Temperature alarm:

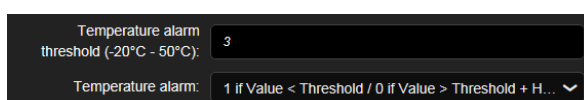

Parameter	Description	Value
Temperature alarm threshold	Used to define the temperature threshold value to activate the alarm.	-20 ... 3* ... 50°C
Temperature alarm	Used to define the polarity of the temperature alarm.	1 if Value > Threshold / 0 if Value < Threshold - Hyst. 0 if Value > Threshold / 1 if Value < Threshold - Hyst. 1 if Value < Threshold / 0 if Value > Threshold + Hyst.* 0 if Value < Threshold / 1 if Value > Threshold + Hyst.

In order to validate alarm activation, the measured value must be lower than or higher than the threshold value **for 5 minutes**. To deactivate the alarm, the measured value must be lower than or higher than the threshold value plus or minus the hysteresis value set at 3°C.

Example of the frost alarm:

- Temperature alarm threshold: 3°C (Default value)
- Temperature alarm: 1 if Value < Threshold / 0 if Value > Threshold + Hyst. (Default value)
- The temperature alarm is active (bit = 1) if the measured value is lower than the threshold value (3°C) for 6 minutes. It will immediately be transmitted and every 10 minutes thereafter.
- The temperature alarm is inactive (bit = 0) if the measured value rises above 6°C. It will immediately be transmitted and every 10 minutes thereafter.

■ Links

For this function, the link can be automatically established 2 ways:

- by the presence of other compatible products
- by configuration
- Automatic links

This automatic link is used for several products. They have a channel that enables the display or use of the outdoor temperature and the temperature alarm.

* Default value

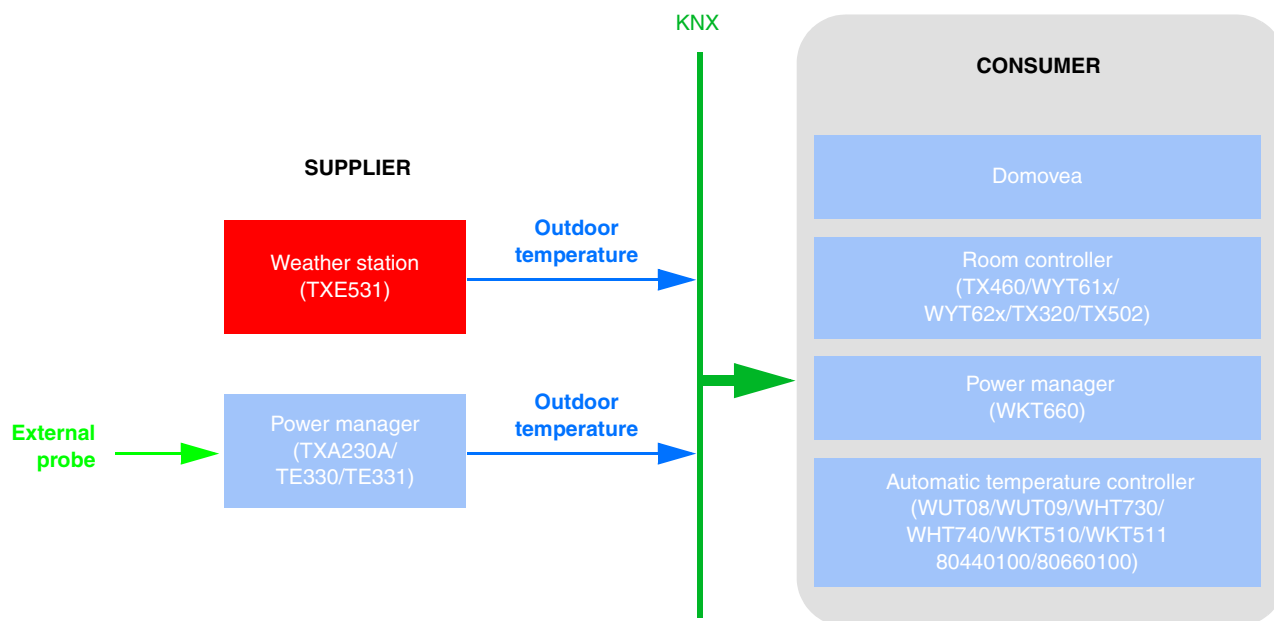

Note: The presence of the weather station implies that the power manager requires no probe. A single outdoor temperature probe is sufficient.

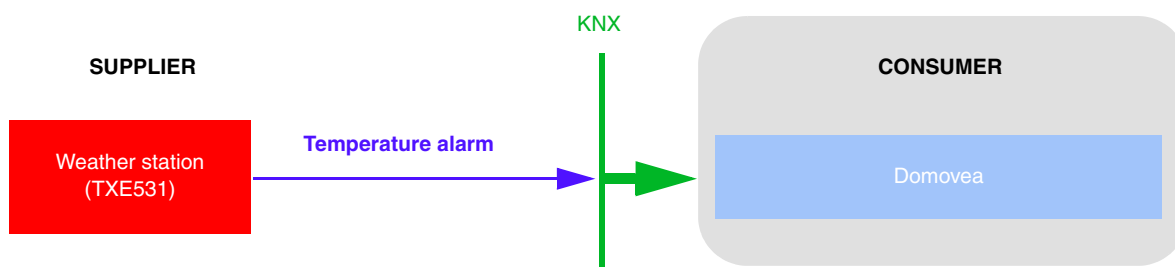

■ Group address

Outdoor temperature	30/0/000
Temperature alarm	30/0/012

4.4 Luminosity - Day/night

The outdoor luminosity is mainly used for lighting control systems and shading management, taking the position of the sun into account. It can also be used as a display on touch screens.



The luminosity value is periodically sent every 30 minutes and at each change if the variation is greater than 20 % compared to the last measurement.

Day/night info:



Parameter	Description	Value
Day/night threshold	Used to define the luminosity threshold value for the detection of day or night.	5 ... 10* ... 50 lux

An emission delay is necessary to avoid having more than one day/night change per day. The information is sent 2 times every 24 hours (switching from day to night and night to day).

Example of day/night information operation (with default values):

- The "Day" information is activated (bit = 0) if the value measured is greater than the threshold value + hysteresis (12 Lux) for more than one minute (fixed value).
- The "Night" information is activated (bit = 1) if the value measured is less than the threshold value (10 Lux) for one minute.

■ Links

For this function, the link is made automatically if compatible products are present in the installation.

This automatic link is used by twilight switches. They have a luminosity, master and slave channel. The domovea supervision system also uses this link but only for the slave channel. Products are in slave mode by default. They switch to master mode when a luminosity probe is connected to the product.

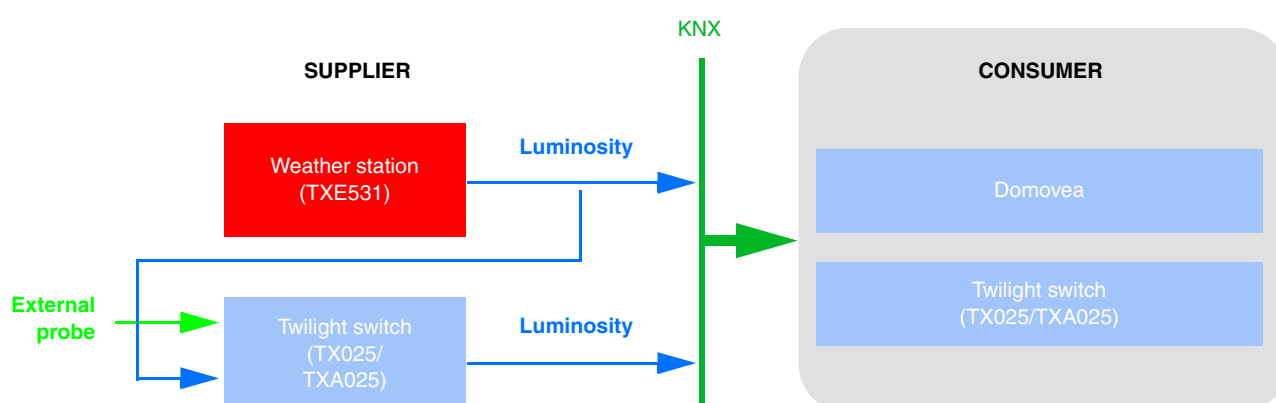

Note: The presence of the weather station implies that the twilight switch does not require a probe. A single luminosity probe is sufficient.

* Default value

This automatic link is used by LED push buttons, thermostats and the domovea supervision system. They have a channel to control the indicator lights on the front panel.

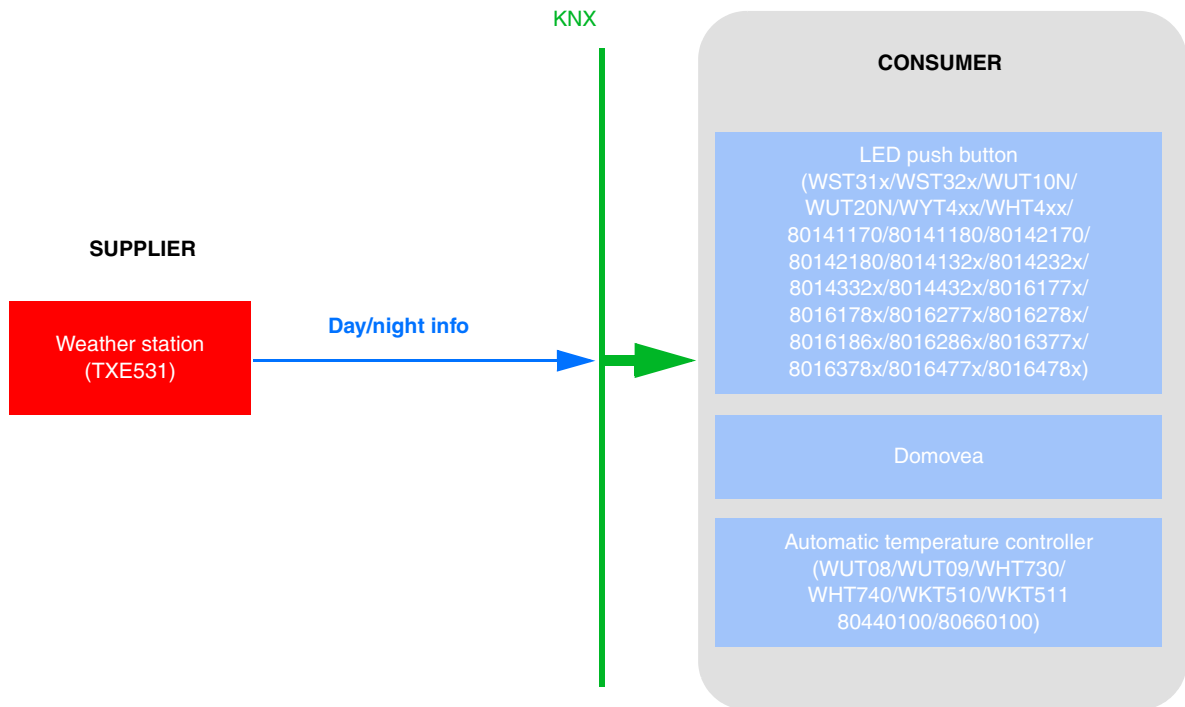

To control the push button lighting using the day/night information, the FPL function must be set up in the product.

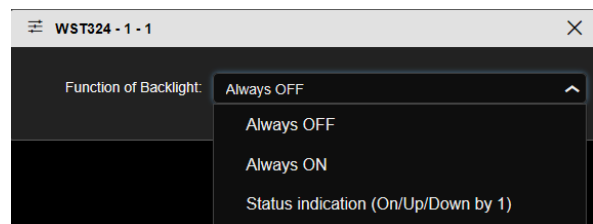

To control the push button LEDs using the day/night information, the LED function must be set up in the product.

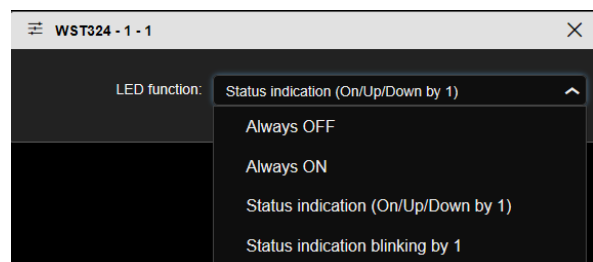

*Note: For the **LED function status** setting to appear, a function must be defined in the corresponding input.*

- Another possible link: (Compatible software version TXA100: V 1.5.0 or higher)
 The Day/night information can also be used to control the lighting or shutter outputs.

Lighting:

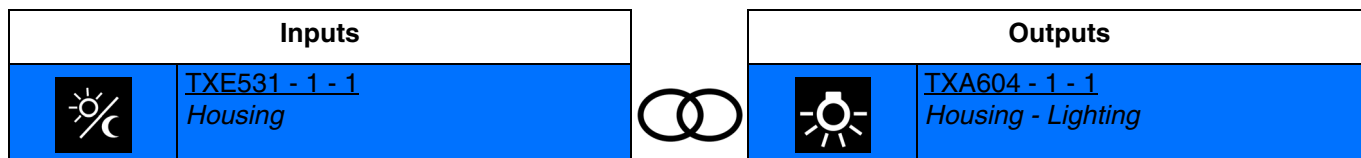

Day information: Turns off the light
 Night information: Turn on the light

Shutter:

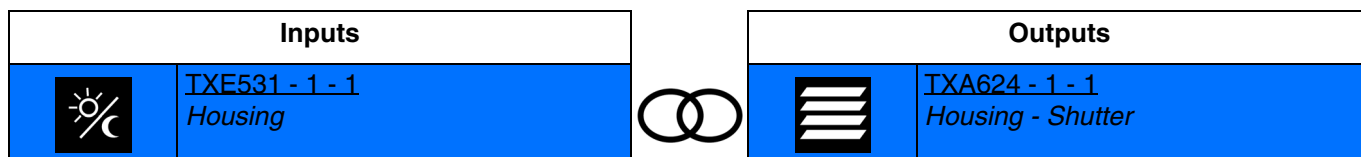

Day information: Up control
 Night information: Down control

■ Group address

Luminosity	30/0/002
Day/night	30/0/003

4.5 Wind speed - wind alarm

The wind speed value is mainly used to secure shutters and blinds. It can also be used as a display on touch screens.

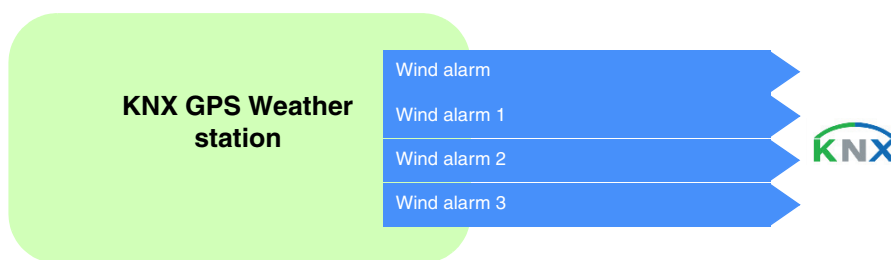

The wind speed value is periodically sent every 30 minutes and at each change if the variation is greater than 20% compared to the last measurement.

Wind alarm:

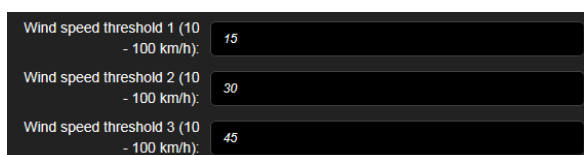

Parameter	Description	Value
Wind alarm 1 threshold	Used to define the wind speed threshold value for wind alarm 1.	10 ... 15* ... 100 km/h
Wind alarm 2 threshold	Used to define the wind speed threshold value for wind alarm 2.	10 ... 30* ... 100 km/h
Wind alarm 3 threshold	Used to define the wind speed threshold value for wind alarm 3.	10 ... 45* ... 100 km/h

The wind alarm (1 to 3) operates as follows:

- The wind alarm is activated (bit = 1) if the value measured is greater than the threshold value for more than 2 seconds. It will immediately be transmitted and every 10 minutes thereafter.
- The wind alarm is deactivated (bit = 0) if the value measured is less than the threshold value for more than 5 minutes. It will immediately be transmitted and every 10 minutes thereafter.

■ Links

For this function, the link can be automatically established 2 ways:

- By the presence of other compatible products
- By configuration
- Automatic links

This automatic link is used by the domovea supervision system. It has a channel that can display the wind speed and wind alarms.

* Default value

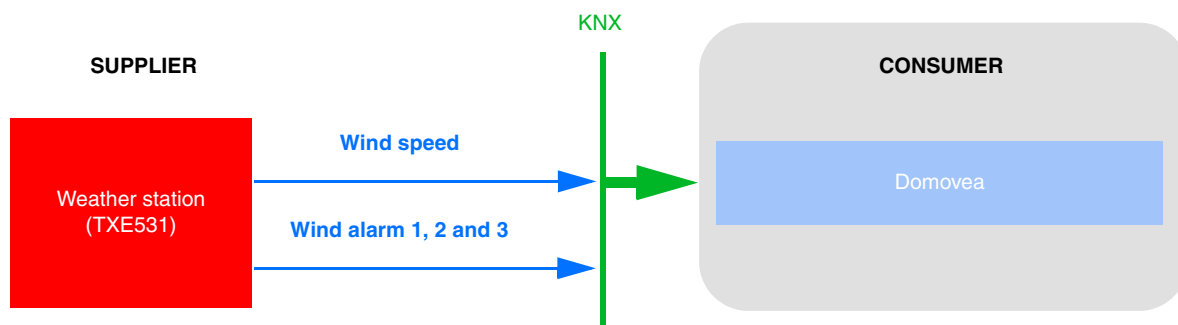

- Automatic links through configuration

This link is established depending on the configuration of products. For the wind alarm, please refer to the shutter configuration.

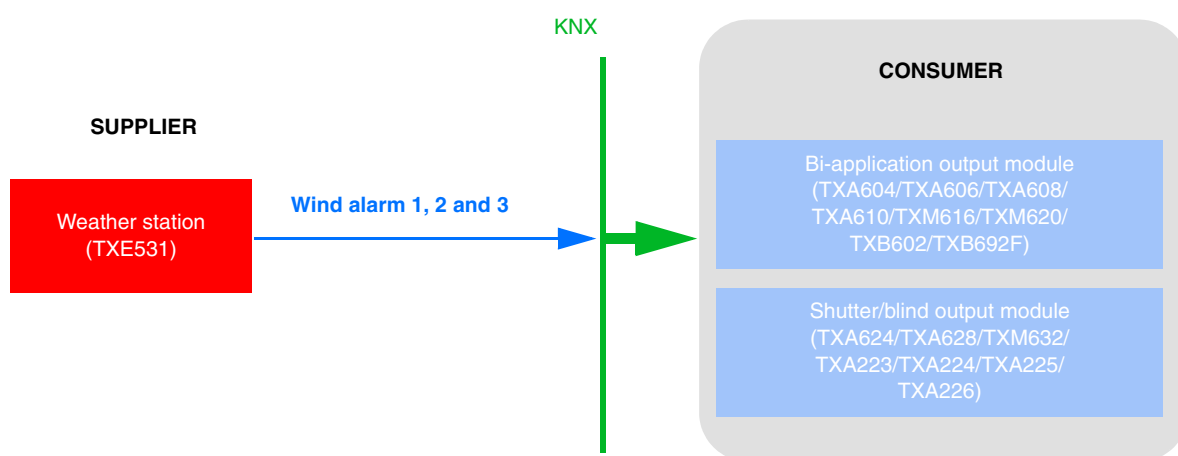

- TXA624 configuration:

Wind Alarm level: No Wind alarm ▼

Position on wind alarm: Not active ▼

Parameter	Description	Value
Wind alarm stepping switch	Activates the shutter output on receipt of wind alarms 1, 2 or 3.	No wind alarm* Wind alarm 1 Wind alarm 2 Wind alarm 3
Position on wind alarm	Defines the status of the shutter output on receipt of wind alarms 1, 2 or 3.	Not active* Up Down

Note: For the TXA223 TXA224 TXA225 and TXA226 shutter output modules, only wind alarm 1 is available.

■ Group address

Wind speed	30/0/001
Wind alarm 1	30/0/008
Wind alarm 2	30/0/009
Wind alarm 3	30/0/010

* Default value

4.6 Rain alarm

The rain alarm mainly controls the opening and closing of canopies or skylights. It can also be used as a display on touch screens.



The rain alarm operates as follows:

- The rain alarm is activated (bit = 1) when rain is detected. It will immediately be transmitted and every 10 minutes thereafter.
- The rain alarm is deactivated (bit = 0) after a period of 5 minutes after rain has stopped. It will immediately be transmitted and every 10 minutes thereafter.

■ Links

For this function, the link can be automatically established 2 ways:

- by the presence of other compatible products
- by configuration

- Automatic links

This automatic link is used for several products. It has a channel that can display or use the rain alarm.

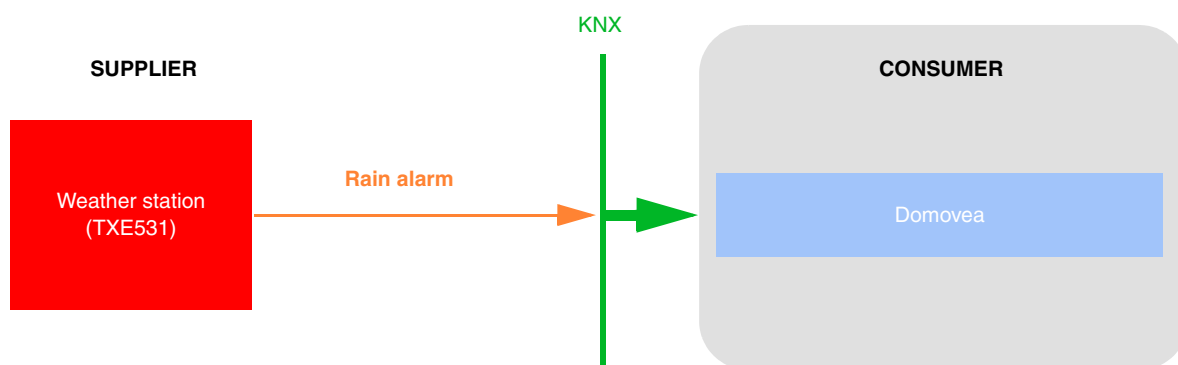

- Automatic links through configuration

This link is established depending on the configuration of products. For the rain alarm, please see the shutter configuration.

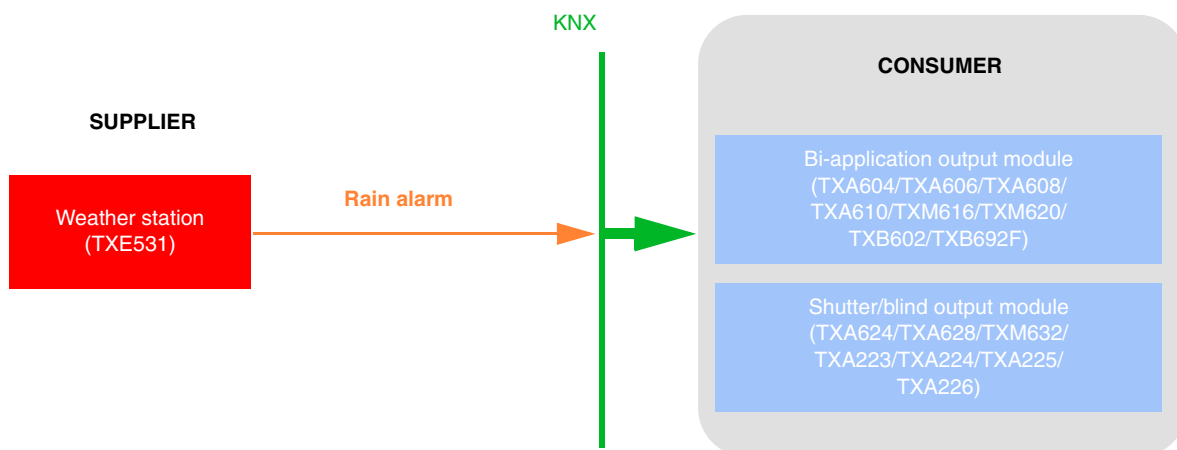

- TXA624 configuration:

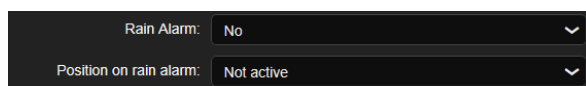

Parameter	Description	Value
Rain alarm	Activates the shutter output on receipt of the rain alarm.	Yes No*
Position on rain alarm	Defines the status of the shutter output on receipt of the rain alarm	Not active* Up Down

Note: At the end of the alarm, the shutter status depends on the configuration of the shutter output modules.

■ Group address

Rain alarm	30/0/011
------------	----------

* Default value

4.7 Façades and shading

The aim of the shading function is to provide further comfort for people in the room by preventing glare from the sun. To simplify the use and configuration of the weather station, we recommend working with façades that are fitted only with shutters or only with blinds.

The shading control options (blind or louver position and slat tilt positions) are associated with façades.

The weather station is particularly suitable in the following cases:

- The shading function (comfort priority) when people are present.
- Heat recovery and protection (energy saving priority) when the room is empty.



Facade controls

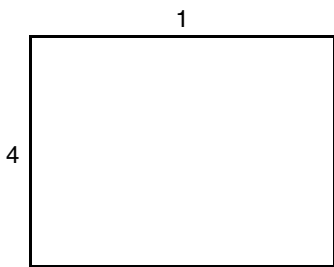

The majority of buildings have 4 façades. Creating a separate command for the sun protection of each facade is recommended.

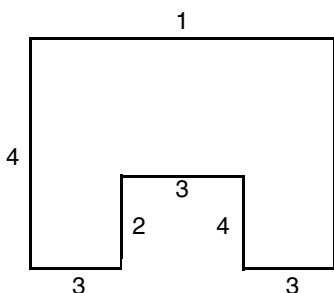

For U shaped buildings, only 4 façades must be controlled separately, insofar as several are facing the same direction.

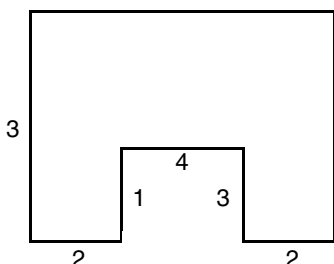

To manage shading on a facade with both blinds and shutters, two façades must be registered: one for blinds and one for shutters. Here, facade 2 is for shutters and facade 4 is for blinds.

Facade direction

The direction of each facade must be defined in the setup for the shading function to operate correctly.

- Defining the direction of each facade used.

Example 1:

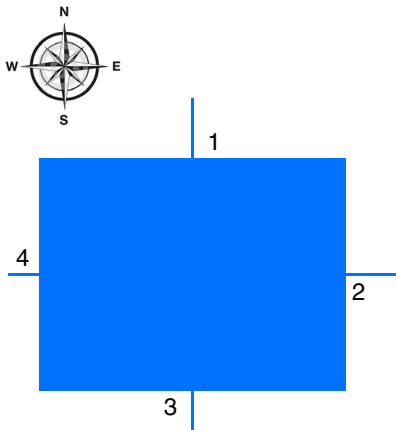

Direction:

- Facade 1: $N = 0^\circ$
- Facade 2: $E = 90^\circ$
- Facade 3: $S = 180^\circ$
- Facade 4: $W = 270^\circ$

Example 2:

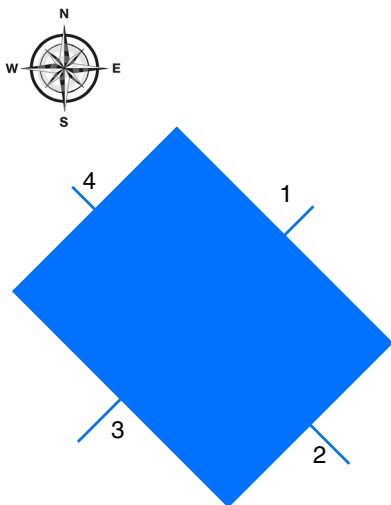

Direction:

- Facade 1: $NE = 45^\circ$
- Facade 2: $SE = 135^\circ$
- Facade 3: $SW = 225^\circ$
- Facade 4: $NW = 315^\circ$

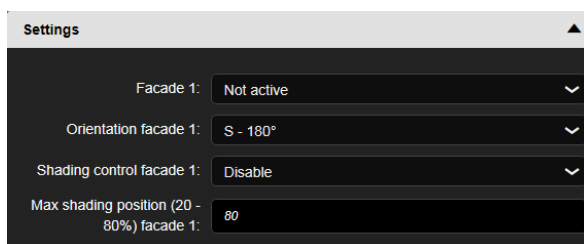

Parameter	Description	Value
Facade x	<p>The facade is not used for position tracking.</p> <p>The facade is used for position tracking the rolling shutters only.</p> <p>The facade is used for position tracking the blinds (position and tilt). The blind tilting control varies by an angle of between 0 and 180°.</p> <p>The facade is used for position tracking the blinds (position and tilt). The blind tilting control varies by an angle of between 90 and 180°.</p>	<p>Not active*</p> <p>Position</p> <p>0 to 180° tilt</p> <p>90 to 180° tilt</p>
Facade orientation x	This setting defines the direction of the facade according to the compass points.	<p>N = 0°</p> <p>NE = 45°</p> <p>E = 90°</p> <p>SE = 135°</p> <p>S = 180°</p> <p>SW = 225°</p> <p>W = 270°</p> <p>NW = 315°</p> <p>All = 360°</p>
Shading facade x	<p>The shading function is not validated on this facade.</p> <p>The shading function is validated on this facade.</p>	<p>Not active*</p> <p>Active</p>

x = 1 to 4

Note: To manage a glazed roof or partially glazed roof, the roof must be declared as one of the facades with the setting (All = 360°).

Note: Operation is only provided for blinds with horizontal slats or rolling shutters.

* Default value

Valid zones according to the horizontal position of the sun:

Parameter	Direction	Valid zone
N = 0°	North	270° to 90°
NE = 45°	North - East	315° to 135°
E = 90°	East	0° to 180°
SE = 135°	South - East	45° to 225°
S = 180°	South	90° to 270°
SW = 225°	South - West	135° to 315°
W = 270°	West	180° to 360°
NW = 315°	North - West	225° to 45°
All = 360°		0° to 360°

The valid zone according to the vertical position of the sun is 0° to 90°.

Shading concept for rolling shutters and slat blinds:

With shading tracking, the sun protection is not fully lowered, thus allowing the sun to penetrate the room. In this way, users at the bottom of the window can see out and plants on the windowsill will receive sunshine.

Note: Shading tracking can only be used when the sun protection is lowered from top to bottom (such as shutters, textile sun protection or blinds with horizontal slats). This function is not usable for a sun protection that is pulled from one side to the other or pulled in front of a window from both sides.

Shading with roller shutters

Shading is automatically controlled if the shading conditions on the relevant facade are fulfilled: luminosity threshold > 40 klux and sun on the facade. The shading thus moves in line with the path of the sun. It starts with a configurable minimum shutter closure value and maximum closure value of between 20 and 80%. Full automatic closure can only be obtained if the heat protection function is activated.

Example of 80% maximum closure (default value):

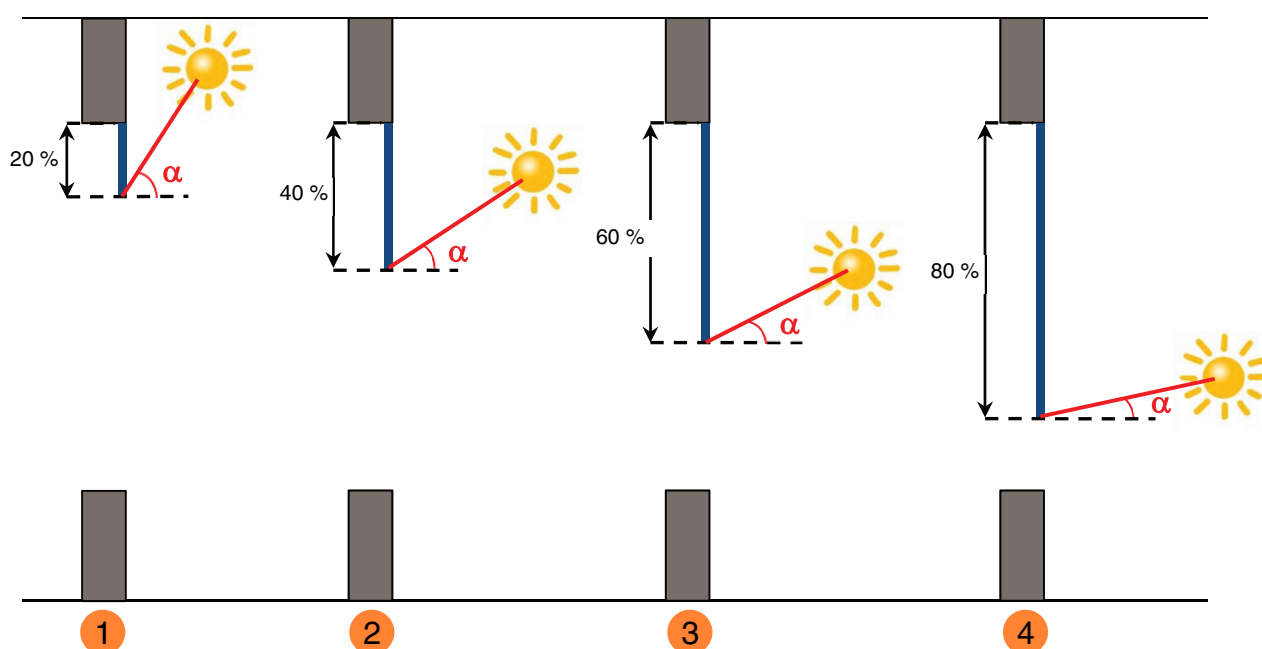

Example	Shutter position	Sun position - Angle α between
1	20%	46° ... 90°
2	40%	31° ... 45°
3	60%	16° ... 30°
4	80%	0° ... 15°

Example with maximum closure set at 40%:

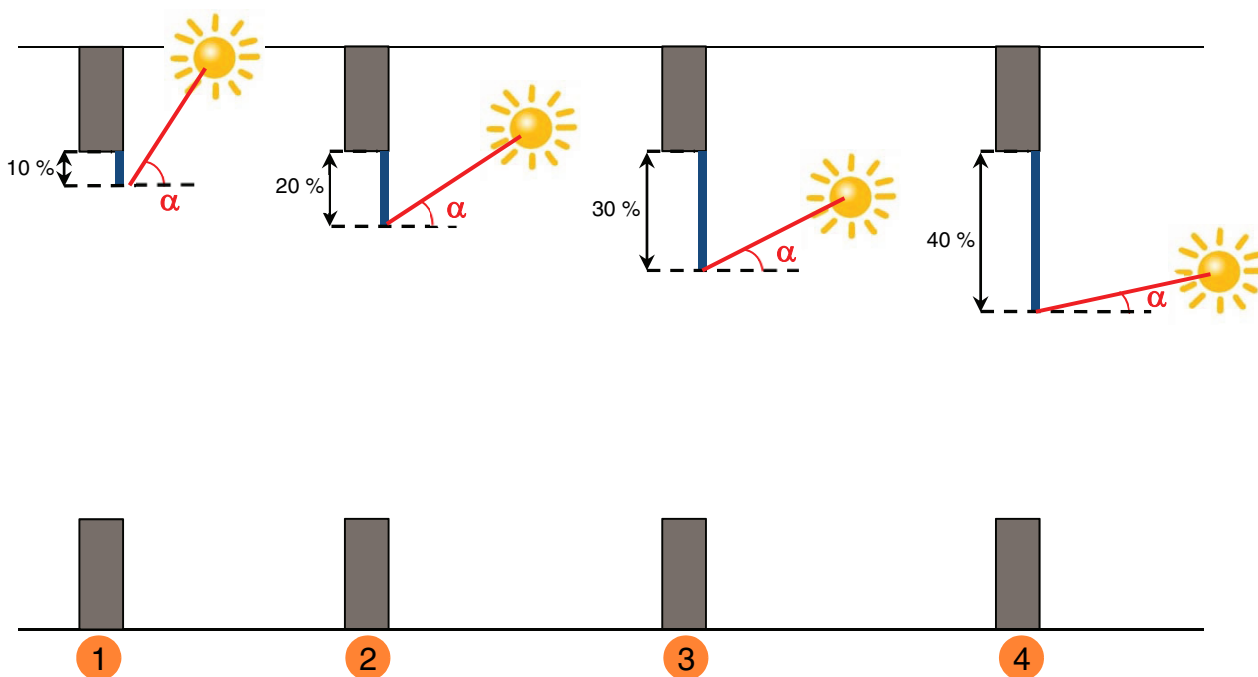

Example	Shutter position	Sun position - Angle α between
1	10%	46° ... 90°
2	20%	31° ... 45°
3	30%	16° ... 30°
4	40%	0° ... 15°

Sun protection operation for shutters:

If the luminosity level is sufficient (more than 40 Klux for more than one minute) **and** the sun is shining on the facade:

- The shutter is positioned in line with the path of the sun between x% closure and the maximum shading position defined by the configuration (20 to 80 %).

If the luminosity level is insufficient (less than 32 Klux for more than 15 minutes) **or** the sun is not shining on the facade:

- The shutter is positioned at a fixed value of 0 %.

Parameter	Description	Value
Max. position for facade x shading	This setting defines the maximum permitted closure for automatic shading control.	20...80 %*

x = 1 to 4

*Note: The value of this parameter is taken into account only when the **Facade shading x** parameter has the value: **Position**.*

* Default value

Shading with slat blinds

During slat adjustment, the horizontal slats of the blinds are not fully closed; rather they are matched to the sun condition and set automatically in such a way that the sun cannot shine directly into the room.

However diffuse daylight can enter the room between the slats and so provide glare-free room lighting. Slat adjustment of an external blind prevents the entry of heat from sunshine into the room and, at the same time, reduces the cost of electricity for room lighting.

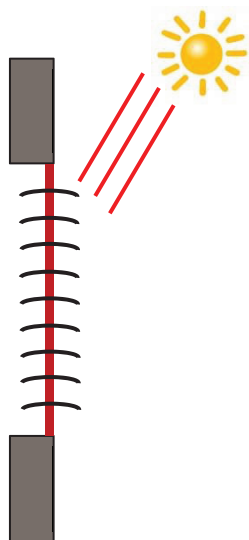

Sun protection at high sun elevations

Shading is automatically controlled if the shading conditions on the relevant facade are fulfilled: luminosity threshold > 40 klux and sun on the facade. To limit the number of trips, the shading starts by fully lowering the blinds following the direction of the slats at 50 %.

The low position will be maintained as long as the shading function is activated, and adjustments are made simply by orienting the slats depending on the position of the sun.

The slats are positioned almost horizontally, so that the sun does not directly penetrate the room.

Position: 100 %
Tilt tracking: 50 %

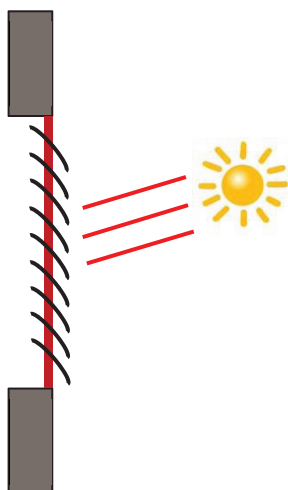

Sun protection at medium sun elevations

The low position is maintained and the slats are re-closed a little more to prevent sunlight from directly entering the room.

Diffuse daylight, however, can still continue to enter and so provide lighting for the room (daylight use).

Sun protection at low sun elevations

The slats are automatically closed to an extent where the sun cannot shine directly into the room.

Position: 100 %
Tilt tracking: 80 %

Sun protection operation for blinds:

If the luminosity level is sufficient (more than 40 Klux for more than one minute) **and** the sun is shining on the facade:

- The blind is positioned at the fixed value of 100 % (lower position).
- The blind is tilted at a value calculated by the weather station depending on the position of the sun.

If the luminosity level is insufficient (less than 32 klux for more than 10 minutes):

- The blind remains in the 100 % lowered position.
- The blind tilts the slats horizontally (50 % value).

If at the end of 30 minutes, the luminosity level is still insufficient (less than 32 Klux for more than 10 minutes) **or** the sun is not shining on the facade:

- The blind is positioned at the fixed value of 0 %.
- The blind tilts the slats at a fixed value of 0 %.

For sun protection using blinds, it is set at the lowest position (100%) while the shading function is activated. This limits positioning movements, so shading is carried out only by orienting the slats.

*Note: The value of the **Max. position for facade x shading** setting has no effect when the **Facade x shading** setting has the value: **0 to 180° tilt** or **90 to 180° tilt**.*

Value fixed by facade:

Parameter	Value
Luminosity threshold	40 Klux
Hysteresis of the luminosity threshold	- 8 Klux
Tilting in % after a slat control of 50%	50% (90°)
Tilting in % after a slat control of 100%	100% (180°)

■ Links

For this function, the link is established through configuration. This configuration positions the addresses of predefined groups for solar tracking.

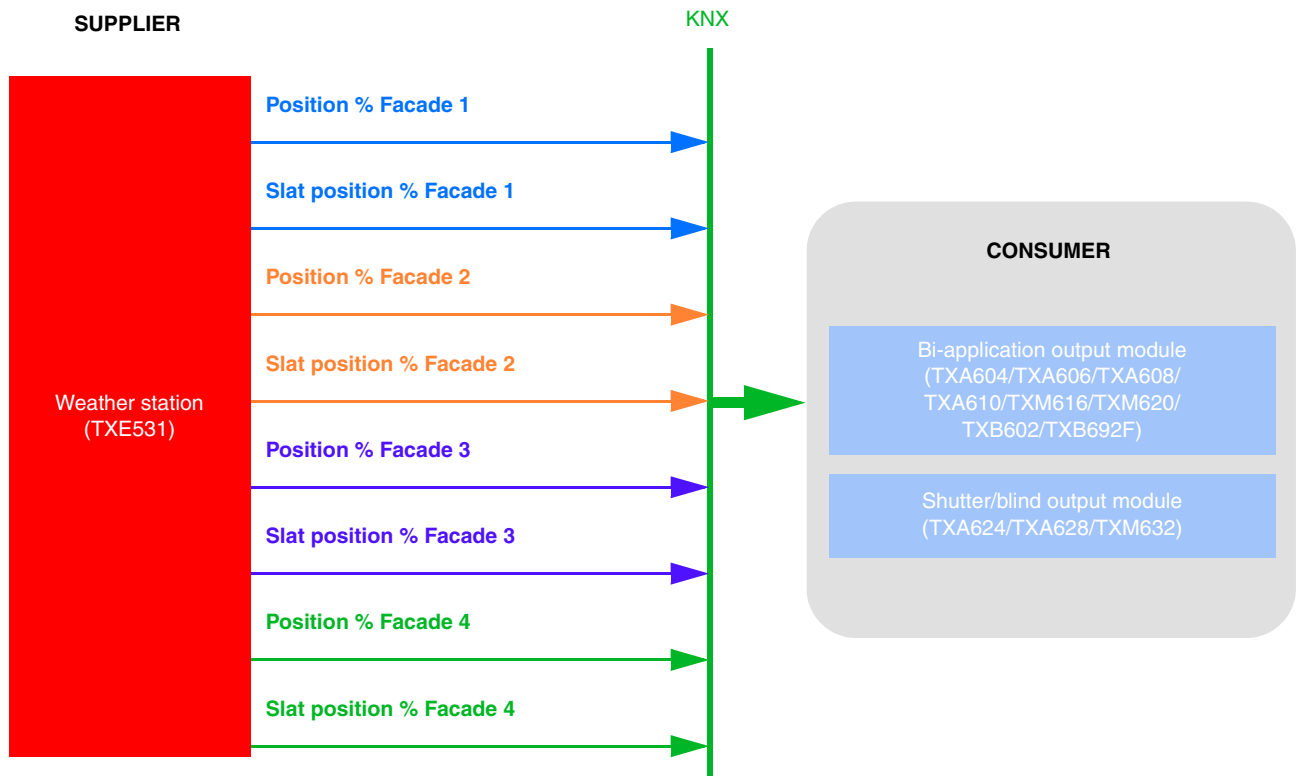

The configuration is established in 2 steps:

- On the weather station:

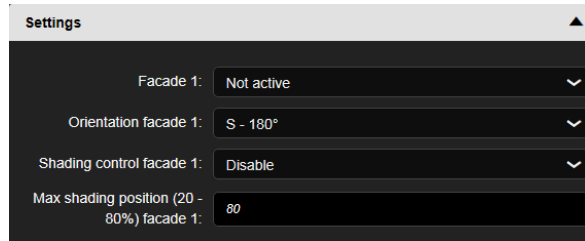

- Define the type of shading on the different facades (**Facade x**). This setting determines whether shading is established using the shutter position or the blind tilt.
Note: Operation is only provided for blinds with horizontal slats or rolling shutters.
 - Define the orientation of the different facades (**Facade orientation x**)
 - Define shading activation on the facade (**Shading facade x**)
 - Define the maximum shutter position for shading (20-80%) for each facade. This setting is only valid if shading is established using the shutter position.
- On the shutter output module:

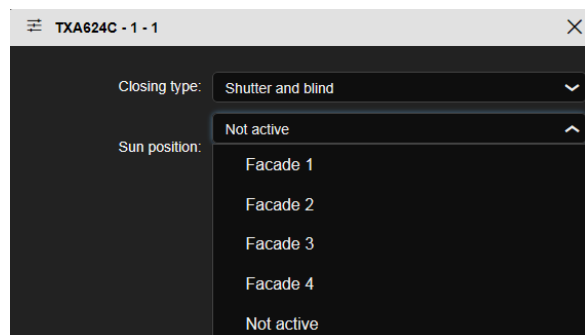

- Define on which facade the shutter is found. This setting triggers the shutter shading function.

- Another possible link:

Shading activation or deactivation can be established per facade by domovea using the weather station shutter device.

This can also be done using the push button, as shown below:

- **Automatic control deactivation:** Used to activate or deactivate shading facade 1.

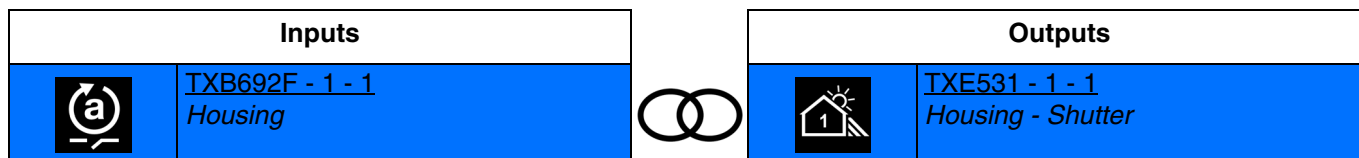

Closing input contact: Shading facade 1 deactivated

Opening input contact: Shading facade 1 activated

- **Automatic control deactivation toggle:** Used to activate or deactivate shading facade 1 using a push-button.

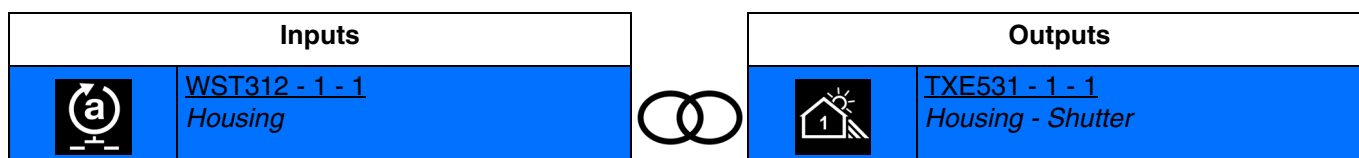

Press on the push-button: Switch between shading facade 1 activation and deactivation.

Successive closures reverse the shading facade 1 activation and deactivation status each time.

Note: This function is only available with push-button input products with LEDs indicating status.

Shading can be activated or deactivated on the 4 facades represented by the following symbols:

Facade 1	Facade 2	Facade 3	Facade 4

■ Group address

Position % Facade 1	30/0/016
Slat position % Facade 1	30/0/017
Position % Facade 2	30/0/018
Slat position % Facade 2	30/0/019
Position % Facade 3	30/0/020
Slat position % Facade 3	30/0/021
Position % Facade 4	30/0/022
Slat position % Facade 4	30/0/023

4.8 Heat protection/recovery

This function manages the indoor temperature according to sunlight and season. In summer, the heat protection allows for the blinds to be positioned so as to limit warming of the room.

In winter, heat recovery allows for the blinds to be positioned so as to reheat the room using sunlight, thus benefiting from a free heat source.

These two functions result in the full opening or closing of shutters or blinds.

Unlike shading, they will mainly be used when the room is empty.

these functions are valid on all the active facades.

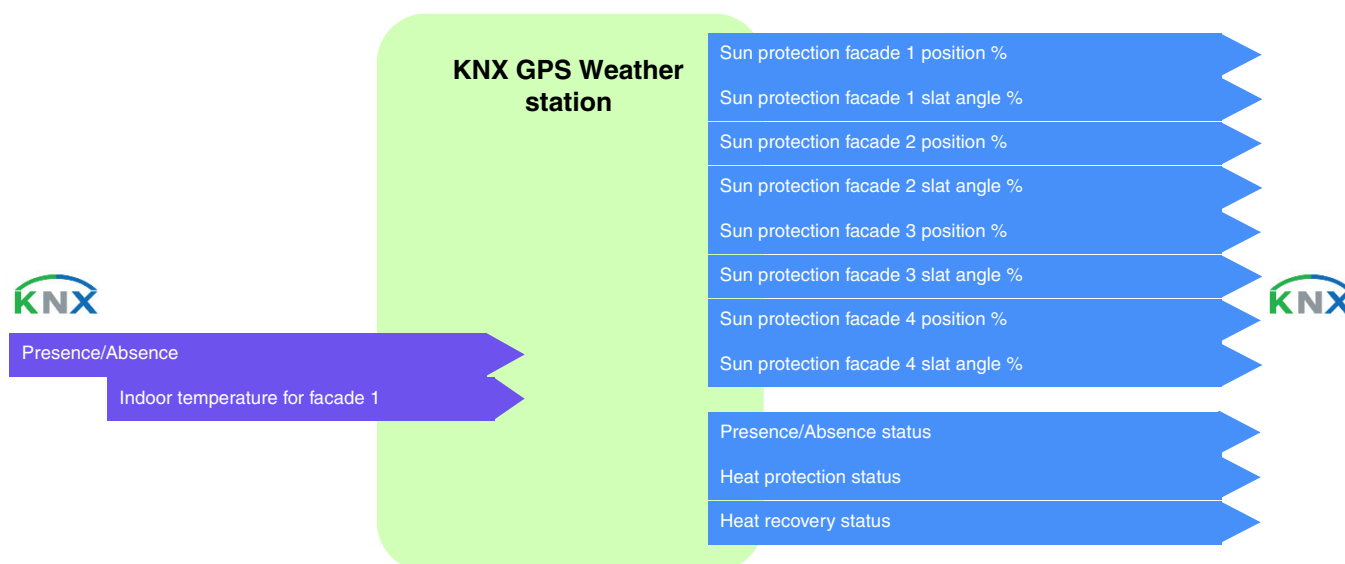

Heat protection

Heat protection is used to prevent the room from overheating and to limit the use of the air conditioning system.

It depends on:

- the luminosity on the facade (more than 40 klux)
- the position of the sun on the facade
- the outdoor temperature on all of the facades
- or the indoor temperature on the facade 1

Heat protection operation: (With the default values)

If the luminosity level is sufficient (more than 40 Klux for more than one minute) **and** the sun is shining on the facade **and** the outdoor temperature is greater than 30°C **or** the indoor temperature is greater than 26°C on the facade 1:

- The heat protection is activated. The shutters and blinds close completely. This function is prioritized on the shading control.

When heat protection or recovery is activated, at least one of the facades must be declared as active.

If the luminosity level is insufficient (less than 32 Klux for over 10 minutes) **or** the sun is not present on the facade **or** the outdoor temperature is lower than 24°C (= outdoor setpoint T° for heat protection - 6°C) **and** the indoor temperature is lower than 22°C for facade 1 for more than 15 minutes:

- The heat protection is deactivated. The shutters and blinds remain in position.

*Note: If the **Indoor temperature for facade 1** object does not receive a value, the indoor temperature is ignored and only the outdoor temperature is taken into account.*

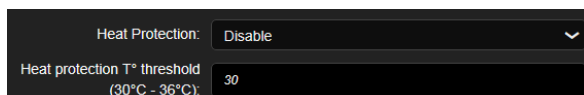

Parameter	Description	Value
Heat protection	The heat protection automatic control is: Locked-up Authorised	Not active* Active
Heat protection T° threshold	Used to define the outdoor temperature threshold value for heat protection.	28 ... 30* ... 36°C

Note: The heat protection status feedback is only used for domovea.

Heat recovery

To save energy, the heat recovery system contributes to heating up the room by using the sun's energy.

It depends on:

- the luminosity on the facade
- the position of the sun on the facade
- the outdoor temperature on all of the facades
- or the indoor temperature on the facade 1

Heat recovery operation: (With the default values)

If the luminosity level is sufficient (more than 40 Klux for more than one minute) **and** the sun is shining on the facade **and** the outdoor temperature is less than 12°C **and** the indoor temperature is less than 22°C for facade 1:

- Heat recovery is activated. The shutters and blinds open completely. **Warning:** This function should not be used for openings that are part of the anti-intrusion system.

If the luminosity level is insufficient (less than 32 Klux for over 10 minutes) **or** the sun is not present on the facade **or** the outdoor temperature is lower than 22°C (=outdoor T° setpoint for heat protection + 10°C) **and** the indoor temperature is higher than 26°C for facade 1:

- Heat recovery is disabled. The shutters and blinds close completely.

*Note: If the **Indoor temperature for facade 1** object does not receive a value, the indoor temperature is ignored and only the outdoor temperature is taken into account.*

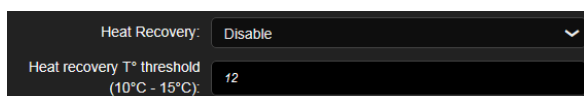

* Default value

Parameter	Description	Value
Heat recovery	Automatic control of heat recovery is: Locked-up Authorised	Not active* Active
Heat recovery T° threshold	Used to define the outdoor temperature threshold for heat recovery.	10 ... 12* ... 15°C

Note: The heat recovery status feedback is only used for domovea.

Automatic control		Temperature conditions		Result if all the conditions are met
		Outdoor temperature	Indoor temperature (If used)	
Heat protection	Activation	Outdoor temperature > threshold value with an adjustable threshold value of 28 to 36°C (Default value = 30°C)	Or Indoor temperature > 26°C	Closure of the shutters/blinds
	Deactivation	Outdoor temperature < threshold value - 6°C	And Indoor temperature < 22°C	Position of the shutters/blinds maintained or switch to shading function if selected and if all the conditions are met
Heat recovery	Activation	Outdoor temperature < threshold value with an adjustable threshold value of 10 to 15°C (Default value = 12°C)	And Indoor temperature < 22°C	Opening of the shutters/blinds
	Deactivation	Outdoor temperature > threshold value + 10°C	Or Indoor temperature > 26°C	Closure of the shutters/blinds or switch to shading function if selected and if all the conditions are met

* Default value

■ Links

For this function, the link is established through configuration. This setting positions the addresses of predefined groups for heat protection/recovery.

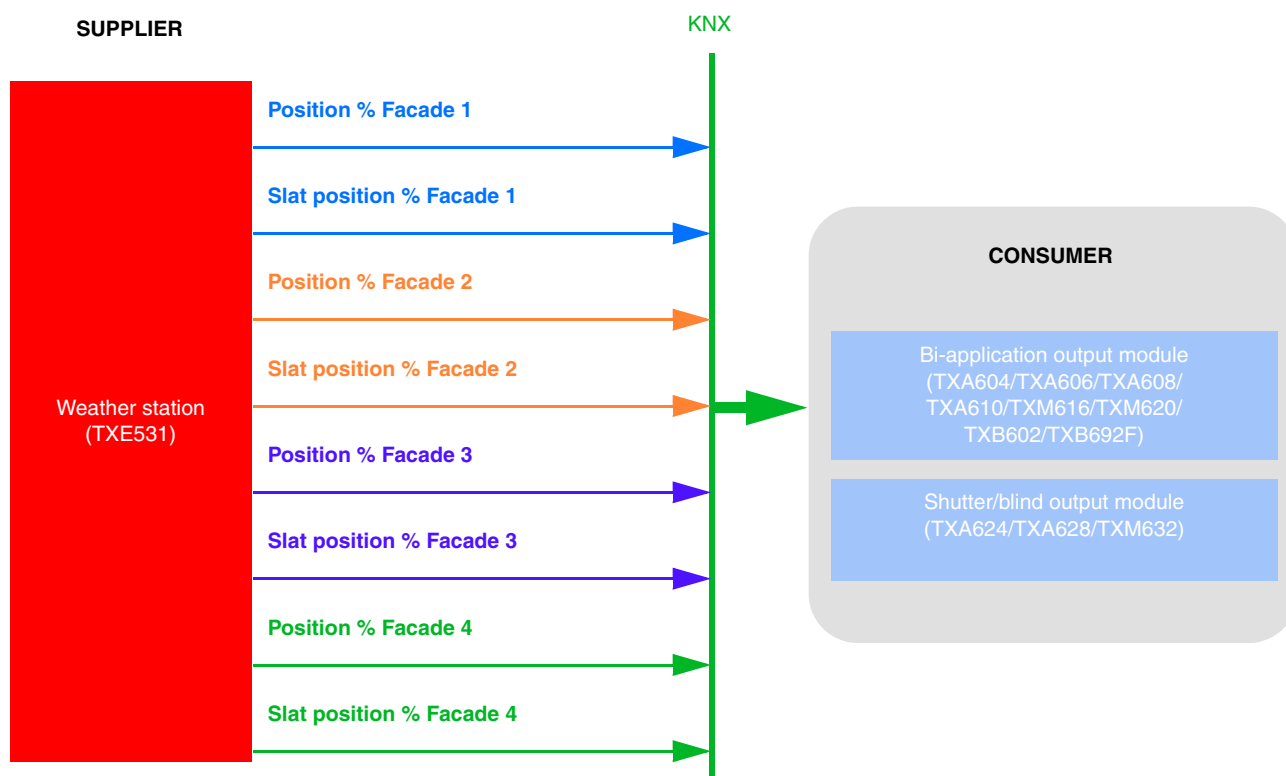

The setting is established on the weather station:



- Activate the heat protection and/or heat recovery.
- Define the temperature thresholds.

A link must be created with the thermostat for the indoor temperature of facade 1.

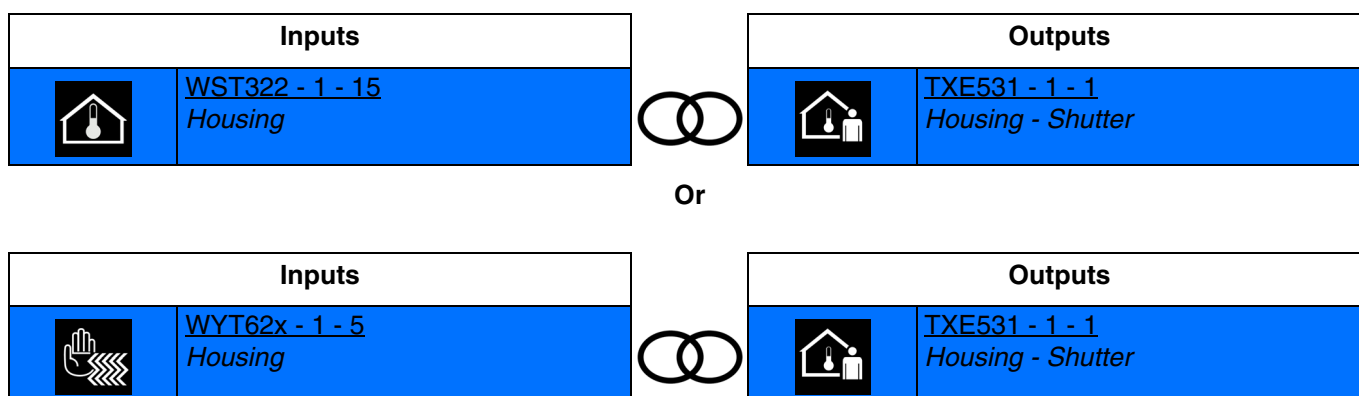

Note: This link is optional for this function.

- Another possible link:

The presence/absence function is active by default. Presence/absence can be activated or deactivated by Domovea using the weather station shutter device.

This can also be done using the push button, as shown below.

- **ON**: Used to notify the presence of the user.

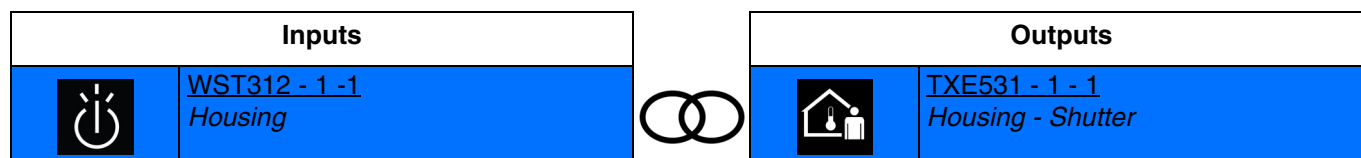

Closing input contact: User presence.

Opening input contact: No action.

- **OFF**: Used to notify the absence of the user.

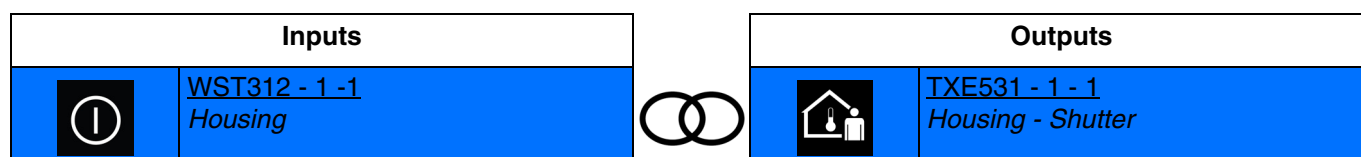

Closing input contact: User absence.

Opening input contact: No action.

- **ON/OFF**: Used to notify the presence and absence of the user (Switch).

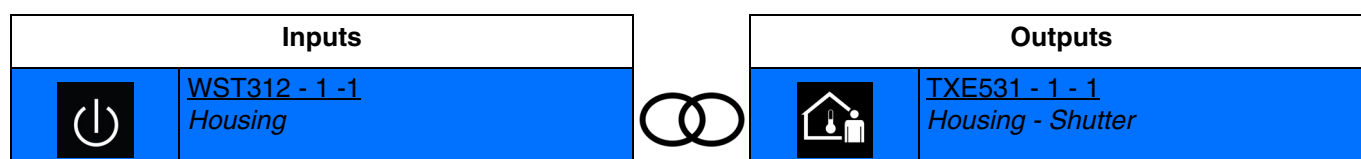

Closing input contact: User presence.

Opening input contact: User absence.

- **Toggle switch**: Used to reverse the user presence/absence status.

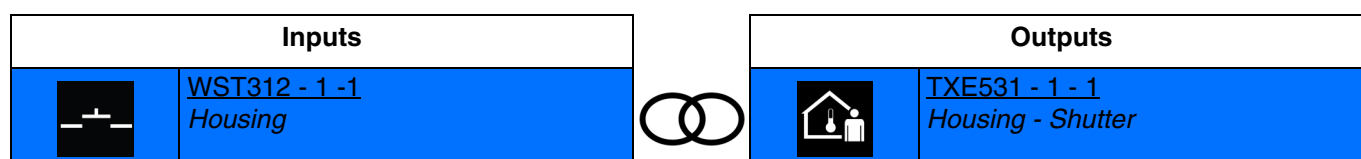

Closing input contact: Switch between user presence and absence.

Successive closures reverse the user presence and absence status each time.

Note: The use of push-button input products with LEDs for status indication is recommended for this function. Indicators are used to indicate the user's presence (LED on) or absence (LED off).

■ Group address

Position % Facade 1	30/0/016
Slat position % Facade 1	30/0/017
Position % Facade 2	30/0/018
Slat position % Facade 2	30/0/019
Position % Facade 3	30/0/020
Slat position % Facade 3	30/0/021
Position % Facade 4	30/0/022
Slat position % Facade 4	30/0/023

4.9 Export to domovea

The weather station is represented by 2 devices in domovea.

*Note: the compatible domovea software version must be version **3.6.1.0 or higher**.*

■ The weather data

The device is generated for export by checking the "Export to domovea" box in the input parameters. The information transmitted is shown below:

Objects	Group address
Luminosity	30/0/002
Rain	30/0/011
Temperature	30/0/000
Wind speed	30/0/001
Wind alarm 1	30/0/008
Temperature alarm	30/0/012
Day/night	30/0/003

■ The shading and shutter automation commands

The device is generated for export by checking the "Export to domovea" box in the output parameters. The information transmitted is shown below:

Objects
Shading monitoring - Facade 1
Shading monitoring - Facade 2
Shading monitoring - Facade 3
Shading monitoring - Facade 4
Shading monitoring indication - Facade 1
Shading monitoring indication - Facade 2
Shading monitoring indication - Facade 3
Shading monitoring indication - Facade 4
Presence/Absence
Presence/Absence indication
Heat protection indication
Heat recovery indication

Note: The group addresses of these objects are not fixed. They may vary according to the installation configuration.

5. Appendix

5.1 Specifications

Rated voltage KNX	DC 30 V
Current consumption KNX max.	6 mA
Auxiliary voltage	DC 12 ... 40 V TBTS AC 12 ... 24 V TBTS
Auxiliary current max.	185 mA - 12 V DC 80 mA - 24 V DC
Operating temperature	-30 ... +50 °C
Operating altitude max.	2000 m
Storage/transport temperature	-30 ... +70 °C
Conductor cross-section (rigid) max.	0,5 mm ²
Dimensions (W x H x D)	96 x 77 x 118 mm
Weight	170 g
Degree of protection	IP44
Surge voltage	1 500 V
Overvoltage category	III
Degree of contamination	2
Software class	A
Action type type	2
Ball test temperature	75 °C
Precipitation sensor:	
Measurement precipitation	1 bit
Heating	1,2W
Temperature sensor:	
Measuring range	-30 ... +80°C
Resolution	0,1 °C
Measuring accuracy	± 0,5 °C à +10 ... +50 °C ± 1 °C à -10 ... +85 °C ± 1,5 °C à -25 ... +150 °C
Wind sensor:	
Measuring range	0 ... 35 m/s
Resolution	0,1 m/s
Measuring accuracy ± 15% of measured value with an incidental flow from 90 ... 270 °	
Brightness/twilight sensor	
Cardinal direction South	
Measuring range	0 lx ... 150 klx
Measuring accuracy	± 20 % à 0 lx ... 10 klx ± 15 % à 10 ... 150 klx
Test mark KNX, CE	
Conformity according to EMC Directive 2004/108/EC, Low Voltage Directive 2006/95/EC	
Standards	EN 50491-3 EN 50491- 5 -2: 2011 EN 60730 - 1: 2011

5.2 Characteristics

Device	TXE531
Max. number of group addresses	254
Max. number of allocations	255
Objects	58

5.3 Index of objects

Outdoor temperature.....	42
Wind speed.....	42
Luminosity.....	42
Day/night.....	43
Rain alarm.....	43
Temperature alarm.....	44
Date slave.....	45
Time slave.....	45
Date and time slave.....	46
Date and time request.....	47
Sun protection facade 1 position %.....	50
Sun protection facade 1 slat angle %.....	51
Shading facade 1 deactivation.....	51
Shading deactivation status facade 1.....	51
Sun protection facade 2 position %.....	52
Sun protection facade 2 slat angle %.....	52
Shading facade 2 deactivation.....	52
Shading deactivation status facade 2.....	52
Sun protection facade 3 position %.....	52
Sun protection facade 3 slat angle %.....	52
Shading facade 3 deactivation.....	52
Shading deactivation status facade 3.....	53
Sun protection facade 4 position %.....	53
Sun protection facade 4 slat angle %.....	53
Shading facade 4 deactivation.....	53
Shading deactivation status facade 4.....	53
Presence/Absence.....	54
Presence/Absence status.....	54
Heat protection status.....	54
Heat recovery status.....	55
Indoor temperature for facade 1.....	55
Wind speed simulation.....	56
Luminosity simulation.....	56
Outdoor T° simulation.....	56
Rain simulation (1=rain).....	56
Indoor T° simulation.....	57
Shading facade 1 deactivation simulation.....	57
Shading facade 2 deactivation simulation.....	57
Shading facade 3 deactivation simulation.....	57
Shading facade 4 deactivation simulation.....	57
Presence/Absence simulation.....	58
Date simulation.....	58
Time simulation.....	59
Time and date simulation.....	60
Location: Northern latitude in °.....	61
Location: Eastern longitude in °.....	61
Location: Northern latitude + Eastern longitude in °.....	62
Simulation activation.....	62
Simulation value reset.....	63
Simulation activation status.....	63

