









	application software	
<ul style="list-style-type: none"> ▲ Manufacturers ▲ Hager Electro ▲ Outputs <ul style="list-style-type: none"> 2-outputs modules 4-outputs modules 6-outputs modules 8-outputs modules 10-outputs modules 16-outputs modules 20-outputs modules 	<p style="font-size: 24px; font-weight: bold;">2 - 4 - 6 - 8 - 10 - 16 - 20 switch actuator</p> <p><i>Electrical/Mechanical characteristics: see product user manual</i></p>	

	Product reference	Product designation	Application software ref	TP device	Radio device
	TYA604A	4-fold switch actuator 4A 230V AC	STYA604 1.x Version		
	TYA604B	4-fold switch actuator 10A 230V AC			
	TYA604C	4-fold switch actuator 16A 230V AC			
	TYA604D	4-fold switch actuator 16A C-load 230V AC			
	TYA606A	6-fold switch actuator 4A 230V AC	STYA606 1.x Version		
	TYA606B	6-fold switch actuator 10A 230V AC			
	TYA606C	6-fold switch actuator 16A 230V AC			
	TYA606D	6-fold switch actuator 16A C-load 230V AC			
	TYA608A	8-fold switch actuator 4A 230V AC	STYA608 1.x Version		
	TYA608B	8-fold switch actuator 10A 230V AC			
	TYA608C	8-fold switch actuator 16A 230V AC			
	TYA608D	8-fold switch actuator 16A C-load 230V AC			
	TYA610A	10-fold switch actuator 4A 230V AC	STYA610 1.x Version		
	TYA610B	10-fold switch actuator 10A 230V AC			
	TYA610C	10-fold switch actuator 16A 230V AC			
	TYA610D	10-fold switch actuator 16A C-load 230V AC			

	Product reference	Product designation	Application software ref	TP device  Radio device 
	TYM616D	16-fold switch actuator 16A C-load 230V AC	STYM616D 1.x Version	
	TYM620D	20-fold switch actuator 16A C-load 230V AC	STYM620D 1.x Version	
	TYB602F	2-fold switch actuator 6A 230V AC, embedded	STYB602F 1.x Version	

Content

1. General	5
1.1 About this guide	5
1.2 About the program	5
1.2.1 ETS compatibility	5
1.2.2 Application descriptions	5
2. General Description	6
2.1 Installation of the device	6
2.1.1 Overview presentation	6
2.1.2 Description of the device	7
2.1.3 Physical addressing	8
2.2 Function modules of the application	9
2.2.1 ON/OFF	9
2.2.2 Shutter/blind	12
3. Parameters	15
3.1 Closing type for the outputs	15
3.2 Definition of the general parameters	16
3.2.1 Activation of manual mode: ON/OFF	17
3.2.2 Activation of the Status indication: ON/OFF	17
3.2.3 Activation of the logic blocks: ON/OFF	17
3.2.4 Status during bus power cut or download: ON/OFF	18
3.2.5 Super alarm: Shutter	18
3.2.6 Activation of manual mode: Shutter	19
3.2.7 Activation of the Status indication: Shutter	19
3.2.8 Activation of the logic blocks: Shutter	19
3.2.9 Status during bus power cut or download: Shutter	20
3.2.10 Restore ETS-Parameters	21
3.2.11 Activation of the Device diagnosis object	22
3.2.12 Parameters overwrite at next download	22
3.2.13 LED display	22
3.3 Super alarm	23
3.3.1 Duration activation and position	23
3.3.2 Super alarm status indication	25
3.4.2.3 Status indication manual mode	31
3.3.4 Position after super alarm	26
3.4 Manual mode	28
3.4.1 Manual mode: ON/OFF	28
3.4.2 Manual mode: Shutter	30
3.5 Status indication	33
3.5.1 Status indication ON/OFF	33
3.5.2 Status indication Shutter	35
3.6 Logic block	40
3.6.1 Logic block : ON/OFF	41
3.6.2 Logic block : Shutter	47
3.7 Diagnosis	54
3.8 Functions of each switch actuator	56
3.8.1 Function selection	56
3.8.2 ON/OFF timings function	62
3.8.3 Timer	66
3.8.4 Scene	70
3.8.5 Preset	73
3.8.6 Lock-up	78
3.8.7 Priority	83
3.8.8 Hours counter	85
3.9 Functions for each shutter/blind output	89
3.9.1 Function selection	91
3.9.2 Scene	98
3.9.3 Lock-up	101
3.9.4 Preset	106
3.9.5 Priority	111
3.9.6 Alarm	113
3.9.7 Sun protection	118
4. Communication objects	124
4.1 Communication objects General	124
4.1.1 Manual mode	125
4.1.2 Logic block	126
4.1.3 Super alarm	128
4.1.4 Behaviour of the device	128
4.1.5 Diagnosis	129

4.2 Output communication objects	130
4.2.1 ON/OFF.....	135
4.2.2 ON/OFF timings function.....	135
4.2.3 Status indication	136
4.2.4 Timer.....	136
4.2.5 Scene	137
4.2.6 Preset.....	138
4.2.7 Lock-up	139
4.2.8 Priority.....	140
4.2.9 Hours counter.....	141
4.3 Communication objects for each shutter/blind output.....	142
4.3.1 Control.....	147
4.3.2 Status indication.....	148
4.3.3 Scene	150
4.3.4 Preset.....	150
4.3.5 Lock-up	151
4.3.6 Priority	152
4.3.7 Alarm.....	153
4.3.8 Sun protection.....	154
5. Appendix.....	156
5.1 Specifications	156
5.2 Table of logical operations.....	160
5.3 Characteristics.....	160

1. General

1.1 About this guide

The purpose of this manual is to describe the operation and configuration of the KNX-devices using the ETS program. It consists of 4 parts:

- General information.
- Parameter description.
- Overview of KNX objects.
- Technical characteristics.

1.2 About the program

1.2.1 ETS compatibility

The application programs are compatible with ETS4 and ETS5. They can be downloaded from our website under the order number.

ETS Version	File extension of compatible files
ETS4 (V4.1.8 or higher)	*.knxprod
ETS5	*.knxprod

1.2.2 Application descriptions

Application	Product reference
STYA604	TYA604A/B/C/D
STYA606	TYA606A/B/C/D
STYA608	TYA608A/B/C/D
STYA610	TYA610A/B/C/D
STYM616D	TYM616D
STYM620D	TYM620D
STYB602F	TYB602F

2. General Description

2.1 Installation of the device

2.1.1 Overview presentation

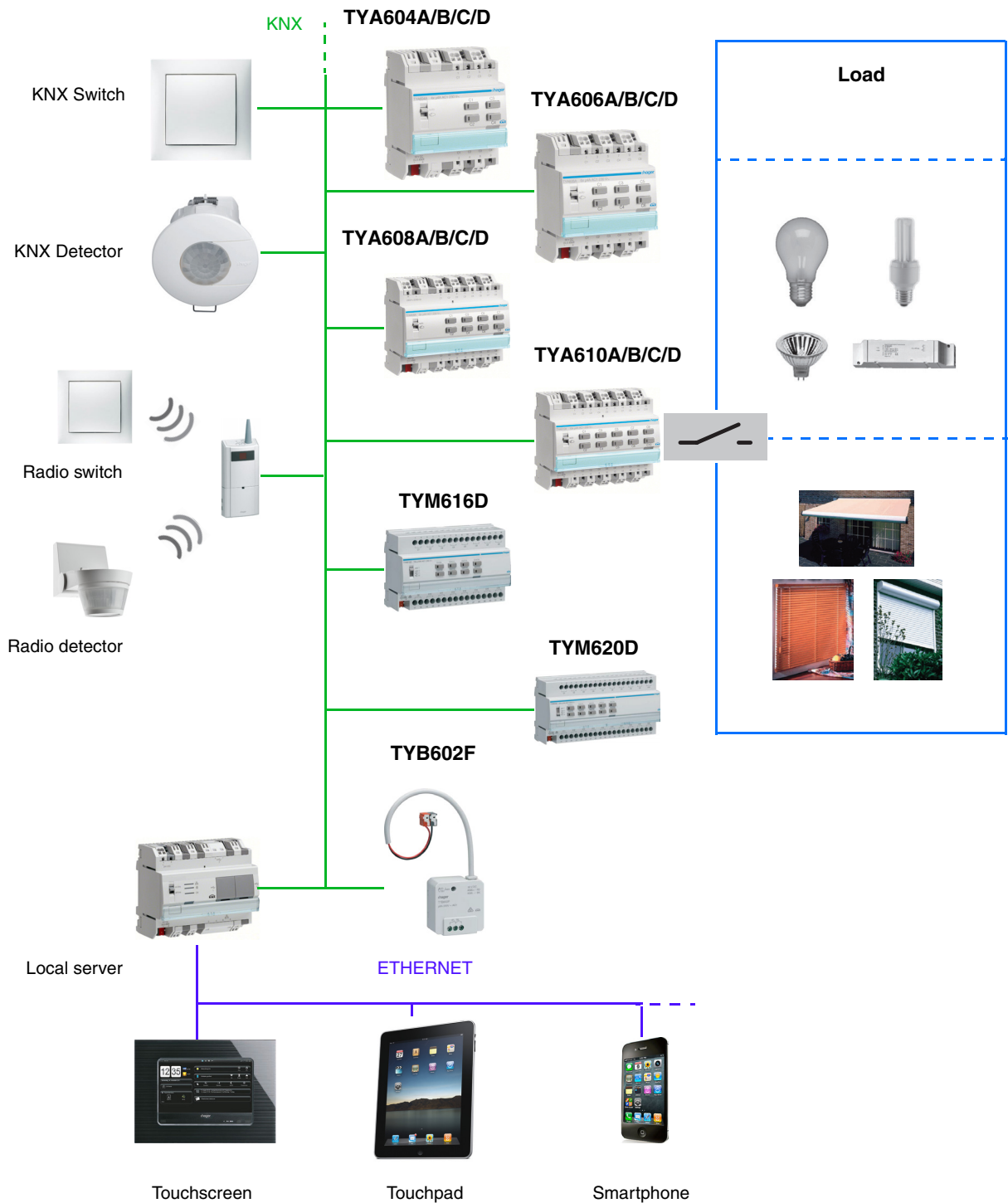

2.1.2 Description of the device

- TYB602F

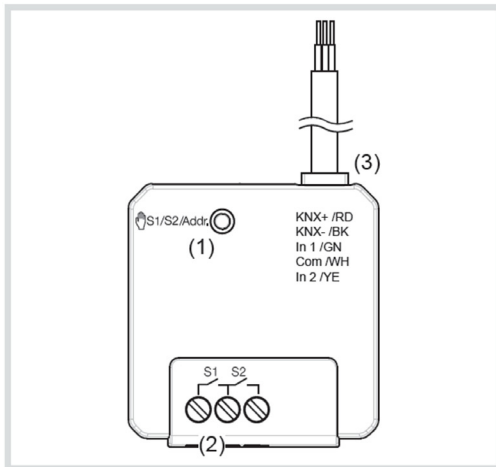

- (1) Illuminated button for manual operation/programming button
- (2) Connection of load(s)
- (3) KNX bus connection cable/construction inputs

- TYA6..A/B/C/D

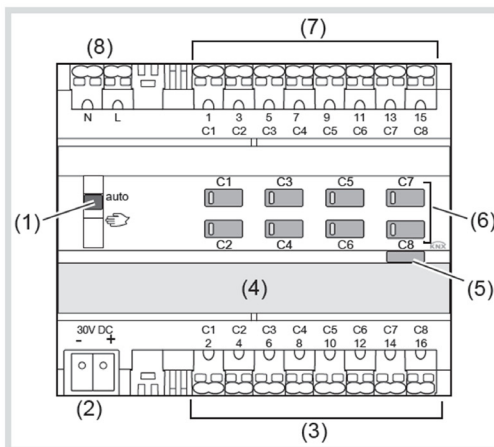

- (1) Slide switch **auto**
- (2) KNX bus connection terminal
- (3) Connections loads
- (4) Labelling field
- (5) Illuminated programming button
- (6) Operation button for manual operation per output with status LED
- (7) Connections for switching voltage
- (8) Mains power supply connections (only 8gang)

i With variants 4/2gang, 6/3gang and 10/5gang the basic design corresponds to the 8/4gang device variant.

- TYM6..D

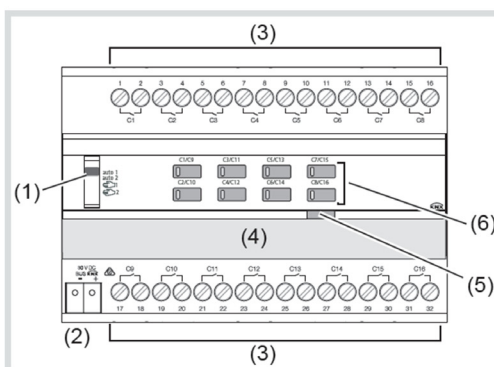

- (1) Slide switch **auto1/auto2**
- (2) KNX bus connection terminal
- (3) Connections of loads
- (4) Labelling field
- (5) Illuminated programming button
- (6) Operation button for manual operation for each pair of outputs with status LED

i With variants 20/10gang the basic design corresponds to the 16/8gang device variant.

auto1	Used to view outputs 1 to 8 (1 to 10) via the status LEDs.
auto2	Used to view outputs 9 to 16 (11 to 20) via the status LEDs.
	Used to control outputs 1 to 8 (1 to 10) via the manual control buttons.
	Used to control outputs 9 to 16 (11 to 20) via the manual control buttons.

2.1.3 Physical addressing

In order to perform the physical addressing or to check whether or not the bus is connected, press the lighted push button (1) (5) on the right-hand side above the identification plates on the front of the device.

Light on = bus connected and ready for physical addressing.

Programming mode is activated, until the physical address is transferred from ETS. Pressing the button again, exits programming mode. Physical addressing can be carried out in automatic or manual mode.

2.1.4 Connection

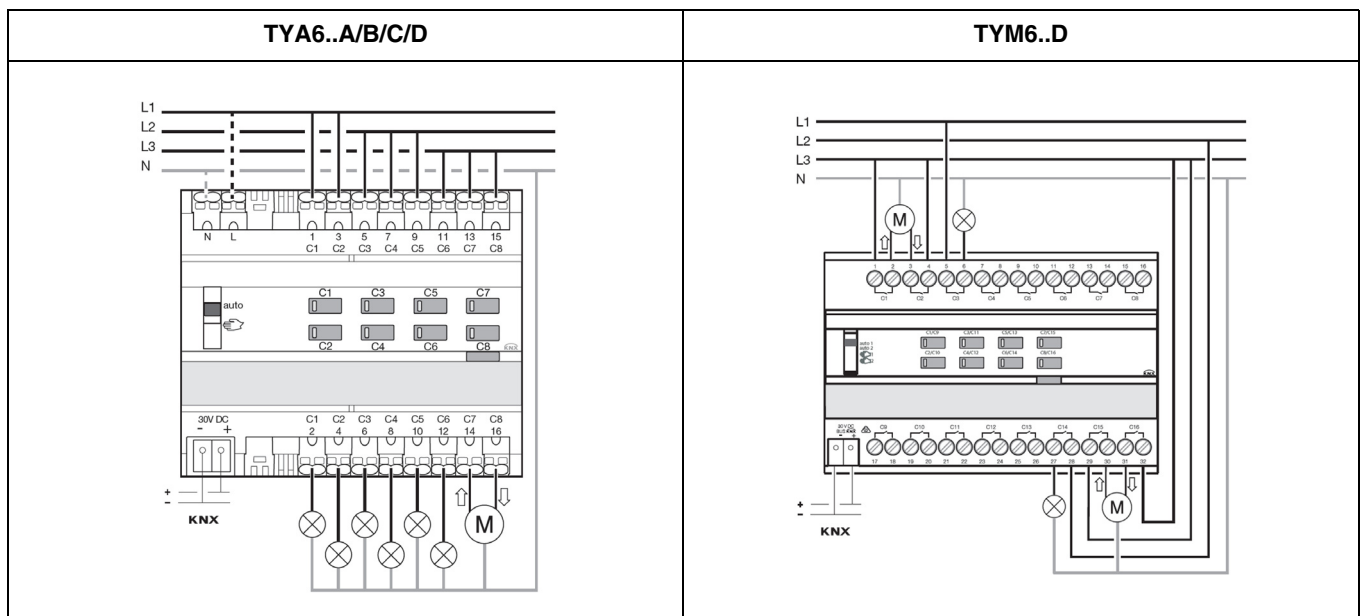
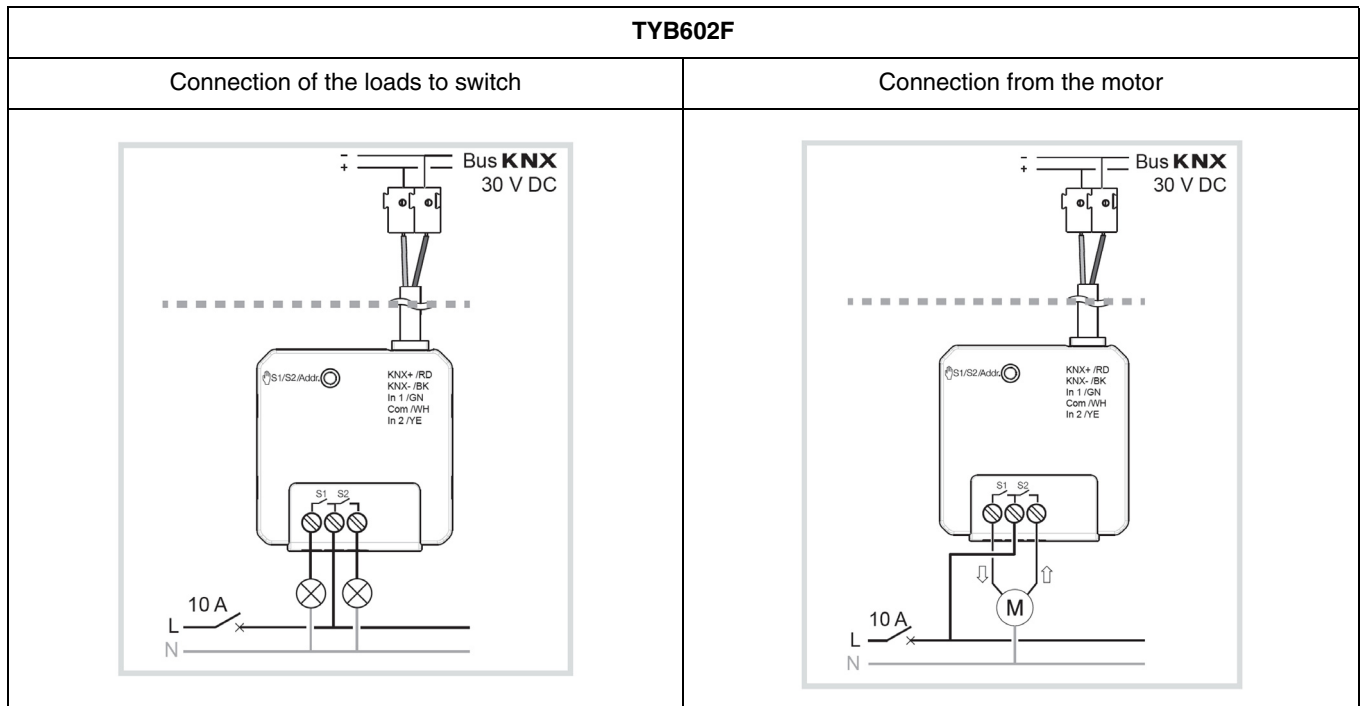

2.2 Function modules of the application

The switch actuators of the devices can be used in 2 different modes.

ON/OFF

- Each switching contact is used separately to switch a load.

Shutter/blind

- Each pair of outputs constitutes a shutter and blind channel.

A mix of the two operating modes is possible.



Warning: The devices are delivered in ON/OFF operating mode. When connecting shutters or blinds, ensure that both contacts are not turned on at the same time!

2.2.1 ON/OFF

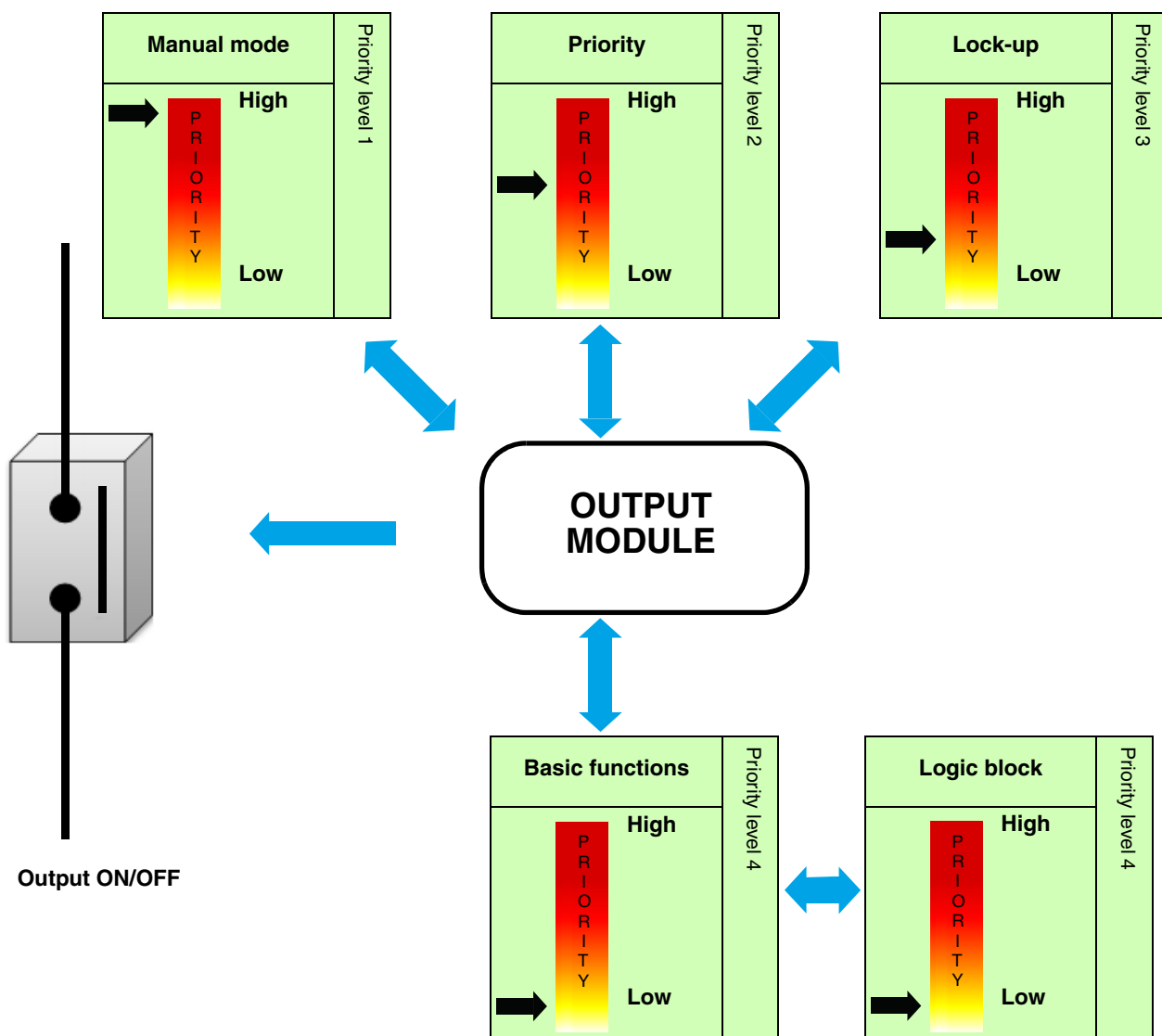

2.2.1.1 Functions for each switching channel

The applications allow individual configuration of the device outputs. The most important functions are:

■ ON/OFF

An output can be switched on or off using the ON/OFF function. The command can come from switches, buttons or other control inputs.

■ Timer

The Timer function is used to switch an output on or off for a programmable period. According to the selected operating mode of the timer, the output can be turned ON or OFF for a determined period of time. The timer may be interrupted before expiry of the delay time. A programmable Cut-OFF pre-warning announces the end of the delay time by a 1-second inversion of the output status. The timer duration can be modified via the bus KNX.

■ Time limited toggle switch

The Time-limited OFF function is a switching function that automatically switches off after a configurable delay time.

Application: Lighting of store rooms, cellars, sheds etc.

■ Priority

The Priority function is used to force the output into a defined state. The Priority function is controlled with a 2-bit command.

Priority: Manual mode > **Priority** > Lock-up > Basic function.

Only a Priority OFF command authorizes the output for control.

Application: Keeping lighting on for security reasons.

■ Lock-up

The Lock-up function is used to lock the output in a predefined state.

Priority: Manual mode > Priority > **Lock-up** > Basic function.

The Lock-up prevents actuation until an unlock command has been received. The Lock-up duration can be set.

■ Scene

The Scene function is used to switch groups of outputs into a configurable predefined state. A scene is activated by receipt of a 1-byte command. Each output can be included in 64 different scenes.

■ Preset

The Preset function is used to switch an output into various predefined states. The Preset function is activated via an object in 1-bit format. Each output can be controlled via 2 Preset objects.

■ Delay

The Delay functions are used to activate the outputs with a switching or tripping delay or with a switching and tripping delay.

■ Timer/toggle switch changeover

The Timer/toggle switch changeover function is used to switch between a Timer and a Toggle switch function applied to the communication object ON/OFF.

■ Hours counter

The Hours Counter function is used to count the overall operating time of an output in the ON or OFF state. The counter setpoint can be programmed and altered via an object.

2.2.1.2 Additional functions

The applications configure the general functions of the devices. The following functions apply to the entire device:

■ Manual mode

Manual mode allows the device to be disconnected from the bus. In this mode, each output can be priority controlled locally. This command has the highest priority. No other command is considered when manual mode is active. Only after ending manual mode are other types of control again permitted. The duration of the manual control can be configured. Manual mode can be locked-up via the KNX bus.

Note: Manual mode is not available with the 2 ON/OFF outputs module (TYB602F).

■ Status indication

The behaviour of the status indication of each switching channel can be configured for the entire device. The Status indication sends the switching status of the individual output contact on the KNX bus.

■ Logic block

The Logic function is used to control an output depending on the result of a logic operation. This command has the lowest priority. The result of the function can be output on the KNX bus and can directly control one or more outputs. There are 2 logic blocks per device with up to 4 inputs available.

■ Diagnosis

The Device diagnosis function allows notifications about the operating state of the device to be sent via the KNX bus. This information is sent periodically and/or on status change.

2.2.2 Shutter/blind

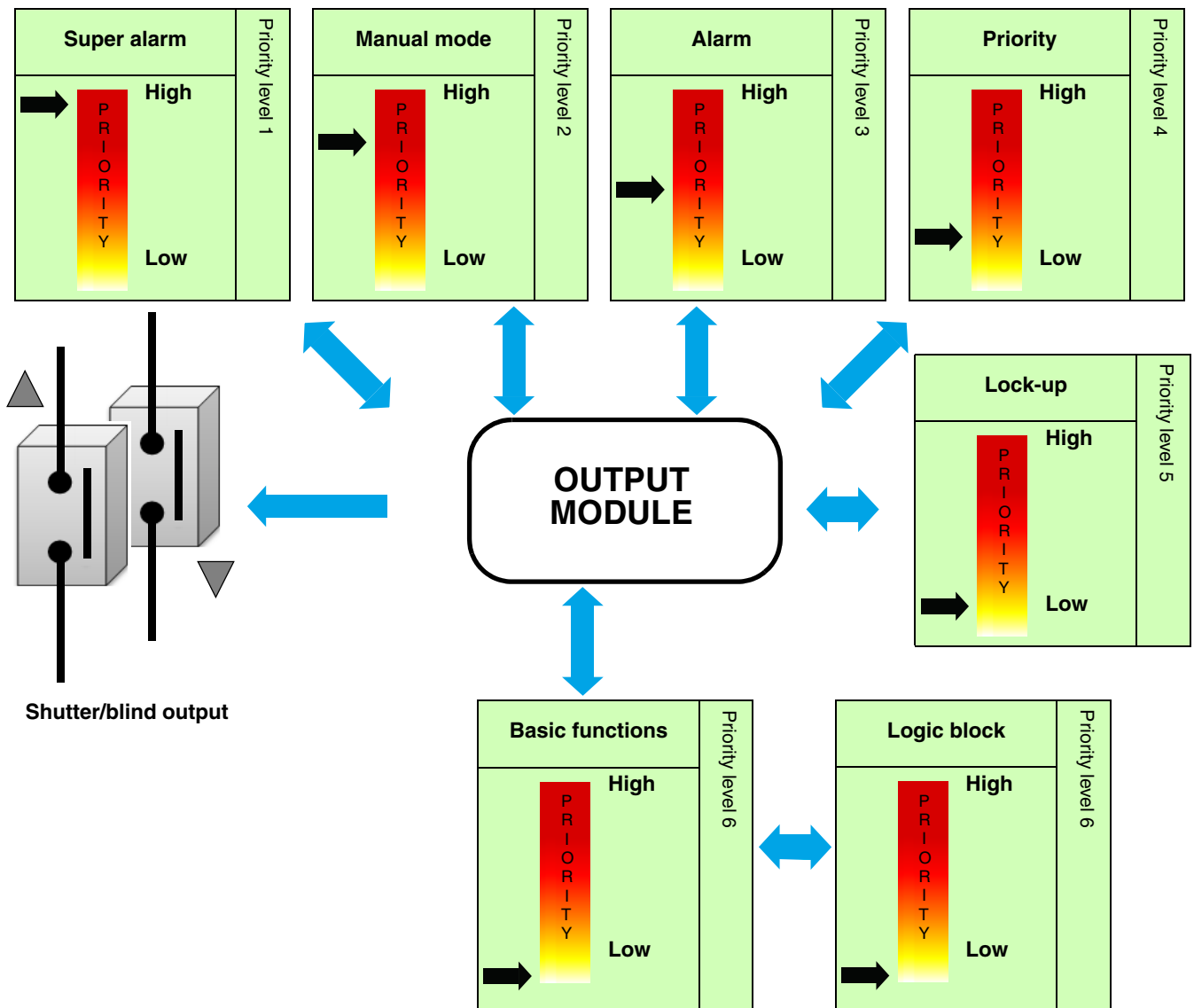

2.2.2.1 Functions for each shutter/blind channel

The applications allow individual configuration of the device outputs. The most important functions are:

■ Up/down

The UP/DOWN function is used to run up or down shutters, blinds, awnings, etc. This function can also be used to open and close electric blinds. The command can be given by touch sensors (long press), switches or automatically.

■ Slat position/Stop

The Slat position/Stop function is used to adjust the slats of a blind or to stop its ongoing movement. This function can be used to alter the shade and the incidence of light from outside. The control command may be issued by a push button, for example: A short press on UP/DOWN buttons.

■ Position in %

The Position function is used to bring a shutter or blind to a desired position, which is entered in % lock.

■ Scene

The Scene function is used to switch groups of outputs into a configurable predefined state. A scene is activated by receipt of a 1-byte command. Pressing a push button activates a scene. Each output can be included in 64 different scenes.

■ Preset

The Preset function is used to switch an output into various predefined states. The Preset function is activated via an object in 1-bit format.

■ Sun protection

The Sun protection function is used to set the brightness in a room according to the amount of daylight. In general, the position values are sent by an external device (For example, a weather station).

■ Lock-up

The Lock-up function is used to lock the output in a predefined state.

Priority: Super alarm > Manual mode > Alarm > Priority > **Lock-up** > Basic function.

The Lock-up prevents actuation until an unlock command has been received. The Lock-up duration can be set.

■ Priority

The Priority function is used to force the output into a defined state.

Priority: Super alarm > Manual mode > Alarm > **Priority** > Lock-up > Basic function.

Only a Priority OFF command authorizes the output for control.

Application: Maintaining a hanging position for security reasons.

■ Alarm

With the Alarm function a shutter or blind can be positioned in a configurable predefined state. Up to 3 alarm functions are possible.

Priority: Super alarm > Manual mode > **Alarm** > Priority > Lock-up > Basic function.

The alarm prevents any actuation until an alarm cancellation command has been received.

2.2.2.2 Additional functions

The applications configure the general functions of the devices. The following functions apply to the entire device:

■ Super alarm

This function is used to set all the outputs of the device into a configurable blocked state. All other functions, including manual mode, will be locked. Only a command to cancel the Super alarm will authorize the other commands.

Application: Block all blinds for window cleaning.

■ Manual mode

Manual mode allows the device to be disconnected from the bus. In this mode, each output can be priority controlled locally. The duration of the manual control can be configured.

Note: Manual mode is not available with the 2 ON/OFF outputs module (TYB602F).

■ Status indication

The behaviour of the Status indication of each shutter/blind channel can be configured for the entire device.

Using the Status indication function, the following can be sent via the bus:

- Position in % indication: Indicates the position of the shutter or blind.
- Slat angle indication in %: Indicates the slat pitch of the blind.
- Upper or lower position reached: Indicates arrival at the upper or lower position.

■ Logic block

The Logic function is used to control an output depending on the result of a logic operation. This command has the lowest priority. The result of the function can be output on the KNX bus and can directly control one or more outputs. There are 2 logic blocks per device with up to 4 inputs available.

■ Diagnosis

The Device diagnosis function allows notifications about the operating state of the device to be sent via the KNX bus. This information is sent periodically and/or on status change.

3. Parameters

3.1 Closing type for the outputs

This configuration window is used to set the Closing type for the outputs.
Parameter description:

ON/OFF

- Each switching contact is used separately to switch a load.

Shutter/blind

- Each pair of outputs constitutes a shutter and blind channel.

Device: 1.1.2 10-fold switch actuator 4A 230V AC

Outputs 1-10: Function selection	Function O1-O2	Shutter and blind
- O1-10: Manual mode ON/OFF	Function O3-O4	ON/OFF
- O1-10: Status indications ON/OFF	Function O5-O6	ON/OFF
Outputs 1-2: Function selection	Function O7-O8	ON/OFF
Output 3: Function selection	Function O9-O10	ON/OFF
Output 4: Function selection		
Output 5: Function selection		
Output 6: Function selection		
Output 7: Function selection		
Output 8: Function selection		
Output 9: Function selection		
Output 10: Function selection		
Information		

Parameter	Description	Value
Function Ox-Oy	The outputs are used as ON/OFF switches.	ON/OFF*
	The outputs are used for shutters and blinds. One output for raising and one output for lowering.	Shutter and blind

The assignment of the outputs is carried out following:

	ON/OFF	Shutter and blind
Function O1-O2	Output 1: ON/OFF Output 2: ON/OFF	Output 1-2: Shutter and blind
Function O3-O4	Output 3: ON/OFF Output 4: ON/OFF	Output 3-4: Shutter and blind
Function O5-O6	Output 5: ON/OFF Output 6: ON/OFF	Output 5-6: Shutter and blind
Function O7-O8	Output 7: ON/OFF Output 8: ON/OFF	Output 7-8: Shutter and blind
Function O9-O10	Output 9: ON/OFF Output 10: ON/OFF	Output 9-10: Shutter and blind

* Default value

3.2 Definition of the general parameters

This configuration window is used for general configuration of the device.

Device: 1.1.2 10-fold switch actuator 4A 230V AC

<ul style="list-style-type: none"> Outputs 1-10: Function Outputs 1-10: Function selection - O1-10: Manual mode ON/OFF - O1-10: Status indications ON/OFF Output 1: Function selection Output 2: Function selection Output 3: Function selection Output 4: Function selection Output 5: Function selection Output 6: Function selection Output 7: Function selection Output 8: Function selection Output 9: Function selection Output 10: Function selection Information 	<p>Function ON/OFF</p> <p>Manual mode <input type="text" value="Active"/></p> <p>Status indication <input type="text" value="Active"/></p> <p>Logic block 1 <input type="text" value="Not active"/></p> <p>Logic block 2 <input type="text" value="Not active"/></p> <p>Status during bus power cut <input type="text" value="Maintain status"/></p> <p>Status at bus return <input type="text" value="Maintain status"/></p> <p>Status after ETS download <input type="text" value="Maintain status"/></p> <p>Function shutter / blind</p> <p>Super alarm <input type="text" value="Not active"/></p> <p>Manual mode <input type="text" value="Not active"/></p> <p>Status indication <input type="text" value="Not active"/></p> <p>Logic block 1 <input type="text" value="Not active"/></p> <p>Logic block 2 <input type="text" value="Not active"/></p> <p>Status during bus power cut <input type="text" value="Maintain status"/></p> <p>Status after bus power cut <input type="text" value="Maintain status"/></p> <p>Status after ETS download <input type="text" value="Maintain status"/></p> <p>Common function</p> <p>Activ. of restore ETS-parameters object (scenes, timer, setpoints) <input type="text" value="Not active"/></p> <p>Device diagnosis object <input type="text" value="Not active"/></p> <p>Parameters overwrite at next download (scenes) <input type="text" value="Active"/></p> <p>Device LED switch off object <input type="text" value="Not active"/></p>
---	---

3.2.1 Activation of manual mode: ON/OFF

Parameter	Description	Value
Manual mode	Switching to manual mode is not possible.	Not active
	Switching to manual mode is possible without time limit.	Active*
	Manual mode can be activated for a duration that is configurable via the ETS parameters. After expiry of the time limit, manual mode is no longer active.	Time limited

For configuration see section: [Manual mode: ON/OFF](#).

Note: Manual mode is not available with the 2 ON/OFF outputs module (TYB602F).

3.2.2 Activation of the Status indication: ON/OFF

Parameter	Description	Value
Status indication	The Status indications parameter register is hidden.	Not active
	The Status indications parameter register is displayed.	Active*

For configuration see section: [Status indication ON/OFF](#).

3.2.3 Activation of the logic blocks: ON/OFF

Parameter	Description	Value
Logic block 1	Communication object and parameter register Logic block 1 are hidden.	Not active*
	Communication object and parameter register Logic block 1 are displayed.	Active

For configuration see section: [Logic block : ON/OFF](#).

Note: The parameters and objects are identical for block 2 ; Only the terms will be adjusted.

For logic block 1

Communication objects: **203 - Logic block 1 - Input 1** (1 bit - 1.002 DPT_Bool)
 207 - Logic block 1 - Logic result (1 bit - 1.002 DPT_Bool)

For logic block 2

Communication objects: **209 - Logic block 2 - Input 1** (1 bit - 1.002 DPT_Bool)
 213 - Logic block 2 - Logic result (1 bit - 1.002 DPT_Bool)

* Default value

3.2.4 Status during bus power cut or download: ON/OFF

Parameter	Description	Value
Status during bus power cut	The output status remains unchanged during a bus power cut.	Maintain status*
	The output is turned on when there is a bus power cut.	ON
	The output is turned off when there is a bus power cut.	OFF

Parameter	Description	Value
Status at bus return	The output status remains unchanged during at bus return.	Maintain status*
	The output is switched on at bus return.	ON
	The output is switched off at bus return.	OFF

Note: The device will reboot on bus return. The Priority functions that were present before the bus power cut, are no longer active (Priority, Lock-up).

Parameter	Description	Value
Status after ETS download	The output status remains unchanged after ETS download.	Maintain status*
	The output is switched on after ETS download.	ON
	The output is switched off after ETS download.	OFF

Note: During ETS-parameters download, the outputs remain unchanged.

3.2.5 Super alarm: Shutter

Parameter	Description	Value
Super alarm	Activation of the Super alarm is not possible.	Not active
	Activation of the Super alarm is possible without time limit.	Active*
	The Super alarm can be activated for a duration that is configurable via the ETS parameters.	Time limited
	After expiry of the time limit, the Super alarm is no longer active.	

Communication objects: [214 - Outputs 1-10 - Super alarm \(1 bit - 1.005 DPT_Alarm\)](#)

For configuration see section: [Super alarm](#).

* Default value

3.2.6 Activation of manual mode: Shutter

Parameter	Description	Value
Manual mode	Switching to manual mode is not possible.	Not active*
	Switching to manual mode is possible without time limit.	Active
	Manual mode can be activated for a duration that is configurable via the ETS parameters. After expiry of the time limit, manual mode is no longer active.	Time limited

For configuration see section: [Manual mode: Shutter](#).

3.2.7 Activation of the Status indication: Shutter

Parameter	Description	Value
Status indication	The Status indications parameter register is hidden.	Not active
	The Status indications parameter register is displayed.	Active*

For configuration see section: [Status indication Shutter](#).

3.2.8 Activation of the logic blocks: Shutter

Parameter	Description	Value
Logic block 1	Communication object and parameter register Logic block 1 are hidden.	Not active*
	Communication object and parameter register Logic block 1 are displayed.	Active

For configuration see section: [Logic block : Shutter](#).

Note: The parameters and objects are identical for block 2 ; Only the terms will be adjusted.

For logic block 1

Communication objects: **219 - Logic block 1 - Input 1** (1 bit - 1.002 DPT_Bool)
 223 - Logic block 1 - Logic result (1 bit - 1.002 DPT_Bool)

For logic block 2

Communication objects: **225 - Logic block 2 - Input 1** (1 bit - 1.002 DPT_Bool)
 229 - Logic block 2 - Logic result (1 bit - 1.002 DPT_Bool)

* Default value

3.2.9 Status during bus power cut or download: Shutter

Parameter	Description	Value
Status during bus power cut	Maintain the position before the bus power cut. Shutter or blind open. Shutter or blind closed.	Maintain status* Up Down

Parameter	Description	Value
Status after bus power cut	Maintain the position before the bus power cut. Shutter or blind open. Shutter or blind closed. Run to a specific position.	Maintain status* Up Down Specific position

Note: The device will reboot on bus return. The priority functions that were present before the bus power cut, are no longer active (Super alarm, Alarm, Priority, Lock-up).

Parameter	Description	Value
Position after bus power cut	This parameter defines the position to run the shutter or blind to, after the KNXbus power cut.	0 ... 5* ... 100

*Note: This parameter is only visible if the **Status after bus power cut** parameter has the following value: **Specific position**.*

Parameter	Description	Value
Slat angle (0-100%)	This parameter defines the slat position of the blind that is set after a KNX bus power cut.	0 ... 5* ... 100

*Note: This parameter is only visible if the **Status after bus power cut** parameter has the following value: **Specific position**.*

Parameter	Description	Value
Status after ETS download	Maintain the position before download. Shutter or blind open. Shutter or blind closed. Run to a specific position.	Maintain status* Up Down Specific position

Note: During ETS-parameters download, the outputs remain unchanged.

Parameter	Description	Value
Position after download	This parameter defines the position to run the shutter or blind to, after download of the ETS parameters.	0 ... 5* ... 100

*Note: This parameter is only visible if the **Status after download** parameter has the following value: **Specific position**.*

Parameter	Description	Value
Slat angle (0-100%)	This parameter defines the slat position of the blind that is set after download of the ETS-parameters.	0 ... 5* ... 100

*Note: This parameter is only visible if the **Status after download** parameter has the following value: **Specific position**.*

* Default value

3.2.10 Restore ETS-Parameters

There are 2 types of parameters in the device:

- Parameters that can only be changed via ETS.
- Parameters that can be changed via ETS or via the KNX bus.

For parameters that can be changed via ETS and via the KNX bus, 2 values are stored in the device memory: The value corresponding to the ETS-parameter and the currently used value.

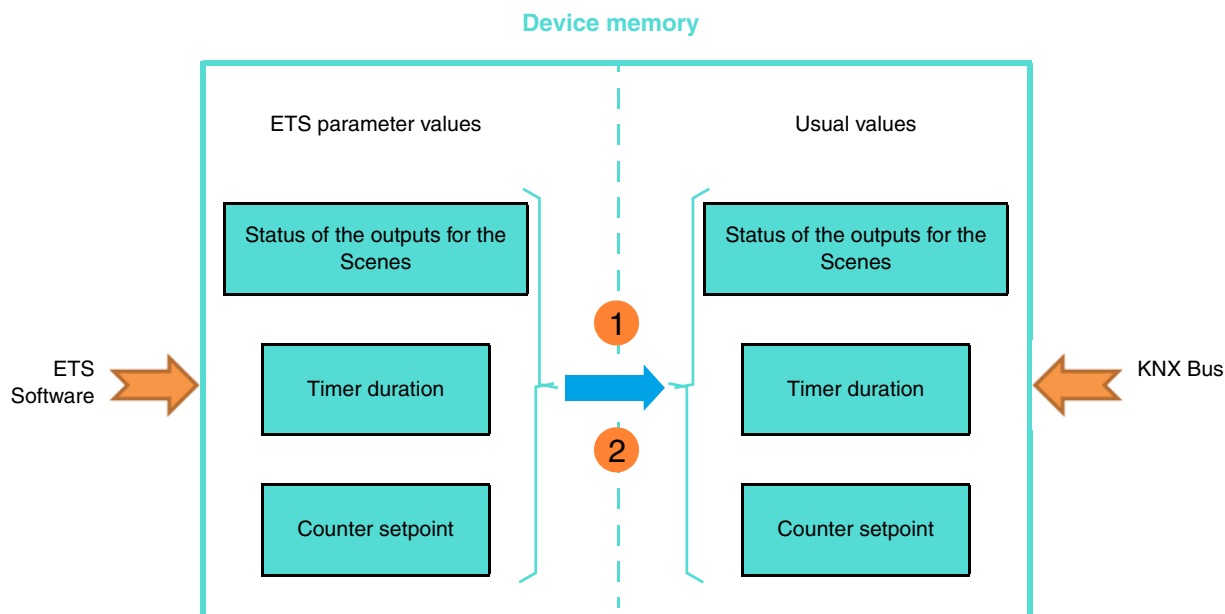

- 1 Receipt of the value 1 on the object, Resets the ETS parameter values:** Current parameter values are replaced by the ETS-parameter values.
- 2 Download of the ETS application:** Current parameter values are replaced by the ETS parameter values on download.

Parameter	Description	Value
Activ. of restore ETS-parameters object (scenes, timer, setpoints)	The Restore ETS-params settings communication object is hidden.	Not active*
	The Restore ETS-params settings communication object is displayed.	Active
	On receipt of a 1 on this object, the parameters** that are adjustable via the bus are overwritten with values set in the ETS before the last download.	

** Output status for scene X, Timer duration, Hours counter setpoint, Current setpoint 1 and 2, Counter value setpoint.

Communication object: [230 - Outputs 1-10 - Restore ETS-params settings \(1 bit - 1.015 DPT_Reset\)](#)

* Default value

3.2.11 Activation of the Device diagnosis object

Parameter	Description	Value
Device diagnosis object	The Device diagnosis parameter register and the associated communication object is hidden.	Not active*
	The Device diagnosis parameter register and the associated communication object are displayed.	Active

Communication object: [232 - Outputs 1-10 - Diagnosis \(6 byte - Specific\)](#)

For configuration see section: [Diagnosis](#).

3.2.12 Parameters overwrite at next download

Parameter	Description	Value
Parameters overwrite at next download (scenes)	The parameter values stored in the device will remain in the device at the next download.	Not active*
	The parameter values stored in the device will be overwritten with the ETS configured values at the next download.	Active

3.2.13 LED display

Parameter	Description	Value
Device LED switch off object	The Device LEDs lock-up communication object is hidden.	Not active*
	The Device LEDs lock-up communication object is displayed.	Active

This function is used to reduce the overall power consumption of the device. It allows the LEDs on the front of the device to be switched off.

Communication object: [231 - Outputs 1-10 - Device LED switch off \(1 bit - 1.001 DPT_Switch\)](#)

Parameter	Description	Value
Polarity	Object Device LED lock receives: 0 = The LED display is activated 1 = The LED display is deactivated 0 = The LED display is deactivated 1 = The LED display is activated	0 = Status indication, 1 = Always OFF* 0 = Always OFF, 1 = Status indication

*Note: This parameter is only visible if the parameter **Device LED switch off object** has the following value: **Active**.*

* Default value

3.3 Super alarm

This function is used to block all the outputs of the device in a configurable state. All other functions, including manual mode, will be locked. Only a command to cancel the Super alarm will authorize the other commands. The super alarm is activated on receipt of a 1 on the **Super alarm** communication object.

The behaviour is determined by the following parameters:

Device: 1.1.2 10-fold switch actuator 4A 230V AC

Outputs 1-10: Function selection

Outputs 1-10: Function selection

- O1-10: Super alarm shutter

- O1-10: Manual mode ON/OFF

- O1-10: Status indications ON/OFF

Outputs 1-2: Function selection

Output 3: Function selection

Output 4: Function selection

Output 5: Function selection

Output 6: Function selection

Output 7: Function selection

Output 8: Function selection

Output 9: Function selection

Output 10: Function selection

Information

WARNING!!!
The super alarm locks-up device functions, manual mode included

Duration of super alarm (h)

Duration of super alarm (min)

Duration of super alarm (s)

Position during super alarm

Super alarm status object

Polarity

Emission

Alarm monitoring period

Hours (h)

Minutes (min)

Seconds (s)

Position after super alarm

3.3.1 Duration activation and position

Parameter	Description	Value
Duration of super alarm	This parameter defines the time during which the super alarm is active.	12 hours: 0 to 23 h 0 minutes: 0 to 59 min 0 seconds: 0 to 59 s

Note: The smallest executable time is 1 second.

*Note: This parameter is only visible if the **Super alarm** parameter has the following value: **Time limited**.*

Parameter	Description	Value
Position during super alarm	During the super alarm, the shutter/blind output: Not changed. Closes the Up contact. Closes the down contact. Opens the 2 contacts. Runs to a specific position. Runs to a position set in a scene.	Maintain status* Up Down Stop Specific position Scene number

Parameter	Description	Value
Position (0-100%)	This parameter defines the position to run the shutter or blind to during the super alarm.	0 ... 5* ... 100

*Note: This parameter is only visible if the **Position during super alarm** parameter has the following value: **Specific position**.*

Parameter	Description	Value
Slat angle (0-100%)	This parameter defines the slat position of the blind that is set during the super alarm.	0 ... 5* ... 100

*Note: This parameter is only visible if the **Position during super alarm** parameter has the following value: **Specific position**.*

Parameter	Description	Value
Scene	This parameter defines the scene number that is to be applied during the super alarm.	Scene 1 ... 64 Default value: 1

The outputs respond according to the scene numbers and associated parameters.

*Note: This parameter is only visible if the **Position during super alarm** parameter has the following value: **Scene number**.*

* Default value

3.3.2 Super alarm status indication

Parameter	Description	Value
Super alarm status object	This parameter is used to authorize the Super alarm status object. This object allows the status of the super alarm to be sent from the device on the KNX bus.	Not active* Active

Communication object: [215 - Outputs 1-10: Shutter - Super alarm status \(1 bit - 1.011 DPT_State\)](#)

Parameter	Description	Value
Polarity	The Super alarm status object sends: 0 = When the super alarm is deactivated 1 = When the super alarm is activated 0 = When the super alarm is activated 1 = When the super alarm is deactivated	0 = Not active, 1 = Active* 0 = Active, 1 = Not active

*Note: This parameter is only visible if the **Super alarm status indication object** parameter has the following value: **Active**.*

Parameter	Description	Value
Emission	The object Super alarm status will be sent on: Activation or deactivation of the super alarm. Periodically after a configurable time. On activation or deactivation of the super alarm and periodically.	On status change* Periodically On status change and periodically

*Note: This parameter is only visible if the **Super alarm status indication object** parameter has the following value: **Active**.*

Parameter	Description	Value
Hours (h)	This parameter determines the time between the individual transmissions of the Super alarm status object.	0 hours: 0 to 23 h
Minutes (min)		10 minutes: 0 to 59 min
Seconds (s)		0 seconds: 0 to 59 s

Note: The smallest executable time is 1 second.

*Note: This parameter is only visible if the **Emission** parameter has the following value: **Periodically** or **On status change and periodically**.*

* Default value

3.3.3 Alarm monitoring period

Parameter	Description	Value
Alarm monitoring period	<p>The Super alarm object:</p> <p>Expects no periodic signal.</p> <p>Expects a periodic 0 signal.</p> <p>If this signal remains off, the super alarm is automatically activated and the shutters/blinds are run to the position set by the Position during super alarm parameter.</p>	<p>Not active*</p> <p>Active</p>

Parameter	Description	Value
Hours (h)	This parameter defines the maximum time between 2 signals on the Super alarm communication object.	0 hours: 0 to 23 h
Minutes (min)		10 minutes: 0 to 59 min
Seconds (s)		0 seconds: 0 to 59 s

Note: The smallest executable time is 1 second.

Note: This parameter is only visible if the **Alarm monitoring period** parameter has the following value: **Active**.

3.3.4 Position after super alarm

Parameter	Description	Value
Position after super alarm	<p>After the super alarm, the shutter/blind output:</p> <p>Not changed.</p> <p>Closes the Up contact.</p> <p>Closes the down contact.</p> <p>Runs to a specific position.</p> <p>Runs to a position set in a scene.</p> <p>Returns to the position before super alarm.</p> <p>Runs to the position that would be active according to other communication objects if no super alarm had taken place.</p>	<p>Maintain status*</p> <p>Up</p> <p>Down</p> <p>Specific position</p> <p>Scene number</p> <p>Position before super alarm</p> <p>Theoretical status without super alarm</p>

Note: On setting the **Theoretical status without super alarm**, the Up/Down and slat step commands are not saved.

Parameter	Description	Value
Position (0-100%)	This parameter defines the position to run the shutter or blind to after the super alarm.	0 ... 5* ... 100

Note: This parameter is only visible if the **Position after super alarm** parameter has the following value: **Specific position**.

* Default value

Parameter	Description	Value
Slat angle (0-100%)	This parameter defines the slat position that is to be applied after the super alarm.	0 ... 5* ... 100

*Note: This parameter is only visible if the **Position after super alarm** parameter has the following value: **Specific position**.*

Parameter	Description	Value
Scene	This parameter defines the scene number that is to be activated after the super alarm.	Scene 1 ... 64 Default value: 1

The outputs respond according to the scene numbers and associated parameters.

*Note: This parameter is only visible if the **Position after super alarm** parameter has the following value: **Scene number**.*

* Default value

3.4 Manual mode

In manual mode the device is disconnected from the KNX bus.

The function of the connected load can be checked using the manual mode button. Manual mode can only be activated using the switch on the front of the device. In this mode, telegrams arriving from the KNX bus are ignored.

When manual mode is activated, the status of the relays initially remains unchanged. Each time the manual mode button of an output is pressed, its status is switched over.

Note: Manual mode is not available with the 2 ON/OFF outputs module (TYB602F).

3.4.1 Manual mode: ON/OFF

The behaviour is determined by the following parameters:

Device: 1.1.2 10-fold switch actuator 4A 230V AC

- Outputs 1-10: Function
- Outputs 1-10: Function selection
- O1-10: Manual mode ON/OFF
- O1-10: Status indications ON/OFF
- Output 1: Function selection
- Output 2: Function selection
- Output 3: Function selection
- Output 4: Function selection
- Output 5: Function selection
- Output 6: Function selection
- Output 7: Function selection
- Output 8: Function selection
- Output 9: Function selection
- Output 10: Function selection
- Information

Duration of manual mode activation (h)	0
Duration of manual mode activation (min)	30
Duration of manual mode activation (s)	0
Object deactivation of manual mode	Active
Polarity	0=Manual mode authorized, 1=Manual mode locked-t
Object status indication manual mode	Active
Polarity	0=Manual mode deactivated, 1=Manual mode activat
Emission	On status change
Status after manual mode	Maintain status

3.4.1.1 Manual mode activation period

Parameter	Description	Value
Duration of manual mode activation	This parameter defines the amount of time for which manual mode remains activated.	0 hours: 0 to 23 h 30 minutes: 0 to 59 min 0 seconds: 0 to 59 s

Note: The smallest executable time is 1 second.

*Note: This parameter is only visible if the **Manual mode** parameter has the following value: **Time limited**.*

3.4.1.2 Deactivation of manual mode

Parameter	Description	Value
Object deactivation of manual mode	The Deactivation of manual mode communication object is hidden.	Not active*
	The Deactivation of manual mode communication object is displayed.	Active

Communication object: [200 - Outputs 1-10: ON/OFF - Deactivation of manual mode \(1 bit - 1.001 DPT_Switch\)](#)

Parameter	Description	Value
Polarity	The Deactivate manual mode object receives: 0 = Manual mode is activated 1 = Manual mode is not activated	0 = Manual mode authorized, 1 = Manual mode locked-up*
	0 = Manual mode is not activated 1 = Manual mode is activated	0 = Manual mode locked-up, 1 = Manual mode authorized

Note: This parameter is only visible if the **Object deactivation of manual mode** parameter has the following value: **Active**.

3.4.1.3 Status indication manual mode

Parameter	Description	Value
Object status indication manual mode	The Status indication manual mode communication object is hidden.	Not active*
	The Status indication manual mode communication object is displayed.	Active

Communication object: [201 - Outputs 1-10: ON/OFF - Status indication manual mode \(1 bit - 1.011 DPT_State\)](#)

Parameter	Description	Value
Polarity	The Status indication manual mode communication object sends: 0 = When manual mode is switched on 1 = When manual mode is switched off	0 = Manual mode active, 1 = Manual mode not active
	0 = When manual mode is switched off 1 = When manual mode is switched on	0 = Manual mode not active, 1 = Manual mode active*

Note: This parameter is only visible if the **Object status indication manual mode** parameter has the following value: **Active**.

Parameter	Description	Value
Emission	The Status indication manual mode communication object is sent: On switching manual mode on or off. Periodically after a configurable time.	On status change* Periodically
	On switching manual mode on or off and periodically after a configurable time.	On status change and periodically

Note: This parameter is only visible if the **Object status indication manual mode** parameter has the following value: **Active**.

* Default value

Parameter	Description	Value
Hours (h)	This parameter determines the time between the individual transmissions of the Status indication manual mode object.	0 hours: 0 to 23 h
Minutes (min)		10 minutes: 0 to 59 min
Seconds (s)		0 seconds: 0 to 59 s

Note: The smallest executable time is 1 second.

*Note: This parameter is only visible if the **Emission** parameter has the following value: **Periodically** or **On status change and periodically**.*

3.4.1.4 Status after manual mode

Parameter	Description	Value
Status after manual mode	At the end of manual mode, the output status is: Not changed. Is switched to the opposite status. Selectively switched on. Selectively switched off. Switched back to the status before manual mode was activated. Switched to the status which would be active according to other communication objects if the manual mode had not taken place.	Maintain status* Inversion ON OFF Status before manual mode Theoretical status without manual mode

Note: The application of this parameter depends on the priority of the other active functions. If a function with higher priority is active, this parameter will not be enacted. In the case where two functions with the same priority are active, the parameter of the most recently switched off function is enacted.

3.4.2 Manual mode: Shutter

The behaviour is determined by the following parameters:

Device: 1.1.2 10-fold switch actuator 4A 230V AC

<ul style="list-style-type: none"> Outputs 1-10: Function Outputs 1-10: Function selection - O1-10: Manual mode ON/OFF <li style="background-color: #e0e0e0;">- O1-10: Manual mode shutter - O1-10: Status indications ON/OFF Outputs 1-2: Function selection Output 3: Function selection Output 4: Function selection Output 5: Function selection Output 6: Function selection Output 7: Function selection Output 8: Function selection Output 9: Function selection Output 10: Function selection Information 	<p>Duration of manual mode activation (h) <input type="text" value="0"/></p> <p>Duration of manual mode activation (min) <input type="text" value="30"/></p> <p>Duration of manual mode activation (s) <input type="text" value="0"/></p> <p>Object deactivation of manual mode <input type="text" value="Active"/></p> <p>Polarity <input type="text" value="0=Manual mode authorized, 1=Manual mode locked-t"/></p> <p>Object status indication manual mode <input type="text" value="Active"/></p> <p>Polarity <input type="text" value="0=Manual mode deactivated, 1=Manual mode activat"/></p> <p>Emission <input type="text" value="On status change"/></p> <p>Position after manual mode <input type="text" value="Maintain status"/></p>
---	--

* Default value

3.4.2.1 Manual mode activation period

Parameter	Description	Value
Duration of manual mode activation	This parameter defines the amount of time for which manual mode remains activated.	0 hours: 0 to 23 h 30 minutes: 0 to 59 min 0 seconds: 0 to 59 s

Note: The smallest executable time is 1 second.

Note: This parameter is only visible if the **Manual mode** parameter has the following value: **Time limited**.

3.4.2.2 Deactivation of manual mode

Parameter	Description	Value
Object deactivation of manual mode	The Deactivation of manual mode communication object is hidden.	Not active*
	The Deactivation of manual mode communication object is displayed.	Active

Communication object: [216 - Outputs 1-10: Shutter - Deactivation of manual mode \(1 bit - 1.001 DPT_Switch\)](#)

Parameter	Description	Value
Polarity	The Deactivate manual mode object receives: 0 = Manual mode is activated 1 = Manual mode is not activated 0 = Manual mode is not activated 1 = Manual mode is activated	0 = Manual mode authorized, 1 = Manual mode locked-up* 0 = Manual mode locked-up, 1 = Manual mode authorized

Note: This parameter is only visible if the **Object deactivation of manual mode** parameter has the following value: **Active**.

3.4.2.3 Status indication manual mode

Parameter	Description	Value
Object status indication manual mode	The Status indication manual mode communication object is hidden.	Not active*
	The Status indication manual mode communication object is displayed.	Active

Communication object: [217 - Outputs 1-10: Shutter - Status indication manual mode \(1 bit - 1.011 DPT_State\)](#)

Parameter	Description	Value
Polarity	The Status indication manual mode communication object sends: 0 = When manual mode is switched on 1 = When manual mode is switched off 0 = When manual mode is switched off 1 = When manual mode is switched on	0 = Manual mode active, 1 = Manual mode not active 0 = Manual mode not active, 1 = Manual mode active*

Note: This parameter is only visible if the **Object status indication manual mode** parameter has the following value: **Active**.

* Default value

Parameter	Description	Value
Emission	The Status indication manual mode communication object is sent: On switching manual mode on or off. Periodically after a configurable time. On switching manual mode on or off and periodically after a configurable time.	On status change* Periodically On status change and periodically

Note: This parameter is only visible if the **Object status indication manual mode** parameter has the following value: **Active**.

Parameter	Description	Value
Hours (h)	This parameter determines the time between the individual transmissions of the Status indication manual mode object.	0 hours: 0 to 23 h
Minutes (min)		10 minutes: 0 to 59 min
Seconds (s)		0 seconds: 0 to 59 s

Note: The smallest executable time is 1 second.

Note: This parameter is only visible if the **Emission** parameter has the following value: **Periodically** or **On status change and periodically**.

3.4.2.4 Status after manual mode

Parameter	Description	Value
Status after manual mode	After manual mode, the shutter/blind output: Not changed. Closes the Up contact. Closes the down contact. Runs to a specific position. Returns to the position before super alarm. Runs to the position that would be active according to other communication objects if no super alarm had taken place.	Maintain status* Up Down Specific position Position before manual mode Theoretical status without manual mode

On setting the **Theoretical status without super alarm**, the Up/Down and slat step commands are not saved.

Parameter	Description	Value
Position (0-100%)	This parameter defines the position to run the shutter or blind to after manual mode.	0 ... 5* ... 100

Note: This parameter is only visible if the **Status after manual mode** parameter has the following value: **Specific position**.

Parameter	Description	Value
Slat angle (0-100%)	This parameter specifies the slat position of the blinds that is to be set after the end of manual mode.	0 ... 5* ... 100

Note: This parameter is only visible if the **Status after manual mode** parameter has the following value: **Specific position**.

* Default value

3.5 Status indication

The status Indication function specifies the status of the output contact.

3.5.1 Status indication ON/OFF

Device: 1.1.2 10-fold switch actuator 4A 230V AC

Outputs 1-10: Function selection	Polarity	0 = OFF, 1 = ON
Outputs 1-10: Function selection	Emission during manual mode	Active
- O1-10: Manual mode ON/OFF	Emission	On status change and periodically
- O1-10: Status indications ON/OFF	Hours (h)	0
Output 1: Function selection	Minutes (min)	10
Output 2: Function selection	Seconds (s)	0
Output 3: Function selection	Emission after bus power return (h)	0
Output 4: Function selection	Emission after bus power return (min)	0
Output 5: Function selection	Emission after bus power return (s)	20
Output 6: Function selection		
Output 7: Function selection		
Output 8: Function selection		
Output 9: Function selection		
Output 10: Function selection		
Information		

Parameter	Description	Value
Polarity	The Status indication ON/OFF communication object sends: 0 = For an open output contact 1 = For a closed output contact 0 = For a closed output contact 1 = For an open output contact	0 = OFF, 1 = ON* 0 = ON, 1 = OFF

*Note: If the Blinking function is activated, the above parameter is ignored and replaced by the **Output status during Blinking function** parameter.*

Parameter	Description	Value
Emission during manual mode	The Status indication ON/OFF communication object sends: Values if the output status is switched in manual mode. No values if the output status is switched in manual mode.	Active* Not active

Parameter	Description	Value
Emission	The Status indication ON/OFF communication object is sent: On each output change. Periodically after a configurable time. On output change and periodically after a configurable time.	On status change* Periodically On status change and periodically

* Default value

Parameter	Description	Value
Hours (h)	This parameter determines the time between the individual transmissions of the Status indication ON/OFF object.	0 hours: 0 to 23 h
Minutes (min)		10 minutes: 0 to 59 min
Seconds (s)		0 seconds: 0 to 59 s

Note: The smallest executable time is 1 second.

*Note: This parameter is only visible if the **Emission** parameter has the following value: **Periodically** or **On status change and periodically**.*

Parameter	Description	Value
Emission after bus power return	This parameter determines the delay for emission of the Status indication ON/OFF object on return of the KNX bus after a power cut.	0 hours: 0 to 23 h 0 minutes: 0 to 59 min 20 seconds: 0 to 59 s

Note: The smallest executable time is 1 second.

Note: This parameter can be used to optimize the bus load after the return of the KNX bus voltage.

3.5.2 Status indication Shutter

Using the Status indication function, the following can be sent via the bus:

- Position in % indication: Indicates the position of the shutter or blind.
- Slat angle indication in %: Indicates the slat pitch of the blind.
- Upper or lower position reached: Indicates that the shutter or blind has reached the upper or lower position.

The conditions for emission of the object values are on a change in the output, periodically or both of these simultaneously.

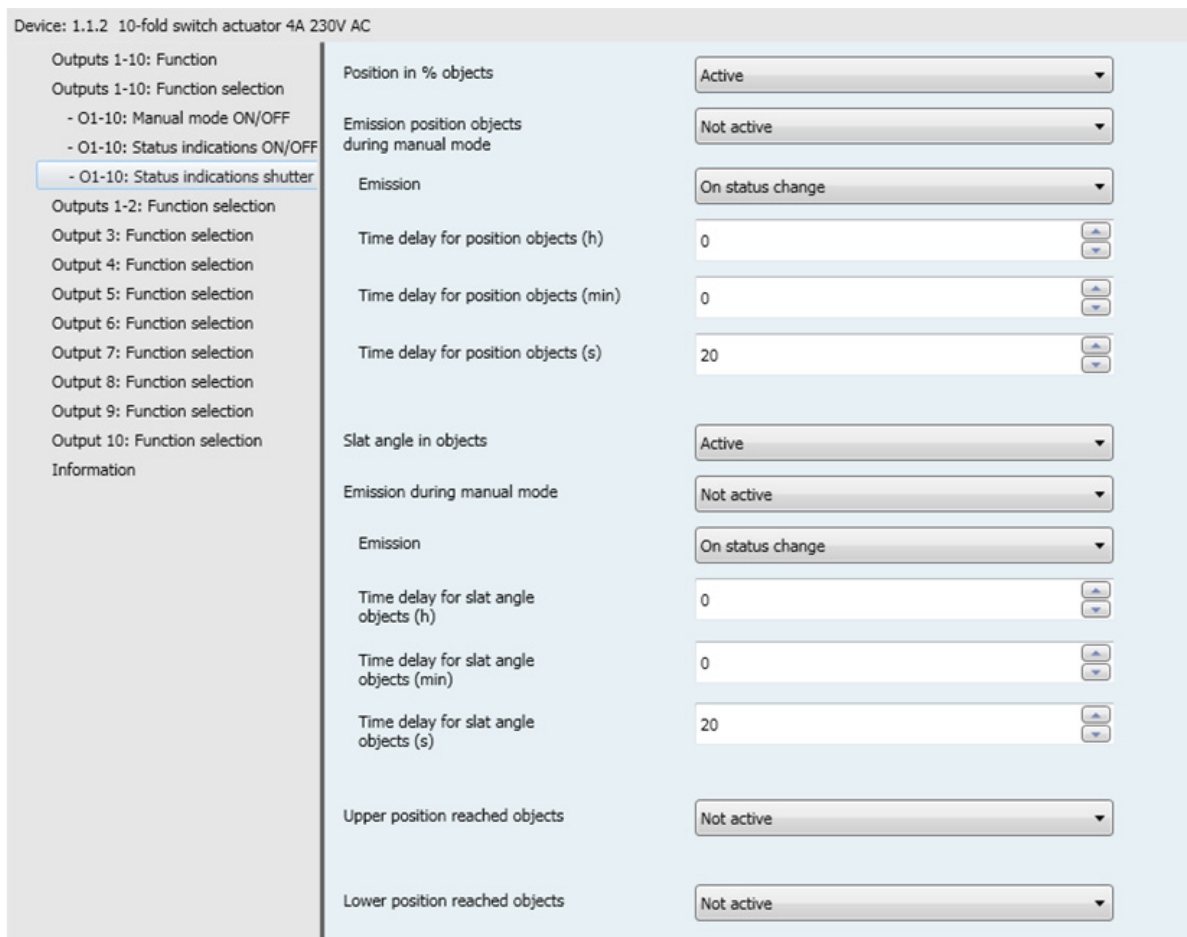

3.5.2.1 Position in % indication object

Parameter	Description	Value
Position in % objects	This parameter is used to display all the Position in % indication object related parameters.	Active* Not active

Parameter	Description	Value
Emission position objects during manual mode	The Position in % indication object sends: Values after a change of position in manual mode. No values after a change of position in manual mode.	Active Not active*

* Default value

Parameter	Description	Value
Emission	The Position in % indication communication object is sent: After each position change. Periodically after a configurable time. After a position change and periodically after a configurable time.	On status change* Periodically On status change and periodically

Parameter	Description	Value
Hours (h)	This parameter determines the time between the individual transmissions of the Position in % indication object.	0 hours: 0 to 23 h
Minutes (min)		30 minutes: 0 to 59 min
Seconds (s)		0 seconds: 0 to 59 s

Note: The smallest executable time is 1 second.

Note: This parameter is only visible if the **Emission** parameter has the following value: **Periodically** or **On status change and periodically**.

Parameter	Description	Value
Time delay for position objects	This parameter determines the delay for emission of the Position in % indication object on return of the KNX bus after a power cut.	1 hours: 0 to 23 h 0 minutes: 0 to 59 min 0 seconds: 0 to 59 s

Note: The smallest executable time is 1 second.

Note: This parameter can be used to optimize the bus load after the return of the KNX bus voltage.

3.5.2.2 Slat angle in % objects

Parameter	Description	Value
Slat angle in % objects	This parameter is used to display all the Slat angle indication in % object related parameters.	Active* Not active

Parameter	Description	Value
Emission during manual mode	The Slat angle indication in % object sends: Values after a change of position in manual mode. No values after a change of position in manual mode.	Active Not active*

Parameter	Description	Value
Emission	The Slat angle indication in % communication object is sent: After each position change. Periodically after a configurable time. After a position change and periodically after a configurable time.	On status change* Periodically On status change and periodically

* Default value

Parameter	Description	Value
Hours (h)	This parameter determines the time between the individual transmissions of the Slat angle indication in % objects.	0 hours: 0 to 23 h
Minutes (min)		30 minutes: 0 to 59 min
Seconds (s)		0 seconds: 0 to 59 s

Note: The smallest executable time is 1 second.

Note: This parameter is only visible if the **Emission** parameter has the following value: **Periodically** or **On status change and periodically**.

Parameter	Description	Value
Time delay for slat angle objects	This parameter determines the delay for emission of the Slat angle indication in % object on return of the KNX bus after a power cut.	0 hours: 0 to 23 h 0 minutes: 0 to 59 min 10 seconds: 0 to 59 s

Note: The smallest executable time is 1 second.

Note: This parameter can be used to optimize the bus load after the return of the KNX bus voltage.

3.5.2.3 Upper position reached object

Parameter	Description	Value
Upper position reached objects	This parameter is used to display all the Upper position reached object related parameters.	Active Not active*

Parameter	Description	Value
Polarity	The Upper position reached object sends: 0 on leaving the upper position 1 on reaching the upper position 0 on reaching the upper position 1 on leaving the upper position	0 = Position not reached, 1 = Position reached* 0 = Position reached, 1 = Position not reached

Parameter	Description	Value
Emission during manual mode	The Upper position reached object sends: Values on reaching the end position in manual mode. No values on reaching the end position in manual mode.	Active Not active*

Parameter	Description	Value
Emission	The Upper position reached object sends: On reaching or leaving the final position. Periodically after a configurable time. After a position change and periodically after a configurable time.	On status change* Periodically On status change and periodically

* Default value

Parameter	Description	Value
Hours (h)	This parameter determines the time between the individual transmissions of the Upper position reached object.	0 hours: 0 to 23 h
Minutes (min)		30 minutes: 0 to 59 min
Seconds (s)		0 seconds: 0 to 59 s

Note: The smallest executable time is 1 second.

Note: This parameter is only visible if the **Emission** parameter has the following value: **Periodically** or **On status change and periodically**.

Parameter	Description	Value
Time delay for upper position objects	This parameter determines the delay for emission of the Upper position reached object on return of the KNX bus after a power cut.	0 hours: 0 to 23 h 0 minutes: 0 to 59 min 20 seconds: 0 to 59 s

Note: The smallest executable time is 1 second.

Note: This parameter can be used to optimize the bus load after the return of the KNX bus voltage.

3.5.2.4 Lower position reached object

Parameter	Description	Value
Lower position reached objects	This parameter is used to display all the Lower position reached object related parameters.	Active Not active*

Parameter	Description	Value
Polarity	The Lower position reached object sends: 0 on leaving the lower position 1 on reaching the lower position 0 on reaching the lower position 1 on leaving the lower position	0 = Position not reached, 1 = Position reached* 0 = Position reached, 1 = Position not reached

Parameter	Description	Value
Emission during manual mode	The Lower position reached object sends: Values on reaching the end position in manual mode. No values on reaching the end position in manual mode.	Active Not active*

* Default value

Parameter	Description	Value
Emission	The Lower position reached communication object is sent: On reaching or leaving the final position. Periodically after a configurable time. After a position change and periodically after a configurable time.	On status change* Periodically On status change and periodically

Parameter	Description	Value
Hours (h)	This parameter determines the time between the individual transmissions of the Lower position reached object.	0 hours: 0 to 23 h
Minutes (min)		30 minutes: 0 to 59 min
Seconds (s)		0 seconds: 0 to 59 s

Note: The smallest executable time is 1 second.

*Note: This parameter is only visible if the **Emission** parameter has the following value: **Periodically** or **On status change and periodically**.*

Parameter	Description	Value
Time delay for lower position objects	This parameter determines the delay for emission of the Lower position reached object on return of the KNX bus after a power cut.	0 hours: 0 to 23 h 0 minutes: 0 to 59 min 20 seconds: 0 to 59 s

Note: The smallest executable time is 1 second.

Note: This parameter can be used to optimize the bus load after the return of the KNX bus voltage.

* Default value

3.6 Logic block

The Logic function is used to control an output depending on the result of a logic operation. This command has the lowest priority. The result of the function can be output on the KNX bus and may directly relate to the status of one or more outputs. 2 logic blocks are available for each device.

Operating principle of the logic block:

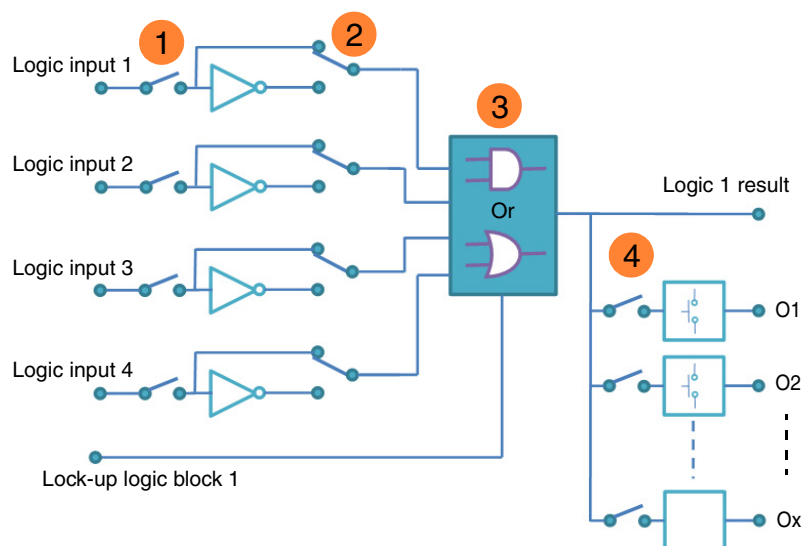

- ❶ Logic input number: Allows authorization of the logic input
- ❷ Logic input value: Inverted, yes or no
- ❸ Type of logic function (AND or OR): Selection of the logic function
- ❹ The logic result is applied to outputs: Selection of the outputs concerned by the logic operation

3.6.1 Logic block : ON/OFF

The behaviour is determined by the following parameters:

Note: The description of the parameters is given for logic block 1. The parameters and objects are identical for logic block 2 ; Only the terms will be adjusted.

Device: 1.1.2 10-fold switch actuator 4A 230V AC

Outputs 1-10: Function selection	Logic function type	OR
Outputs 1-10: Function selection	Number of logic input	1
- O1-10: Manual mode ON/OFF	Inverting value of logic input 1	Maintain status
- O1-10: Status indications ON/OFF	Value at initialization logic input 1	Value before initialization
- O1-10: Logic block 1 ON/OFF	Authorization object logic block	Not active
- O1-10: Logic block 2 ON/OFF	Emission of logic result	By logic result value change
Output 1: Function selection	Logic result acts on outputs	Active
Output 2: Function selection	Output 1	Yes
Output 3: Function selection	Output 2	Yes
Output 4: Function selection	Output 3	Yes
Output 5: Function selection	Output 4	Yes
Output 6: Function selection	Output 5	Yes
Output 7: Function selection	Output 6	Yes
Output 8: Function selection	Output 7	Yes
Output 9: Function selection	Output 8	Yes
Output 10: Function selection	Output 9	Yes
Information	Output 10	Yes
	Action if logic result = 0	OFF
	Action if logic result = 1	ON

3.6.1.1 Configuration of the Logic function

Parameter	Description	Value
Logic function type	The input objects are: OR linked. AND linked.	Or* And

For logic table see: [Appendix](#).

* Default value

Parameter	Description	Value
Number of logic inputs	This parameter determines the number of inputs of the logic block. Up to 4 inputs can be used.	1* 2 3 4

Communication objects:

Block 1 [204 - Logic block 1 - Input 2 \(1 bit - 1.002 DPT_Boot\)](#)
[205 - Logic block 1 - Input 3 \(1 bit - 1.002 DPT_Boot\)](#)
[206 - Logic block 1 - Input 4 \(1 bit - 1.002 DPT_Boot\)](#)

Block 2 [210 - Logic block 2 - Input 2 \(1 bit - 1.002 DPT_Boot\)](#)
[211 - Logic block 2 - Input 3 \(1 bit - 1.002 DPT_Boot\)](#)
[212 - Logic block 2 - Input 4 \(1 bit - 1.002 DPT_Boot\)](#)

Parameter	Description	Value
Inverting value of logic input x	The value of logic input x works on the logic block: With its object value (0=0, 1=1). With inverted object value (0=1, 1=0).	Maintain status* Status inversion

x = 1 to 4

Parameter	Description	Value
Value at initialization of logic input x	On initialization of the device after a download or after return of the bus power, the value of the logic input is: Set to 0. Set to 1. Set according to the value of the logic input before the initialization occurred.	0 1 Value before initialization*

x = 1 to 4

* Default value

3.6.1.2 Logic block authorization

Principle of logic block authorization:

The parameters are set as follows:

- Logic block authorization: 0 = Locked-up, 1 = Authorized.
- Action if logic result = 0 : Scene 1.
- Action if logic result = 1 : Scene 2.
- Logic input 1 and 2 are AND-linked.
- Emission of logic result: By input value change.

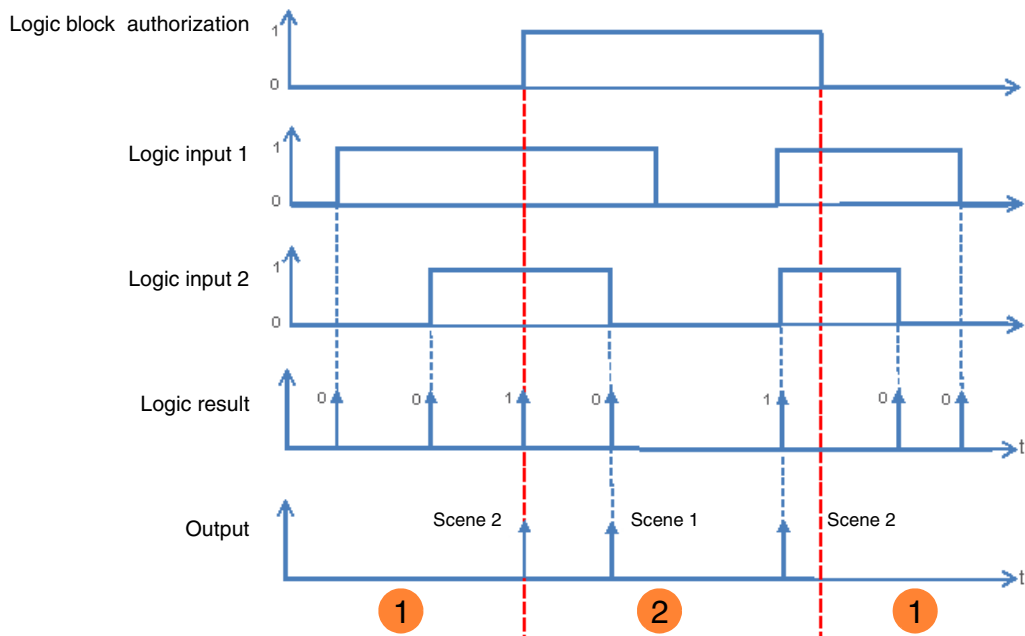

- ① The logic result has no influence on the outputCurrent values.
- ② The commands from the logic result are executed.

Note: The commands from the logic result are executed immediately after authorization, according to the **Logic result after authorization** parameter.

Parameter	Description	Value
Authorization object logic block	The Logic block 1 – Authorization communication object and related parameters are hidden.	Not active*
	The Logic block 1 – Authorization communication object and related parameters are displayed.	Active

Note: If the logic block is locked the logic operation is not processed.

Communication objects:

- Block 1 [42 - Logic block 1 - Authorization \(1 bit - 1.003 DPT_Enable\)](#)
- Block 2 [48 - Logic block 2 - Authorization \(1 bit - 1.003 DPT_Enable\)](#)

* Default value

Parameter	Description	Value
Value at initialization	On initialization of the device after a download or after return of the bus power, the value of the Logic block 1 – Authorization object is: Set to 0. Set to 1. Set according to the value that the object had before initialization.	0 1 Value before initialization*

Note: This parameter is only visible if the **Authorization object logic block** parameter has the following value: **Active**.

Parameter	Description	Value
Polarity	On receipt of a value on the Logic block 1 – Authorization object, this is: Locked-up on object value 1. Locked-up on object value 0.	0 = Authorized, 1 = Locked-up 0 = Locked-up, 1 = Authorized*

Note: This parameter is only visible if the **Authorization object logic block** parameter has the following value: **Active**.

Parameter	Description	Value
Logic result after autorisation	On authorization of the logic block: The value of the Logic result is immediately determined. The value of the logic result is first determined after receipt of a value on a logic input.	Immediate emission when authorization* No immediate emission

Note: This parameter is only visible if the **Authorization object logic block** parameter has the following value: **Active**.

3.6.1.3 Logic result

Parameter	Description	Value
Emission of logic result	The Logic result object will be sent on: Each receipt of a telegram on one of the logic inputs. A change in the value of the logic result.	By input value change By logic result value change*

Parameter	Description	Value
Logic result acts on outputs	The logic results acts: Only on the Logic result communication object. On the Logic result communication object and directly on one or more outputs.	Not active* Active

The status of the affected outputs is determined by the parameter **action on logic result = x**.

* Default value

Parameter	Description	Value
Output 1 ... x	The output relationship with the Logic result is: Directly dependent. Independent.	Yes* No

*Note: This parameter is only visible if the **Logic result acts on outputs** parameter has the following value: **Active**.*

Parameter	Description	Value
Action if logic result = 0	On the outputs that are directly dependent on Logic result, if the output value = 0, the status: Not changed. Is switched to the opposite status. Selectively switched on. Selectively switched off. Starts timer mode. Stops timer mode. Starts one of the 64 scenes. Adopts the default value given by the parameter Status if preset 1 object = 0 . Adopts the default value given by the parameter Status if preset 2 object = 0 .	Maintain status Inversion ON OFF* Timer start Timer stop Scene number Preset 1 Preset 2

Note: The Timer mode, Scene function or Preset function of the selected output must be configured. If this is not the case, the status remains unchanged.

Parameter	Description	Value
Scene if logic result = 0	This parameter determines the scene number that is activated if the logic result is 0 after re-evaluation.	Scene 1 ... 64 Default value: 1

The outputs respond according to the scene numbers and associated parameters.

*Note: This parameter is only visible if the **Action if logic result = 0** parameter has the following value: **Scene number**.*

* Default value

Parameter	Description	Value
Action if logic result = 1	<p>On the outputs that are directly dependent on Logic result, if the output value = 1, the status:</p> <p>Not changed.</p> <p>Is switched to the opposite status.</p> <p>Selectively switched on.</p> <p>Selectively switched off.</p> <p>Starts timer mode.</p> <p>Stops timer mode.</p> <p>Starts one of the 64 scenes.</p> <p>Adopts the default value given by the parameter Status if preset 1 object = 1.</p> <p>Adopts the default value given by the parameter Status if preset 2 object = 1.</p>	<p>Maintain status</p> <p>Inversion</p> <p>ON*</p> <p>OFF</p> <p>Timer start</p> <p>Timer stop</p> <p>Scene number</p> <p>Preset 1</p> <p>Preset 2</p>

Note: The Timer mode, Scene function or Preset function of the selected output must be configured. If this is not the case, the status remains unchanged.

Parameter	Description	Value
Scene if logic result = 1	This parameter determines the scene number that is activated if the logic result is 1 after re-evaluation.	<p>Scene 1 ... 64</p> <p>Default value: 2</p>

The outputs respond according to the scene numbers and associated parameters.

*Note: This parameter is only visible if the **Action if logic result = 1** parameter has the following value: **Scene number**.*

* Default value

3.6.2 Logic block : Shutter

The behaviour is determined by the following parameters:

Note: The description of the parameters is given for logic block 1. The parameters and objects are identical for logic block 2 ; Only the terms will be adjusted.

Device: 1.1.2 10-fold switch actuator 4A 230V AC

<ul style="list-style-type: none"> Outputs 1-10: Function Outputs 1-10: Function selection <ul style="list-style-type: none"> - O1-10: Manual mode ON/OFF - O1-10: Status indications ON/OFF <li style="background-color: #e0e0e0;">- O1-10: Logic block 1 shutter - O1-10: Logic block 2 shutter Outputs 1-2: Function selection Output 3: Function selection Output 4: Function selection Output 5: Function selection Output 6: Function selection Output 7: Function selection Output 8: Function selection Output 9: Function selection Output 10: Function selection Information 	<p>Logic function type: OR</p> <p>Number of logic input: 1</p> <p>Inverting value of logic input 1: Maintain status</p> <p>Value at initialization logic input 1: Value before initialization</p> <p>Authorization object logic block: Active</p> <p>Value at initialization: Value before initialization</p> <p>Polarity: 0 = Locked-up , 1 = Authorized</p> <p>Logic result after autorisation: Immediate emission when authorization</p> <p>Emission of logic result: By logic result value change</p> <p>Logic result acts on outputs: Active</p> <p>Output 1: Yes</p> <p>Output 2: Yes</p> <p>Output 3: Yes</p> <p>Output 4: Yes</p> <p>Output 5: Yes</p> <p>Action if logic result = 0: Maintain status</p> <p>Action if logic result = 1: Maintain status</p>
---	--

3.6.2.1 Configuration of the Logic function

Parameter	Description	Value
Logic function type	The input objects are: OR linked. AND linked.	Or* And

For logic table see: [Appendix](#).

* Default value

Parameter	Description	Value
Number of logic inputs	This parameter determines the number of inputs of the logic block. Up to 4 inputs can be used.	1* 2 3 4

Communication objects:

Block 1 [220 - Logic block 1 - Input 2 \(1 bit - 1.002 DPT_Bool\)](#)
 [221 - Logic block 1 - Input 3 \(1 bit - 1.002 DPT_Bool\)](#)
 [222 - Logic block 1 - Input 4 \(1 bit - 1.002 DPT_Bool\)](#)

Block 2 [226 - Logic block 2 - Input 2 \(1 bit - 1.002 DPT_Bool\)](#)
 [227 - Logic block 2 - Input 3 \(1 bit - 1.002 DPT_Bool\)](#)
 [228 - Logic block 2 - Input 4 \(1 bit - 1.002 DPT_Bool\)](#)

Parameter	Description	Value
Inverting value of logic input x	The value of logic input x works on the logic block: With its object value (0=0, 1=1). With inverted object value (0=1, 1=0).	Maintain status* Status inversion

x = 1 to 4

Parameter	Description	Value
Value at initialization of logic input x	On initialization of the device after a download or after return of the bus power, the value of the logic input is: Set to 0. Set to 1. Set according to the value of the logic input before the initialization occurred.	0 1 Value before initialization*

x = 1 to 4

* Default value

3.6.2.2 Logic block authorization

Principle of logic block authorization:

The parameters are set as follows:

- Logic block authorization: 0 = Locked-up, 1 = Authorized.
- Action if logic result = 0 : Scene 1.
- Action if logic result = 1 : Scene 2.
- Logic input 1 and 2 are AND-linked.
- Emission of logic result: By input value change.

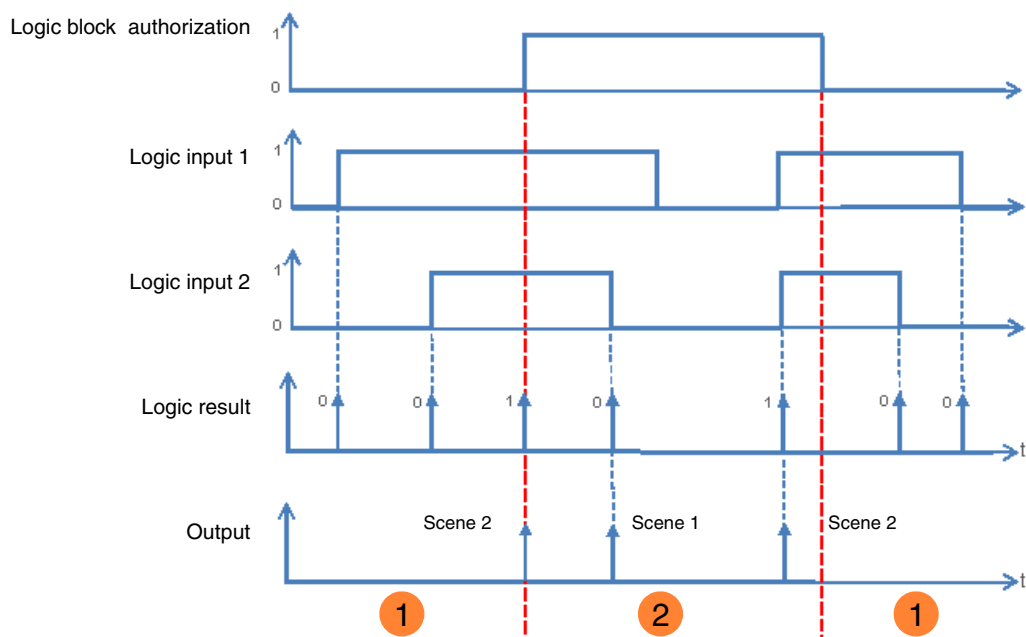

- ① The logic result has no influence on the outputCurrent values.
- ② The commands from the logic result are executed.

Note: The commands from the logic result are executed immediately after authorization, according to the **Logic result after authorization** parameter.

Parameter	Description	Value
Authorization object logic block	The Logic block 1 – Authorization communication object and related parameters are hidden.	Not active*
	The Logic block 1 – Authorization communication object and related parameters are displayed.	Active

Note: If the logic block is locked the logic operation is not processed.

Communication objects:

- Block 1 **218 - Logic block 1 - Authorization** (1 bit - 1.003 DPT_Enable)
- Block 2 **224 - Logic block 2 - Authorization** (1 bit - 1.003 DPT_Enable)

* Default value

Parameter	Description	Value
Value at initialization	On initialization of the device after a download or after return of the bus power, the value of the Logic block 1 – Authorization object is: Set to 0. Set to 1. Set according to the value that the object had before initialization.	0 1 Value before initialization*

*Note: This parameter is only visible if the **Authorization object logic block** parameter has the following value: **Active**.*

Parameter	Description	Value
Polarity	On receipt of a value on the Logic block 1 – Authorization object, this is: Locked-up on object value 1. Locked-up on object value 0.	0 = Authorized, 1 = Locked-up 0 = Locked-up, 1 = Authorized*

*Note: This parameter is only visible if the **Authorization object logic block** parameter has the following value: **Active**.*

Parameter	Description	Value
Logic result after autorisation	On authorization of the logic block: The value of the Logic result is immediately determined. The value of the logic result is first determined after receipt of a value on a logic input.	Immediate emission when authorization* No immediate emission

*Note: This parameter is only visible if the **Authorization object logic block** parameter has the following value: **Active**.*

* Default value

3.6.2.3 Logic result

Parameter	Description	Value
Emission of logic result	The Logic result object will be sent on: Each receipt of a telegram on one of the logic inputs. A change in the value of the logic result.	By input value change By logic result value change*

Parameter	Description	Value
Logic result acts on outputs	The logic results acts: Only on the Logic result communication object. On the Logic result communication object and directly on one or more outputs.	Not active* Active

The status of the affected outputs is determined by the parameter **action on logic result = x**.

Parameter	Description	Value
Output 1 ... x	The output relationship with the Logic result is: Directly dependent. Independent.	Yes* No

*Note: This parameter is only visible if the **Logic result acts on outputs** parameter has the following value: **Active**.*

Parameter	Description	Value
Action if logic result = 0	Outputs that are directly dependent on Logic 1 result will, on output value 0: Not changed. Closes the Up contact. Closes the down contact. Opens the 2 contacts. Runs to a specific position. Runs to a position set in a scene. Run to the default position set in the Status if preset 1 object = 0 parameter Run to the default position set in the Status if preset 2 object = 0 parameter	Maintain status* Up Down Stop Specific position Scene number Preset 1 Preset 2

Note: The Scene function or Preset function of the selected output must be configured. If this is not the case, the status remains unchanged.

Parameter	Description	Value
Position (0-100%)	This parameter determines the position of the shutter or blind to be activated if the logic result is 0 after re-evaluation.	0 ... 5* ... 100

*Note: This parameter is only visible if the **Action if logic result = 0** parameter has the following value: **Specific position**.*

* Default value

Parameter	Description	Value
Slat angle (0-100%)	This parameter determines the slat position of the blind to be set if the logic result is 0 after re-evaluation.	0 ... 5* ... 100

Note: This parameter is only visible if the **Action if logic result = 0** parameter has the following value: **Specific position**.

Parameter	Description	Value
Scene if logic result = 0	This parameter determines the scene number that is activated if the logic result is 0 after re-evaluation.	Scene 1 ... 64 Default value: 1

The outputs respond according to the scene numbers and associated parameters.

Note: This parameter is only visible if the **Action if logic result = 0** parameter has the following value: **Scene number**.

Parameter	Description	Value
Action if logic result = 1	Outputs that are directly dependent on Logic 1 result will, on output value 1: Not changed. Closes the Up contact. Closes the down contact. Opens the 2 contacts. Runs to a specific position. Runs to a position set in a scene. Run to the default position set in the Status if preset 1 object = 0 parameter Run to the default position set in the Status if preset 2 object = 0 parameter	Maintain status* Up Down Stop Specific position Scene number Preset 1 Preset 2

Note: The Scene function or Preset function of the selected output must be configured. If this is not the case, the status remains unchanged.

Parameter	Description	Value
Position (0-100%)	This parameter determines the position of the shutter or blind to be activated if the logic result is 1 after re-evaluation.	0 ... 5* ... 100

Note: This parameter is only visible if the **Action if logic result = 1** parameter has the following value: **Specific position**.

Parameter	Description	Value
Slat angle (0-100%)	This parameter determines the slat position of the blind to be set if the logic result is 1 after re-evaluation.	0 ... 5* ... 100

Note: This parameter is only visible if the **Action if logic result = 1** parameter has the following value: **Specific position**.

* Default value

Parameter	Description	Value
Scene if logic result = 1	This parameter determines the scene number that is activated if the logic result is 1 after re-evaluation.	Scene 1 ... 64 Default value: 1

The outputs respond according to the scene numbers and associated parameters.

*Note: This parameter is only visible if the **Action if logic result = 1** parameter has the following value: **Scene number**.*

3.7 Diagnosis

The **Device diagnosis** object allows notifications about the operating status of the device to be sent via the KNX bus. This information is sent periodically and/or on status change.

The **Device diagnosis** object allows reporting of current faults according to the device and application. It also allows sending of the position of the switch on the front of the device and the number of the output that is affected by the fault(s).

The **Device Diagnosis** object is a 6-byte object that is composed as described below:

Byte number	6 (MSB)	5	4	3	2	1 (LSB)
Use	Switch position	Application type	Output number	Error codes		

Details of the byte:

- **Bytes 1 to 4:** Correspond to the error codes.

MSB

LSB

b31	b30	b29	b28	b27	b26	b25	b24	b23	b22	b21	b20	b19	b18	b17	b16	b15	b14	b13	b12	b11	b10	b9	b8	b7	b6	b5	b4	b3	b2	b1	b0
32	X	X	X	28	27	X	X	X	X	X	X	X	X	X	X	X	X	X	X	X	X	X	9	X	X	X	X	X	X	X	X

N°	Faults
27	Wrong context: The user's parameters are not transferable. The standard parameters are restored.
28	TP communication out of operation: Communication via the KNX bus was not available on the previous start.
32	Minimum switching time not complied with: The device is equipped with a mechanism for limiting the number of switching cycles per minute of the output contact. If the user requires a number of switching cycles that is greater than this limit, this bit informs the user that his command was not carried out.
9	Excessive number of restarts: This bit is use for notification of repeated restarts and/or a restart triggered by a Watch-Dog. Such a restart is not necessarily apparent to the user from the function, rather it is manifest as a disturbed environment or a bad contact of the power supply.

Note: The use of the standard bit depends on the type of device used (switch actuator, dimmer, shutter/blind, etc.). Certain bit are same for all devices and others are application-specific.

- **Byte 5:** Corresponds to the application type and the number of the output affected by the error.

MSB

LSB

b7	b6	b5	b4	b3	b2	b1	b0
Application type				Output number			
0 = Not defined				0 = Device error			
1 = Switch actuator				1 = Output 1			
2 = Shutter/blind				2 = Output 2			
3 = Dimmer						
				Y = Output Y			

Note: Y is the placeholder for the maximum number of outputs.

- **Byte 6:** Switch position.

MSB							LSB
b7	b6	b5	b4	b3	b2	b1	b0
X	X	X	X	X	X	X	1

1: 0 = Automatic mode / 1 = Manual mode

Note: Bit marked with an x are not used.

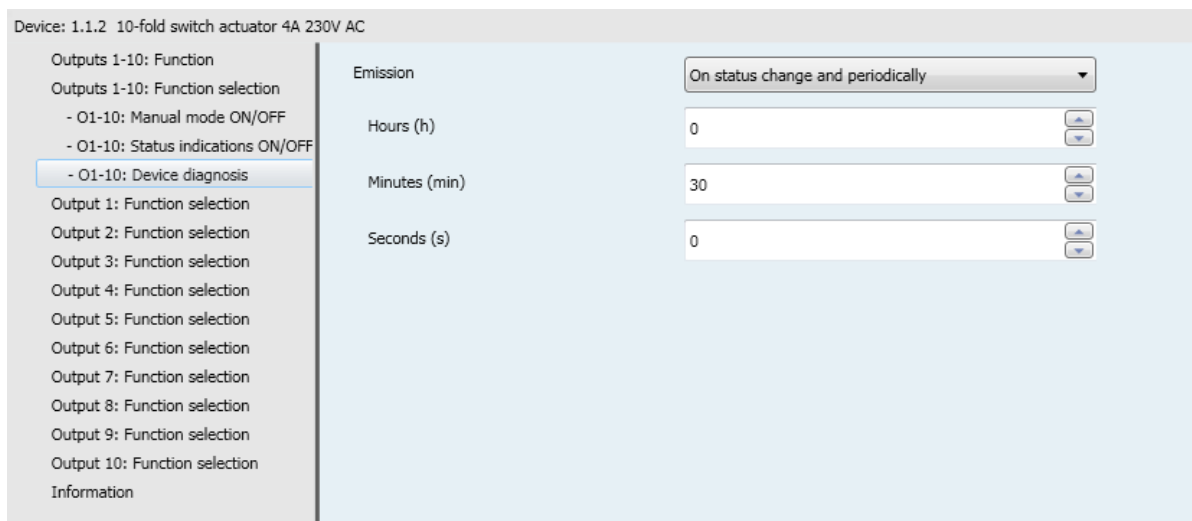

Parameter	Description	Value
Emission	The Device diagnosis communication object is sent to bus: On each change. Periodically after a configurable time. On change and periodically after a configurable time.	On status change* Periodically On status change and periodically

Parameter	Description	Value
Hours (h)	This parameter determines the time between the individual transmissions of the Device diagnosis object.	0 hours: 0 to 23 h
Minutes (min)		30 minutes: 0 to 59 min
Seconds (s)		0 seconds: 0 to 59 s

Note: The smallest executable time is 1 second.

*Note: This parameter is only visible if the **Emission** parameter has the following value: **Periodically** or **On status change and periodically**.*

* Default value

3.8 Functions of each switch actuator

This parameter window is used to set the device outputs. These parameters are available individually for each output.

3.8.1 Function selection

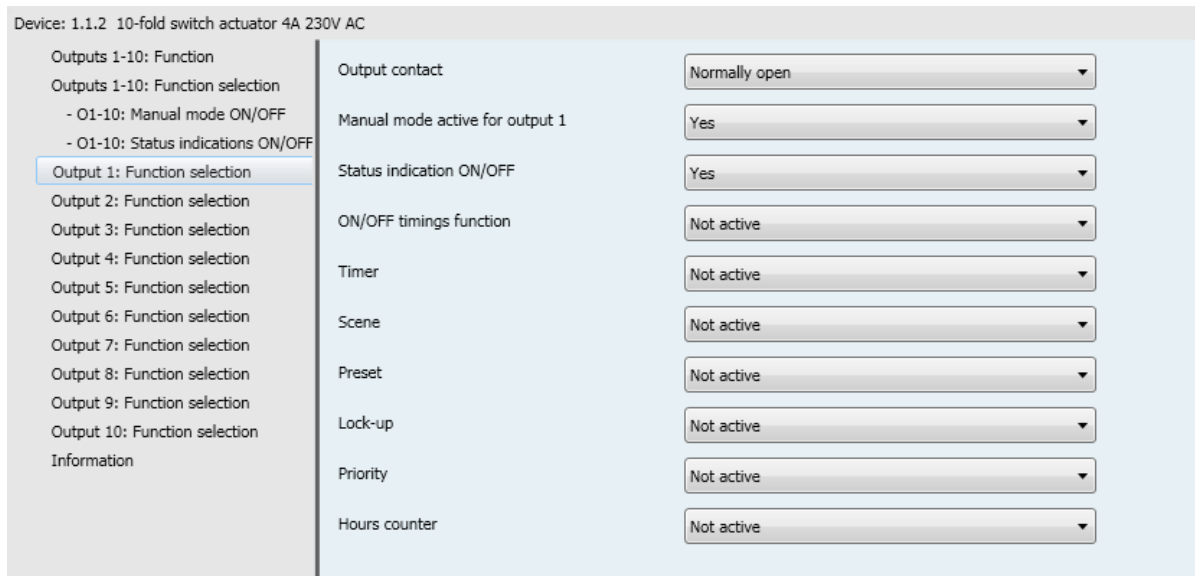

Parameter	Description	Value
Output contact	On receipt of an ON command: The output relay closes. The output relay opens.	Normally open* Normally closed

Principle:

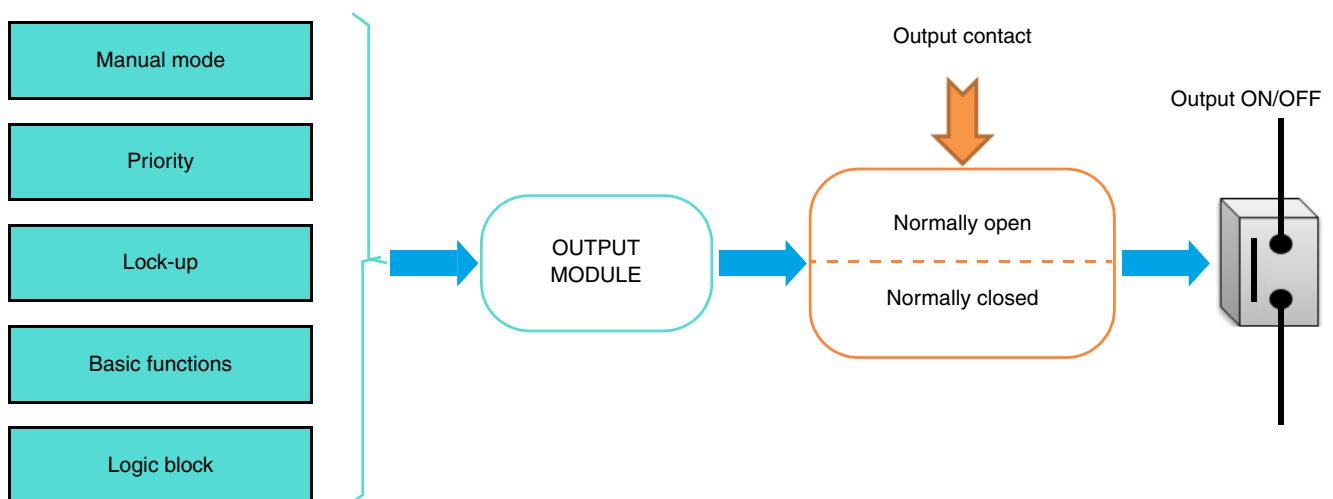

* Default value

Parameter	Description	Value
Manual mode active for output 1	This output can be controlled in manual mode.	Yes*
	This output is excluded from manual mode.	No

Parameter	Description	Value
Status indication ON/OFF	The Status indication ON/OFF communication object is: Hidden.	No
	Displayed, the status indication can be transmitted over the bus.	Yes*

Communication objects:

- [3 - Output 1 - Status indication ON/OFF](#) (1 bit - 1.001 DPT_Switch)
- [23 - Output 2 - Status indication ON/OFF](#) (1 bit - 1.001 DPT_Switch)
- [43 - Output 3 - Status indication ON/OFF](#) (1 bit - 1.001 DPT_Switch)
- [63 - Output 4 - Status indication ON/OFF](#) (1 bit - 1.001 DPT_Switch)
- [83 - Output 5 - Status indication ON/OFF](#) (1 bit - 1.001 DPT_Switch)
- [103 - Output 6 - Status indication ON/OFF](#) (1 bit - 1.001 DPT_Switch)
- [123 - Output 7 - Status indication ON/OFF](#) (1 bit - 1.001 DPT_Switch)
- [143 - Output 8 - Status indication ON/OFF](#) (1 bit - 1.001 DPT_Switch)
- [163 - Output 9 - Status indication ON/OFF](#) (1 bit - 1.001 DPT_Switch)
- [183 - Output 10 - Status indication ON/OFF](#) (1 bit - 1.001 DPT_Switch)

*Note: The transmission conditions for the Status indication objects must be set in the parameter Register **O1-Ox: Status indication**.*

Parameter	Description	Value
ON/OFF timings function	The ON/OFF timings function tab and the associated parameters and objects are:	Not active* Active
	Hidden. Displayed.	

For configuration see section: [ON/OFF timings function](#).

Parameter	Description	Value
Timer	The Timer tab and the associated parameters and objects are:	Not active* Active
	Hidden. Displayed.	

* Default value

Communication objects:

- 4 - **Output 1 - Timer** (1 bit - 1.001 DPT_Switch)
- 24 - **Output 2 - Timer** (1 bit - 1.001 DPT_Switch)
- 44 - **Output 3 - Timer** (1 bit - 1.001 DPT_Switch)
- 64 - **Output 4 - Timer** (1 bit - 1.001 DPT_Switch)
- 84 - **Output 5 - Timer** (1 bit - 1.001 DPT_Switch)
- 104 - **Output 6 - Timer** (1 bit - 1.001 DPT_Switch)
- 124 - **Output 7 - Timer** (1 bit - 1.001 DPT_Switch)
- 144 - **Output 8 - Timer** (1 bit - 1.001 DPT_Switch)
- 164 - **Output 9 - Timer** (1 bit - 1.001 DPT_Switch)
- 184 - **Output 10 - Timer** (1 bit - 1.001 DPT_Switch)

For configuration see section: [Timer](#).

Parameter	Description	Value
Scene	The Scenes tab and the associated parameters and objects are: Hidden. Displayed.	Not active* Active

Communication objects:

- 6 - **Output 1 - Scene** (1 byte - 17.001 DPT_SceneNumber)
- 26 - **Output 2 - Scene** (1 byte - 17.001 DPT_SceneNumber)
- 46 - **Output 3 - Scene** (1 byte - 17.001 DPT_SceneNumber)
- 66 - **Output 4 - Scene** (1 byte - 17.001 DPT_SceneNumber)
- 86 - **Output 5 - Scene** (1 byte - 17.001 DPT_SceneNumber)
- 106 - **Output 6 - Scene** (1 byte - 17.001 DPT_SceneNumber)
- 126 - **Output 7 - Scene** (1 byte - 17.001 DPT_SceneNumber)
- 146 - **Output 8 - Scene** (1 byte - 17.001 DPT_SceneNumber)
- 166 - **Output 9 - Scene** (1 byte - 17.001 DPT_SceneNumber)
- 186 - **Output 10 - Scene** (1 byte - 17.001 DPT_SceneNumber)

For configuration see section: [Scene ON/OFF](#).

Parameter	Description	Value
Preset	The Preset tab and the associated parameters and objects are: Hidden. Displayed for 1 Preset object. Displayed for 2 Preset objects.	Not active* Active with preset 1-level object Active with preset 2-level objects

Note: When the value of this parameter changes, the associated parameters and group addresses are deleted.

* Default value

Preset 1 communication
Objets

- 7 - Output 1 - Preset 1 (1 bit - 1.022 DPT_Scene_AB)
- 27 - Output 2 - Preset 1 (1 bit - 1.022 DPT_Scene_AB)
- 47 - Output 3 - Preset 1 (1 bit - 1.022 DPT_Scene_AB)
- 67 - Output 4 - Preset 1 (1 bit - 1.022 DPT_Scene_AB)
- 87 - Output 5 - Preset 1 (1 bit - 1.022 DPT_Scene_AB)
- 107 - Output 6 - Preset 1 (1 bit - 1.022 DPT_Scene_AB)
- 127 - Output 7 - Preset 1 (1 bit - 1.022 DPT_Scene_AB)
- 147 - Output 8 - Preset 1 (1 bit - 1.022 DPT_Scene_AB)
- 167 - Output 9 - Preset 1 (1 bit - 1.022 DPT_Scene_AB)
- 187 - Output 10 - Preset 1 (1 bit - 1.022 DPT_Scene_AB)

Preset 2 communication
Objets

- 8 - Output 1 - Preset 2 (1 bit - 1.022 DPT_Scene_AB)
- 28 - Output 2 - Preset 2 (1 bit - 1.022 DPT_Scene_AB)
- 48 - Output 3 - Preset 2 (1 bit - 1.022 DPT_Scene_AB)
- 68 - Output 4 - Preset 2 (1 bit - 1.022 DPT_Scene_AB)
- 88 - Output 5 - Preset 2 (1 bit - 1.022 DPT_Scene_AB)
- 108 - Output 6 - Preset 2 (1 bit - 1.022 DPT_Scene_AB)
- 128 - Output 7 - Preset 2 (1 bit - 1.022 DPT_Scene_AB)
- 148 - Output 8 - Preset 2 (1 bit - 1.022 DPT_Scene_AB)
- 168 - Output 9 - Preset 2 (1 bit - 1.022 DPT_Scene_AB)
- 188 - Output 10 - Preset 2 (1 bit - 1.022 DPT_Scene_AB)

For configuration see section: [Preset ON/OFF](#).

Parameter	Description	Value
Lock-up	The Lock-up tab and the associated parameters and objects are: Hidden. Displayed for 1 lock-up object. Displayed for 2 lock-up objects.	Not active* 1 lock-up object 2 lock-up objects

Lock-up 1 communication
objects

- 11 - Output 1 - Lock-up 1 (1 bit - 1.003 DPT_Enable)
- 31 - Output 2 - Lock-up 1 (1 bit - 1.003 DPT_Enable)
- 51 - Output 3 - Lock-up 1 (1 bit - 1.003 DPT_Enable)
- 71 - Output 4 - Lock-up 1 (1 bit - 1.003 DPT_Enable)
- 91 - Output 5 - Lock-up 1 (1 bit - 1.003 DPT_Enable)
- 111 - Output 6 - Lock-up 1 (1 bit - 1.003 DPT_Enable)
- 131 - Output 7 - Lock-up 1 (1 bit - 1.003 DPT_Enable)
- 151 - Output 8 - Lock-up 1 (1 bit - 1.003 DPT_Enable)
- 171 - Output 9 - Lock-up 1 (1 bit - 1.003 DPT_Enable)
- 191 - Output 10 - Lock-up 1 (1 bit - 1.003 DPT_Enable)

* Default value

Lock-up 2 communication objects

- 12 - Output 1 - Lock-up 2 (1 bit - 1.003 DPT_Enable)
- 32 - Output 2 - Lock-up 2 (1 bit - 1.003 DPT_Enable)
- 52 - Output 3 - Lock-up 2 (1 bit - 1.003 DPT_Enable)
- 72 - Output 4 - Lock-up 2 (1 bit - 1.003 DPT_Enable)
- 92 - Output 5 - Lock-up 2 (1 bit - 1.003 DPT_Enable)
- 112 - Output 6 - Lock-up 2 (1 bit - 1.003 DPT_Enable)
- 132 - Output 7 - Lock-up 2 (1 bit - 1.003 DPT_Enable)
- 152 - Output 8 - Lock-up 2 (1 bit - 1.003 DPT_Enable)
- 172 - Output 9 - Lock-up 2 (1 bit - 1.003 DPT_Enable)
- 192 - Output 10 - Lock-up 2 (1 bit - 1.003 DPT_Enable)

For configuration see section: [Lock-up ON/OFF](#).

Parameter	Description	Value
Priority	The Priority tab and the associated parameters and objects are: Hidden. Displayed.	Not active* Active

The device responds to telegrams received via the **Priority** object, as given in the following table:

Telegram received by the priority operation object		Status of the outputs
Bit 1	Bit 2	
0	0	End of the priority
0	1	End of the priority
1	0	Priority OFF
1	1	Priority ON

Communication objects:

- 14 - Output 1 - Priority (2 bit - 2.002 DPT_Bool_Control)
- 34 - Output 2 - Priority (2 bit - 2.002 DPT_Bool_Control)
- 54 - Output 3 - Priority (2 bit - 2.002 DPT_Bool_Control)
- 74 - Output 4 - Priority (2 bit - 2.002 DPT_Bool_Control)
- 94 - Output 5 - Priority (2 bit - 2.002 DPT_Bool_Control)
- 114 - Output 6 - Priority (2 bit - 2.002 DPT_Bool_Control)
- 134 - Output 7 - Priority (2 bit - 2.002 DPT_Bool_Control)
- 154 - Output 8 - Priority (2 bit - 2.002 DPT_Bool_Control)
- 174 - Output 9 - Priority (2 bit - 2.002 DPT_Bool_Control)
- 194 - Output 10 - Priority (2 bit - 2.002 DPT_Bool_Control)

For configuration see section: [Priority ON/OFF](#).

* Default value

Parameter	Description	Value
Hours counter	The Hours counter tab and the associated parameters and objects are: Hidden. Displayed.	Not active* Active

A telegram can be transmitted via the **Hours counter setpoint reached** object, in accordance with a programmable setpoint. It is also possible to reset the count value via a 1 signal on the **Reset hours counter value** object.

Communication objects:

16 - Output 1 - Hours counter value (2 byte - 7.001 DPT_16_bit_Counter)

36 - Output 2 - Hours counter value (2 byte - 7.001 DPT_16_bit_Counter)

56 - Output 3 - Hours counter value (2 byte - 7.001 DPT_16_bit_Counter)

76 - Output 4 - Hours counter value (2 byte - 7.001 DPT_16_bit_Counter)

96 - Output 5 - Hours counter value (2 byte - 7.001 DPT_16_bit_Counter)

116 - Output 6 - Hours counter value (2 byte - 7.001 DPT_16_bit_Counter)

136 - Output 7 - Hours counter value (2 byte - 7.001 DPT_16_bit_Counter)

156 - Output 8 - Hours counter value (2 byte - 7.001 DPT_16_bit_Counter)

176 - Output 9 - Hours counter value (2 byte - 7.001 DPT_16_bit_Counter)

196 - Output 10 - Hours counter value (2 byte - 7.001 DPT_16_bit_Counter)

17 - Output 1 - Reset hours counter value (1 bit - 1.015 DPT_Reset)

37 - Output 2 - Reset hours counter value (1 bit - 1.015 DPT_Reset)

57 - Output 3 - Reset hours counter value (1 bit - 1.015 DPT_Reset)

77 - Output 4 - Reset hours counter value (1 bit - 1.015 DPT_Reset)

97 - Output 5 - Reset hours counter value (1 bit - 1.015 DPT_Reset)

117 - Output 6 - Reset hours counter value (1 bit - 1.015 DPT_Reset)

137 - Output 7 - Reset hours counter value (1 bit - 1.015 DPT_Reset)

157 - Output 8 - Reset hours counter value (1 bit - 1.015 DPT_Reset)

177 - Output 9 - Reset hours counter value (1 bit - 1.015 DPT_Reset)

197 - Output 10 - Reset hours counter value (1 bit - 1.015 DPT_Reset)

18 - Output 1 - Hours counter setpoint reached (1 bit - 1.002 DPT_Bool)

38 - Output 2 - Hours counter setpoint reached (1 bit - 1.002 DPT_Bool)

58 - Output 3 - Hours counter setpoint reached (1 bit - 1.002 DPT_Bool)

78 - Output 4 - Hours counter setpoint reached (1 bit - 1.002 DPT_Bool)

98 - Output 5 - Hours counter setpoint reached (1 bit - 1.002 DPT_Bool)

118 - Output 6 - Hours counter setpoint reached (1 bit - 1.002 DPT_Bool)

138 - Output 7 - Hours counter setpoint reached (1 bit - 1.002 DPT_Bool)

158 - Output 8 - Hours counter setpoint reached (1 bit - 1.002 DPT_Bool)

178 - Output 9 - Hours counter setpoint reached (1 bit - 1.002 DPT_Bool)

198 - Output 10 - Hours counter setpoint reached (1 bit - 1.002 DPT_Bool)

For configuration see section: [Hours counter](#).

* Default value

3.8.2 ON/OFF timings function

Device: 1.1.2 10-fold switch actuator 4A 230V AC

Outputs 1-10: Function selection

Outputs 1-10: Function selection

- O1-10: Manual mode ON/OFF
- O1-10: Status indications ON/OFF

Output 1: Function selection

- O1: ON/OFF object timings

Output 2: Function selection

Output 3: Function selection

Output 4: Function selection

Output 5: Function selection

Output 6: Function selection

Output 7: Function selection

Output 8: Function selection

Output 9: Function selection

Output 10: Function selection

Information

Delays for ON/OFF objects

Switching and tripping delay ▼

Switching delay (h)

Switching delay (min)

Switching delay (s), minimum value 1s

Tripping delay (h)

Tripping delay (min)

Tripping delay (s), minimum value 1s

Timer/toggle switch changeover for object ON/OFF

Active ▼

Hours (h)

Minutes (min)

Seconds (s), minimum value 1s

Additional time limited toggle switch function

Active ▼

Hours (h)

Minutes (min)

Seconds (s), minimum value 1s

3.8.2.1 Delays for ON/OFF objects

Parameter	Description	Value
Delays for ON/OFF objects	The parameters for time-delayed switching of the outputs are: Hidden. Displayed for Switching delay. Displayed for Tripping delay. Displayed for Switching and tripping delay.	Not active* Switching delay Tripping delay Switching and tripping delay

* Default value

Switching delay: Allows the configuration of a delay between the switch-on command and the switching of the output contact.

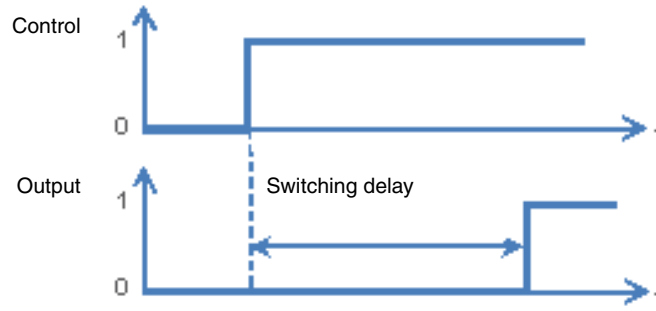

Tripping delay: Allows the configuration of a delay between the switch-off command and the switching of the output contact.

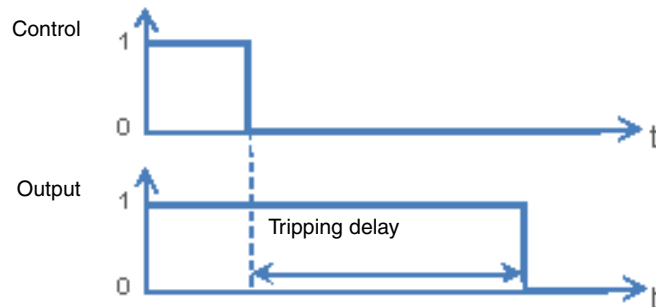

Switching and tripping delay: Allows the configuration of a delay between the switch-on command and the switching of the output contact, as well as between the switch-off command and the switching of the output contact.

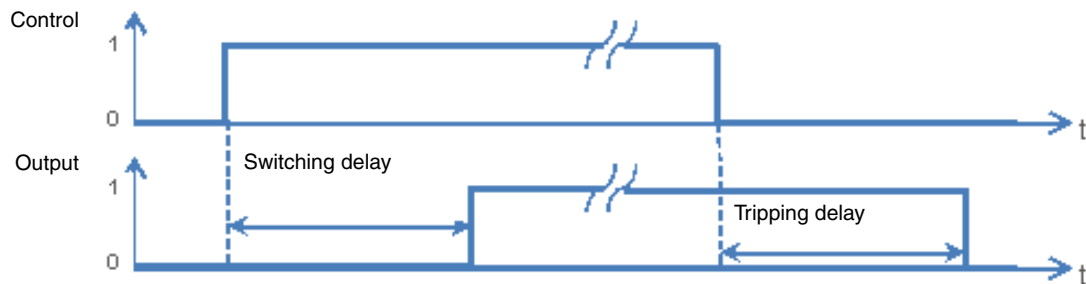

Parameter	Description	Value
Switching delay	This parameter defines the delay between the switch-on command and the switching of the output contact.	0 hours: 0 to 23 h 3 minutes: 0 to 59 min 0 seconds: 0 to 59 s

Note: The smallest executable time is 1 second.

*Note: This parameter is only visible if the **Delays for ON/OFF** objects parameter has the following value: **Switching delay** or **Switching and tripping delay**.*

Parameter	Description	Value
Tripping delay	This parameter defines the delay between the switch-off command and the switching of the output contact.	0 hours: 0 to 23 h 3 minutes: 0 to 59 min 0 seconds: 0 to 59 s

Note: The smallest executable time is 1 second.

*Note: This parameter is only visible if the **Delays for ON/OFF** objects parameter has the following value: **Tripping delay** or **Switching and tripping delay**.*

3.8.2.2 Timer/toggle switch changeover for ON/OFF object

This function switches the output channels between toggle switch and timer mode for the **ON/OFF** object.

Example: Switching function daytime and Time-limited OFF function at night.

During the day, the button is used as a switch. In the evenings, the button is used as a time-limited OFF switch, so that the light will turn off automatically.

Parameter	Description	Value
Timer/toggle switch changeover for ON/OFF object	The parameters for a switch-over between toggle switch and timer modes for the ON/OFF object are: Hidden. Displayed.	Not active* Active

- If the **Timer/toggle switch changeover** object receives the value 1, the Toggle-switch mode function is activated. The ON/OFF switching of the output is performed as usual via the **ON/OFF** object.
- If the **Timer/toggle switch changeover** object receives the value 0, the Timer mode function is activated.
 - If the **ON/OFF** object receives the value 1, the output is switched ON. After expiry of a configurable time, the output is automatically switched OFF.
 - If the **ON/OFF** object receives the value 0, the output is switched OFF.

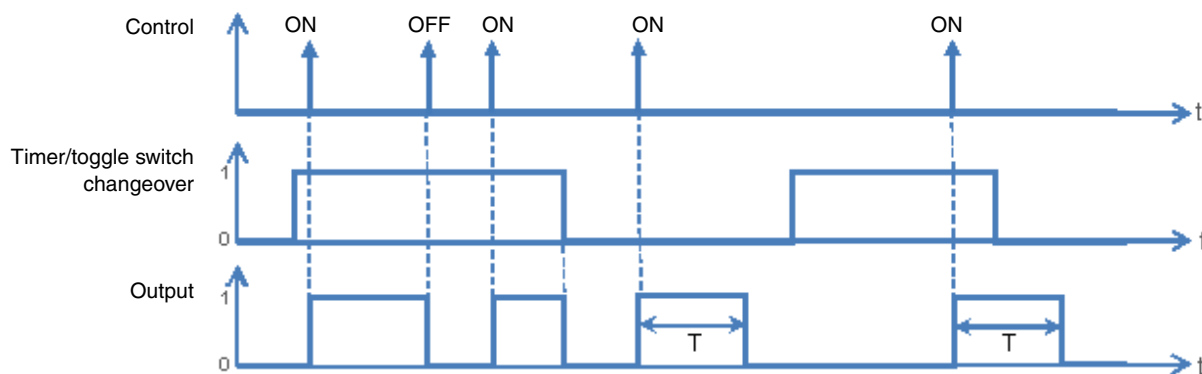

Communication objects:

- 1 - Output 1 - Timer/toggle switch changeover (1 bit - 1.001 DPT_Switch)
- 21 - Output 2 - Timer/toggle switch changeover (1 bit - 1.001 DPT_Switch)
- 41 - Output 3 - Timer/toggle switch changeover (1 bit - 1.001 DPT_Switch)
- 61 - Output 4 - Timer/toggle switch changeover (1 bit - 1.001 DPT_Switch)
- 81 - Output 5 - Timer/toggle switch changeover (1 bit - 1.001 DPT_Switch)
- 101 - Output 6 - Timer/toggle switch changeover (1 bit - 1.001 DPT_Switch)
- 121 - Output 7 - Timer/toggle switch changeover (1 bit - 1.001 DPT_Switch)
- 141 - Output 8 - Timer/toggle switch changeover (1 bit - 1.001 DPT_Switch)
- 161 - Output 9 - Timer/toggle switch changeover (1 bit - 1.001 DPT_Switch)
- 181 - Output 10 - Timer/toggle switch changeover (1 bit - 1.001 DPT_Switch)

* Default value

Parameter	Description	Value
Hours (h)	This parameter sets the length of the timer operation, if this is activated.	1 hours: 0 to 23 h
Minutes (min)		0 minutes: 0 to 59 min
Seconds (s)		0 seconds: 0 to 59 s

Note: The smallest executable time is 1 second.

Note: This parameter is only visible if the **Timer/toggle switch changeover parameter for the ON/OFF object** has the following value: **Active**.

3.8.2.3 Time limited toggle switch

The Time-limited OFF function enables automatic switch off after a programmable Time-limited OFF time. The output works as a normal switch actuator but is switched off after a given time for security.

Example: Attic, the lighting can be switched normally but switches off after not more than 3 hours.

Parameter	Description	Value
Additional time limited toggle switch function	The parameters for setting the Time-limited OFF time are: Hidden. Displayed.	Not active* Active

Function diagram

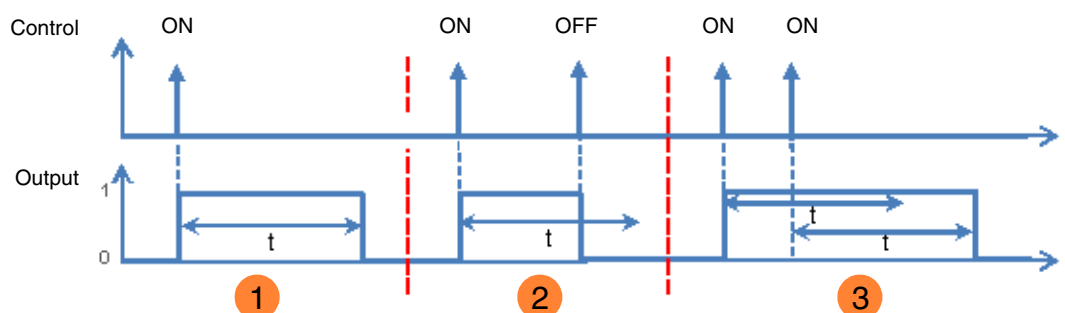

- 1 Emission of an ON command: The output which is at ON will switch to OFF on expiry of the Time-limited OFF time.
- 2 Emission of an ON command: The output switches to ON.
Emission of an OFF command before expiry of the Time-limited OFF time, t : The output switches to OFF.
- 3 Emission of an ON command: The output switches to ON.
Emission of an ON command before expiry of the Time-limited OFF time, t : The output remains at ON and the Time-limited OFF time, t , is re-started.

* Default value

- Communication objects:
- 2 - Output 1 - Time limited toggle switch object (1 bit - 1.001 DPT_Switch)
 - 22 - Output 2 - Time limited toggle switch object (1 bit - 1.001 DPT_Switch)
 - 42 - Output 3 - Time limited toggle switch object (1 bit - 1.001 DPT_Switch)
 - 62 - Output 4 - Time limited toggle switch object (1 bit - 1.001 DPT_Switch)
 - 82 - Output 5 - Time limited toggle switch object (1 bit - 1.001 DPT_Switch)
 - 102 - Output 6 - Time limited toggle switch object (1 bit - 1.001 DPT_Switch)
 - 122 - Output 7 - Time limited toggle switch object (1 bit - 1.001 DPT_Switch)
 - 142 - Output 8 - Time limited toggle switch object (1 bit - 1.001 DPT_Switch)
 - 162 - Output 9 - Time limited toggle switch object (1 bit - 1.001 DPT_Switch)
 - 182 - Output 10 - Time limited toggle switch object (1 bit - 1.001 DPT_Switch)

Parameter	Description	Value
Hours (h)	This parameter sets the length of the timer operation for the Time-limited toggle switch, if this is activated.	1 hours: 0 to 23 h
Minutes (min)		0 minutes: 0 to 59 min
Seconds (s)		0 seconds: 0 to 59 s

Note: The smallest executable time is 1 second.

Note: This parameter is only visible if the **Additional time limited toggle switch function** parameter has the following value: **Active**.

3.8.3 Timer

The Timer function can switch a lighting circuit on or off for a configurable period. According to the selected operating mode of the timer, the output can be turned ON or OFF for a determined period of time. The timer may be interrupted before expiry of the delay time. A programmable Cut-OFF pre-warning announces the end of the delay time by a 1-second inversion of the output status.

Device: 1.1.2 10-fold switch actuator 4A 230V AC

Outputs 1-10: Function selection	Timer operation	ON
- O1-10: Manual mode ON/OFF	Timer duration (h)	0
- O1-10: Status indications ON/OFF	Timer duration (min)	3
Output 1: Function selection	Timer duration (s), minimum value 1s	0
- O1: Timer	Cut-OFF pre-warning	Active
Output 2: Function selection	Hours (h)	0
Output 3: Function selection	Minutes (min)	0
Output 4: Function selection	Seconds (s)	30
Output 5: Function selection	Timer interruption	Yes
Output 6: Function selection	Timer retriggerability	Yes
Output 7: Function selection	Timer duration extension (10 first seconds)	Unlimited
Output 8: Function selection	Timer duration modifiable through object	Not active
Output 9: Function selection		
Output 10: Function selection		
Information		

3.8.3.1 Timer operation

Parameter	Description	Value
Timer operation	When the timer is active, the output for the Timer duration is: Selectively switched on. Selectively switched off. Switched alternately ON and OFF. (Blink time is configurable via additional parameters.)	ON* OFF Blinking

Parameter	Description	Value
Hours (h)	This parameter determines the timer duration.	0 hours: 0 to 23 h
Minutes (min)		2 minutes: 0 to 59 min
Seconds (s)		0 seconds: 0 to 59 s

Note: The smallest executable time is 1 second.

Parameter	Description	Value
Blinking ON duration (s)	This parameter determines the closing duration of the output contact when blinking.	5 seconds: 5 to 240 s

Note: This parameter is only visible if the **Timer operation** parameter has the following value: **Blinking**.

Parameter	Description	Value
Blinking OFF duration (s)	This parameter determines the opening duration of the output contact when blinking.	5 seconds: 5 to 240 s

Note: This parameter is only visible if the **Timer operation** parameter has the following value: **Blinking**.

Parameter	Description	Value
Output status during blinking function	When the switch actuator is blinking, the Status indication ON/OFF object sends: The value, 1 = ON. The value, 0 = OFF. The values 1 and 0 alternately. (The status object blinks accordingly.)	ON* OFF ON/OFF

Note: This parameter is only visible if the **Timer operation** parameter has the following value: **Blinking**.

* Default value

3.8.3.2 Cut-OFF pre-warning

Parameter	Description	Value
Cut-OFF pre-warning	Before expiry of the timer delay there is: No warning. A warning through a 1-second inversion of the output status. The lead time of this warning can be set.	Not active Active*

Parameter	Description	Value
Hours (h)	This parameter determines the lead time of the cut-OFF pre-warning.	0 hours: 0 to 23 h
Minutes (min)		0 minutes: 0 to 59 min
Seconds (s)		30 seconds: 0 to 59 s

Note: The smallest executable time is 1 second.

*Note: This parameter is only visible if the **Cut-OFF pre-warning** parameter has the following value: **Active**.*

Note: If the lead time of the cut-OFF pre-warning is greater than the duration of the timer, the cut-OFF pre-warning is not triggered.

3.8.3.3 Configuration

Parameter	Description	Value
Timer interruption	On receiving the value 0 on the Timer communication object, the timing is: Interrupted. Not interrupted.	Yes* No

Parameter	Description	Value
Timer retriggerability	The parameter Timer duration extension (10 first seconds) is: Hidden. Displayed.	No Yes*

* Default value

Parameter	Description	Value
Timer duration extension (10 first seconds)	<p>If, during the first 10 seconds of the timer duration, multiple commands with the value 1 are received on the Timer communication object, it is:</p> <p>Multiplied unlimited times.</p> <p>Multiplied a maximum of 1x.</p> <p>Multiplied a maximum of 2x.</p> <p>Multiplied a maximum of 3x.</p> <p>Multiplied a maximum of 4x.</p> <p>Multiplied a maximum of 5x.</p>	<p>Unlimited*</p> <p>1-time duration extension</p> <p>2-time duration extension</p> <p>3-time duration extension</p> <p>4-time duration extension</p> <p>5-time duration extension</p>

Parameter	Description	Value
Timer duration modifiable through object	<p>The Timer duration communication object is:</p> <p>Hidden.</p> <p>Displayed, the timer duration can be transmitted via the bus.</p>	<p>Not active*</p> <p>Active</p>

Communication objects:

- [5 - Output 1 - Timer duration \(3 byte - 10.001 DPT_TimeOfDay\)](#)
- [25 - Output 2 - Timer duration \(3 byte - 10.001 DPT_TimeOfDay\)](#)
- [45 - Output 3 - Timer duration \(3 byte - 10.001 DPT_TimeOfDay\)](#)
- [65 - Output 4 - Timer duration \(3 byte - 10.001 DPT_TimeOfDay\)](#)
- [85 - Output 5 - Timer duration \(3 byte - 10.001 DPT_TimeOfDay\)](#)
- [105 - Output 6 - Timer duration \(3 byte - 10.001 DPT_TimeOfDay\)](#)
- [125 - Output 7 - Timer duration \(3 byte - 10.001 DPT_TimeOfDay\)](#)
- [145 - Output 8 - Timer duration \(3 byte - 10.001 DPT_TimeOfDay\)](#)
- [165 - Output 9 - Timer duration \(3 byte - 10.001 DPT_TimeOfDay\)](#)
- [185 - Output 10 - Timer duration \(3 byte - 10.001 DPT_TimeOfDay\)](#)

* Default value

3.8.4 Scene

Device: 1.1.2 10-fold switch actuator 4A 230V AC

Outputs 1-10: Function selection	Number of scenes used	8
Outputs 1-10: Function selection	Scenes memorisation by long key press	Active
- O1-10: Manual mode ON/OFF	Scenes memorisation acknowledgment (Output status inversed for 3s)	Not active
- O1-10: Status indications ON/OFF		
Output 1: Function selection	Output status for scene 1	Not active
- O1: Scenes	Output status for scene 2	Not active
Output 2: Function selection	Output status for scene 3	Not active
Output 3: Function selection	Output status for scene 4	Not active
Output 4: Function selection	Output status for scene 5	Not active
Output 5: Function selection	Output status for scene 6	Not active
Output 6: Function selection	Output status for scene 7	Not active
Output 7: Function selection	Output status for scene 8	Not active
Output 8: Function selection		
Output 9: Function selection	Blinking ON duration (s)	5
Output 10: Function selection	Blinking OFF duration (s)	5
Information	Output status during blinking function	ON

Parameter	Description	Value
Number of scenes used	This parameter determines the number of scenes used.	8* - 16 - 24 - 32 - 48 - 64

Note: If the Scene number received on the Scene object is greater than the maximum number of scenes, the status of the output remains unchanged.

Parameter	Description	Value
Scenes memorisation by very long key press	This parameter allows learning and storing of a scene by, for example, a long press (> 5 seconds) of the corresponding push button.	Not active Active*

Learning and storing scenes

This process is used to change and store a scene. For example, by locally pressing the key in the room or by emission of the values from a visualization.

* Default value

To access and store scenes, the following values must be sent:

Scene number	Access scene (Object value: 1 byte)	Store scene (Object value: 1 byte)
1 - 64	= Scene number - 1	= Scene number + 128
Example		
1	0	128
2	1	129
3	2	130
...	...	
64	63	191

Here is the scene memorisation for local switches, for example.

- Activate scene by briefly pressing the transmitter that starts it.
- The outputs (lights, shutters, etc.) are set in the desired state using the usual local control devices (buttons, remote control, etc.).
- Memorise the status of the outputs with a press greater than 5 seconds long on the transmitter that starts the scene. The memorisation can be displayed by short-term activation of the outputs.

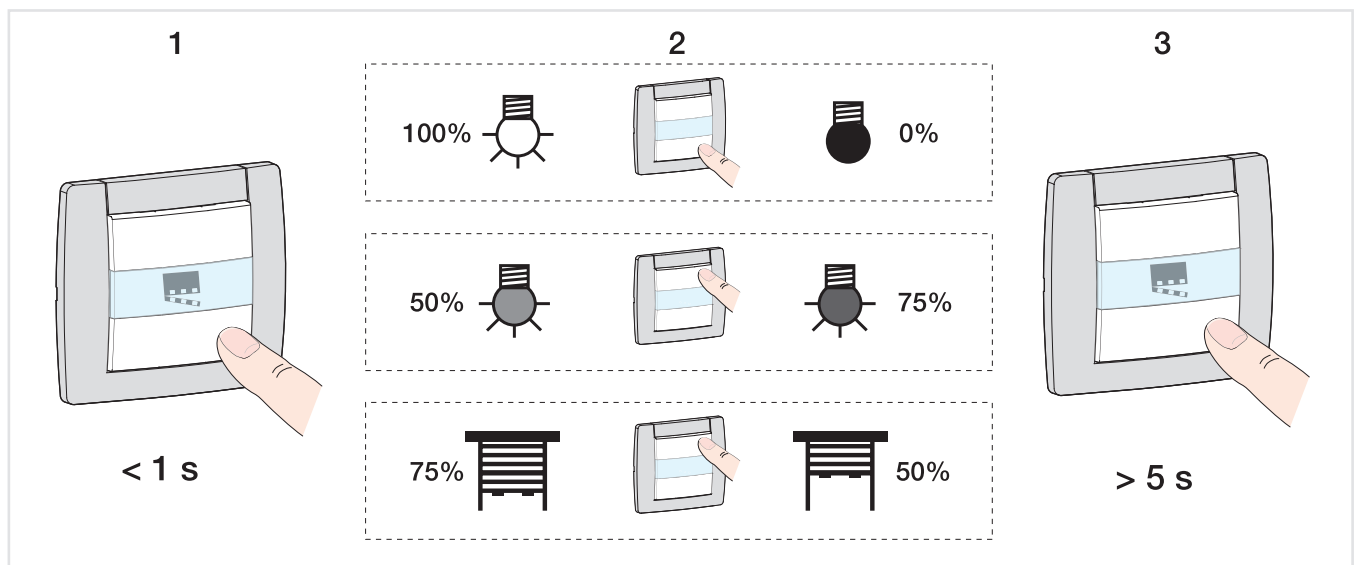

Parameter	Description	Value
Scenes memorisation acknowledgment	Memorisation of a scene is: Not acknowledged. Acknowledged by the output by a 3 second long inversion of the output status.	Not active* Active

* Default value

Parameter	Description	Value
Output status for scene X	On activation of Scene X, the output is: Not changed. Selectively switched on. Selectively switched off. Switched alternately ON and OFF. (Blink time is configurable via additional parameters.)	Not active* ON OFF Blinking

X = 1 to 64

*Note: Each output has up to 64 scenes available, in accordance with the **Number of scenes used** parameter.*

*Note: Local storage of the scene is not recorded if the **Output status for scene X** parameter is not active or is blinking.*

Parameter	Description	Value
Blinking ON duration (s)	This parameter determines the closing duration of the output contact when blinking.	5 seconds: 5 to 240 s

*Note: This parameter applies to all scenes involving the respective output, which has the following value: **Blinking**.*

Parameter	Description	Value
Blinking OFF duration (s)	This parameter determines the opening duration of the output contact when blinking.	5 seconds: 5 to 240 s

*Note: This parameter applies to all scenes involving the respective output, which has the following value: **Blinking**.*

Parameter	Description	Value
Output status during blinking function	When the switch actuator is blinking, the Status indication ON/OFF object sends: The value, 1 = ON. The value, 1 = OFF. The values 1 and 0 alternately. (The status object blinks accordingly.)	ON* OFF ON/OFF

*Note: This parameter applies to all scenes involving the respective output, which has the following value: **Blinking**.*

* Default value

3.8.5 Preset

Device: 1.1.2 10-fold switch actuator 4A 230V AC

Outputs 1-10: Function Outputs 1-10: Function selection - O1-10: Manual mode ON/OFF - O1-10: Status indications ON/OFF Output 1: Function selection - O1: Preset Output 2: Function selection Output 3: Function selection Output 4: Function selection Output 5: Function selection Output 6: Function selection Output 7: Function selection Output 8: Function selection Output 9: Function selection Output 10: Function selection Information	Preset authorization objects Active Value of authorization preset 1 at initialization Value before initialization Value of authorization preset 2 at initialization Value before initialization Polarity of Preset 1 authorization object 0 = Locked-up , 1 = Authorized Polarity of Preset 2 authorization object 0 = Locked-up , 1 = Authorized Status if preset 1 object = 0 Scene number Scene for preset 1 = 0 1 Status if preset 1 object = 1 Blinking Blinking ON duration (s) 5 Blinking OFF duration (s) 5 Output status during blinking function ON Status if preset 2 object = 0 Maintain status Status if preset 2 object = 1 Maintain status
--	---

The Preset function is used to switch an output into various predefined states. The Preset function is activated via an object in 1-bit format.

Principle of Preset authorization:

The parameters are set as follows:

- Polarity of Preset 1 authorization object: 0 = Locked-up, 1 = Authorized.
- Polarity of Preset 2 authorization object: 0 = Locked-up, 1 = Authorized.
- Status if preset 1 object = 0: ON.
- Status if preset 1 object = 1: OFF.
- Status if preset 2 object = 0: Scene 1.
- Status if preset 2 object = 1: Scene 2.

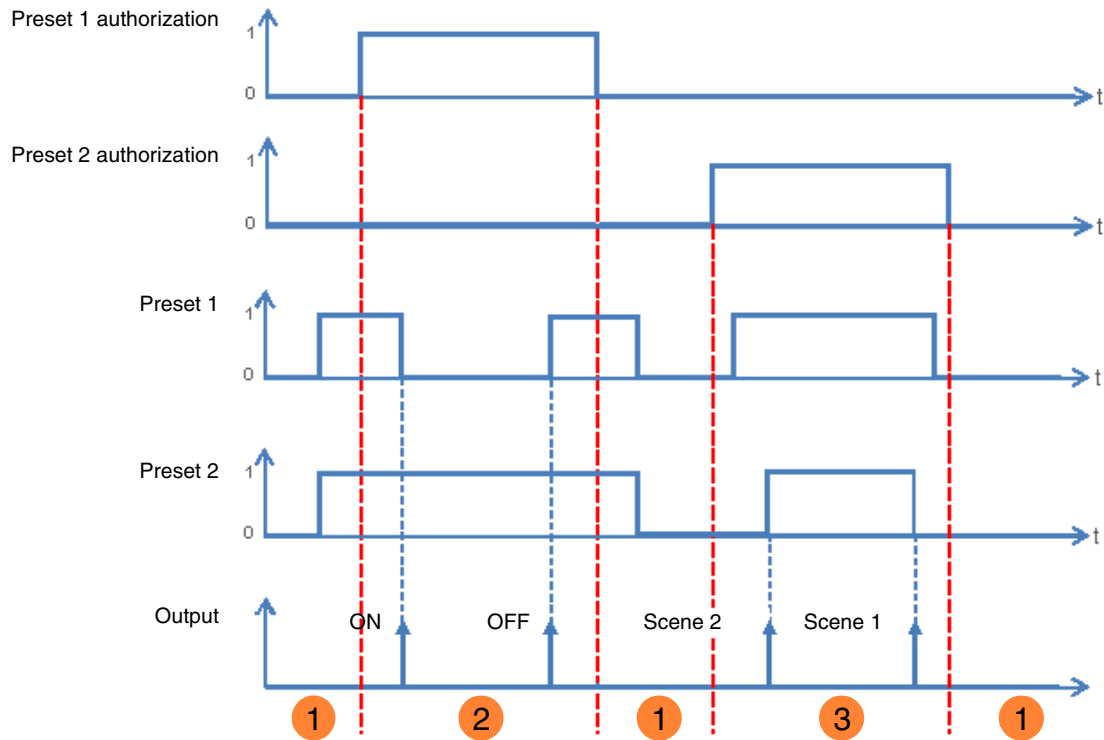

- ❶ The preset inputs have no influence on the output.
- ❷ The commands from Preset 1 are executed.
- ❸ The commands from Preset 2 are executed.

Note: The commands from the Preset will not be executed immediately after authorization, but only when the value of the Preset changes.

Parameter	Description	Value
Preset authorization objects	<p>The Preset 1 authorization communication object and the related parameters are:</p> <p>Hidden.</p> <p>Displayed.</p> <p>This object allows the authorization or lock-up of the Preset 1 function via a KNX telegram.</p>	<p>Not active*</p> <p>Active</p>

*Note: The number of available Preset objects is dependent on the **Preset** parameter. A maximum of two of these objects can be available.*

* Default value

Communication objects:

- 9 - Output 1 - Preset 1 authorization (1 bit - 1.003 DPT_Enable)
- 29 - Output 2 - Preset 1 authorization (1 bit - 1.003 DPT_Enable)
- 49 - Output 3 - Preset 1 authorization (1 bit - 1.003 DPT_Enable)
- 69 - Output 4 - Preset 1 authorization (1 bit - 1.003 DPT_Enable)
- 89 - Output 5 - Preset 1 authorization (1 bit - 1.003 DPT_Enable)
- 109 - Output 6 - Preset 1 authorization (1 bit - 1.003 DPT_Enable)
- 129 - Output 7 - Preset 1 authorization (1 bit - 1.003 DPT_Enable)
- 149 - Output 8 - Preset 1 authorization (1 bit - 1.003 DPT_Enable)
- 169 - Output 9 - Preset 1 authorization (1 bit - 1.003 DPT_Enable)
- 189 - Output 10 - Preset 1 authorization (1 bit - 1.003 DPT_Enable)

Communication objects:

- 10 - Output 1 - Preset 2 authorization (1 bit - 1.003 DPT_Enable)
- 30 - Output 2 - Preset 2 authorization (1 bit - 1.003 DPT_Enable)
- 50 - Output 3 - Preset 2 authorization (1 bit - 1.003 DPT_Enable)
- 70 - Output 4 - Preset 2 authorization (1 bit - 1.003 DPT_Enable)
- 90 - Output 5 - Preset 2 authorization (1 bit - 1.003 DPT_Enable)
- 110 - Output 6 - Preset 2 authorization (1 bit - 1.003 DPT_Enable)
- 130 - Output 7 - Preset 2 authorization (1 bit - 1.003 DPT_Enable)
- 150 - Output 8 - Preset 2 authorization (1 bit - 1.003 DPT_Enable)
- 170 - Output 9 - Preset 2 authorization (1 bit - 1.003 DPT_Enable)
- 190 - Output 10 - Preset 2 authorization (1 bit - 1.003 DPT_Enable)

Note: The parameters and objects are identical for Preset 2 ; Only the terms will be adjusted.

Parameter	Description	Value
Value of authorization preset 1 at initialization	On initialization of the device after a download or after return of the bus power, the value of the Preset 1 authorization object is: Set to 0. Set to 1. Set according to the value of the logic input before the initialization occurred.	0 1 Value before initialization*

Note: This parameter is only visible if the **Preset authorization objects** parameter has the following value: **Active**.

Parameter	Description	Value
Polarity of Preset 1 authorization object	On receipt of a value on the Preset 1 authorization object, Preset 1 : Locked-up on object value 1. Locked-up on object value 0.	0 = Locked-up, 1 = Authorized* 0 = Authorized, 1 = Locked-up

Note: This parameter is only visible if the **Preset authorization objects** parameter has the following value: **Active**.

* Default value

Parameter	Description	Value
Status if preset 1 object = 0	On receipt of the value 0 on the Preset 1 object, the output is: Not changed. Is switched to the opposite status. Selectively switched on. Selectively switched off. Set to a scene value. Set in blinking mode. Switched to the status that was active before last receiving the value 1 on the Preset 1 object.	Maintain status* Inversion ON OFF Scene number Blinking Status before preset 1 = 1

Parameter	Description	Value
Scene for preset 1 = 0	This parameter determines the value of the scene if: The Preset 1 object has value 0. The Status if preset 1 object = 0 object has the scene value.	Scene 1 ... 64 Default value: 1

Parameter	Description	Value
Status if preset 1 object = 1	On receipt of the value 1 on the Preset 1 object, the output is: Not changed. Is switched to the opposite status. Selectively switched on. Selectively switched off. Set to a scene value. Set in blinking mode. Switched to the status that was active before last receiving the value 1 on the Preset 1 object.	Maintain status* Inversion ON OFF Scene number Blinking Status before preset 1 = 0

Parameter	Description	Value
Scene for preset 1 = 1	This parameter determines the value of the scene if: The Preset 1 object has value 1. The Status if preset 1 object = 1 object has the scene value.	Scene 1 ... 64 Default value: Scene 2

Parameter	Description	Value
Blinking ON duration (s)	This parameter determines the closing duration of the output contact when blinking.	5 seconds: 5 to 240 s

*Note: This parameter is only visible if the **Status if preset 1 object = 0** parameter or the **Status if preset 1 object = 1** parameter has the following value: **Blinking**.*

* Default value

Parameter	Description	Value
Blinking OFF duration (s)	This parameter determines the opening duration of the output contact when blinking.	5 seconds: 5 to 240 s

*Note: This parameter is only visible if the **Status if preset 1 object = 0** parameter or the **Status if preset 1 object = 1** parameter has the following value: **Blinking**.*

Parameter	Description	Value
Output status during blinking function	When the switch actuator is blinking, the Status indication ON/OFF object sends: The value, 1 = ON. The value, 0 = OFF. The values 1 and 0 alternately. (The status object blinks accordingly.)	ON* OFF ON/OFF

*Note: This parameter is only visible if the **Status if preset 1 object = 0** parameter or the **Status if preset 1 object = 1** parameter has the following value: **Blinking**.*

* Default value

3.8.6 Lock-up

Device: 1.1.2 10-fold switch actuator 4A 230V AC

<ul style="list-style-type: none"> Outputs 1-10: Function Outputs 1-10: Function selection - O1-10: Manual mode ON/OFF - O1-10: Status indications ON/OFF Output 1: Function selection - O1: Lock-up Output 2: Function selection Output 3: Function selection Output 4: Function selection Output 5: Function selection Output 6: Function selection Output 7: Function selection Output 8: Function selection Output 9: Function selection Output 10: Function selection Information 	<p>Lock-up type: <input type="text" value="Output lock-up"/></p> <p>Lock-up duration: <input type="text" value="Permanently"/></p> <p>Polarity of lock-up object 1: <input type="text" value="0 = Lock-up deactivated, 1 = Lock-up activated"/></p> <p>Polarity of lock-up object 2: <input type="text" value="0 = Lock-up deactivated, 1 = Lock-up activated"/></p> <p>Priority between lock-up 1 and lock-up 2: <input type="text" value="Lock-up 1 > Lock-up 2"/></p> <p>Status if lock-up 1: <input type="text" value="Maintain status"/></p> <p>Status if lock-up 2: <input type="text" value="Maintain status"/></p> <p>Status after lock-up function 1: <input type="text" value="Maintain status"/></p> <p>Status after lock-up function 2: <input type="text" value="Maintain status"/></p> <p>Activation of lock-up status object: <input type="text" value="Active"/></p> <p>Polarity: <input type="text" value="0 = Lock-up deactivated, 1 = Lock-up activated"/></p> <p>Emission: <input type="text" value="On status change and periodically"/></p> <p>Hours (h): <input type="text" value="0"/></p> <p>Minutes (min): <input type="text" value="10"/></p> <p>Seconds (s): <input type="text" value="0"/></p>
---	--

The Lock-up function is used to lock the output in a predefined state.
 Priority: Manual mode > Priority > **Lock-up** > Basic function.
 The Lock-up prevents actuation until an unlock command has been received.
 The Lock-up duration can be set.

Parameter	Description	Value
Lock-up type	<p>The Lock-up acts:</p> <p>Directly on the switch actuator. As long as the Lock-up is active, the output can only be controlled by higher priority commands.</p> <p>On selected communication objects. As long as the Lock-up is active, the output can only be controlled via specific selectable objects.</p>	<p>Output lock-up*</p> <p>Object lock-up</p>

* Default value

Parameter	Description	Value
Lock-up duration	The duration of the Lock-up is Not time limited, the lock-up is only authorized by means of a telegram on Lock-up 1 object. Is active for a limited time, the control of the output is authorized after expiry of this time.	Permanently* Time limited

Parameter	Description	Value
Hours (h)	This parameter determines the activation time of the Lock-up.	0 hours: 0 to 23 h
Minutes (min)		15 minutes: 0 to 59 min
Seconds (s)		0 seconds: 0 to 59 s

Note: The smallest executable time is 1 second.

Note: This parameter is only visible if the **Lock-up duration** parameter has the following value: **Time limited**.

Parameter	Description	Value
Polarity of lock-up object 1	On receipt of a value on the Lock-up 1 object, the lock-up: Locked-up on object value 1. Is deactivated on object value 0. Locked-up on object value 0. Is deactivated on object value 1.	0 = Lock-up deactivated, 1 = Lock-up activated* 0 = Lock-up activated, 1 = Lock-up deactivated

Note: The parameters and objects are identical for Lock-up 2 ; Only the terms will be adjusted.

Parameter	Description	Value
Priority between lock-up 1 and lock-up 2	The priority between lock-up 1 and lock-up 2 is set as follows: Lock-up 1 has priority over lock-up 2. Lock-up 2 has priority over lock-up 1. Lock-up 1 and lock-up 2 have the same priority.	Lock-up 1 > Lock-up 2* Lock-up 1 < Lock-up 2 Lock-up 1 = Lock-up 2

Note: This parameter is only visible if the **Lock-up** parameter has the following value: **Active with 2 lock-up objects**.

Note: The priority of the Lock-up always functions in the same way, independently of the lock-up type (Output lock-up or object lock-up).

* Default value

Operating principle of the priorities:
If Lock-up 1 > Lock-up 2

Active lock-up	Activation order of Lock-up 1	Activation order of Lock-up 2
None	Lock-up 1 is activated	Lock-up 2 is activated
Lock-up 1	Lock-up 1 remains active	Despite the activation order of Lock-up 2, Lock-up 1 remains activated
Lock-up 2	Lock-up 1 is activated	Lock-up 2 remains active

If Lock-up 1 = Lock-up 2

Active lock-up	Activation order of Lock-up 1	Activation order of Lock-up 2
None	Lock-up 1 is activated	Lock-up 2 is activated
Lock-up 1	Lock-up 1 remains active	Lock-up 2 is activated
Lock-up 2	Lock-up 1 is activated	Lock-up 2 remains active

If Lock-up 1 < Lock-up 2

Active lock-up	Activation order of Lock-up 1	Activation order of Lock-up 2
None	Lock-up 1 is activated	Lock-up 2 is activated
Lock-up 1	Lock-up 1 remains active	Lock-up 2 is activated
Lock-up 2	Despite the activation order of Lock-up 1, Lock-up 2 remains activated	Lock-up 2 remains active

Parameter	Description	Value
Status if lock-up 1	If the Lock-up type is set to Output lock-up , on activation of the lock-up the output will: Not changed. Switch to the opposite status. Selectively switched on. Selectively switched off.	Maintain status* Inversion ON OFF

Note: The parameters and objects are identical for Lock-up 2 ; Only the terms will be adjusted.

Lock-up 1 authorizes object:

The parameters listed below allow the selection of the objects for controlling the output via the nevertheless active Lock-up.

*Note: These parameters are only visible if the **Lock-up type** parameter has the following value: **Object lock-up**.*

* Default value

Parameter	Objects concerned	Value
ON/OFF	ON/OFF	Yes No*
Scene	Scene	Yes No*
Timer	Timer	Yes No*
Timer/toggle switch changeover	Timer/toggle switch changeover	Yes No*
Time limited toggle switch	Time limited toggle switch object	Yes No*
Preset 1	Preset 1	Yes No*
Preset 2	Preset 2	Yes No*

Note: The parameters and objects are identical for Lock-up 2 ; Only the terms will be adjusted.

Parameter	Description	Value
Status after lock-up function 1	<p>If the Lock-up type is set to Output lock-up, on cancellation of the lock-up the output will:</p> <p>Not changed.</p> <p>Switch to the opposite status.</p> <p>Selectively switched on.</p> <p>Selectively switched off.</p> <p>Return to the status that was active before the lock-up.</p>	<p>Maintain status*</p> <p>Inversion</p> <p>ON</p> <p>OFF</p> <p>Status before lock-up 1</p>

Note: The application of this parameter depends on the priority of the other active functions. If a function with higher priority is active, this parameter will not be enacted. In the case where two functions with the same priority are active, the parameter of the most recently switched off function is enacted.

Note: The parameters and objects are identical for Lock-up 2 ; Only the terms will be adjusted.

Parameter	Description	Value
Activation of lock-up status object	<p>The Status indication lock-up communication object is hidden.</p> <p>The Status indication lock-up communication object is displayed.</p>	<p>Not active*</p> <p>Active</p>

* Default value

- Communication objects:
- 13 - Output 1 - Status indication lock-up (1 bit - 1.011 DPT_State)
 - 33 - Output 2 - Status indication lock-up (1 bit - 1.011 DPT_State)
 - 53 - Output 3 - Status indication lock-up (1 bit - 1.011 DPT_State)
 - 73 - Output 4 - Status indication lock-up (1 bit - 1.011 DPT_State)
 - 93 - Output 5 - Status indication lock-up (1 bit - 1.011 DPT_State)
 - 113 - Output 6 - Status indication lock-up (1 bit - 1.011 DPT_State)
 - 133 - Output 7 - Status indication lock-up (1 bit - 1.011 DPT_State)
 - 153 - Output 8 - Status indication lock-up (1 bit - 1.011 DPT_State)
 - 173 - Output 9 - Status indication lock-up (1 bit - 1.011 DPT_State)
 - 193 - Output 10 - Status indication lock-up (1 bit - 1.011 DPT_State)

Parameter	Description	Value
Polarity	The Status indication Lock-up communication object sends: 0 on deactivation of the lock-up. 1 on activation of the lock-up. 0 on activation of the lock-up. 1 on deactivation of the lock-up.	0 = Lock-up deactivated, 1 = Lock-up activated* 0 = Lock-up activated, 1 = Lock-up deactivated

Parameter	Description	Value
Emission	The Status indication lock-up communication object is sent: On activation and deactivation of the lock-up. Periodically after a configurable time. On activation and deactivation of the lock-up and periodically after a configurable time.	On status change* Periodically On status change and periodically

Note: This parameter is only visible if the **Activation of Lock-up status object** parameter has the following value: **Active**.

Parameter	Description	Value
Hours (h)	This parameter determines the time between the individual transmissions of the Status indication lock-up object.	0 hours: 0 to 23 h
Minutes (min)		10 minutes: 0 to 59 min
Seconds (s)		0 seconds: 0 to 59 s

Note: The smallest executable time is 1 second.

Note: This parameter is only visible if the **Emission** parameter has the following value: **Periodically** or **On status change and periodically**.

* Default value

3.8.7 Priority

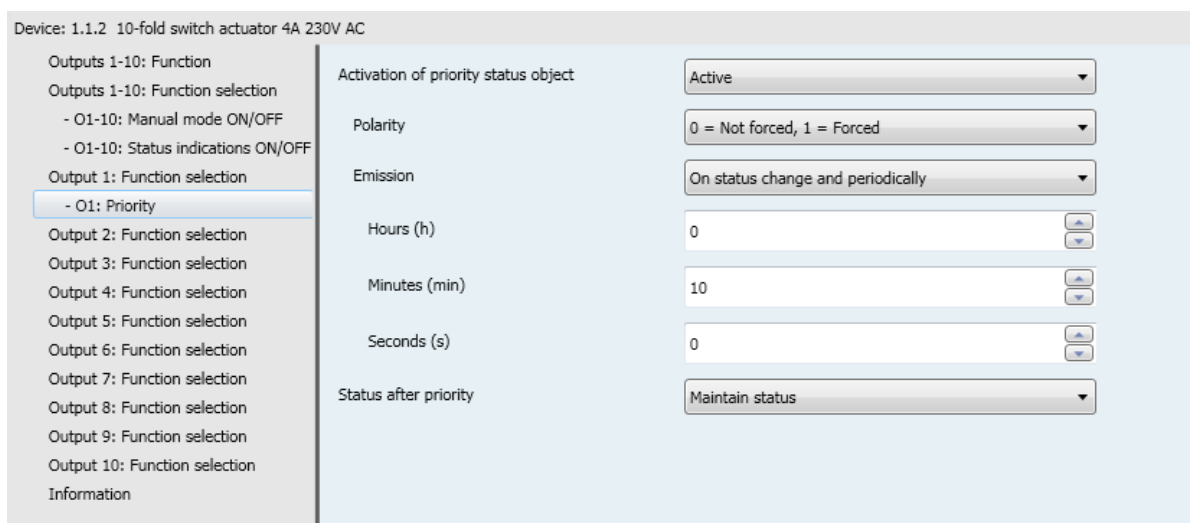

The Priority is used to force the output into a predefined state.

Priority: Manual mode > **Priority** > Lock-up > Basic function.

No other command is taken into account when the Priority is active. Only by ending the Priority are other commands again permitted.

Parameter	Description	Value
Activation of priority status object	The Status indication priority communication object and related parameters are hidden.	Not active*
	The Status indication priority communication object and related parameters are displayed.	Active

Communication objects:

- 15 - Output 1 - Status indication priority** (1 bit - 1.011 DPT_State)
- 35 - Output 2 - Status indication priority** (1 bit - 1.011 DPT_State)
- 55 - Output 3 - Status indication priority** (1 bit - 1.011 DPT_State)
- 75 - Output 4 - Status indication priority** (1 bit - 1.011 DPT_State)
- 95 - Output 5 - Status indication priority** (1 bit - 1.011 DPT_State)
- 115 - Output 6 - Status indication priority** (1 bit - 1.011 DPT_State)
- 135 - Output 7 - Status indication priority** (1 bit - 1.011 DPT_State)
- 155 - Output 8 - Status indication priority** (1 bit - 1.011 DPT_State)
- 175 - Output 9 - Status indication priority** (1 bit - 1.011 DPT_State)
- 195 - Output 10 - Status indication priority** (1 bit - 1.011 DPT_State)

Parameter	Description	Value
Polarity	The Status indication priority communication object sends: 0 on deactivation of the Priority. 1 on activation of the Priority. 0 on activation of the Priority. 1 on deactivation of the Priority.	0 = Not forced, 1 = Forced* 0 = Forced, 1 = Not forced

*Note: This parameter is only visible if the **Activation of priority status object** parameter has the following value: **Active**.*

* Default value

Parameter	Description	Value
Emission	The Status indication priority communication object is sent: On activation and deactivation of the Priority. Periodically after a configurable time. On activation and deactivation of the Priority and periodically after a configurable time.	On status change* Periodically On status change and periodically

Note: This parameter is only visible if the **Activation of priority status object** parameter has the following value: **Active**.

Parameter	Description	Value
Hours (h)	This parameter determines the time between the individual transmissions of the Status indication priority object.	0 hours: 0 to 23 h
Minutes (min)		10 minutes: 0 to 59 min
Seconds (s)		0 seconds: 0 to 59 s

Note: The smallest executable time is 1 second.

Note: This parameter is only visible if the **Emission** parameter has the following value: **Periodically** or **On status change and periodically**.

Parameter	Description	Value
Status after priority	At the end of the priority, the output is: Not changed. Switch to the opposite status. Selectively switched on. Selectively switched off. Switched back to the status before priority was activated. Switched to the status which would be active according to other communication objects if the priority had not taken place.	Maintain status* Inversion ON OFF Status before priority Theoretical status without priority

Note: The application of this parameter depends on the priority of the other active functions. If a function with higher priority is active, this parameter will not be enacted. In the case where two functions with the same priority are active, the parameter of the most recently switched off function is enacted.

* Default value

3.8.8 Hours counter

The Hours Counter function is used to count the overall operating time of an output in the ON or OFF state. The operating hours counter setpoint can be programmed and altered via an object.

Device: 1.1.2 10-fold switch actuator 4A 230V AC

Outputs 1-10: Function selection	Relay status for operating hours counter	Closed
Outputs 1-10: Function selection - O1-10: Manual mode ON/OFF - O1-10: Status indications ON/OFF	Hours counter direction	Increment
Output 1: Function selection - O1: Hours counter	Operating h. counter setpoint	10000
Output 2: Function selection	Counter setpoint value modifiable through object	Not active
Output 3: Function selection	Emission hours counter value	On status change and periodically
Output 4: Function selection	Value interval (h)	100
Output 5: Function selection	Periodical emission delay (h)	1
Output 6: Function selection	Periodical emission delay (min)	0
Output 7: Function selection	Periodical emission delay (s)	0
Output 8: Function selection	Object emission counter setpoint reached	Periodically
Output 9: Function selection	Periodical emission delay (h)	1
Output 10: Function selection	Periodical emission delay (min)	0
Information	Periodical emission delay (s)	0

Parameter	Description	Value
Relay status for operating hours counter	The hours counter runs if: The output is closed. The output is open.	Closed* Opened

Parameter	Description	Value
Hours counter direction	The hours counter counts: Growing. Decreasing.	Increment* Countdown

* Default value

Increment:

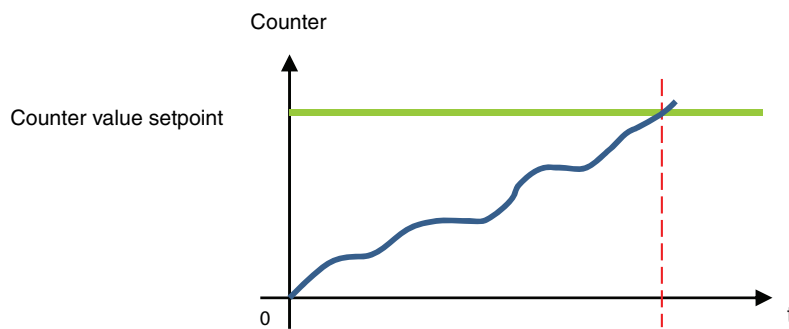

The counter starts to count up from the value 0. As soon as the counter setpoint (**Hours counter setpoint** object) is reached, the **Hours counter setpoint reached** object is set to 1 and sent to the bus.

Countdown:

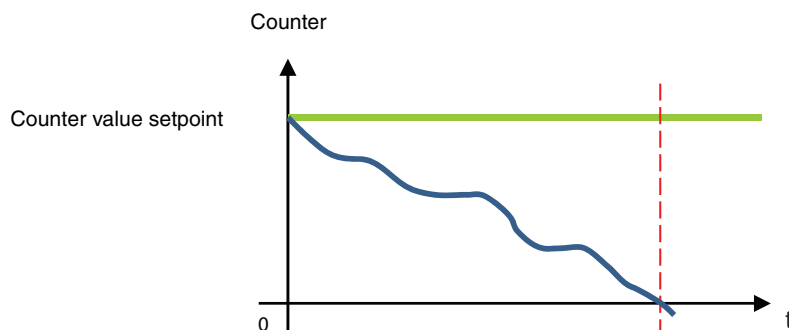

The counter starts to count down from the operating hours counter setpoint (**Hours counter setpoint** object). As soon as the counter reaches 0, the **Hours counter setpoint reached** is set to 1 and sent to the bus.

Parameter	Description	Value
Hours counter setpoint	This parameter determines the value of the hours counter.	1 ... 10000* ... 65535

An incrementing counter starts at 0 and counts up until it reaches the setpoint value.
A countdown counter starts to count at the setpoint value and counts down until it has arrived at 0.

Parameter	Description	Value
Counter setpoint value modifiable through object	The Hours counter setpoint communication object is hidden.	Not active*
	The Hours counter setpoint communication object is displayed. The value can be changed via the KNX bus.	Active

* Default value

- Communication objects:
- 19 - Output 1 - Hours counter setpoint (2 byte - 7.001 DPT_16_bit_Counter)
 - 39 - Output 2 - Hours counter setpoint (2 byte - 7.001 DPT_16_bit_Counter)
 - 59 - Output 3 - Hours counter setpoint (2 byte - 7.001 DPT_16_bit_Counter)
 - 79 - Output 4 - Hours counter setpoint (2 byte - 7.001 DPT_16_bit_Counter)
 - 99 - Output 5 - Hours counter setpoint (2 byte - 7.001 DPT_16_bit_Counter)
 - 119 - Output 6 - Hours counter setpoint (2 byte - 7.001 DPT_16_bit_Counter)
 - 139 - Output 7 - Hours counter setpoint (2 byte - 7.001 DPT_16_bit_Counter)
 - 159 - Output 8 - Hours counter setpoint (2 byte - 7.001 DPT_16_bit_Counter)
 - 179 - Output 9 - Hours counter setpoint (2 byte - 7.001 DPT_16_bit_Counter)
 - 199 - Output 10 - Hours counter setpoint (2 byte - 7.001 DPT_16_bit_Counter)

Parameter	Description	Value
Emission hours counter value	The Hours counter value communication object is sent: On each change. Periodically after a configurable time. On change and periodically after a configurable time.	On status change* Periodically On status change and periodically

Parameter	Description	Value
Value interval (h)	This parameter specifies the value interval (in hours) for the sending frequency of the Hours counter setpoint object.	1 ... 100* ... 65535 (hours)

*Note: If the value interval is 200 hours, then the **Hours counter setpoint** object is sent each time the Operating h. counter value is increased by 200 hours.*

*Note: This parameter is only visible if the **Emission hours counter value** parameter has the following value: **Periodically** or **On status change and periodically**.*

Parameter	Description	Value
Periodical emission delay	This parameter determines the time between the individual transmissions of the Hours counter setpoint object.	1 hours: 0 to 23 h 0 minutes: 0 to 59 min 0 seconds: 0 to 59 s

Note: The smallest executable time is 1 second.

*Note: This parameter is only visible if the **Emission hours counter value** parameter has the following value: **Periodically** or **On status change and periodically**.*

Parameter	Description	Value
Emission object counter setpoint reached	The Hours counter setpoint reached communication object is sent: On reaching the counter setpoint. Periodically after a configurable time. On reaching the counter setpoint and periodically after a configurable time.	On status change Periodically* On status change and periodically

* Default value

Parameter	Description	Value
Periodical emission delay	This parameter determines the time between the individual transmissions of the Hours counter setpoint reached object.	1 hours: 0 to 23 h 0 minutes: 0 to 59 min 0 seconds: 0 to 59 s

Note: The smallest executable time is 1 second.

*Note: This parameter is only visible if the Object **Emission counter setpoint reached** parameter has the following value: **Periodically** or **On status change and periodically**.*

3.9 Functions for each shutter/blind output

Slat position for horizontal slats

The blind drive actuators have 2 limit position switches and can be run to a Sun protection position using a position setting in percent. The value of 0% is used to control the upper position (i.e. Sun protection fully open) or is reported as a status.

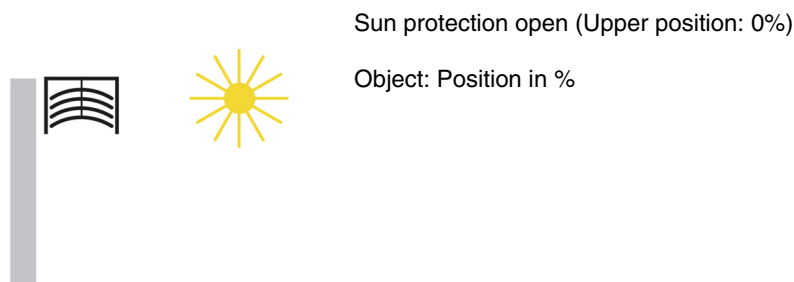

If the lower position is to be approached, then this will be sent to the blinds as Sun protection position 100% or on reaching the lower position (i.e. Sun protection completely closed). The position will be reported using this value. If a blind is run from the upper position, the slats initially tilt into an almost vertical position and then the sun protection runs with closed slats to the lower position.

When the blind is located at the lower position and the slats are fully closed, then this slat position is described as vertical and equal to 100%. Normally, however, fully closed slats have no exactly vertical position ($\alpha = 180^\circ$) but rather form a small angle with the vertical.

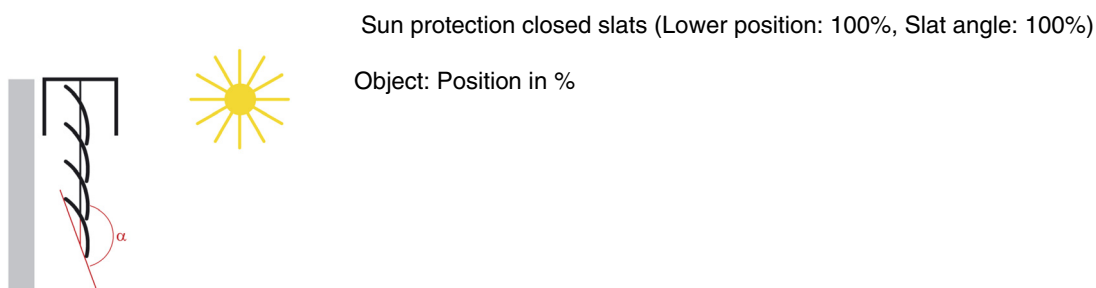

From their vertical position (completely closed, 100%) the slats can be adjusted to their horizontal position (fully open, 0% and $= 90^\circ$) The blind drive used thus determines whether this adjustment can be carried out using many small steps or whether it is only possible via a few large steps (As with most standard drives).



For standard blinds, the slats can be adjusted continuously to the horizontal position or until the slat adjustment ends and the raising of the blind begins. The slats then form an angle of between 0° and 90° with the vertical.

Slat position at the start of moving the blind (Up)

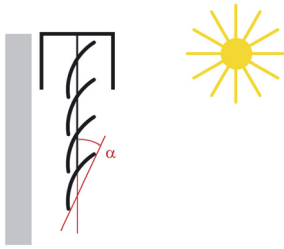

Object: Slat angle in %

Slat position for vertical slats

If an interior shade or privacy shield with vertical slats is controlled via a blind actuator, then the position in which the slats are fully open is controlled or reported as the 0% slat position. The slats then form an angle of 90° with the direction of travel from Shade fully open to Shade fully closed.

Fully opened vertical slats (Slat angle 0%)



Object: Slat angle in %

If the slats are fully closed, this position will be controlled and reported as slat position 100%. This is the position to which the shade is run from its side limit position in front of the window. The angle that the slats then form with the direction of movement is therefore a little > 0°.

Fully closed vertical slats (Slat angle 100%)

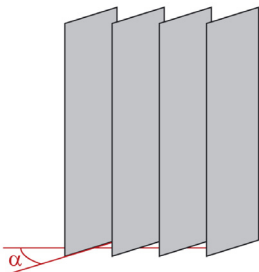

Object: Slat angle in %

If the shade is then driven back (i.e. opened), then the vertical slats are turned to a position that is somewhat smaller than 180°.

Vertical slats at the start of moving UP

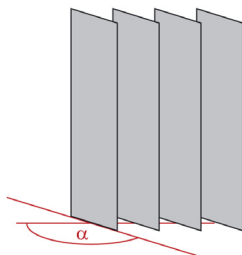

3.9.1 Function selection

These parameters are available individually for each output (Pair).

Device: 1.1.2 10-fold switch actuator 4A 230V AC

- Outputs 1-10: Function
- Outputs 1-10: Function selection
 - O1-10: Manual mode ON/OFF
 - O1-10: Status indications ON/OFF
- Outputs 1-2: Function selection**
- Output 3: Function selection
- Output 4: Function selection
- Output 5: Function selection
- Output 6: Function selection
- Output 7: Function selection
- Output 8: Function selection
- Output 9: Function selection
- Output 10: Function selection
- Information

Closing type for channel 1	Shutter and blind
Complete up movement duration (min)	2
Complete up movement duration (s)	0
Complete down movement duration (min)	2
Complete down movement duration (s)	0
Time delay for direction inversion (ms)	600
Relay closing time for slat positioning (ms)	150
Total number of slat angles	12
Secured down	Not active
Manual mode active for output 1	Yes
Status indication	Yes
Status indication position in %	Active
Status indication slat angle in %	Active
Status indication upper position reached	Not active
Status indication lower position reached	Not active
Scene	Not active
Lock-up	Not active
Preset	Not active
Priority	Not active
Alarm	Not active
Reactivate sun protection	Not active

Parameter	Description	Value
Closing type for channel x	This parameter defines the operating mode used for the affected outputs. An operating mode of the shutter and blind type gives access to additional parameters to control the slat pitch.	Shutter* Shutter and blind

x = 1 to 8

Note: These objects are always visible.

* Default value

Communication objects:	0 - Outputs 1-2 - Up/Down (Long key-press) (1 bit - 1.008 DPT_UpDown)
	40 - Outputs 3-4 - Up/Down (Long key-press) (1 bit - 1.008 DPT_UpDown)
	80 - Outputs 5-6 - Up/Down (Long key-press) (1 bit - 1.008 DPT_UpDown)
	120 - Outputs 7-8 - Up/Down (Long key-press) (1 bit - 1.008 DPT_UpDown)
	160 - Outputs 9-10 - Up/Down (Long key-press) (1 bit - 1.008 DPT_UpDown)
	1 - Outputs 1-2 - Step/stop control (Short press) (1 bit - 1.007 DPT_Step)
	41 - Outputs 3-4 - Step/stop control (Short press) (1 bit - 1.007 DPT_Step)
	81 - Outputs 5-6 - Step/stop control (Short press) (1 bit - 1.007 DPT_Step)
	121 - Outputs 7-8 - Step/stop control (Short press) (1 bit - 1.007 DPT_Step)
	161 - Outputs 9-10 - Step/stop control (Short press) (1 bit - 1.007 DPT_Step)
	2 - Outputs 1-2 - Position in % (1 byte - 5.001 DPT_Scaling)
	42 - Outputs 3-4 - Position in % (1 byte - 5.001 DPT_Scaling)
	82 - Outputs 5-6 - Position in % (1 byte - 5.001 DPT_Scaling)
	122 - Outputs 7-8 - Position in % (1 byte - 5.001 DPT_Scaling)
	162 - Outputs 9-10 - Position in % (1 byte - 5.001 DPT_Scaling)

Note: These objects are only visible if the **Closing type for channel x** parameter has the following value: **Shutter and blind**.

Communication objects:	3 - Outputs 1-2 - Slat angle (0-100%) (1 byte - 5.001 DPT_Scaling)
	43 - Outputs 3-4 - Slat angle (0-100%) (1 byte - 5.001 DPT_Scaling)
	83 - Outputs 5-6 - Slat angle (0-100%) (1 byte - 5.001 DPT_Scaling)
	123 - Outputs 7-8 - Slat angle (0-100%) (1 byte - 5.001 DPT_Scaling)
	163 - Outputs 9-10 - Slat angle (0-100%) (1 byte - 5.001 DPT_Scaling)

Parameter	Description	Value
Complete up movement duration	This parameter defines the time taken, during which the contact must be closed, to reach the upper position.	2 minutes: 0 to 59 min 0 seconds: 0 to 59 s

Note: The smallest executable time is 1 second.

Parameter	Description	Value
Complete down movement duration	This parameter defines the time taken, during which the contact must be closed, to reach the lower position.	2 minutes: 0 to 59 min 0 seconds: 0 to 59 s

Note: The smallest executable time is 1 second.

Parameter	Description	Value
Time delay for direction inversion (ms)	This parameter defines how long the shutter or blind must be stopped before the direction of motion can be reversed. During this time, 2 output contacts are open.	300 ... 600* ... 10000 ms

* Default value

Parameter	Description	Value
Relay closing time for slat positioning (ms)	This parameter defines how long the contacts must be closed in order to perform an elementary angle step for the slats.	50 ... 150* ... 10000 ms

Note: These objects are only visible if the **Closing type for channel x** parameter has the following value: **Shutter and blind**.

Parameter	Description	Value
Total number of slat angles	This parameter defines the total number of elementary slat steps available for adjusting the slats from the inclined downwards position to be inclined upwards position.	1 ... 12* ... 60

Note: Before setting the **Total number of slat angles** parameter, it is essential to first set the closed contact duration for an elementary slat step.

Note: These objects are only visible if the **Closing type for channel x** parameter has the following value: **Shutter and blind**.

Parameter	Description	Value
Secured down	In manual mode, the down contact remains closed only as long as the manual button is being pressed.	Not active* Active

Note: This function is also used in order to give the command to close a swimming pool cover, which for safety reasons also requires a continuous button press.

Parameter	Description	Value
Manual mode active for output X	With this parameter, manual mode can be authorized for the output.	Yes* No

X = 1 to 8

Parameter	Description	Value
Status indication	This parameter allows the display of different status indication objects of the outputs concerned.	Yes* No

Parameter	Description	Value
Status indication position in %	This parameter authorizes the Position in % indication object.	Not active* Active

Communication objects:

4 - Outputs 1-2 - Position in % indication (1 byte - 5.001 DPT_Scaling)

44 - Outputs 3-4 - Position in % indication (1 byte - 5.001 DPT_Scaling)

84 - Outputs 5-6 - Position in % indication (1 byte - 5.001 DPT_Scaling)

124 - Outputs 7-8 - Position in % indication (1 byte - 5.001 DPT_Scaling)

164 - Outputs 9-10 - Position in % indication (1 byte - 5.001 DPT_Scaling)

* Default value

Parameter	Description	Value
Status indication slat angle in %	This parameter authorizes the Slat angle indication in % object.	Not active* Active

Note: This parameter is only visible if the **Closing type for channel x** parameter has the following value: **Shutter and blind**.

Communication objects:

- 5 - Outputs 1-2 - Slat angle indication in % (1 byte - 5.001 DPT_Scaling)
- 45 - Outputs 3-4 - Slat angle indication in % (1 byte - 5.001 DPT_Scaling)
- 85 - Outputs 5-6 - Slat angle indication in % (1 byte - 5.001 DPT_Scaling)
- 125 - Outputs 7-8 - Slat angle indication in % (1 byte - 5.001 DPT_Scaling)
- 165 - Outputs 9-10 - Slat angle indication in % (1 byte - 5.001 DPT_Scaling)

Parameter	Description	Value
Status indication upper position reached	This parameter authorizes the Upper position reached object.	Not active* Active

Communication objects:

- 6 - Outputs 1-2 - Upper position reached (1 bit - 1.002 DPT_Bool)
- 46 - Outputs 3-4 - Upper position reached (1 bit - 1.002 DPT_Bool)
- 86 - Outputs 5-6 - Upper position reached (1 bit - 1.002 DPT_Bool)
- 126 - Outputs 7-8 - Upper position reached (1 bit - 1.002 DPT_Bool)
- 166 - Outputs 9-10 - Upper position reached (1 bit - 1.002 DPT_Bool)

Parameter	Description	Value
Status indication lower position reached	This parameter authorizes the Lower position reached object.	Not active* Active

Communication objects:

- 7 - Outputs 1-2 - Lower position reached (1 bit - 1.002 DPT_Bool)
- 47 - Outputs 3-4 - Lower position reached (1 bit - 1.002 DPT_Bool)
- 87 - Outputs 5-6 - Lower position reached (1 bit - 1.002 DPT_Bool)
- 127 - Outputs 7-8 - Lower position reached (1 bit - 1.002 DPT_Bool)
- 167 - Outputs 9-10 - Lower position reached (1 bit - 1.002 DPT_Bool)

Parameter	Description	Value
Scene	The Scenes tab and the associated parameters and objects are: Hidden. Displayed.	Not active* Active

* Default value

Communication objects:

- 8 - Outputs 1-2 - Scene** (1 byte - 17.001 DPT_SceneNumber)
- 48 - Outputs 3-4 - Scene** (1 byte - 17.001 DPT_SceneNumber)
- 88 - Outputs 5-6 - Scene** (1 byte - 17.001 DPT_SceneNumber)
- 128 - Outputs 7-8 - Scene** (1 byte - 17.001 DPT_SceneNumber)
- 168 - Outputs 9-10 - Scene** (1 byte - 17.001 DPT_SceneNumber)

For configuration see section: [Scene Shutter](#).

Parameter	Description	Value
Lock-up	The Lock-up tab and the associated parameters and objects are: Hidden. Displayed for 1 lock-up object. Displayed for 2 lock-up objects.	Not active* 1 lock-up object 2 lock-up objects

Lock-up 1 communication objects

- 13 - Outputs 1-2 - Lock-up 1** (1 bit - 1.003 DPT_Enable)
- 53 - Outputs 3-4 - Lock-up 1** (1 bit - 1.003 DPT_Enable)
- 93 - Outputs 5-6 - Lock-up 1** (1 bit - 1.003 DPT_Enable)
- 133 - Outputs 7-8 - Lock-up 1** (1 bit - 1.003 DPT_Enable)
- 173 - Outputs 9-10 - Lock-up 1** (1 bit - 1.003 DPT_Enable)

Lock-up 2 communication objects

- 14 - Outputs 1-2 - Lock-up 2** (1 bit - 1.003 DPT_Enable)
- 54 - Outputs 3-4 - Lock-up 2** (1 bit - 1.003 DPT_Enable)
- 94 - Outputs 5-6 - Lock-up 2** (1 bit - 1.003 DPT_Enable)
- 134 - Outputs 7-8 - Lock-up 2** (1 bit - 1.003 DPT_Enable)
- 174 - Outputs 9-10 - Lock-up 2** (1 bit - 1.003 DPT_Enable)

For configuration see section: [Lock-up Shutter](#).

Parameter	Description	Value
Preset	The Preset tab and the associated parameters and objects are: Hidden. Displayed for 1 Preset object. Displayed for 2 Preset objects.	Not active* Active with preset 1-level object Active with preset 2-level objects

Note: When the value of this parameter changes, the associated parameters and group addresses are deleted.

* Default value

Preset 1 communication
Objets

- 9 - Outputs 1-2 - Preset 1** (1 bit - 1.022 DPT_Scene_AB)
- 49 - Outputs 3-4 - Preset 1** (1 bit - 1.022 DPT_Scene_AB)
- 89 - Outputs 5-6 - Preset 1** (1 bit - 1.022 DPT_Scene_AB)
- 129 - Outputs 7-8 - Preset 1** (1 bit - 1.022 DPT_Scene_AB)
- 169 - Outputs 9-10 - Preset 1** (1 bit - 1.022 DPT_Scene_AB)

Preset 2 communication
Objets

- 10 - Outputs 1-2 - Preset 2** (1 bit - 1.022 DPT_Scene_AB)
- 50 - Outputs 3-4 - Preset 2** (1 bit - 1.022 DPT_Scene_AB)
- 90 - Outputs 5-6 - Preset 2** (1 bit - 1.022 DPT_Scene_AB)
- 130 - Outputs 7-8 - Preset 2** (1 bit - 1.022 DPT_Scene_AB)
- 170 - Outputs 9-10 - Preset 2** (1 bit - 1.022 DPT_Scene_AB)

For configuration see section: [Preset Shutter](#).

Parameter	Description	Value
Priority	The Priority tab and the associated parameters and objects are: Hidden. Displayed.	Not active* Active

The device responds to telegrams received via the **Priority** object, as given in the following table:

Telegram received by the priority operation object		Status of the outputs
Bit 1	Bit 2	
0	0	End of the priority
0	1	End of the priority
1	0	Priority OFF
1	1	Priority ON

Communication objects:

- 16 - Outputs 1-2 - Priority** (2 bit - 2.002 DPT_Bool_Control)
- 56 - Outputs 3-4 - Priority** (2 bit - 2.002 DPT_Bool_Control)
- 96 - Outputs 5-6 - Priority** (2 bit - 2.002 DPT_Bool_Control)
- 136 - Outputs 7-8 - Priority** (2 bit - 2.002 DPT_Bool_Control)
- 176 - Outputs 9-10 - Priority** (2 bit - 2.002 DPT_Bool_Control)

For configuration see section: [Priority Shutter](#).

* Default value

Parameter	Description	Value
Alarm	The Alarm tab and the associated parameters and objects are: Hidden. Displayed for 1 alarm object Displayed for 2 alarm objects Displayed for 3 alarm objects	Not active* 1 alarm object 2 alarm objects 3 alarm objects

Communication objects:

- [18 - Outputs 1-2 - Alarm 1](#) (1 bit - 1.005 DPT_Alarm)
- [58 - Outputs 3-4 - Alarm 1](#) (1 bit - 1.005 DPT_Alarm)
- [98 - Outputs 5-6 - Alarm 1](#) (1 bit - 1.005 DPT_Alarm)
- [138 - Outputs 7-8 - Alarm 1](#) (1 bit - 1.005 DPT_Alarm)
- [178 - Outputs 9-10 - Alarm 1](#) (1 bit - 1.005 DPT_Alarm)

Communication objects:

- [19 - Outputs 1-2 - Alarm 2](#) (1 bit - 1.005 DPT_Alarm)
- [59 - Outputs 3-4 - Alarm 2](#) (1 bit - 1.005 DPT_Alarm)
- [99 - Outputs 5-6 - Alarm 2](#) (1 bit - 1.005 DPT_Alarm)
- [139 - Outputs 7-8 - Alarm 2](#) (1 bit - 1.005 DPT_Alarm)
- [179 - Outputs 9-10 - Alarm 2](#) (1 bit - 1.005 DPT_Alarm)

Communication objects:

- [20 - Outputs 1-2 - Alarm 3](#) (1 bit - 1.005 DPT_Alarm)
- [60 - Outputs 3-4 - Alarm 3](#) (1 bit - 1.005 DPT_Alarm)
- [100 - Outputs 5-6 - Alarm 3](#) (1 bit - 1.005 DPT_Alarm)
- [140 - Outputs 7-8 - Alarm 3](#) (1 bit - 1.005 DPT_Alarm)
- [180 - Outputs 9-10 - Alarm 3](#) (1 bit - 1.005 DPT_Alarm)

For configuration see section: [Alarm](#).

Parameter	Description	Value
Sun protection	The Reactivate sun protection tab and the associated parameters and objects are: Hidden. Displayed.	Not active* Active

Communication objects:

- [22 - Outputs 1-2 - Sun protection position %](#) (1 byte - 5.001 DPT_Scaling)
- [62 - Outputs 3-4 - Sun protection position %](#) (1 byte - 5.001 DPT_Scaling)
- [102 - Outputs 5-6 - Sun protection position %](#) (1 byte - 5.001 DPT_Scaling)
- [142 - Outputs 7-8 - Sun protection position %](#) (1 byte - 5.001 DPT_Scaling)
- [182 - Outputs 9-10 - Sun protection position %](#) (1 byte - 5.001 DPT_Scaling)

* Default value

- Communication objects:
- 23 - Outputs 1-2 - Slat angle (0-100%)** (1 byte - 5.001 DPT_Scaling)
 - 63 - Outputs 3-4 - Slat angle (0-100%)** (1 byte - 5.001 DPT_Scaling)
 - 103 - Outputs 5-6 - Slat angle (0-100%)** (1 byte - 5.001 DPT_Scaling)
 - 143 - Outputs 7-8 - Slat angle (0-100%)** (1 byte - 5.001 DPT_Scaling)
 - 183 - Outputs 9-10 - Slat angle (0-100%)** (1 byte - 5.001 DPT_Scaling)

For configuration see section: [Sun protection](#).

3.9.2 Scene

Device: 1.1.2 10-fold switch actuator 4A 230V AC

Outputs 1-10: Function	Number of scenes used	8
Outputs 1-10: Function selection	Scenes memorisation by long key press	Active
- O1-10: Manual mode ON/OFF	Scenes memorisation acknowledgment (Output status inversed for 3s)	Not active
- O1-10: Status indications ON/OFF	Position for scene 1	Not active
Outputs 1-2: Function selection	Position for scene 2	Not active
- O1-2: Scenes	Position for scene 3	Not active
Output 3: Function selection	Position for scene 4	Not active
Output 4: Function selection	Position for scene 5	Not active
Output 5: Function selection	Position for scene 6	Not active
Output 6: Function selection	Position for scene 7	Not active
Output 7: Function selection	Position for scene 8	Not active
Output 8: Function selection		
Output 9: Function selection		
Output 10: Function selection		
Information		

Parameter	Description	Value
Number of scenes used	This parameter determines the number of scenes used.	8* - 16 - 24 - 32 - 48 - 64

Note: If the Scene number received on the Scene object is greater than the maximum number of scenes, the status of the output remains unchanged.

Parameter	Description	Value
Scenes memorisation by very long key press	This parameter allows learning and storing of a scene by, for example, a long press (> 5 seconds) of the corresponding push button.	Not active Active*

* Default value

Learning and storing scenes

This process is used to change and store a scene. For example, by locally pressing the key in the room or by emission of the values from a visualization.

To access and store scenes, the following values must be sent:

Scene number	Access scene (Object value: 1 byte)	Store scene (Object value: 1 byte)
1 - 64	= Scene number - 1	= Scene number + 128
Example		
1	0	128
2	1	129
3	2	130
...	...	
64	63	191

Here is the scene memorisation for local switches, for example.

- Activate scene by briefly pressing the transmitter that starts it.
- The outputs (lights, shutters, etc.) are set in the desired state using the usual local control devices (buttons, remote control, etc.).
- Memorise the status of the outputs with a press greater than 5 seconds long on the transmitter that starts the scene. The memorisation can be displayed by short-term activation of the outputs.

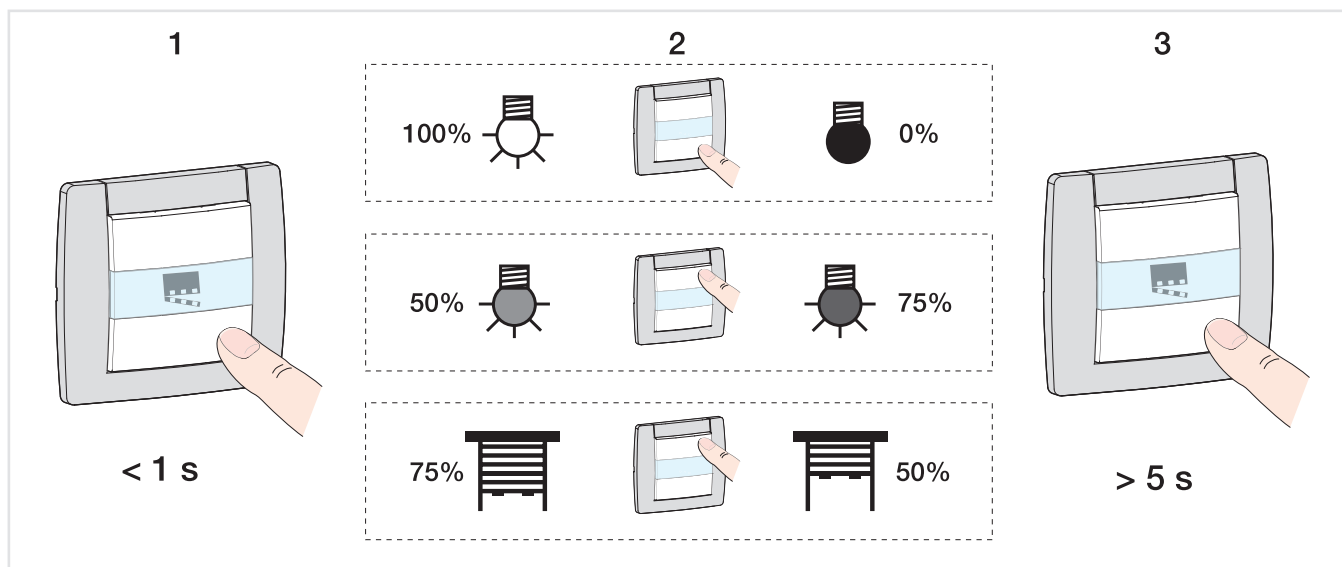

Parameter	Description	Value
Scenes memorisation acknowledgment	Memorisation of a scene is: Not acknowledged. Acknowledged by the output by a 3 second long inversion of the output status.	Not active* Active

* Default value

Parameter	Description	Value
Position for scene X	On activation of Scene X, the output is: Not changed. Closes the Up contact. Closes the down contact. Runs to a specific position. Reactivate the sun protection function. Lock-up the Sun protection function.	Not active* Up Down Specific position Sun protection reactivation Deactivation sun protection

X = 1 to 64

*Note: Each output has up to 64 scenes available, in accordance with the **Number of scenes used** parameter.*

Note: The Sun protection function of the selected output must be configured. If this is not the case, the status remains unchanged. If this is not the case, the status remains unchanged.

*Note: Local storage of the scene is not recorded if the **Position for scene X** parameter is not active.*

Parameter	Description	Value
Position (0-100%)	This parameter defines the position to run the shutter or blind to for scene X.	0 ... 5* ... 100

*Note: This parameter is only visible if the **Position for scene X** parameter has the following value: **Specific position**.*

Parameter	Description	Value
Slat angle (0-100%)	This parameter defines the slat position of the blind to be used for scene X.	0 ... 5* ... 100

*Note: This parameter is only visible if the **Position for scene X** parameter has the value **Specific position** and if the **Closing type for channel** parameter has the value **blind**.*

* Default value

3.9.3 Lock-up

Device: 1.1.2 10-fold switch actuator 4A 230V AC

Outputs 1-10: Function selection	Lock-up type	Output lock-up
Outputs 1-10: Function selection - O1-10: Manual mode ON/OFF - O1-10: Status indications ON/OFF	Lock-up duration	Permanently
Outputs 1-2: Function selection - O1-2: Lock-up	Polarity of lock-up object 1	0 = Lock-up deactivated, 1 = Lock-up activated
Output 3: Function selection	Polarity of lock-up object 2	0 = Lock-up deactivated, 1 = Lock-up activated
Output 4: Function selection	Priority between lock-up 1 and lock-up 2	Lock-up 1 > Lock-up 2
Output 5: Function selection	Position during lock-up 1	Maintain status
Output 6: Function selection	Position during lock-up 2	Maintain status
Output 7: Function selection	Position after lock-up function 1	Maintain status
Output 8: Function selection	Position after lock-up function 2	Maintain status
Output 9: Function selection	Activation of lock-up status object	Active
Output 10: Function selection	Polarity	0 = Lock-up deactivated, 1 = Lock-up activated
Information	Emission	On status change and periodically
	Hours (h)	0
	Minutes (min)	10
	Seconds (s)	0

The Lock-up function is used to lock the output in a predefined state.
 Priority: Manual mode > Priority > **Lock-up** > Basic function.
 The Lock-up prevents actuation until an unlock command has been received.
 The Lock-up duration can be set.

Parameter	Description	Value
Lock-up type	<p>The Lock-up acts: Directly on the switch actuator. As long as the Lock-up is active, the output can only be controlled by higher priority commands.</p> <p>On selected communication objects. As long as the Lock-up is active, the output can only be controlled via specific selectable objects.</p>	<p>Output lock-up*</p> <p>Object lock-up</p>

* Default value

Parameter	Description	Value
Lock-up duration	The duration of the Lock-up is Not time limited, the lock-up is only authorized by means of a telegram on Lock-up 1 object. Is active for a limited time, the control of the output is authorized after expiry of this time.	Permanently* Time limited

Parameter	Description	Value
Hours (h)	This parameter determines the activation time of the Lock-up.	0 hours: 0 to 23 h
Minutes (min)		15 minutes: 0 to 59 min
Seconds (s)		0 seconds: 0 to 59 s

Note: The smallest executable time is 1 second.

Note: This parameter is only visible if the **Lock-up duration** parameter has the following value: **Time limited**.

Parameter	Description	Value
Polarity of lock-up object 1	On receipt of a value on the Lock-up 1 object, the lock-up: Is activated on object value 1. Is deactivated on object value 0. Is activated on object value 0. Is deactivated on object value 1.	0 = Lock-up deactivated, 1 = Lock-up activated* 0 = Lock-up activated, 1 = Lock-up deactivated

Note: The parameters and objects are identical for Lock-up 2 ; Only the terms will be adjusted.

Parameter	Description	Value
Priority between lock-up 1 and lock-up 2	The priority between lock-up 1 and lock-up 2 is set as follows: Lock-up 1 has priority over lock-up 2. Lock-up 2 has priority over lock-up 1. Lock-up 1 and lock-up 2 have the same priority.	Lock-up 1 > Lock-up 2* Lock-up 1 < Lock-up 2 Lock-up 1 = Lock-up 2

Note: This parameter is only visible if the **Lock-up** parameter has the following value: **Active with 2 lock-up objects**.

Note: The priority of the Lock-up always functions in the same way, independently of the lock-up type (Output lock-up or object lock-up).

* Default value

Operating principle of the priorities:
If Lock-up 1 > Lock-up 2

Active lock-up	Activation order of Lock-up 1	Activation order of Lock-up 2
None	Lock-up 1 is activated	Lock-up 2 is activated
Lock-up 1	Lock-up 1 remains active	Despite the activation order of Lock-up 2, Lock-up 1 remains activated
Lock-up 2	Lock-up 1 is activated	Lock-up 2 remains active

If Lock-up 1 = Lock-up 2

Active lock-up	Activation order of Lock-up 1	Activation order of Lock-up 2
None	Lock-up 1 is activated	Lock-up 2 is activated
Lock-up 1	Lock-up 1 remains active	Lock-up 2 is activated
Lock-up 2	Lock-up 1 is activated	Lock-up 2 remains active

If Lock-up 1 < Lock-up 2

Active lock-up	Activation order of Lock-up 1	Activation order of Lock-up 2
None	Lock-up 1 is activated	Lock-up 2 is activated
Lock-up 1	Lock-up 1 remains active	Lock-up 2 is activated
Lock-up 2	Despite the activation order of Lock-up 1, Lock-up 2 remains activated	Lock-up 2 remains active

Parameter	Description	Value
Position during lock-up 1	During Lock-up 1, the shutter/blind output: Not changed. Closes the Up contact. Closes the down contact. Opens the 2 contacts. Runs to a specific position.	Maintain status* Up Down Stop Specific position

Note: The parameters and objects are identical for Lock-up 2 ; Only the terms will be adjusted.

Parameter	Description	Value
Position (0-100%)	This parameter defines the position to run the shutter or blind to.	0 ... 5* ... 100

Note: This parameter is only visible if the **Position during lock-up 1]** parameter has the following value: **Specific position**.

Parameter	Description	Value
Slat angle (0-100%)	This parameter defines the slat position to use for the blind.	0 ... 5* ... 100

Note: This parameter is only visible if the **Position during lock-up 1** parameter has the value **Specific position** and if the **Closing type for channel** parameter has the value **blind**.

* Default value

Lock-up 1 authorizes object:

The parameters listed below allow the selection of the objects for controlling the output via the nevertheless active Lock-up.

*Note: These parameters are only visible if the **Lock-up type** parameter has the following value: **Object lock-up**.*

Parameter	Objects concerned	Value
Up/down	Up/Down (long key-press)	Yes No*
Slat angle/stop	Step/stop (short press)	Yes No*
Scene	Scene	Yes No*
Position in %	Position in %	Yes No*
Slat angle in %	Slat angle in %	Yes No*
Sun protection position in %	Sun protection position in %	Yes No*
Sun protection slat angle in %	Slat angle (0-100%)	Yes No*
Preset 1	Preset 1	Yes No*
Preset 2	Preset 2	Yes No*

Note: The parameters and objects are identical for Lock-up 2 ; Only the terms will be adjusted.

Parameter	Description	Value
Position after lock-up function 1	After lock-up 1, the shutter/blind output: Not changed. Closes the Up contact. Closes the down contact. Runs to a specific position. Returns to the position before lock-up 1. Runs to the position which would be active according to other communication objects if lock-up 1 had not taken place.	Maintain status* Up Down Specific position Status before lock-up Theoretical status without lock-up function 1

*Note: On **Theoretical status without lock-up function 1**, the Up/Down and slat step commands are not saved.*

Note: The parameters and objects are identical for Lock-up 2 ; Only the terms will be adjusted.

Parameter	Description	Value
Position (0-100%)	This parameter defines the position to run the shutter or blind to.	0 ... 5* ... 100

*Note: This parameter is only visible if the **Position after lock-up function 1** parameter has the following value: **Specific position**.*

* Default value

Parameter	Description	Value
Slat angle (0-100%)	This parameter defines the slat position to use for the blind.	0 ... 5* ... 100

Note: This parameter is only visible if the **Position after lock-up function 1** parameter has the value **Specific position** and if the **Closing type for channel** parameter has the value **blind**.

Parameter	Description	Value
Activation of lock-up status object	The Status indication lock-up communication object is hidden.	Not active*
	The Status indication lock-up communication object is displayed.	Active

Communication objects:

- [15 - Outputs 1-2 - Status indication lock-up \(1 bit - 1.011 DPT_State\)](#)
- [55 - Outputs 3-4 - Status indication lock-up \(1 bit - 1.011 DPT_State\)](#)
- [95 - Outputs 5-6 - Status indication lock-up \(1 bit - 1.011 DPT_State\)](#)
- [135 - Outputs 7-8 - Status indication lock-up \(1 bit - 1.011 DPT_State\)](#)
- [175 - Outputs 9-10 - Status indication lock-up \(1 bit - 1.011 DPT_State\)](#)

Parameter	Description	Value
Polarity	The Status indication Lock-up communication object sends: 0 on deactivation of the lock-up. 1 on activation of the lock-up. 0 on activation of the lock-up. 1 on deactivation of the lock-up.	0 = Lock-up deactivated, 1 = Lock-up activated* 0 = Lock-up activated, 1 = Lock-up deactivated

Parameter	Description	Value
Emission	The Status indication lock-up communication object is sent: On activation and deactivation of the lock-up. Periodically after a configurable time. On activation and deactivation of the lock-up and periodically after a configurable time.	On status change* Periodically On status change and periodically

Note: This parameter is only visible if the **Activation of Lock-up status object** parameter has the following value: **Active**.

Parameter	Description	Value
Hours (h)	This parameter determines the time between the individual transmissions of the Status indication lock-up object.	0 hours: 0 to 23 h
Minutes (min)		10 minutes: 0 to 59 min
Seconds (s)		0 seconds: 0 to 59 s

Note: The smallest executable time is 1 second.

Note: This parameter is only visible if the **Emission** parameter has the following value: **Periodically** or **On status change and periodically**.

* Default value

3.9.4 Preset

Device: 1.1.2 10-fold switch actuator 4A 230V AC

Outputs 1-10: Function	Preset authorization objects	Active
Outputs 1-10: Function selection	Value of authorization preset 1 at initialization	Value before initialization
- O1-10: Manual mode ON/OFF	Value of authorization preset 2 at initialization	Value before initialization
- O1-10: Status indications ON/OFF	Polarity of Preset 1 authorization object	0 = Locked-up , 1 = Authorized
Outputs 1-2: Function selection	Polarity of Preset 2 authorization object	0 = Locked-up , 1 = Authorized
- O1-2: Preset	Position in % if preset 1 = 0	Scene number
Output 3: Function selection	Scene for preset 1 = 0	1
Output 4: Function selection	Position in % if preset 1 = 1	Specific position
Output 5: Function selection	Position (0-100%)	100
Output 6: Function selection	Slat angle (0-100%)	100
Output 7: Function selection	Position in % if preset 2 = 0	Maintain status
Output 8: Function selection	Position in % if preset 2 = 1	Maintain status
Output 9: Function selection		
Output 10: Function selection		
Information		

The Preset function is used to switch an output into various predefined states. The Preset function is activated via an object in 1-bit format.

Principle of Preset authorization:

The parameters are set as follows:

- Polarity of Preset 1 authorization object: 0 = Locked-up, 1 = Authorized.
- Polarity of Preset 2 authorization object: 0 = Locked-up, 1 = Authorized.
- Position in % if preset 1 = 0: Shutter DOWN.
- Position in % if preset 1 = 1: Shutter UP.
- Position in % if preset 2 = 0: Scene 1.
- Position in % if preset 2 = 1: Scene 2.

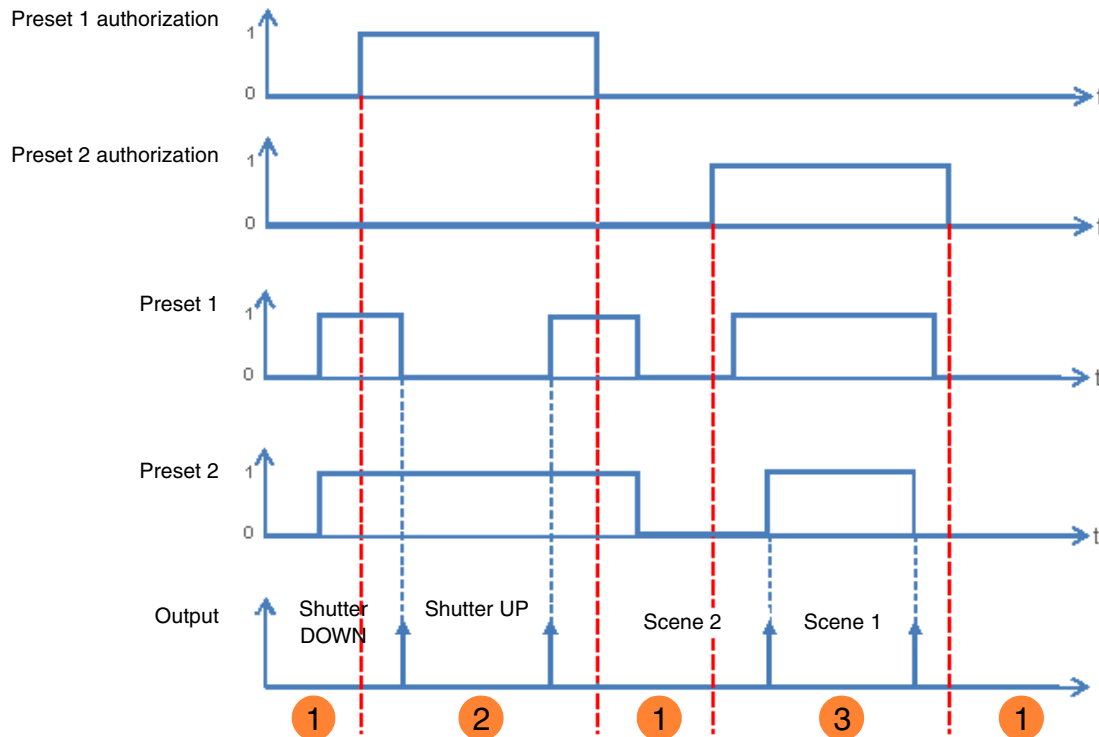

- ❶ The preset inputs have no influence on the output.
- ❷ The commands from Preset 1 are executed.
- ❸ The commands from Preset 2 are executed.

Note: The commands from the Preset will not be executed immediately after authorization, but only when the value of the Preset changes.

Parameter	Description	Value
Preset authorization objects	The Preset 1 authorization communication object and the related parameters are: Hidden. Displayed. This object allows the authorization or lock-up of the Preset 1 function via a KNX telegram.	Not active* Active

*Note: The number of available Preset objects is dependent on the **Preset** parameter. A maximum of two of these objects can be available.*

Communication objects:

- 11 - Outputs 1-2 - Preset 1 authorization** (1 bit - 1.003 DPT_Enable)
- 51 - Outputs 34 - Preset 1 authorization** (1 bit - 1.003 DPT_Enable)
- 91 - Outputs 5-6 - Preset 1 authorization** (1 bit - 1.003 DPT_Enable)
- 131 - Outputs 7-8 - Preset 1 authorization** (1 bit - 1.003 DPT_Enable)
- 171 - Outputs 9-10 - Preset 1 authorization** (1 bit - 1.003 DPT_Enable)

* Default value

- Communication objects:
- 12 - Outputs 1-2 - Preset 2 authorization** (1 bit - 1.003 DPT_Enable)
 - 52 - Outputs 3-4 - Preset 2 authorization** (1 bit - 1.003 DPT_Enable)
 - 92 - Outputs 5-6 - Preset 2 authorization** (1 bit - 1.003 DPT_Enable)
 - 132 - Outputs 7-8 - Preset 2 authorization** (1 bit - 1.003 DPT_Enable)
 - 172 - Outputs 9-10 - Preset 2 authorization** (1 bit - 1.003 DPT_Enable)

Note: The parameters and objects are identical for Preset 2 ; Only the terms will be adjusted.

Parameter	Description	Value
Value of authorization preset 1 at initialization	On initialization of the device after a download or after return of the bus power, the value of the Preset 1 authorization object is: Set to 0. Set to 1. Set according to the value of the logic input before the initialization occurred.	0 1 Value before initialization*

Note: This parameter is only visible if the **Preset authorization objects** parameter has the following value: **Active**.

Parameter	Description	Value
Polarity of Preset 1 authorization object	On receipt of a value on the Preset 1 authorization object, Preset 1 : Locked-up on object value 1. Locked-up on object value 0.	0 = Locked-up, 1 = Authorized* 0 = Authorized, 1 = Locked-up

Note: This parameter is only visible if the **Preset authorization objects** parameter has the following value: **Active**.

Parameter	Description	Value
Position in % if preset 1 = 0	During Preset 1 = 0 , the shutter/blind output: Not changed. Closes the Up contact. Closes the down contact. Opens the 2 contacts. Runs to a specific position. Runs to a position set in a scene. Reactivate the sun protection function. Lock-up the Sun protection function. Runs back to the position for Preset 1 = 1	Maintain status* Up Down Stop Specific position Scene number Activate sun protection Deactivation sun protection Status before preset 1 = 1

* Default value

Parameter	Description	Value
Position (0-100%)	This parameter defines the position to run the shutter or blind to.	0* ... 100

Note: This parameter is only visible if the **Position in % if preset 1 = 0** parameter has the following value: **Specific position**.

Parameter	Description	Value
Slat angle (0-100%)	This parameter defines the slat position to use for the blind.	0* ... 100

Note: This parameter is only visible if the **Position in % if preset 1 = 0** parameter has the value **Specific position** and if the **Closing type for channel** parameter has the value **blind**.

Parameter	Description	Value
Scene number for preset 1 = 0	This parameter determines the value of the scene if: The Preset 1 object has value 0.	Scene 1 ... 64
	The Status if preset 1 object = 0 object has the scene value.	Default value: 1

Parameter	Description	Value
Position in % if preset 1 = 1	During Preset 1 = 0 , the shutter/blind output	Maintain status* Up Down Stop Specific position Scene number Activate sun protection Deactivation sun protection Status before preset 1 = 0
	Not changed.	
	Closes the Up contact.	
	Closes the down contact.	
	Opens the 2 contacts.	
	Runs to a specific position.	
	Runs to a position set in a scene.	
	Reactivate the sun protection function.	
	Lock-up the Sun protection function.	
Runs back to the position for Preset 1 = 0		

Parameter	Description	Value
Position (0-100%)	This parameter defines the position to run the shutter or blind to.	0* ... 100

Note: This parameter is only visible if the **Position in % if preset 1 = 1** parameter has the following value: **Specific position**.

* Default value

Parameter	Description	Value
Slat angle (0-100%)	This parameter defines the slat position to use for the blind.	0* ... 100

*Note: This parameter is only visible if the **Position in % if preset 1 = 1** parameter has the value **Specific position** and if the **Closing type for channel** parameter has the value **blind**.*

Parameter	Description	Value
Scene number for preset 1 = 1	This parameter determines the value of the scene if: The Preset 1 object has value 1. The Status if preset 1 object = 1 object has the scene value.	Scene 1 ... 64 Default value: 2

* Default value

3.9.5 Priority

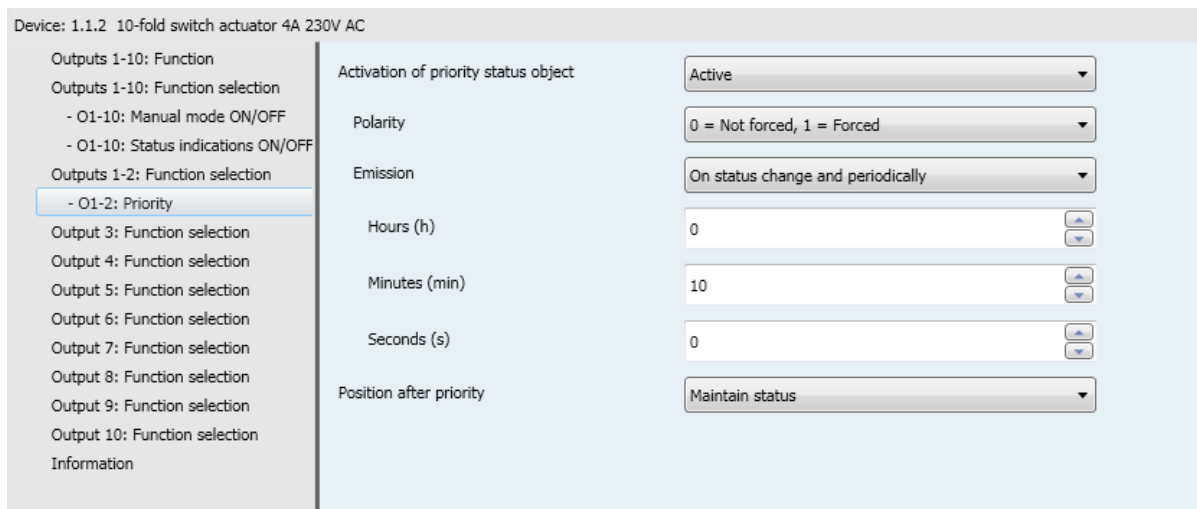

The Priority is used to force the output into a predefined state.

Priority: Manual mode > **Priority** > Lock-up > Basic function.

No other command is taken into account when the Priority is active. Only by ending the Priority are other commands again permitted.

Parameter	Description	Value
Activation of priority status object	The Status indication priority communication object and related parameters are hidden.	Not active*
	The Status indication priority communication object and related parameters are displayed.	Active

- Communication objects:
- [17 - Outputs 1-2 - Status indication priority \(1 bit - 1.011 DPT_State\)](#)
 - [57 - Outputs 3-4 - Status indication priority \(1 bit - 1.011 DPT_State\)](#)
 - [97 - Outputs 5-6 - Status indication priority \(1 bit - 1.011 DPT_State\)](#)
 - [137 - Outputs 7-8 - Status indication priority \(1 bit - 1.011 DPT_State\)](#)
 - [177 - Outputs 9-10 - Status indication priority \(1 bit - 1.011 DPT_State\)](#)

Parameter	Description	Value
Polarity	The Status indication priority communication object sends: 0 on deactivation of the Priority. 1 on activation of the Priority. 0 on activation of the Priority. 1 on deactivation of the Priority.	0 = Not forced, 1 = Forced* 0 = Forced, 1 = Not forced

*Note: This parameter is only visible if the **Activation of priority status object** parameter has the following value: **Active**.*

* Default value

Parameter	Description	Value
Emission	The Status indication priority communication object is sent: On activation and deactivation of the Priority. Periodically after a configurable time. On activation and deactivation of the Priority and periodically after a configurable time.	On status change* Periodically On status change and periodically

Note: This parameter is only visible if the **Activation of priority status object** parameter has the following value: **Active**.

Parameter	Description	Value
Hours (h)	This parameter determines the time between the individual transmissions of the Status indication priority object.	0 hours: 0 to 23 h
Minutes (min)		10 minutes: 0 to 59 min
Seconds (s)		0 seconds: 0 to 59 s

Note: The smallest executable time is 1 second.

Note: This parameter is only visible if the **Emission** parameter has the following value: **Periodically** or **On status change and periodically**.

Parameter	Description	Value
Position after priority	After Priority, the shutter/blind output: Not changed. Closes the Up contact. Closes the down contact. Runs to a specific position. Returns to the Position before priority. Runs to the position which would be active according to other communication objects if the priority had not taken place.	Maintain status* Up Down Specific position Status before priority Theoretical status without priority

Parameter	Description	Value
Position (0-100%)	This parameter defines the position to run the shutter or blind to on disappearing of the priority.	0 ... 5* ... 100

Note: This parameter is only visible if the **Position after priority** parameter has the following value: **Specific position**.

Parameter	Description	Value
Slat angle (0-100%)	This parameter defines the slat position to apply to the blind on disappearing of the priority.	0 ... 5* ... 100

Note: This parameter is only visible if the **Position after priority** parameter has the value **Specific position** and if the **Closing type** for channel parameter has the value **blind**.

* Default value

3.9.6 Alarm

Device: 1.1.2 10-fold switch actuator 4A 230V AC

Outputs 1-10: Function selection

Outputs 1-10: Function selection

- O1-10: Manual mode ON/OFF
- O1-10: Status indications ON/OFF

Outputs 1-2: Function selection

- O1-2: Alarm

Output 3: Function selection

Output 4: Function selection

Output 5: Function selection

Output 6: Function selection

Output 7: Function selection

Output 8: Function selection

Output 9: Function selection

Output 10: Function selection

Information

Alarm 1 Permanently

Position on alarm 1 Maintain status

Position after alarm 1 Maintain status

Alarm 2 Permanently

Position on alarm 2 Maintain status

Position after alarm 2 Maintain status

Alarm 3 Permanently

Position on alarm 3 Maintain status

Position after alarm 3 Maintain status

Priority between alarm 1, 2 and 3 Alarm 1 > Alarm 2 > Alarm 3

Alarm status object Active

Polarity 0 = Alarm deactivated, 1 = Alarm activated

Emission On status change

Alarm monitoring period Active

Hours (h) 0

Minutes (min) 30

Seconds (s) 0

3.9.6.1 Alarm 1 to 3

Parameter	Description	Value
Alarm X	This parameter defines whether the Alarm function is active permanently or time-limited.	Permanently* Time limited

Permanently: The function is active until receipt of an alarm cancellation.

Time limited: The function is activated for a given period. At the end of this delay, the alarm is no longer active. To switch the Alarm function on again for a given period, a new activation of the function is required.

Parameter	Description	Value
Hours (h)	This parameter determines the activation time of the Alarm function.	0 hours: 0 to 23 h
Minutes (min)		30 minutes: 0 to 59 min
Seconds (s)		0 seconds: 0 to 59 s

Note: The smallest executable time is 1 second.

*Note: This parameter is only visible if the **Alarm X** parameter has the following value: **Time limited**.*

* Default value

Parameter	Description	Value
Position on alarm X	On Alarm X, the shutter/blind output: Not changed. Closes the Up contact. Closes the down contact. Opens the 2 contacts. Runs to a specific position. Runs to a position set in a scene.	Maintain status* Up Down Stop Specific position Scene number

X = 1 to 3

Parameter	Description	Value
Position (0-100%)	This parameter defines the position to run the shutter or blind to on triggering of the relevant alarms.	0 ... 5* ... 100

Note: This parameter is only visible if the **Position on alarm X** parameter has the following value: **Specific position**.

Parameter	Description	Value
Slat angle (0-100%)	This parameter defines the slat position to apply to the blind on triggering of the relevant alarm.	0 ... 5* ... 100

Note: This parameter is only visible if the **Position on alarm X** parameter has the value **Specific position** and if the **Closing type** for channel parameter has the value **blind**.

Parameter	Description	Value
Scene	This parameter defines the scene number to be activated on triggering of the relevant alarm.	Scene 1 ... 64 Default value: 1

X = 1 to 3

The outputs respond according to the scene numbers and associated parameters.

Note: This parameter is only visible if the **Position on alarm X** parameter has the following value: **Scene**.

Parameter	Description	Value
Position after alarm X	After Alarm X, the shutter/blind output: Not changed. Closes the Up contact. Closes the down contact. Opens the 2 contacts. Runs to a specific position. Runs to a position set in a scene. Returns to the Position before alarm. Runs to the position which would be active according to other communication objects if the alarm had not taken place.	Maintain status* Up Down Stop Specific position Scene number Position before alarm Theoretical status without alarm X

X = 1 to 3

* Default value

Parameter	Description	Value
Position (0-100%)	This parameter defines the position to run the shutter or blind to on disappearing of the relevant alarms.	0 ... 5* ... 100

Note: This parameter is only visible if the **Position after alarm X** parameter has the following value: **Specific position**.

Parameter	Description	Value
Slat angle (0-100%)	This parameter defines the slat position to apply to the blind on disappearing of the relevant alarm.	0 ... 5* ... 100

Note: This parameter is only visible if the **Position after alarm X** parameter has the value **Specific position** and if the **Closing type** for channel parameter has the value **blind**.

Parameter	Description	Value
Scene	This parameter defines the scene number to be activated on disappearing of the relevant alarm.	Scene 1 ... 64 Default value: 1

X = 1 to 3

The outputs respond according to the scene numbers and associated parameters.

Note: This parameter is only visible if the **Position after alarm X** parameter has the following value: **Scene**.

If several alarms triggered at the same time, the commands associated with the highest priority alarm are executed. The following parameters allow definition of this priority according to the alarm number.

Parameter	Description	Value
Priority between alarm 1 and 2	This parameter defines the priority between 2 alarm functions.	Alarm 1 > Alarm 2* Alarm 2 > Alarm 1

Note: This parameter is only visible if the **Alarm** parameter has the following value: **2 alarm objects**.

Parameter	Description	Value
Priority between alarm 1, 2 and 3	This parameter defines the priority between 3 alarm functions.	Alarm 1 > Alarm 2 > Alarm 3* Alarm 1 > Alarm 3 > Alarm 2 Alarm 2 > Alarm 1 > Alarm 3 Alarm 2 > Alarm 3 > Alarm 1 Alarm 3 > Alarm 1 > Alarm 2 Alarm 3 > Alarm 2 > Alarm 1

Note: This parameter is only visible if the **Alarm** parameter has the following value: **3 alarm objects**.

* Default value

3.9.6.2 Alarm status indication

Parameter	Description	Value
Alarm status object	This parameter is used to authorize the Alarm status object. This object allows the status of the alarm to be sent from the device over the KNX bus.	Not active* Active

Communication objects:

21 - Outputs 1-2 - Alarm status indication (1 bit - 1.011 DPT_State)

61 - Outputs 3-4 - Alarm status indication (1 bit - 1.011 DPT_State)

101 - Outputs 5-6 - Alarm status indication (1 bit - 1.011 DPT_State)

141 - Outputs 7-8 - Alarm status indication (1 bit - 1.011 DPT_State)

181 - Outputs 9-10 - Alarm status indication (1 bit - 1.011 DPT_State)

Parameter	Description	Value
Polarity	The Alarm status object sends: 0 if no alarm is active. 1 if one of the three alarms is active. 1 if no alarm is active. 0 if one of the three alarms is active.	0 = Alarm deactivated, 1 = Alarm activated* 0 = Alarm activated, 1 = Alarm deactivated

Parameter	Description	Value
Emission	The Alarm status indication communication object is sent: On activation and deactivation of the alarm. Periodically after a configurable time. On activation and deactivation of the alarm and periodically after a configurable time.	On status change* Periodically On status change and periodically

Note: This parameter is only visible if the **Alarm status object** parameter has the following value: **Active**.

Parameter	Description	Value
Hours (h)	This parameter determines the time between the individual transmissions of the Status indication lock-up object.	0 hours: 0 to 23 h
Minutes (min)		30 minutes: 0 to 59 min
Seconds (s)		0 seconds: 0 to 59 s

Note: The smallest executable time is 1 second.

Note: This parameter is only visible if the **Emission** parameter has the following value: **Periodically** or **On status change and periodically**.

* Default value

3.9.6.3 Alarm monitoring period

Parameter	Description	Value
Alarm monitoring period	<p>The Alarm 1-3 objects</p> <p>Expect no periodic signal.</p> <p>Expect a periodic 0 signal.</p> <p>If this signal remains off, the super alarm is automatically activated the shutters/blinds are run to the position set by the Position on Alarm X parameter.</p>	<p>Not active*</p> <p>Active</p>

Parameter	Description	Value
Hours (h)	This parameter defines the maximum time between 2 signals on the Super alarm communication object.	0 hours: 0 to 23 h
Minutes (min)		15 minutes: 0 to 59 min
Seconds (s)		0 seconds: 0 to 59 s

Note: The smallest executable time is 1 second.

*Note: This parameter is only visible if the **Alarm monitoring period** parameter has the following value: **Active**.*

* Default value

3.9.7 Sun protection

Device: 1.1.2 10-fold switch actuator 4A 230V AC

Outputs 1-10: Function selection	Sun protection type	Objects position and slat angle
Outputs 1-10: Function selection	Sun protection lock-up by local control	Active
- O1-10: Manual mode ON/OFF	Lock-up on	Up/down and step/stop control
- O1-10: Status indications ON/OFF	Sun protection lock-up	Permanently
Outputs 1-2: Function selection	Sun protection authorization object	Active
- O1-2: Sun protection	Polarity	0 = Locked-up , 1 = Authorized
Output 3: Function selection	Value at initialization	0
Output 4: Function selection	Position after sun protection	Maintain status
Output 5: Function selection	Sun protection status object	Active
Output 6: Function selection	Polarity	0 = Locked-up , 1 = Authorized
Output 7: Function selection	Emission	On status change
Output 8: Function selection		
Output 9: Function selection		
Output 10: Function selection		
Information		

General description of the sun protection controls:

Shade trim and slat adjustments

Using the shade trim control the Sun protection is not run all the way down but rather just so far down that only a configurable strip of sunshine (e.g. 50 cm) enters the room (e.g. 50 cm). In this way, users at the bottom of the window can see out and plants on the windowsill will receive sunshine.

Note: The shade trim adjustment is only usable with sun protection that runs from the top to the bottom (Such as shutters, textile sun protection or blinds with horizontal slats). This function is not usable for a sun protection that is pulled from one side to the other or pulled in front of a window from both sides.

During slat adjustment, the horizontal slats of the blinds are not fully closed; rather they are matched to the sun condition and set automatically in such a way that the sun cannot shine directly into the room.

However diffuse daylight can enter the room between the slats and so provide glare-free room lighting. Slat adjustment of an external blind prevents the entry of heat from sunshine into the room and, at the same time, reduces the cost of electricity for room lighting.

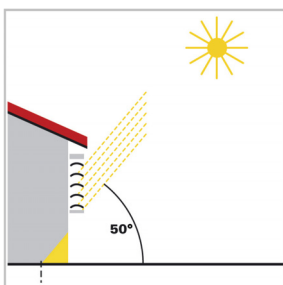

Sun protection at high sun elevations

The sun protection is only partially closed and automatically driven so far down that the sun can only shine into the room as far as the maximum permitted penetration depth. The slats can be made almost horizontal without the sun shining directly into the room.

Sun protection at medium sun elevations

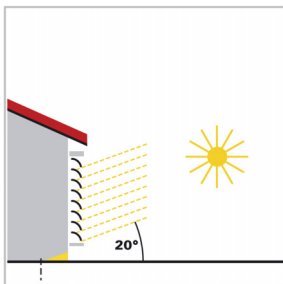

The sun protection will automatically be lowered so that the maximum penetration depth of sunshine into the room is not exceeded. The slats are automatically closed so far that the sun cannot shine directly into the room. Diffuse daylight, however, can still continue to enter and so provide lighting for the room (daylight use).

Sun protection at low sun elevations

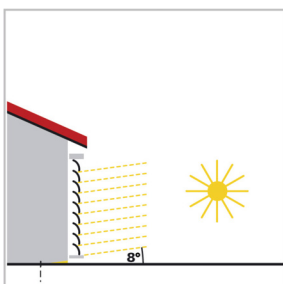

The sun protection is automatically lowered almost completely, so that the sun cannot shine too far into the room. The slats are automatically closed to an extent where the sun cannot shine directly into the room.

Parameter	Description	Value
Sun protection type	An external sun protection control sends the following commands for the positioning of the blinds: Positioning and slat adjustments. Positioning only. Slat adjustment only.	Objects position and slat angle* Position object only Slat angle object only

*Note: These objects are only visible if the **Sun protection type** parameter has the following value: **Objects position and slat angle** or **Position object only**.*

- Communication objects:
- [22 - Outputs 1-2 - Sun protection position % \(1 byte - 5.001 DPT_Scaling\)](#)
 - [62 - Outputs 3-4 - Sun protection position % \(1 byte - 5.001 DPT_Scaling\)](#)
 - [102 - Outputs 5-6 - Sun protection position % \(1 byte - 5.001 DPT_Scaling\)](#)
 - [142 - Outputs 7-8 - Sun protection position % \(1 byte - 5.001 DPT_Scaling\)](#)
 - [182 - Outputs 9-10 - Sun protection position % \(1 byte - 5.001 DPT_Scaling\)](#)

*Note: These objects are only visible if the **Sun protection type** parameter has the following value: **Objects position and slat angle** or **Slat angle object only**.*

- Communication objects:
- [23 - Outputs 1-2 - Pos. lamelles poursuite sol. % \(1 byte - 5.001 DPT_Scaling\)](#)
 - [63 - Outputs 3-4 - Pos. lamelles poursuite sol. % \(1 byte - 5.001 DPT_Scaling\)](#)
 - [103 - Outputs 5-6 - Pos. lamelles poursuite sol. % \(1 byte - 5.001 DPT_Scaling\)](#)
 - [143 - Outputs 7-8 - Pos. lamelles poursuite sol. % \(1 byte - 5.001 DPT_Scaling\)](#)
 - [183 - Outputs 9-10 - Pos. lamelles poursuite sol. % \(1 byte - 5.001 DPT_Scaling\)](#)

* Default value

Parameter	Description	Value
Sun protection lock-up by local control	<p>This parameter allows lock-up of the Sun protection position in % object and the sun protection slat position in % after operation of the shutter/blind with local KNX controls.</p> <p>When this function is activated, the Sun protection reactivation object is also displayed. This allows a reactivation of both sun protection objects.</p>	<p>Not active*</p> <p>Active</p>

Communication objects:

- [25 - Outputs 1-2 - Sun protection reactivation \(1 bit - 1.003 DPT_Enable\)](#)
- [65 - Outputs 3-4 - Sun protection reactivation \(1 bit- 1.003 DPT_Enable\)](#)
- [105 - Outputs 5-6 - Sun protection reactivation \(1 bit - 1.003 DPT_Enable\)](#)
- [145 - Outputs 7-8 - Sun protection reactivation \(1 bit - 1.003 DPT_Enable\)](#)
- [185 - Outputs 9-10 - Sun protection reactivation \(1 bit - 1.003 DPT_Enable\)](#)

Parameter	Description	Value
Lock-up on	<p>This parameter specifies on which local control commands the sun protection will lock up:</p> <p>Only after Up/Down (long key-press) commands.</p> <p>Only after slat step (short key-press) commands.</p> <p>After Up/Down and slat step command.</p> <p>After all basic commands.</p>	<p>Up/down control</p> <p>Step/stop control</p> <p>Up/down and step/stop control*</p> <p>All basic controls</p>

*Note: This parameter is only visible if the **Deactivate sun protection by local control** parameter has the following value: **Active**.*

Note: All basic commands means the commands with the lowest priority (Scenes, Preset, etc...)

Parameter	Description	Value
Sun protection lock-up	<p>This parameter defines whether the Sun protection function is permanently activated or time-limited.</p> <p>The lock-up is active until it receives a 0 or 1 signal on the Sun protection reactivation object.</p> <p>The lock-up is active for a configurable time. After expiry of which the sun protection objects are again processed.</p>	<p>Permanently*</p> <p>Time limited</p>

Parameter	Description	Value
Sun protection authorization object	<p>With this parameter, the device's Sun protection authorization object can be activated or deactivated.</p>	<p>Not active*</p> <p>Active</p>

* Default value

- Communication objects:
- 24 - Outputs 1-2 - Sun protection authorization (1 bit - 1.003 DPT_Enable)**
 - 64 - Outputs 3-4 - Sun protection authorization (1 bit- 1.003 DPT_Enable)**
 - 104 - Outputs 5-6 - Sun protection authorization (1 bit - 1.003 DPT_Enable)**
 - 144 - Outputs 7-8 - Sun protection authorization (1 bit - 1.003 DPT_Enable)**
 - 184 - Outputs 9-10 - Sun protection authorization (1 bit - 1.003 DPT_Enable)**

Principle of the Sun protection authorization function

The parameters are set as follows:
 Sun protection authorization: 0 = Locked-up, 1 = Authorized

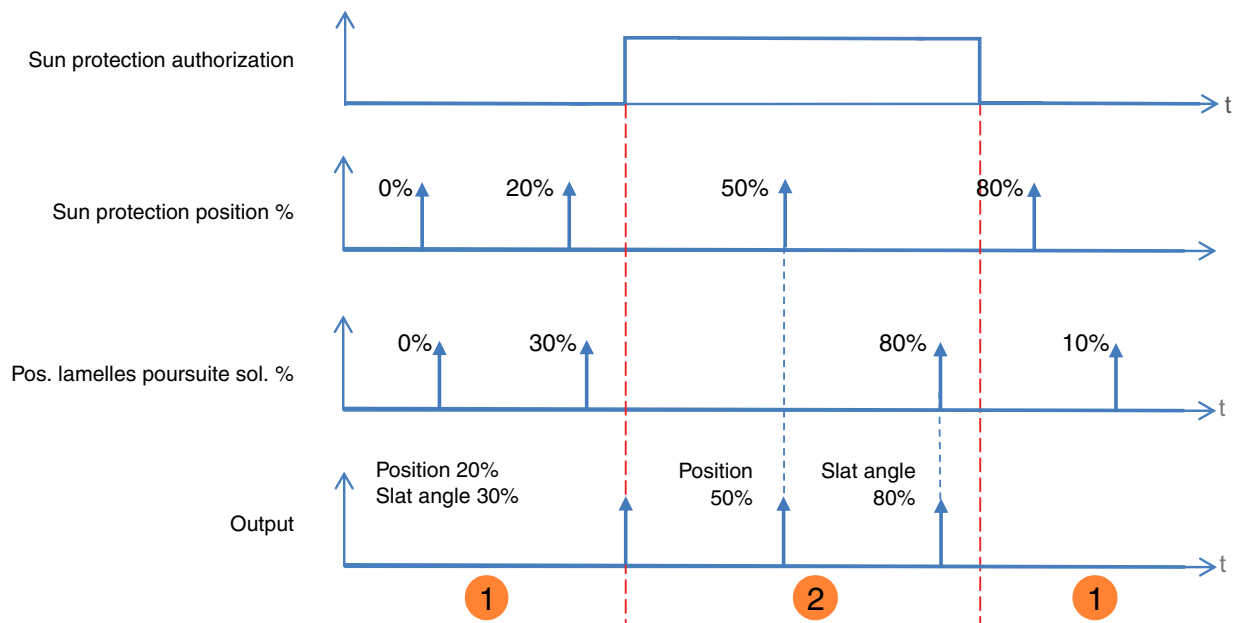

- 1** The Sun protection function has no effect on the output.
- 2** The commands from the sun protection functions are executed.

Note: The sun protection function commands will be executed immediately on authorization.

Parameter	Description	Value
Polarity	<p>This parameter defines how the device reacts on receipt of a telegram to the Sun protection authorization object:</p> <p>0 = Sun protection locked-up (OFF) 1 = Sun protection authorized (ON)</p> <p>0 = Sun protection authorized (ON) 1 = Sun protection locked-up (OFF)</p>	<p>0 = Locked-up, 1 = Authorized*</p> <p>0 = Authorized, 1 = Locked-up</p>

Note: This parameter is only visible if the **Sun protection authorization object** parameter has the following value: **Active**.

Parameter	Description	Value
Value at initialization	<p>On initialization of the device after a download or after return of the bus power, the value of the Sun protection authorization object is:</p> <p>Set to 0.</p> <p>Set to 1.</p> <p>Set according to the value that the object had before initialization.</p>	<p>0*</p> <p>1</p> <p>Value before initialization</p>

Parameter	Description	Value
Position after sun protection	<p>After lock-up of the sun protection due to a 0 on the Sun protection authorization object, the output is:</p> <p>Not changed.</p> <p>Closes the Up contact.</p> <p>Closes the down contact.</p> <p>Runs to a specific position.</p> <p>Runs to a position set in a scene.</p> <p>Run to the position before the priority.</p>	<p>Maintain status*</p> <p>Up</p> <p>Down</p> <p>Specific position</p> <p>Scene number</p> <p>Position before sun protection</p>

Parameter	Description	Value
Position (0-100%)	This parameter defines the position to run the shutter or blind to.	0* ... 100

Note: This parameter is only visible if the **Position after sun protection** has the value **Specific position** and if the **Sun protection type** parameter has the value **Position and Slat position object** or **only position object**.

Parameter	Description	Value
Slat angle (0-100%)	This parameter defines the slat position to use for the blind.	0* ... 100

Note: This parameter is only visible if the **Position after sun protection** has the value **Specific position** and if the **Sun protection type** parameter has the value **Position and Slat position object** or **Position only object**.

* Default value

Parameter	Description	Value
Scene	This parameter defines the scene number that is to be activated after the sun protection.	Scene 1 ... 64 Default value: 1

The outputs respond according to the scene numbers and associated parameters.

*Note: This parameter is only visible if the **Position after sun protection** parameter has the following value: **Scene**.*

Parameter	Description	Value
Sun protection status object.	This parameter is used to authorize the Sun protection status object. This object allows the status of the sun protection to be sent from the device to the KNX bus.	Not active* Active

Communication objects:

[26 - Outputs 1-2 - Sun protection status \(1 bit - 1.011 DPT_State\)](#)

[66 - Outputs 3-4 - Sun protection status \(1 bit - 1.011 DPT_State\)](#)

[106 - Outputs 5-6 - Sun protection status \(1 bit - 1.011 DPT_State\)](#)

[146 - Outputs 7-8 - Sun protection status \(1 bit - 1.011 DPT_State\)](#)

[186 - Outputs 9-10 - Sun protection status \(1 bit - 1.011 DPT_State\)](#)

Parameter	Description	Value
Polarity	This parameter defines the polarity of the Sun protection status : 0 = Sun protection locked-up 1 = Sun protection authorized 0 = Sun protection authorized 1 = Sun protection locked-up	0 = Locked-up, 1 = Authorized* 0 = Authorized, 1 = Locked-up

*Note: This parameter is only visible if the **Sun protection status object** parameter has the following value: **Active**.*

Parameter	Description	Value
Emission	The Sun protection status communication object is sent: On activation and deactivation of the lock-up. Periodically after a configurable time. On activation and deactivation of the lock-up and periodically after a configurable time.	On status change* Periodically On status change and periodically

*Note: This parameter is only visible if the **Sun protection status object** parameter has the following value: **Active**.*

Parameter	Description	Value
Hours (h)	This parameter determines the time between the individual transmissions of the Sun protection status objects.	0 hours: 0 to 23 h
Minutes (min)		30 minutes: 0 to 59 min
Seconds (s)		0 seconds: 0 to 59 s

Note: The smallest executable time is 1 second.

*Note: This parameter is only visible if the **Emission** parameter has the following value: **Periodically** or **On status change and periodically**.*

* Default value

4. Communication objects

4.1 Communication objects General

	Number	Name	Function of the object	Length	C	R	W	T
	200	Outputs 1-10: ON/OFF	Deactivation of manual mode	1 bit	C	R	W	-
	201	Outputs 1-10: ON/OFF	Status indication manual mode	1 bit	C	R	-	T
	202	Logic block 1	Authorization	1 bit	C	R	W	-
	203	Logic block 1	Input 1	1 bit	C	R	W	-
	204	Logic block 1	Input 2	1 bit	C	R	W	-
	205	Logic block 1	Input 3	1 bit	C	R	W	-
	206	Logic block 1	Input 4	1 bit	C	R	W	-
	207	Logic block 1	Logic result	1 bit	C	R	-	T
	208	Logic block 2	Authorization	1 bit	C	R	W	-
	209	Logic block 2	Input 1	1 bit	C	R	W	-
	210	Logic block 2	Input 2	1 bit	C	R	W	-
	211	Logic block 2	Input 3	1 bit	C	R	W	-
	212	Logic block 2	Input 4	1 bit	C	R	W	-
	213	Logic block 2	Logic result	1 bit	C	R	-	T
	214	Outputs 1-10: Shutter	Super alarm	1 bit	C	R	W	-
	215	Outputs 1-10: Shutter	Super alarm status	1 bit	C	R	-	T
	216	Outputs 1-10: Shutter	Deactivation of manual mode	1 bit	C	R	W	-
	217	Outputs 1-10: Shutter	Status indication manual mode	1 bit	C	R	-	T
	218	Logic block 1	Authorization	1 bit	C	R	W	-
	219	Logic block 1	Input 1	1 bit	C	R	W	-
	220	Logic block 1	Input 2	1 bit	C	R	W	-
	221	Logic block 1	Input 3	1 bit	C	R	W	-
	222	Logic block 1	Input 4	1 bit	C	R	W	-
	223	Logic block 1	Logic result	1 bit	C	R	-	T
	224	Logic block 2	Authorization	1 bit	C	R	W	-
	225	Logic block 2	Input 1	1 bit	C	R	W	-
	226	Logic block 2	Input 2	1 bit	C	R	W	-
	227	Logic block 2	Input 3	1 bit	C	R	W	-
	228	Logic block 2	Input 4	1 bit	C	R	W	-
	229	Logic block 2	Logic result	1 bit	C	R	-	T
	230	Outputs 1-10: ON/OFF	Restore ETS-params settings	1 bit	C	R	W	-
	231	Outputs 1-10: ON/OFF	Device LED switch off	1 bit	C	R	W	-
	232	Outputs 1-10	Diagnosis	6 byte	C	R	-	T

4.1.1 Manual mode

No.	Name	Function of the object	Data type	Flags
200	Outputs 1-10: ON/OFF	Deactivation of manual mode	1 bit - 1.001 DPT_Switch	C, R, W

This object is activated if the **Manual mode** parameter and the **Deactivation of manual mode** object are active.
 This object is used to control the manual mode via the KNX bus.
 Object value: Depends on the **Polarity** parameter.
0 = Manual mode locked-up, 1 = Manual mode authorized:

- If the object receives the value 1, manual mode is activated.
- If the object receives the value 0, manual mode is deactivated.

0 = Manual mode authorized, 1 = Manual mode locked-up:

- If the object receives the value 1, manual mode is deactivated.
- If the object receives the value 0, manual mode is activated.

For further information, see: [Manual mode: ON/OFF](#).

No.	Name	Function of the object	Data type	Flags
216	Outputs 1-10: Shutter	Deactivation of manual mode	1 bit - 1.001 DPT_Switch	C, R, W

See object No. 200

For further information, see: [Manual mode: Shutter](#).

No.	Name	Function of the object	Data type	Flags
201	Outputs 1-10: ON/OFF	Status indication manual mode	1 bit - 1.011 DPT_Switch	C, R, T

This object is activated if the **Manual mode** parameter and the **Deactivation of manual mode** object are active.
 This object is used to send the manual mode status of the device via the KNX bus.
 Object value: Depends on the **Polarity** parameter.
0 = Manual mode activated, 1 = Manual mode deactivated:

- If manual mode is deactivated, a telegram is sent with logic value 1.
- If manual mode is activated, a telegram is sent with logic value 0.

0 = Manual mode deactivated, 1 = Manual mode activated:

- If manual mode is activated, a telegram is sent with logic value 1.
- If manual mode is deactivated, a telegram is sent with logic value 0.

This object is sent periodically and/or on status change.
 For further information, see: [Manual mode: ON/OFF](#).

No.	Name	Function of the object	Data type	Flags
217	Outputs 1-10: Shutter	Status indication manual mode	1 bit - 1.011 DPT_Switch	C, R, T

See object No. 201

For further information, see: [Manual mode: Shutter](#).

4.1.2 Logic block

No.	Name	Function of the object	Data type	Flags
202	Logic block 1	Authorization	1 bit - 1.003 DPT_Enable	C, R, W
<p>This object is activated if the Logic block 1 parameter and the Lock-up logic block object are active. This object makes it possible to activate or deactivate the logic blocks of the device via the KNX bus. Object value: Depends on the Polarity parameter.</p> <p>0 = Locked-up, 1 = Authorized:</p> <ul style="list-style-type: none"> - If the object receives the value 0, logic block 1 is deactivated. - If the object receives the value 1, logic block 1 is activated. <p>0 = Authorized, 1 = Locked-up:</p> <ul style="list-style-type: none"> - If the object receives the value 0, logic block 1 is activated. - If the object receives the value 1, logic block 1 is deactivated. <p>The value of this object can be initialized at start-up of the device.</p> <p>For further information, see: Logic block : ON/OFF.</p>				

No.	Name	Function of the object	Data type	Flags
218	Logic block 1	Authorization	1 bit - 1.003 DPT_Enable	C, R, W
<p>See object No. 202</p> <p>For further information, see: Logic block : Shutter.</p>				

No.	Name	Function of the object	Data type	Flags
203	Logic block 1	Input 1	1 bit - 1.002 DPT_Bool	C, R, W
204	Logic block 1	Input 2	1 bit - 1.002 DPT_Bool	C, R, W
205	Logic block 1	Input 3	1 bit - 1.002 DPT_Bool	C, R, W
206	Logic block 1	Input 4	1 bit - 1.002 DPT_Bool	C, R, W
<p>These objects are activated in accordance with the value of the Number of logic inputs parameter. There may be up to a maximum of 4 of these objects. These objects are used to produce the status of a logic input for processing of the logic operation. The value of these objects can be initialized at start-up of the device.</p> <p>For further information, see: Logic block : ON/OFF.</p>				

No.	Name	Function of the object	Data type	Flags
219	Logic block 1	Input 1	1 bit - 1.002 DPT_Bool	C, R, W
220	Logic block 1	Input 2	1 bit - 1.002 DPT_Bool	C, R, W
221	Logic block 1	Input 3	1 bit - 1.002 DPT_Bool	C, R, W
222	Logic block 1	Input 4	1 bit - 1.002 DPT_Bool	C, R, W
<p>See object No. 203</p> <p>For further information, see: Logic block : Shutter.</p>				

No.	Name	Function of the object	Data type	Flags
207	Logic block 1	Logic result	1 bit - 1.002 DPT_Bool	C, R, T
<p>This object is activated when the Logic block 1 parameter is active. This object enables output of the results of the logic operation via the bus. The value of the object is the result of a logic AND or OR operation, according to the status of the logic inputs. There may be up to a maximum of 4 of these objects. This result can also be directly assigned to the status of the output contact.</p> <p>For further information, see: Logic block : ON/OFF.</p>				

No.	Name	Function of the object	Data type	Flags
223	Logic block 1	Logic result	1 bit - 1.002 DPT_Bool	C, R, T
<p>See object No. 207</p> <p>For further information, see: Logic block : Shutter.</p>				

No.	Name	Function of the object	Data type	Flags
208	Logic block 2	Authorization	1 bit - 1.003 DPT_Enable	C, R, W
<p>See object No. 202</p>				

No.	Name	Function of the object	Data type	Flags
224	Logic block 2	Authorization	1 bit - 1.003 DPT_Enable	C, R, W
<p>See object No. 218</p>				

No.	Name	Function of the object	Data type	Flags
209	Logic block 2	Input 1	1 bit - 1.002 DPT_Bool	C, R, W
210	Logic block 2	Input 2	1 bit - 1.002 DPT_Bool	C, R, W
211	Logic block 2	Input 3	1 bit - 1.002 DPT_Bool	C, R, W
212	Logic block 2	Input 4	1 bit - 1.002 DPT_Bool	C, R, W
<p>See object No. 203</p>				

No.	Name	Function of the object	Data type	Flags
225	Logic block 2	Input 1	1 bit - 1.002 DPT_Bool	C, R, W
226	Logic block 2	Input 2	1 bit - 1.002 DPT_Bool	C, R, W
227	Logic block 2	Input 3	1 bit - 1.002 DPT_Bool	C, R, W
228	Logic block 2	Input 4	1 bit - 1.002 DPT_Bool	C, R, W
<p>See object No. 219</p>				

No.	Name	Function of the object	Data type	Flags
213	Logic block 2	Logic result	1 bit - 1.002 DPT_Bool	C, R, T
<p>See object No. 207</p>				

No.	Name	Function of the object	Data type	Flags
229	Logic block 2	Logic result	1 bit - 1.002 DPT_Bool	C, R, T
<p>See object No. 223</p>				

4.1.3 Super alarm

No.	Name	Function of the object	Data type	Flags
214	Outputs 1-10: Shutter	Super alarm	1 bit - 1.005 DPT_Alarm	C, R, W

This object is activated when the **Super alarm** parameter is active.
 This function is used to set all the outputs of the device into a configurable blocked state.
 If the object receives the value 1, all the outputs of the device are switched to a predefined status. All other functions, including manual mode, will be locked.
 The function can only be ended by receipt of a telegram with the value 0.
 For further information, see: [Super alarm](#).

No.	Name	Function of the object	Data type	Flags
215	Outputs 1-10: Shutter	Super alarm status	1 bit - 1.005 DPT_Alarm	C, R, T

This object is activated when the **Status indication super alarm** parameter is active.
 This object allows the status of the super alarm to be sent over the KNX bus.
 Object value: Depends on the **Polarity** parameter.

0 = activated, 1 = deactivated

- If the super alarm is deactivated, a telegram with logic value 1 is sent on the KNX bus.
- If the super alarm is activated, a telegram with logic value 0 is sent on the KNX bus.

0 = deactivated, 1 = activated

- If the super alarm is activated, a telegram with logic value 1 is sent on the KNX bus.
- If the super alarm is deactivated, a telegram with logic value 0 is sent on the KNX bus.

This object is sent periodically and/or on status change.
 For further information, see: [Super alarm](#).

4.1.4 Behaviour of the device

No.	Name	Function of the object	Data type	Flags
230	Outputs 1-10	Restore ETS-params settings	1 bit - 1.015 DPT_Reset	C, R, W

This object is activated if the **Activ. of restore ETS-parameters object (scenes, timer, setpoints)** parameter is active.
 This object enables the current parameter value to be replaced at any time with the ETS parameter value.
 If the object receives value 1, then the output status values for the scenes, the timer duration specifications and all the counter setpoints are reset to the values sent by the last download.
 For further information, see: [Restore ETS-Parameters](#).

No.	Name	Function of the object	Data type	Flags
231	Outputs 1-10: ON/OFF	Device LED switch off	1 bit - 1.001 DPT_Switch	C, R, W

This object is activated if the **Device LEDS lock-up** object parameter is active.
 This function is used to reduce the overall power consumption of the device. It allows the LEDs on the front of the device to be switched off.
 Object value: Depends on the **Polarity** parameter.

0 = Status indication, 1 = Always OFF:

- If the object receives value 0, the LED display is activated.
- If the object receives value 1, the LED display is deactivated.

0 = Always OFF, 1 = Status indication:

- If the object receives value 0, the LED display is deactivated.
- If the object receives value 1, the LED display is activated.

For further information, see: [LED display](#).

4.1.5 Diagnosis

No.	Name	Function of the object	Data type	Flags
232	Outputs 1-10	Diagnosis	6 byte - Specific	C, R, T

This object is activated when the **Device diagnosis object** parameter is active.

The object enables reporting of current faults according to the device and the application used. It also allows sending of the position of the switch on the front of the device and the number of the output that is affected by the fault(s).

Byte number	6 (MSB)	5	4	3	2	1(LSB)
Use	Switch position	Application type	Output number	Error codes		

This object is sent periodically and/or on status change.

For further information, see: [Diagnosis](#).

4.2 Output communication objects

	Number	Name	Function of the object	Length	C	R	W	T
	0	Output 1	ON/OFF	1 bit	C	R	W	-
	1	Output 1	Timer/toggle switch changeover	1 bit	C	R	W	-
	2	Output 1	Time limited toggle switch object	1 bit	C	R	W	-
	3	Output 1	Status indication ON/OFF	1 bit	C	R	-	T
	4	Output 1	Timer	1 bit	C	R	W	-
	5	Output 1	Timer duration	3 byte	C	R	W	-
	6	Output 1	Scene	1 byte	C	R	W	-
	7	Output 1	Preset 1	1 bit	C	R	W	-
	8	Output 1	Preset 2	1 bit	C	R	W	-
	9	Output 1	Preset 1 authorization	1 bit	C	R	W	-
	10	Output 1	Preset 2 authorization	1 bit	C	R	W	-
	11	Output 1	Lock-up 1	1 bit	C	R	W	-
	12	Output 1	Lock-up 2	1 bit	C	R	W	-
	13	Output 1	Status indication lock-up	1 bit	C	R	-	T
	14	Output 1	Priority	2 bit	C	R	W	-
	15	Output 1	Status indication priority	1 bit	C	R	-	T
	16	Output 1	Hours counter value	2 byte	C	R	-	T
	17	Output 1	Reset hours counter value	1 bit	C	R	W	-
	18	Output 1	Hours counter setpoint reached	1 bit	C	R	-	T
	19	Output 1	Hours counter setpoint	2 byte	C	R	W	-
	20	Output 2	ON/OFF	1 bit	C	R	W	-
	21	Output 2	Timer/toggle switch changeover	1 bit	C	R	W	-
	22	Output 2	Time limited toggle switch object	1 bit	C	R	W	-
	23	Output 2	Status indication ON/OFF	1 bit	C	R	-	T
	24	Output 2	Timer	1 bit	C	R	W	-
	25	Output 2	Timer duration	3 byte	C	R	W	-
	26	Output 2	Scene	1 byte	C	R	W	-
	27	Output 2	Preset 1	1 bit	C	R	W	-
	28	Output 2	Preset 2	1 bit	C	R	W	-
	29	Output 2	Preset 1 authorization	1 bit	C	R	W	-
	30	Output 2	Preset 2 authorization	1 bit	C	R	W	-
	31	Output 2	Lock-up 1	1 bit	C	R	W	-
	32	Output 2	Lock-up 2	1 bit	C	R	W	-
	33	Output 2	Status indication lock-up	1 bit	C	R	-	T
	34	Output 2	Priority	2 bit	C	R	W	-
	35	Output 2	Status indication priority	1 bit	C	R	-	T
	36	Output 2	Hours counter value	2 byte	C	R	-	T
	37	Output 2	Reset hours counter value	1 bit	C	R	W	-
	38	Output 2	Hours counter setpoint reached	1 bit	C	R	-	T
	39	Output 2	Hours counter setpoint	2 byte	C	R	W	-

	Number	Name	Function of the object	Length	C	R	W	T
	40	Output 3	ON/OFF	1 bit	C	R	W	-
	41	Output 3	Timer/toggle switch changeover	1 bit	C	R	W	-
	42	Output 3	Time limited toggle switch object	1 bit	C	R	W	-
	43	Output 3	Status indication ON/OFF	1 bit	C	R	-	T
	44	Output 3	Timer	1 bit	C	R	W	-
	45	Output 3	Timer duration	3 byte	C	R	W	-
	46	Output 3	Scene	1 byte	C	R	W	-
	47	Output 3	Preset 1	1 bit	C	R	W	-
	48	Output 3	Preset 2	1 bit	C	R	W	-
	49	Output 3	Preset 1 authorization	1 bit	C	R	W	-
	50	Output 3	Preset 2 authorization	1 bit	C	R	W	-
	51	Output 3	Lock-up 1	1 bit	C	R	W	-
	52	Output 3	Lock-up 2	1 bit	C	R	W	-
	53	Output 3	Status indication lock-up	1 bit	C	R	-	T
	54	Output 3	Priority	2 bit	C	R	W	-
	55	Output 3	Status indication priority	1 bit	C	R	-	T
	56	Output 3	Hours counter value	2 byte	C	R	-	T
	57	Output 3	Reset hours counter value	1 bit	C	R	W	-
	58	Output 3	Hours counter setpoint reached	1 bit	C	R	-	T
	59	Output 3	Hours counter setpoint	2 byte	C	R	W	-
	60	Output 4	ON/OFF	1 bit	C	R	W	-
	61	Output 4	Timer/toggle switch changeover	1 bit	C	R	W	-
	62	Output 4	Time limited toggle switch object	1 bit	C	R	W	-
	63	Output 4	Status indication ON/OFF	1 bit	C	R	-	T
	64	Output 4	Timer	1 bit	C	R	W	-
	65	Output 4	Timer duration	3 byte	C	R	W	-
	66	Output 4	Scene	1 byte	C	R	W	-
	67	Output 4	Preset 1	1 bit	C	R	W	-
	68	Output 4	Preset 2	1 bit	C	R	W	-
	69	Output 4	Preset 1 authorization	1 bit	C	R	W	-
	70	Output 4	Preset 2 authorization	1 bit	C	R	W	-
	71	Output 4	Lock-up 1	1 bit	C	R	W	-
	72	Output 4	Lock-up 2	1 bit	C	R	W	-
	73	Output 4	Status indication lock-up	1 bit	C	R	-	T
	74	Output 4	Priority	2 bit	C	R	W	-
	75	Output 4	Status indication priority	1 bit	C	R	-	T
	76	Output 4	Hours counter value	2 byte	C	R	-	T
	77	Output 4	Reset hours counter value	1 bit	C	R	W	-
	78	Output 4	Hours counter setpoint reached	1 bit	C	R	-	T
	79	Output 4	Hours counter setpoint	2 byte	C	R	W	-

	Number	Name	Function of the object	Length	C	R	W	T
	80	Output 5	ON/OFF	1 bit	C	R	W	-
	81	Output 5	Timer/toggle switch changeover	1 bit	C	R	W	-
	82	Output 5	Time limited toggle switch object	1 bit	C	R	W	-
	83	Output 5	Status indication ON/OFF	1 bit	C	R	-	T
	84	Output 5	Timer	1 bit	C	R	W	-
	85	Output 5	Timer duration	3 byte	C	R	W	-
	86	Output 5	Scene	1 byte	C	R	W	-
	87	Output 5	Preset 1	1 bit	C	R	W	-
	88	Output 5	Preset 2	1 bit	C	R	W	-
	89	Output 5	Preset 1 authorization	1 bit	C	R	W	-
	90	Output 5	Preset 2 authorization	1 bit	C	R	W	-
	91	Output 5	Lock-up 1	1 bit	C	R	W	-
	92	Output 5	Lock-up 2	1 bit	C	R	W	-
	93	Output 5	Status indication lock-up	1 bit	C	R	-	T
	94	Output 5	Priority	2 bit	C	R	W	-
	95	Output 5	Status indication priority	1 bit	C	R	-	T
	96	Output 5	Hours counter value	2 byte	C	R	-	T
	97	Output 5	Reset hours counter value	1 bit	C	R	W	-
	98	Output 5	Hours counter setpoint reached	1 bit	C	R	-	T
	99	Output 5	Hours counter setpoint	2 byte	C	R	W	-
	100	Output 6	ON/OFF	1 bit	C	R	W	-
	101	Output 6	Timer/toggle switch changeover	1 bit	C	R	W	-
	102	Output 6	Time limited toggle switch object	1 bit	C	R	W	-
	103	Output 6	Status indication ON/OFF	1 bit	C	R	-	T
	104	Output 6	Timer	1 bit	C	R	W	-
	105	Output 6	Timer duration	3 byte	C	R	W	-
	106	Output 6	Scene	1 byte	C	R	W	-
	107	Output 6	Preset 1	1 bit	C	R	W	-
	108	Output 6	Preset 2	1 bit	C	R	W	-
	109	Output 6	Preset 1 authorization	1 bit	C	R	W	-
	110	Output 6	Preset 2 authorization	1 bit	C	R	W	-
	111	Output 6	Lock-up 1	1 bit	C	R	W	-
	112	Output 6	Lock-up 2	1 bit	C	R	W	-
	113	Output 6	Status indication lock-up	1 bit	C	R	-	T
	114	Output 6	Priority	2 bit	C	R	W	-
	115	Output 6	Status indication priority	1 bit	C	R	-	T
	116	Output 6	Hours counter value	2 byte	C	R	-	T
	117	Output 6	Reset hours counter value	1 bit	C	R	W	-
	118	Output 6	Hours counter setpoint reached	1 bit	C	R	-	T
	119	Output 6	Hours counter setpoint	2 byte	C	R	W	-

	Number	Name	Function of the object	Length	C	R	W	T
	120	Output 7	ON/OFF	1 bit	C	R	W	-
	121	Output 7	Timer/toggle switch changeover	1 bit	C	R	W	-
	122	Output 7	Time limited toggle switch object	1 bit	C	R	W	-
	123	Output 7	Status indication ON/OFF	1 bit	C	R	-	T
	124	Output 7	Timer	1 bit	C	R	W	-
	125	Output 7	Timer duration	3 byte	C	R	W	-
	126	Output 7	Scene	1 byte	C	R	W	-
	127	Output 7	Preset 1	1 bit	C	R	W	-
	128	Output 7	Preset 2	1 bit	C	R	W	-
	129	Output 7	Preset 1 authorization	1 bit	C	R	W	-
	130	Output 7	Preset 2 authorization	1 bit	C	R	W	-
	131	Output 7	Lock-up 1	1 bit	C	R	W	-
	132	Output 7	Lock-up 2	1 bit	C	R	W	-
	133	Output 7	Status indication lock-up	1 bit	C	R	-	T
	134	Output 7	Priority	2 bit	C	R	W	-
	135	Output 7	Status indication priority	1 bit	C	R	-	T
	136	Output 7	Hours counter value	2 byte	C	R	-	T
	137	Output 7	Reset hours counter value	1 bit	C	R	W	-
	138	Output 7	Hours counter setpoint reached	1 bit	C	R	-	T
	139	Output 7	Hours counter setpoint	2 byte	C	R	W	-
	140	Output 8	ON/OFF	1 bit	C	R	W	-
	141	Output 8	Timer/toggle switch changeover	1 bit	C	R	W	-
	142	Output 8	Time limited toggle switch object	1 bit	C	R	W	-
	143	Output 8	Status indication ON/OFF	1 bit	C	R	-	T
	144	Output 8	Timer	1 bit	C	R	W	-
	145	Output 8	Timer duration	3 byte	C	R	W	-
	146	Output 8	Scene	1 byte	C	R	W	-
	147	Output 8	Preset 1	1 bit	C	R	W	-
	148	Output 8	Preset 2	1 bit	C	R	W	-
	149	Output 8	Preset 1 authorization	1 bit	C	R	W	-
	150	Output 8	Preset 2 authorization	1 bit	C	R	W	-
	151	Output 8	Lock-up 1	1 bit	C	R	W	-
	152	Output 8	Lock-up 2	1 bit	C	R	W	-
	153	Output 8	Status indication lock-up	1 bit	C	R	-	T
	154	Output 8	Priority	2 bit	C	R	W	-
	155	Output 8	Status indication priority	1 bit	C	R	-	T
	156	Output 8	Hours counter value	2 byte	C	R	-	T
	157	Output 8	Reset hours counter value	1 bit	C	R	W	-
	158	Output 8	Hours counter setpoint reached	1 bit	C	R	-	T
	159	Output 8	Hours counter setpoint	2 byte	C	R	W	-

	Number	Name	Function of the object	Length	C	R	W	T
	160	Output 9	ON/OFF	1 bit	C	R	W	-
	161	Output 9	Timer/toggle switch changeover	1 bit	C	R	W	-
	162	Output 9	Time limited toggle switch object	1 bit	C	R	W	-
	163	Output 9	Status indication ON/OFF	1 bit	C	R	-	T
	164	Output 9	Timer	1 bit	C	R	W	-
	165	Output 9	Timer duration	3 byte	C	R	W	-
	166	Output 9	Scene	1 byte	C	R	W	-
	167	Output 9	Preset 1	1 bit	C	R	W	-
	168	Output 9	Preset 2	1 bit	C	R	W	-
	169	Output 9	Preset 1 authorization	1 bit	C	R	W	-
	170	Output 9	Preset 2 authorization	1 bit	C	R	W	-
	171	Output 9	Lock-up 1	1 bit	C	R	W	-
	172	Output 9	Lock-up 2	1 bit	C	R	W	-
	173	Output 9	Status indication lock-up	1 bit	C	R	-	T
	174	Output 9	Priority	2 bit	C	R	W	-
	175	Output 9	Status indication priority	1 bit	C	R	-	T
	176	Output 9	Hours counter value	2 byte	C	R	-	T
	177	Output 9	Reset hours counter value	1 bit	C	R	W	-
	178	Output 9	Hours counter setpoint reached	1 bit	C	R	-	T
	179	Output 9	Hours counter setpoint	2 byte	C	R	W	-
	180	Output 10	ON/OFF	1 bit	C	R	W	-
	181	Output 10	Timer/toggle switch changeover	1 bit	C	R	W	-
	182	Output 10	Time limited toggle switch object	1 bit	C	R	W	-
	183	Output 10	Status indication ON/OFF	1 bit	C	R	-	T
	184	Output 10	Timer	1 bit	C	R	W	-
	185	Output 10	Timer duration	3 byte	C	R	W	-
	186	Output 10	Scene	1 byte	C	R	W	-
	187	Output 10	Preset 1	1 bit	C	R	W	-
	188	Output 10	Preset 2	1 bit	C	R	W	-
	189	Output 10	Preset 1 authorization	1 bit	C	R	W	-
	190	Output 10	Preset 2 authorization	1 bit	C	R	W	-
	191	Output 10	Lock-up 1	1 bit	C	R	W	-
	192	Output 10	Lock-up 2	1 bit	C	R	W	-
	193	Output 10	Status indication lock-up	1 bit	C	R	-	T
	194	Output 10	Priority	2 bit	C	R	W	-
	195	Output 10	Status indication priority	1 bit	C	R	-	T
	196	Output 10	Hours counter value	2 byte	C	R	-	T
	197	Output 10	Reset hours counter value	1 bit	C	R	W	-
	198	Output 10	Hours counter setpoint reached	1 bit	C	R	-	T
	199	Output 10	Hours counter setpoint	2 byte	C	R	W	-

Note: For devices with additional outputs, object designation is identical. Only the object number differs.

4.2.1 ON/OFF

No.	Name	Function of the object	Data type	Flags
0, 20, 40, 60, 80, 100, 120, 140, 160, 180	Output x	ON/OFF	1 bit - 1.001 DPT_Switch	C, R, W

These objects are always activated. They enable switching of the output contact in accordance with the value that is sent via the KNX bus.

Object value: Object value: depends on the **Output contact** parameter.

Normally open:

- On input of an OFF command, the output relay contact opens.
- On input of an ON command, the output relay contact closes.

Normally closed:

- On input of an OFF command, the output relay contact closes.
- On input of an ON command, the output relay contact opens.

For further information, see: [Function selection](#).

4.2.2 ON/OFF timings function

No.	Name	Function of the object	Data type	Flags
1, 21, 41, 61, 81, 101, 121, 141, 161, 181	Output x	Timer/toggle switch changeover	1 bit - 1.001 DPT_Switch	C, R, W

This object is activated if the **Timer/toggle switch changeover for ON/OFF** object parameter is active.

This object is used to switch between a toggle switch and timer switch operation on the same pushbutton.

- If the **Timer/toggle switch changeover** object receives the value 1, the Toggle-switch mode function is activated. The ON/OFF switching of the output is performed as usual via the **ON/OFF** object.
- If the **Timer/toggle switch changeover** object receives the value 0, the Timer mode function is activated.
 - If the **ON/OFF** object receives the value 1, the output is switched ON. After expiry of a configurable time, the output is automatically switched OFF.
 - If the **ON/OFF** object receives the value 0, the output is switched OFF.

*Example: Switching function daytime and Time-limited OFF function at night.
During the day, the button is used as a switch. In the evenings, the button is used as a time-limited OFF switch, so that the light will turn off automatically.*

For further information, see: [ON/OFF timings function](#).

No.	Name	Function of the object	Data type	Flags
2, 22, 42, 62, 82, 102, 122, 142, 162, 182	Output x	Time limited toggle switch object	1 bit - 1.001 DPT_Switch	C, R, W

This object is activated when the **Additional time limited toggle switch function** parameter is active.

This object combines a timer function with a tripping Delay function.

- If the object receives the value 1, the output switches to ON for a configurable time period. After that period expires, the output switches to OFF.
- If the object receives the value 0, the output switches to OFF.

Note: The time-limited OFF function is generally used for lighting in cellars, attics and sheds.

For further information, see: [ON/OFF timings function](#).

4.2.3 Status indication

No.	Name	Function of the object	Data type	Flags
3, 23, 43, 63, 83, 103, 123, 143, 163, 183	Output x	Status indication ON/OFF	1 bit - 1.001 DPT_Switch	C, R, T
<p>This object is activated when the Status indication ON/OFF parameter is active. This object allows the status of the output contact to be sent from the device over the KNX bus. Object value: Depends on the Polarity parameter.</p> <p>0 = ON, 1 = OFF</p> <ul style="list-style-type: none"> - If the output relay is open, a telegram with logic value 1 is sent on the KNX bus. - If the output relay is closed, a telegram with logic value 0 is sent on the KNX bus. <p>0 = OFF, 1 = ON</p> <ul style="list-style-type: none"> - If the output relay is open, a telegram with logic value 0 is sent on the KNX bus. - If the output relay is closed, a telegram with logic value 1 is sent on the KNX bus. <p>This object is sent periodically and/or on status change.</p> <p>For further information, see: Status indication.</p>				

4.2.4 Timer

No.	Name	Function of the object	Data type	Flags
4, 24, 44, 64, 84, 104, 124, 144, 164, 184	Output x	Timer	1 bit - 1.001 DPT_Switch	C, R, W
<p>This object is activated when the Timer parameter is active. This object is used to activate the Timer function of the device via the KNX bus. Object value:</p> <ul style="list-style-type: none"> - If a rising edge (0 to 1) arrives at this object, the output switches for a configurable period. - If a falling edge (1 to 0) arrives at this object, the output remains in its current state. <p><i>Note: Depending on the configuration, the timer switching can be interrupted on the timer by a long press of the control button.</i> <i>Note: Depending on the configuration, the timer duration may be reset by input of a start command during timer operation.</i></p> <p>For further information, see: Timer.</p>				

No.	Name	Function of the object	Data type	Flags
5, 25, 45, 65, 85, 105, 125, 145, 165, 185	Output x	Timer duration	3 byte - 10.001 DPT_TimeOfDay	C, R, W

This object is activated if the **Timer duration modifiable through object** object parameter is active.
 This object can be used to configure the timer duration. The timer duration can thus be configured in accordance with a time of day.

Byte 3 (MSB)					Byte 2						Byte 1 (LSB)												
			Hours				Minutes						Seconds										
0	0	0	H	H	H	H	H	0	0	M	M	M	M	M	M	0	0	S	S	S	S	S	S

Fields	Code	Value	Units
Hours	Binary	0 to 23 (5 bit)	Hours
Minutes	Binary	0 to 59 (6 bit)	Minutes
Seconds	Binary	0 to 59 (6 bit)	Seconds

For further information, see: [Timer](#).

4.2.5 Scene

No.	Name	Function of the object	Data type	Flags
6, 26, 46, 66, 86, 106, 126, 146, 166, 186	Output x	Scene	1 byte - 17.001 DPT_SceneNumber	C, R, W

This object is activated when the **Scene** parameter is active.
 This object is used to recall or save a scene.
 Details on the format of the object are given below.

7	6	5	4	3	2	1	0
Learning	Not used	Scene number					

Bit 7: 0: The scene is called / 1: The scene is saved.
 Bit 6: Not used.
 Bit 5 to Bit 0: Scene numbers from 0 (Scene 1) to 63 (Scene 64).

For further information, see: [Scene](#).

4.2.6 Preset

No.	Name	Function of the object	Data type	Flags
7, 27, 47, 67, 87, 107, 127, 147, 167, 187	Output x	Preset 1	1 bit - 1.022 DPT_Scene_AB	C, R, W
<p>This object is activated if the Preset has value Active with preset 1-level object or Active with preset 2-level objects. With this object, several outputs can be set to a configurable predefined status. Object value:</p> <ul style="list-style-type: none"> - If the object receives value 0, the values of the parameters for Preset 1 = 0 are used. - If the object receives value 1, the values of the parameters for Preset 1 = 1 are used. <p>For further information, see: Preset ON/OFF.</p>				

No.	Name	Function of the object	Data type	Flags
8, 28, 48, 68, 88, 108, 128, 148, 168, 188	Output x	Preset 2	1 bit - 1.022 DPT_Scene_AB	C, R, W
<p>This object is activated if the Preset parameter has value Active with preset 2-level objects.</p> <p>See object No. 7</p>				

No.	Name	Function of the object	Data type	Flags
9, 29, 49, 69, 89, 109, 129, 149, 169, 189	Output x	Preset 1 authorization	1 bit - 1.003 DPT_Enable	C, R, W
<p>This object is activated if the Preset authorization objects parameter is active. This object allows the authorization or lock-up of the Preset 1 function via a KNX telegram. Object value: This is dependent on the Polarity of autorisation object Preset 1 parameter. 0 = Locked-up, 1 = Authorized:</p> <ul style="list-style-type: none"> - If the object receives the value 0, Preset 1 is deactivated. - If the object receives the value 1, Preset 1 is activated. <p>0 = Authorized, 1 = Locked-up:</p> <ul style="list-style-type: none"> - If the object receives the value 0, Preset 1 is activated. - If the object receives the value 1, Preset 1 is deactivated. <p>For further information, see: Preset ON/OFF.</p>				

No.	Name	Function of the object	Data type	Flags
10, 30, 50, 70, 90, 110, 130, 150, 170, 190	Output x	Preset 2 authorization	1 bit - 1.003 DPT_Enable	C, R, W
<p>See object No. 9</p>				

4.2.7 Lock-up

No.	Name	Function of the object	Data type	Flags
11, 31, 51, 71, 91, 111, 131, 151, 171, 191	Output x	Lock-up 1	1 bit - 1.003 DPT_Enable	C, R, W
<p>This object is activated if the Lock-up has value Active with 1 lock-up object or Active with 2 lock-up objects. This object is used to control the activation of the lock-up via the KNX bus. Object value: This is dependent on the Polarity of lock-up object 1 parameter. 0 = Lock-up activated, 1 = Lock-up deactivated:</p> <ul style="list-style-type: none"> - If the object receives value 0, the Lock-up is activated. - If the object receives value 1, the Lock-up is deactivated. <p>0 = Lock-up deactivated, 1 = Lock-up activated:</p> <ul style="list-style-type: none"> - If the object receives value 0, the Lock-up is deactivated. - If the object receives value 1, the Lock-up is activated. <p>For further information, see: Lock-up ON/OFF.</p>				

No.	Name	Function of the object	Data type	Flags
12, 32, 52, 72, 92, 112, 132, 152, 171, 192	Output x	Lock-up 2	1 bit - 1.003 DPT_Enable	C, R, W
<p>This object is activated if the Lock-up parameter has value Active with 2 lock-up objects.</p> <p>See object No. 11.</p>				

No.	Name	Function of the object	Data type	Flags
13, 33, 53, 73, 93, 113, 133, 153, 173, 193	Output x	Status indication lock-up	1 bit - 1.011 DPT_Switch	C, R, T
<p>This object is activated when the Activation of lock-up status object parameter is active. This object allows the status of the lock-up to be sent from the device over the KNX bus. Object value: Depends on the Polarity parameter. 0 = Lock-up deactivated, 1 = Lock-up activated:</p> <ul style="list-style-type: none"> - If the lock-up is deactivated, a telegram with logic value 0 is sent on the KNX bus. - If the lock-up is activated, a telegram with logic value 1 is sent on the KNX bus. <p>0 = Lock-up activated, 1 = Lock-up deactivated:</p> <ul style="list-style-type: none"> - If the lock-up is activated, a telegram with logic value 0 is sent on the KNX bus. - If the lock-up is deactivated, a telegram with logic value 1 is sent on the KNX bus. <p>This object is sent periodically and/or on status change. For further information, see: Lock-up ON/OFF.</p>				

4.2.8 Priority

No.	Name	Function of the object	Data type	Flags
14, 34, 54, 74, 94, 114, 134, 154, 174, 194	Output x	Priority	2 bit - 2.002 DPT_Bool_Control	C, R, W

This object is activated if the **Priority** parameter is active.
 The status of the output contact is determined directly by this object.
 Details on the format of the object are given below.

Telegram received by the priority operation object		Status of the outputs
Bit 1	Bit 2	
0	0	End of the priority
0	1	End of the priority
1	0	Priority OFF
1	1	Priority ON

The first bit of this object (Bit 0) determines the status of the output contact, which should be priority controlled. The second bit activates or deactivates the Priority.

For further information, see: [Priority ON/OFF](#).

No.	Name	Function of the object	Data type	Flags
15, 35, 55, 75, 95, 115, 135, 155, 175, 195	Output x	Status indication priority	1 bit - 1.011 DPT_Switch	C, R, T

This object is activated if the **Activation of priority status object** parameter is active.
 This object allows the status of the Priority to be sent from the device on the KNX bus.
 Object value: Depends on the **Polarity** parameter.

0 = Not forced, 1 = Forced:

- If Priority is deactivated, a telegram is sent with logic value 0.
- If Priority is activated, a telegram is sent with logic value 1.

0 = Forced, 1 = Not forced:

- If Priority is activated, a telegram is sent with logic value 0.
- If Priority is deactivated, a telegram is sent with logic value 1.

This object is sent periodically and/or on status change.

For further information, see: [Priority ON/OFF](#).

4.2.9 Hours counter

No.	Name	Function of the object	Data type	Flags
16, 36, 56, 76, 96, 116, 136, 156, 176, 196	Output x	Hours counter value	2 byte - 7.001 DPT_16_bit_Counter	C, R, T

This object is activated when the **Hours counter** parameter is active.
 This object allows the value of the operating hours to be sent from the device on the KNX bus.
 The count value is saved during a power cut on the KNX bus. It is submitted after return of power to the bus or after an ETS download.
 Object value: 0 to 65535 hours.

This object is sent periodically and/or on status change.
 For further information, see: [Hours counter](#).

No.	Name	Function of the object	Data type	Flags
17, 37, 57, 77, 97, 117, 137, 157, 177, 197	Output x	Reset hours counter value	1 bit - 1.015 DPT_Reset	C, R, W

This object is activated when the **Hours counter** parameter is active.
 This object enables the hours counter value to be reset.
 Object value:

- If the object receives the value 0, the counter is not reset.
- If the object receives the value 1, the counter is reset.

For further information, see: [Hours counter](#).

No.	Name	Function of the object	Data type	Flags
18, 38, 58, 78, 98, 118, 138, 158, 178, 198	Output x	Hours counter setpoint reached	1 bit - 1.002 DPT_Bool	C, R, T

This object is activated when the **Hours counter** parameter is active.
 This object reports that the hours counter has reached its setpoint.

- Incrementing counter: Counter = Counter value setpoint.
- Countdown counter: Counter = 0.

Object value: If the setpoint is reached, a telegram with logic value 1 is sent on the KNX bus.
 The count value is saved during a power cut on the KNX bus. It is submitted after return of power to the bus or after an ETS download.

This object is sent periodically and/or on status change.
 For further information, see: [Hours counter](#).

No.	Name	Function of the object	Data type	Flags
19, 39, 59, 79, 99, 119, 139, 159, 179, 199	Output x	Counter value setpoint	2 byte - 7.001 DPT_16_bit_Counter	C, R, W

This object is activated if the **Counter setpoint value modifiable through object** object parameter is active. This object is used to initialize the counter setpoint of the hours counter via the KNX bus.
 Object value: 0 to 65535 hours.

This object is sent periodically and/or on status change.
 For further information, see: [Hours counter](#).

4.3 Communication objects for each shutter/blind output

	Number	Name	Function of the object	Length	C	R	W	T
	0	Outputs 1-2	Up/Down (long key-press)	1 bit	C	R	W	-
	1	Outputs 1-2	Step/stop (short press)	1 bit	C	R	W	-
	2	Outputs 1-2	Position in %	1 byte	C	R	W	-
	3	Outputs 1-2	Slat angle (0-100%)	1 byte	C	R	W	-
	4	Outputs 1-2	Position in % indication	1 byte	C	R	-	T
	5	Outputs 1-2	Slat angle indication in %	1 byte	C	R	-	T
	6	Outputs 1-2	Upper position reached	1 bit	C	R	-	T
	7	Outputs 1-2	Lower position reached	1 bit	C	R	-	T
	8	Outputs 1-2	Scene	1 byte	C	R	W	-
	9	Outputs 1-2	Preset 1	1 bit	C	R	W	-
	10	Outputs 1-2	Preset 2	1 bit	C	R	W	-
	11	Outputs 1-2	Preset 1 authorization	1 bit	C	R	W	-
	12	Outputs 1-2	Preset 2 authorization	1 bit	C	R	W	-
	13	Outputs 1-2	Lock-up 1	1 bit	C	R	W	-
	14	Outputs 1-2	Lock-up 2	1 bit	C	R	W	-
	15	Outputs 1-2	Status indication lock-up	1 bit	C	R	-	T
	16	Outputs 1-2	Priority	2 bit	C	R	W	-
	17	Outputs 1-2	Status indication priority	1 bit	C	R	-	T
	18	Outputs 1-2	Alarm 1	1 bit	C	R	W	-
	19	Outputs 1-2	Alarm 2	1 bit	C	R	W	-
	20	Outputs 1-2	Alarm 3	1 bit	C	R	W	-
	21	Outputs 1-2	Alarm status object	1 bit	C	R	-	T
	22	Outputs 1-2	Sun protection position %	1 byte	C	R	W	-
	23	Outputs 1-2	Pos. lamelles poursuite sol. %	1 byte	C	R	W	-
	24	Outputs 1-2	Sun protection authorization	1 bit	C	R	W	-
	25	Outputs 1-2	Sun protection reactivation	1 bit	C	R	W	-
	26	Outputs 1-2	Sun protection status	1 bit	C	R	-	T

	Number	Name	Function of the object	Length	C	R	W	T
	40	Outputs 3-4	Up/Down (long key-press)	1 bit	C	R	W	-
	41	Outputs 3-4	Step/stop (short press)	1 bit	C	R	W	-
	42	Outputs 3-4	Position in %	1 byte	C	R	W	-
	43	Outputs 3-4	Slat angle (0-100%)	1 byte	C	R	W	-
	44	Outputs 3-4	Position in % indication	1 byte	C	R	-	T
	45	Outputs 3-4	Slat angle indication in %	1 byte	C	R	-	T
	46	Outputs 3-4	Upper position reached	1 bit	C	R	-	T
	47	Outputs 3-4	Lower position reached	1 bit	C	R	-	T
	48	Outputs 3-4	Scene	1 byte	C	R	W	-
	49	Outputs 3-4	Preset 1	1 bit	C	R	W	-
	50	Outputs 3-4	Preset 2	1 bit	C	R	W	-
	51	Outputs 3-4	Preset 1 authorization	1 bit	C	R	W	-
	52	Outputs 3-4	Preset 2 authorization	1 bit	C	R	W	-
	53	Outputs 3-4	Lock-up 1	1 bit	C	R	W	-
	54	Outputs 3-4	Lock-up 2	1 bit	C	R	W	-
	55	Outputs 3-4	Status indication lock-up	1 bit	C	R	-	T
	56	Outputs 3-4	Priority	2 bit	C	R	W	-
	57	Outputs 3-4	Status indication priority	1 bit	C	R	-	T
	58	Outputs 3-4	Alarm 1	1 bit	C	R	W	-
	59	Outputs 3-4	Alarm 2	1 bit	C	R	W	-
	60	Outputs 3-4	Alarm 3	1 bit	C	R	W	-
	61	Outputs 3-4	Alarm status object	1 bit	C	R	-	T
	62	Outputs 3-4	Sun protection position %	1 byte	C	R	W	-
	63	Outputs 3-4	Pos. lamelles poursuite sol. %	1 byte	C	R	W	-
	64	Outputs 3-4	Sun protection authorization	1 bit	C	R	W	-
	65	Outputs 3-4	Sun protection reactivation	1 bit	C	R	W	-
	66	Outputs 3-4	Sun protection status	1 bit	C	R	-	T

	Number	Name	Function of the object	Length	C	R	W	T
	80	Outputs 5-6	Up/Down (long key-press)	1 bit	C	R	W	-
	81	Outputs 5-6	Step/stop (short press)	1 bit	C	R	W	-
	82	Outputs 5-6	Position in %	1 byte	C	R	W	-
	83	Outputs 5-6	Slat angle (0-100%)	1 byte	C	R	W	-
	84	Outputs 5-6	Position in % indication	1 byte	C	R	-	T
	85	Outputs 5-6	Slat angle indication in %	1 byte	C	R	-	T
	86	Outputs 5-6	Upper position reached	1 bit	C	R	-	T
	87	Outputs 5-6	Lower position reached	1 bit	C	R	-	T
	88	Outputs 5-6	Scene	1 byte	C	R	W	-
	89	Outputs 5-6	Preset 1	1 bit	C	R	W	-
	90	Outputs 5-6	Preset 2	1 bit	C	R	W	-
	91	Outputs 5-6	Preset 1 authorization	1 bit	C	R	W	-
	92	Outputs 5-6	Preset 2 authorization	1 bit	C	R	W	-
	93	Outputs 5-6	Lock-up 1	1 bit	C	R	W	-
	94	Outputs 5-6	Lock-up 2	1 bit	C	R	W	-
	95	Outputs 5-6	Status indication lock-up	1 bit	C	R	-	T
	96	Outputs 5-6	Priority	2 bit	C	R	W	-
	97	Outputs 5-6	Status indication priority	1 bit	C	R	-	T
	98	Outputs 5-6	Alarm 1	1 bit	C	R	W	-
	99	Outputs 5-6	Alarm 2	1 bit	C	R	W	-
	100	Outputs 5-6	Alarm 3	1 bit	C	R	W	-
	101	Outputs 5-6	Alarm status object	1 bit	C	R	-	T
	102	Outputs 5-6	Sun protection position %	1 byte	C	R	W	-
	103	Outputs 5-6	Pos. lamelles poursuite sol. %	1 byte	C	R	W	-
	104	Outputs 5-6	Sun protection authorization	1 bit	C	R	W	-
	105	Outputs 5-6	Sun protection reactivation	1 bit	C	R	W	-
	106	Outputs 5-6	Sun protection status	1 bit	C	R	-	T

	Number	Name	Function of the object	Length	C	R	W	T
	120	Outputs 7-8	Up/Down (long key-press)	1 bit	C	R	W	-
	121	Outputs 7-8	Step/stop (short press)	1 bit	C	R	W	-
	122	Outputs 7-8	Position in %	1 byte	C	R	W	-
	123	Outputs 7-8	Slat angle (0-100%)	1 byte	C	R	W	-
	124	Outputs 7-8	Position in % indication	1 byte	C	R	-	T
	125	Outputs 7-8	Slat angle indication in %	1 byte	C	R	-	T
	126	Outputs 7-8	Upper position reached	1 bit	C	R	-	T
	127	Outputs 7-8	Lower position reached	1 bit	C	R	-	T
	128	Outputs 7-8	Scene	1 byte	C	R	W	-
	129	Outputs 7-8	Preset 1	1 bit	C	R	W	-
	130	Outputs 7-8	Preset 2	1 bit	C	R	W	-
	131	Outputs 7-8	Preset 1 authorization	1 bit	C	R	W	-
	132	Outputs 7-8	Preset 2 authorization	1 bit	C	R	W	-
	133	Outputs 7-8	Lock-up 1	1 bit	C	R	W	-
	134	Outputs 7-8	Lock-up 2	1 bit	C	R	W	-
	135	Outputs 7-8	Status indication lock-up	1 bit	C	R	-	T
	136	Outputs 7-8	Priority	2 bit	C	R	W	-
	137	Outputs 7-8	Status indication priority	1 bit	C	R	-	T
	138	Outputs 7-8	Alarm 1	1 bit	C	R	W	-
	139	Outputs 7-8	Alarm 2	1 bit	C	R	W	-
	140	Outputs 7-8	Alarm 3	1 bit	C	R	W	-
	141	Outputs 7-8	Alarm status object	1 bit	C	R	-	T
	142	Outputs 7-8	Sun protection position %	1 byte	C	R	W	-
	143	Outputs 7-8	Pos. lamelles poursuite sol. %	1 byte	C	R	W	-
	144	Outputs 7-8	Sun protection authorization	1 bit	C	R	W	-
	145	Outputs 7-8	Sun protection reactivation	1 bit	C	R	W	-
	146	Outputs 7-8	Sun protection status	1 bit	C	R	-	T

	Number	Name	Function of the object	Length	C	R	W	T
	160	Outputs 9-10	Up/Down (long key-press)	1 bit	C	R	W	-
	161	Outputs 9-10	Step/stop (short press)	1 bit	C	R	W	-
	162	Outputs 9-10	Position in %	1 byte	C	R	W	-
	163	Outputs 9-10	Slat angle (0-100%)	1 byte	C	R	W	-
	164	Outputs 9-10	Position in % indication	1 byte	C	R	-	T
	165	Outputs 9-10	Slat angle indication in %	1 byte	C	R	-	T
	166	Outputs 9-10	Upper position reached	1 bit	C	R	-	T
	167	Outputs 9-10	Lower position reached	1 bit	C	R	-	T
	168	Outputs 9-10	Scene	1 byte	C	R	W	-
	169	Outputs 9-10	Preset 1	1 bit	C	R	W	-
	170	Outputs 9-10	Preset 2	1 bit	C	R	W	-
	171	Outputs 9-10	Preset 1 authorization	1 bit	C	R	W	-
	172	Outputs 9-10	Preset 2 authorization	1 bit	C	R	W	-
	173	Outputs 9-10	Lock-up 1	1 bit	C	R	W	-
	174	Outputs 9-10	Lock-up 2	1 bit	C	R	W	-
	175	Outputs 9-10	Status indication lock-up	1 bit	C	R	-	T
	176	Outputs 9-10	Priority	2 bit	C	R	W	-
	177	Outputs 9-10	Status indication priority	1 bit	C	R	-	T
	178	Outputs 9-10	Alarm 1	1 bit	C	R	W	-
	179	Outputs 9-10	Alarm 2	1 bit	C	R	W	-
	180	Outputs 9-10	Alarm 3	1 bit	C	R	W	-
	181	Outputs 9-10	Alarm status object	1 bit	C	R	-	T
	182	Outputs 9-10	Sun protection position %	1 byte	C	R	W	-
	183	Outputs 9-10	Pos. lamelles poursuite sol. %	1 byte	C	R	W	-
	184	Outputs 9-10	Sun protection authorization	1 bit	C	R	W	-
	185	Outputs 9-10	Sun protection reactivation	1 bit	C	R	W	-
	186	Outputs 9-10	Sun protection status	1 bit	C	R	-	T

Note: For devices with additional outputs, object designation is identical. Only the object number differs.

4.3.1 Control

No.	Name	Function of the object	Data type	Flags
0, 40, 80, 120, 160	Output x-y	Up/Down (long key-press)	1 bit - 1.008 DPT_UpDown	C, R, W

These objects are always activated. It is used to control the shutter or blind in connection with the value that is sent on the KNX bus.

Object value:

- If the object receives value 0, the shutter or blind moves to the upper position.
- If the object receives value 1, the shutter or blind moves to the lower position.

For further information, see: [Functions for each shutter/blind output](#).

No.	Name	Function of the object	Data type	Flags
1, 41, 81, 121, 161	Output x-y	Step/stop (short press)	1 bit - 1.007 DPT_Step	C, R, W

These objects are always activated. It is used to stop the movement of the shutter or blind or the tilting of the slats according to the value that is sent on the KNX bus.

Object value:

- Regardless of which value (0 or 1) is sent to this object, the movement of the shutter or blind will be stopped.
- If the object receives the value 0, the slats will be opened by one slat step.
- If the object receives the value 1, the slats will be closed by one slat step.

For further information, see: [Function selection](#).

No.	Name	Function of the object	Data type	Flags
2, 42, 82, 122, 162	Output x-y	Position in %	1 byte - 5.001 DPT_Scaling	C, R, W

These objects are always activated. It is used for positioning the shutter or blind at the desired height, in response to the value sent on the KNX bus.

On the blind, the slats have the same tilt after reaching the same position as they had before the movement.

If a telegram is received during the movement of the shutter or blind, the shutter will be positioned at the desired height after the originally requested position has been reached.

Object value: 0 to 255

- 0 (0%): Upper position
- 255 (100%): Lower position

For further information, see: [Function selection](#).

No.	Name	Function of the object	Data type	Flags
3, 43, 83, 123, 163	Output x-y	Slat angle in %	1 byte - 5.001 DPT_Scaling	C, R, W

These objects are always activated. It is used to position the shutter or blind in response to the value that is sent on the KNX bus.

Object value: 0 to 255

- 0 (0%): Slats open
- 255 (100%): Slats closed

For further information, see: [Function selection](#).

4.3.2 Status indication

No.	Name	Function of the object	Data type	Flags
4, 44, 84, 124, 164	Output x-y	Position in % indication	1 byte - 5.001 DPT_Scaling	C, R, T
<p>This object is activated when the Status indication position in % parameter is active. This object allows the status of the position to be sent over the KNX bus. It is sent after the position of the blind or shutter has been achieved.</p> <p>Object value: 0 to 255</p> <ul style="list-style-type: none"> - 0 (0%): Upper position - 255 (100%): Lower position <p>This object is sent periodically and/or on status change. For further information, see: Status indication Shutter.</p>				

No.	Name	Function of the object	Data type	Flags
5, 45, 85, 125, 165	Output x-y	Slat angle indication in %	1 byte - 5.001 DPT_Scaling	C, R, T
<p>This object is activated when the Status indication slat angle in % parameter is active. This object allows the status of the slat angle to be sent over the KNX bus. It is sent after the tilting of the blind has been achieved.</p> <p>Object value: 0 to 255</p> <ul style="list-style-type: none"> - 0 (0%): Slats open - 255 (100%): Slats closed <p>This object is sent periodically and/or on status change. For further information, see: Status indication Shutter.</p>				

No.	Name	Function of the object	Data type	Flags
6, 46, 86, 126, 166	Output x-y	Upper position reached	1 bit - 1.002 DPT_Bool	C, R, T

This object is activated when the **Upper position reached objects** parameter is active.
 This object is used to send the status of the upper position of the shutter or blind over the KNX bus.
 Object value: Depends on the **Polarity** parameter.

0 = Position not reached, 1 = Position reached

- If the upper position of the shutter or blind is not reached, a telegram is sent with a logic value of 0 on the KNX bus.
- If the upper position of the shutter or blind is reached, a telegram is sent with a logic value of 1 on the KNX bus.

0 = Position reached, 1 = Position not reached

- If the upper position of the shutter or blind is reached, a telegram is sent with a logic value of 0 on the KNX bus.
- If the upper position of the shutter or blind is not reached, a telegram is sent with a logic value of 1 on the KNX bus

This object is sent periodically and/or on status change.

For further information, see: [Status indication Shutter](#).

No.	Name	Function of the object	Data type	Flags
7, 47, 87, 127, 167	Output x-y	Lower position reached	1 bit - 1.002 DPT_Bool	C, R, T

This object is activated if the **Lower position reached objects** parameter is active.
 This object is used to send the status of the lower position of the shutter or blind over the KNX bus.
 Object value: Depends on the **Polarity** parameter.

0 = Position not reached, 1 = Position reached

- If the lower position of the shutter or blind is not reached, a telegram is sent with a logic value of 0 on the KNX bus.
- If the lower position of the shutter or blind is reached, a telegram is sent with a logic value of 1 on the KNX bus.

0 = Position reached, 1 = Position not reached

- If the lower position of the shutter or blind is reached, a telegram is sent with a logic value of 0 on the KNX bus.
- If the lower position of the shutter or blind is not reached, a telegram is sent with a logic value of 1 on the KNX bus

This object is sent periodically and/or on status change.

For further information, see: [Status indication Shutter](#).

4.3.3 Scene

No.	Name	Function of the object	Data type	Flags																
8, 48, 88, 128, 168	Output x-y	Scene	1 byte - 17.001 DPT_SceneNumber	C, R, W																
<p>This object is activated when the Scene parameter is active. This object is used to recall or save a scene. Details on the format of the object are given below.</p> <table border="1" style="margin-left: auto; margin-right: auto;"> <tr> <td style="text-align: center;">7</td> <td style="text-align: center;">6</td> <td style="text-align: center;">5</td> <td style="text-align: center;">4</td> <td style="text-align: center;">3</td> <td style="text-align: center;">2</td> <td style="text-align: center;">1</td> <td style="text-align: center;">0</td> </tr> <tr> <td style="text-align: center;">Learning</td> <td style="text-align: center;">Not used</td> <td colspan="6" style="text-align: center;">Scene number</td> </tr> </table> <p>Bit 7: 0: The scene is called / 1: The scene is saved. Bit 6: Not used. Bit 5 to Bit 0: Scene numbers from 0 (Scene 1) to 63 (Scene 64).</p> <p>For further information, see: Scene Shutter.</p>					7	6	5	4	3	2	1	0	Learning	Not used	Scene number					
7	6	5	4	3	2	1	0													
Learning	Not used	Scene number																		

4.3.4 Preset

No.	Name	Function of the object	Data type	Flags
9, 49, 89, 129, 169	Output x-y	Preset 1	1 bit - 1.022 DPT_Scene_AB	C, R, W
<p>This object is activated if the Preset has value Active with preset 1-level object or Active with preset 2-level objects. With this object, several outputs can be set to a configurable predefined status.</p> <p>Object value:</p> <ul style="list-style-type: none"> - If the object receives value 0, the values of the parameters for Preset 1 = 0 are used. - If the object receives value 1, the values of the parameters for Preset 1 = 1 are used. <p>For further information, see: Preset Shutter.</p>				

No.	Name	Function of the object	Data type	Flags
10, 50, 90, 130, 170	Output x-y	Preset 2	1 bit - 1.022 DPT_Scene_AB	C, R, W
<p>This object is activated if the Preset parameter has value Active with preset 2-level objects.</p> <p>See object No. 9</p>				

No.	Name	Function of the object	Data type	Flags
11, 51, 91, 131, 171	Output x-y	Preset 1 authorization	1 bit - 1.003 DPT_Enable	C, R, W
<p>This object is activated if the Preset authorization objects parameter is active. This object allows the authorization or lock-up of the Preset 1 function via a KNX telegram. Object value: This is dependent on the Polarity of autorisation object Preset 1 parameter.</p> <p>0 = Locked-up, 1 = Authorized:</p> <ul style="list-style-type: none"> - If the object receives the value 0, Preset 1 is deactivated. - If the object receives the value 1, Preset 1 is activated. <p>0 = Authorized, 1 = Locked-up:</p> <ul style="list-style-type: none"> - If the object receives the value 0, Preset 1 is activated. - If the object receives the value 1, Preset 1 is deactivated. <p>For further information, see: Preset Shutter.</p>				

No.	Name	Function of the object	Data type	Flags
12, 52, 92, 132, 172	Output x-y	Preset 2 authorization	1 bit - 1.003 DPT_Enable	C, R, W
See object No. 11				

4.3.5 Lock-up

No.	Name	Function of the object	Data type	Flags
13, 53, 93, 133, 173	Output x	Lock-up 1	1 bit - 1.003 DPT_Enable	C, R, W
<p>This object is activated if the Lock-up has value Active with 1 lock-up object or Active with 2 lock-up objects. This object is used to control the activation of the lock-up via the KNX bus. Object value: This is dependent on the Polarity of lock-up object 1 parameter.</p> <p>0 = Lock-up activated, 1 = Lock-up deactivated:</p> <ul style="list-style-type: none"> - If the object receives value 0, the Lock-up is activated. - If the object receives value 1, the Lock-up is deactivated. <p>0 = Lock-up deactivated, 1 = Lock-up activated:</p> <ul style="list-style-type: none"> - If the object receives value 0, the Lock-up is deactivated. - If the object receives value 1, the Lock-up is activated. <p>For further information, see: Lock-up Shutter.</p>				

No.	Name	Function of the object	Data type	Flags
14, 54, 94, 134, 174	Output x	Lock-up 2	1 bit - 1.003 DPT_Enable	C, R, W
<p>This object is activated if the Lock-up parameter has value Active with 2 lock-up objects.</p> <p>See object No. 13.</p>				

No.	Name	Function of the object	Data type	Flags
15, 55, 95, 135, 175	Output x-y	Status indication lock-up	1 bit - 1.011 DPT_Switch	C, R, T

This object is activated when the **Activation of lock-up status object** parameter is active. This object allows the status of the lock-up to be sent from the device over the KNX bus. Object value: Depends on the **Polarity** parameter.

0 = Lock-up deactivated, 1 = Lock-up activated:

- If the lock-up is deactivated, a telegram with logic value 0 is sent on the KNX bus.
- If the lock-up is activated, a telegram with logic value 1 is sent on the KNX bus.

0 = Lock-up activated, 1 = Lock-up deactivated:

- If the lock-up is activated, a telegram with logic value 0 is sent on the KNX bus.
- If the lock-up is deactivated, a telegram with logic value 1 is sent on the KNX bus.

This object is sent periodically and/or on status change.

For further information, see: [Lock-up Shutter](#).

4.3.6 Priority

No.	Name	Function of the object	Data type	Flags
16, 56, 96, 136, 176	Output x-y	Priority	2 bit - 2.002 DPT_Bool_Control	C, R, W

This object is activated if the **Priority** parameter is active. The status of the output contact is determined directly by this object. Details on the format of the object are given below.

Telegram received by the priority operation object		Status of the outputs
Bit 1	Bit 2	
0	0	End of the priority
0	1	End of the priority
1	0	Priority OFF
1	1	Priority ON

The first bit of this object (Bit 0) determines the status of the output contact, which should be priority controlled. The second bit activates or deactivates the Priority.

For further information, see: [Priority Shutter](#).

No.	Name	Function of the object	Data type	Flags
17, 57, 97, 137, 177	Output x-y	Status indication priority	1 bit - 1.011 DPT_State	C, R, T
<p>This object is activated if the Activation of priority status object parameter is active. This object allows the status of the Priority to be sent from the device on the KNX bus. Object value: Depends on the Polarity parameter.</p> <p>0 = Not forced, 1 = Forced:</p> <ul style="list-style-type: none"> - If Priority is deactivated, a telegram is sent with logic value 0. - If Priority is activated, a telegram is sent with logic value 1. <p>0 = Forced, 1 = Not forced:</p> <ul style="list-style-type: none"> - If Priority is activated, a telegram is sent with logic value 0. - If Priority is deactivated, a telegram is sent with logic value 1. <p>This object is sent periodically and/or on status change. For further information, see: Priority Shutter.</p>				

4.3.7 Alarm

No.	Name	Function of the object	Data type	Flags
18, 58, 98, 138, 178	Output x-y	Alarm 1	1 bit - 1.005 DPT_Alarm	C, R, W
<p>This object is only visible if the Alarm parameter has the following value: 1 alarm object or 2 alarm objects or 3 alarm objects. This object is used to switch the output back to the predefined settings.</p> <p>Object value:</p> <ul style="list-style-type: none"> - If the object receives the value 0, the alarm is not activated. - -If the object receives the value 1, the alarm is activated. <p>For further information, see: Alarm.</p>				

No.	Name	Function of the object	Data type	Flags
19, 59, 99, 139, 179	Output x-y	Alarm 2	1 bit - 1.005 DPT_Alarm	C, R, W
See object No. 18.				

No.	Name	Function of the object	Data type	Flags
20, 60, 100, 140, 180	Output x-y	Alarm 3	1 bit - 1.005 DPT_Alarm	C, R, W
See object No. 18.				

No.	Name	Function of the object	Data type	Flags
21, 61, 101, 141, 181	Output x-y	Alarm status indication	1 bit - 1.011 DPT_State	C, R, T

This object is activated when the **Alarm status object** parameter is active.
 This object allows the status of the alarm angle to be sent over the KNX bus.
 Object value: Depends on the **Polarity** parameter.

0 = Alarm deactivated, 1 = Alarm activated

- If all the alarms are deactivated, a telegram with logic value 0 is sent on the KNX bus.
- If one of the three alarms is activated, a telegram with logic value 1 is sent on the KNX bus.

0 = Alarm activated, 1 = Alarm deactivated

- If one of the three alarms is activated, a telegram with logic value 0 is sent on the KNX bus.
- If all the alarms are deactivated, a telegram with logic value 1 is sent on the KNX bus.

This object is sent periodically and/or on status change.

For further information, see: [Alarm](#).

4.3.8 Sun protection

No.	Name	Function of the object	Data type	Flags
22, 62, 102, 142, 182	Output x-y	Sun protection position %	1 byte - 5.001 DPT_Scaling	C, R, W

This object is only visible if the **Sun protection type** parameter has the following value: **Objects position and slat angle** or **Position object only**.

It is used for positioning the shutter or blind at the desired height, in response to the value sent on the KNX bus.

As a general rule, this object is connected with an external device, which sends a position value to the shutter or blind in response to the elevation of the sun.

Object value: 0 to 255

- 0 (0%): Upper position
- 255 (100%): Lower position

For further information, see: [Sun protection](#).

No.	Name	Function of the object	Data type	Flags
23, 63, 103, 143, 183	Output x-y	Slat angle (0-100%)	1 byte - 5.001 DPT_Scaling	C, R, W

This object is only visible if the **Sun protection type** parameter has the following value: **Objects position and slat angle** or **Slat angle object only**.

This object is used to position the shutter or blind in response to the value that is sent on the KNX bus.

As a general rule, this object is connected with an external device, which sends a slat angle value to the blind in response to the elevation of the sun.

Object value: 0 to 255

- 0 (0%): Slats open
- 255 (100%): Slats closed

For further information, see: [Sun protection](#).

No.	Name	Function of the object	Data type	Flags
24, 64, 104, 144, 184	Output x-y	Sun protection authorization	1 bit - 1.003 DPT_Enable	C, R, W

This object is activated if the **Sun protection authorization** object parameter is active.
 This object allows the sun protection status of the alarm function of the device to be activated or deactivated over the KNX bus.
 Object value: Depends on the **Polarity** parameter.

0 = Locked-up, 1 = Authorized

- If the object receives the value 0, the sun protection is deactivated.
- If the object receives the value 1, the sun protection is activated.

0 = Authorized, 1 = Locked-up

- If the object receives the value 0, the sun protection is activated.
- If the object receives the value 1, the sun protection is deactivated.

For further information, see: [Sun protection](#).

No.	Name	Function of the object	Data type	Flags
25, 65, 105, 145, 185	Output x-y	Sun protection reactivation	1 bit - 1.003 DPT_Enable	C, R, W

This object is activated if the **Deactivate sun protection by local control** parameter is active.
 This object is used to reactivate the sun protection of the device after a lock-up or at the end of a time-limited function, over the KNX Bus.

Object value:

- If the object receives the value 1, the sun protection is reactivated.
- If the object receives the value 0, the sun protection is permanently deactivated.

For further information, see: [Sun protection](#).

No.	Name	Function of the object	Data type	Flags
26, 66, 106, 146, 186	Output x-y	Sun protection status	1 bit - 1.011 DPT_State	C, R, T

This object is activated when the **Sun protection status object** parameter is active.

This object allows the status of the sun protection to be sent over the KNX bus.

Object value: Depends on the **Polarity** parameter.

0 = Authorized, 1 = Locked-up

- If the sun protection is deactivated, a telegram with logic value 1 is sent on the KNX bus.
- If the sun protection is activated, a telegram with logic value 0 is sent on the KNX bus.

0 = Locked-up, 1 = Authorized

- If the sun protection is activated, a telegram with logic value 1 is sent on the KNX bus.
- If the sun protection is deactivated, a telegram with logic value 0 is sent on the KNX bus.

This object is sent periodically and/or on status change.

For further information, see: [Sun protection](#).

5. Appendix

5.1 Specifications

TYA604A/B/C/D

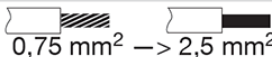
Supply voltage	30 V DC SELV
Power dissipation	1 W (4x4A), 3 W (4x10A), 8 W (4x16A)
Typical consumption on the KNX bus	4 mA
Standby consumption on the KNX bus	3,3 mA
Dimensions	4 x 17,5 mm
Operating temperature	-5 °C → + 45 °C
Storage temperature	-20 °C → + 70 °C
Electrical connection	 0,75 mm ² → 2,5 mm ²
Breaking capacity	μ230V~ 4A AC1 (TYA604A) μ230V~ 10A AC1 (TYA604B) μ230V~ 16A AC1 (TYA604C/D)
Maximum permissible current per device (sum C1...C4)	max. 16 A (TYA604A), max. 30 A (TYA604B), max. 45 A (TYA604C/D)
Maximum switching rate at full load	6 switching cycles/minute
Installation mode	DIN rail
Operating altitude	< 2000 m
Pollution level	2
Surge voltage	4 kV
Protection rating	IP 20 (housing) / IP30 (housing under faceplate)
IK	04
Overvoltage category	III
Standard	EN50491-3 ; EN60669-2-1

TYA608A/B/C/D

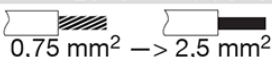



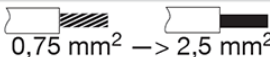

Supply voltage	30 V DC SELV
Power dissipation	2 W (8x4A), 6 W (8x10A), 12 W (6x16A)
Typical consumption on the KNX bus	15,2 mA
Standby consumption on the KNX bus	8,6 mA
Typical consumption KNX bus with the mains	2 mA
Standby consumption KNX bus with the mains	2 mA
Dimensions	6 x 17,5 mm
Operating temperature	-5 °C → + 45 °C
Storage temperature	- 20 °C → + 70 °C
Electrical connection	 0,75 mm ² → 2,5 mm ²
Breaking capacity	μ230V~ 4A AC1 (TYA608A) μ230V~ 10A AC1 (TYA608B) μ230V~ 16A AC1 (TYA608C/D)
Maximum permissible current per device (sum C1...C8)	max. 32A (TYA608A), max. 60A (TYA608B), max. 80A (TYA608C/D)
Maximum switching rate at full load	6 switching cycles/minute
Installation mode	DIN rail
Operating altitude	< 2000 m
Pollution level	2
Surge voltage	4 kV
Protection rating	IP 20 (housing) / IP30 (housing under faceplate)
IK	04
Overvoltage category	III
Standard	EN50491-3 ; EN60669-2-1

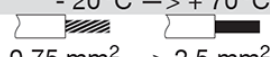
TYA606A/B/C/D

Supply voltage	30 V DC SELV
Power dissipation	1 W (6x4A), 5 W (6x10A), 12 W (6x16A)
Typical consumption on the KNX bus	4,3 mA
Standby consumption on the KNX bus	3,3 mA
Dimensions	4 x 17,5 mm
Operating temperature	-5 °C → + 45 °C
Storage temperature	- 20 °C → + 70 °C
Electrical connection	 0,75 mm ² → 2,5 mm ²
Breaking capacity	μ230V~ 4A AC1 (TYA606A) μ230V~ 10A AC1 (TYA606B) μ230V~ 16A AC1 (TYA606C/D)
Maximum permissible current per device (sum C1...C6)	max.24 A (TYA606A), max. 45 A (TYA606B), max. 60 A (TYA606C/D)
Maximum switching rate at full load	6 switching cycles/minute
Installation mode	DIN rail
Operating altitude	< 2000 m
Pollution level	2
Surge voltage	4 kV
Protection rating	IP 20 (housing) / IP30 (housing under faceplate)
IK	04
Overvoltage category	III
Standard	EN50491-3 ; EN60669-2-1

TYA610A/B/C/D

Supply voltage	30 V DC SELV
Power dissipation	3 W (10x4A) 7 W (6x10A), 15 W (6x16A)
Typical consumption on the KNX bus	15,9 mA
Standby consumption on the KNX bus	7,5 mA
Dimensions	4 x 17,5 mm
Operating temperature	-5 °C → + 45 °C
Storage temperature	- 20 °C → + 70 °C
Electrical connection	 0,75 mm ² → 2,5 mm ²
Breaking capacity	μ230V~ 4A AC1 (TYA610A) μ230V~ 10A AC1 (TYA610B) μ230V~ 16A AC1 (TYA610C/D)
Maximum permissible current per device (sum C1...C10)	max. 16 A (TYA610A), max. 30 A (TYA610B), max. 45 A (TYA610C/D)
Maximum switching rate at full load	6 switching cycles/minute
Installation mode	DIN-rail
Operating altitude	< 2000 m
Pollution level	2
Surge voltage	4 kV
Protection rating	IP 20 (housing) / IP30 (housing under faceplate)
IK	04
Overvoltage category	III
Standard	EN50491-3 ; EN60669-2-1

Load type			TYA604A	TYB604B	TYA604C	TYA604D
			TYA606A	TYB606B	TYA606C	TYA606D
			TYA608A	TYB608B	TYA608C	TYA608D
			TYA610A	TYB610B	TYA610C	TYA610D
	230 V~	Incandescent lamps	800 W	1200 W	2300 W	2300 W
	230 V~	Halogen lamps	800 W	1200 W	2300 W	2300 W
	12V ~ 24V DC	Conventional transformer	800 W	1200 W	1600 W	1600 W
	12V DC 24V DC	Electronic transformer	800 W	1000 W	1200 W	1200 W
	230 V~	Fluorescent tubes non compensated	800 W	1000 W	1200 W	1200 W
		Fluorescent tubes for electronic ballast (mono or duo)	12 x 36 W	15 x 36 W	20 x 36 W	20 x 36 W
		Parallel compensated fluorescent tubes				1500 W 200 µF
	230 V~	Compact fluorescent	6 x 23 W	12 x 23 W	18 x 23 W	18 x 23 W

TYM6xx

Supply voltage KNX	DC 21...32 V SELV
Breaking capacity	μ16A AC1 230V~
Incandescent lamps	2300 W
HV halogen lamps	2300 W
Conventional transformers	1500 VA
Electronic transformers	1500 W
Fluorescent lamps:	
--without ballast	1000 W
--with electronic ballast (mono/duo)	20 x 36 W
--with conv. ballast, parallel circuit	1000 W, 130 μF
Energy-saving/LED lamps	25 x 18 W
Switching current at cos Φ = 0.8 max.	16 A
Minimum switching current 230 V AC	100 mA
Operating altitude max.	2000 m
Degree of contamination	2
Surge voltage	4 kV
Degree of protection of housing	IP20
Degree of protection of housing under front panel	IP30
Impact protection	IK 04
Overvoltage class	III
Operating temperature	-5° ... +45°C
Storage/transport temperature	-20° ... +70°C
Maximum switching cycle rate at full load:	
switching cycle/minute	6
Connection capacity screw terminals:	
rigid	0,5 mm ² ... 6 mm ²
flexible, with conductor sleeve	0,5 mm ² ... 4 mm ²
max. tightening torque	0.5 Nm
Screw print type	PZ1
Standards	EN50491-3 ; EN60669-2-1
Variants 16/8gang	
Power dissipation max.	20 W
Permissible highest current strength per device max.	176 A
Own consumption on the KNX bus:	
--typical	5 mA
--in standby	3 mA
Dimension 8 TE,	8 x 17,5 mm
Variants 20/10gang	
Power dissipation max.	25 W
Permissible highest current strength per device max.	200 A
Own consumption on the KNX bus:	
--typical	5 mA
--in standby	3 mA
Dimension 10 TE,	10 x 17,5 mm

TYB602F

Supply voltage KNX	21...32 V DC SELV
Breaking capacity	μ 6 A AC1 230 V \sim
Switching current at $\cos \Phi = 0.8$ max.	6 A
Minimum switching current	10 mA
Operating altitude max.	2000 m
Degree of contamination	2
Surge voltage	4 kV
Degree of protection of housing	IP20
Impact protection	IK 04
Overvoltage class	III
Operating temperature	-5 °C...+45 °C
Storage/transport temperature	-20 °C ... +70 °C
Maximum switching cycle rate at full load	
switching cycle/minute	20
Connection capacity	0,75 mm ² ...2,5 mm ²
max. tightening torque	0.5 Nm
Cross-head design	PZ1
Standards	EN 50491-3 ; EN 60669-2-1
Dimensions	44 x 43 x 22,5 mm
Own consumption on the KNX bus:	
typical	7 mA
in standby	5 mA
Incandescent lamps	500 W
HV halogen lamps	500 W
Conventional transformer	500 VA
Electronic transformer	500 W
Fluorescent lamps	
--without ballast	500 W
--with electronic ballast	6 x 48 W
Energy-saving lamps/LED lamps	5 x 13 W

5.2 Table of logical operations

Input 4	Input 3	Input 2	Input 1	OR	AND
-	-	0	0	0	0
-	-	0	1	1	0
-	-	1	0	1	0
-	-	1	1	1	1
-	0	0	0	0	0
-	0	0	1	1	0
-	0	1	0	1	0
-	0	1	1	1	0
-	1	0	0	1	0
-	1	0	1	1	0
-	1	1	0	1	0
-	1	1	1	1	1
0	0	0	0	0	0
0	0	0	1	1	0
0	0	1	0	1	0
0	0	1	1	1	0
0	1	0	0	1	0
0	1	0	1	1	0
0	1	1	0	1	0
0	1	1	1	1	0
1	0	0	0	1	0
1	0	0	1	1	0
1	0	1	0	1	0
1	0	1	1	1	0
1	1	0	0	1	0
1	1	0	1	1	0
1	1	1	0	1	0
1	1	1	1	1	1

5.3 Characteristics

Device	TYA604 A/B/C/D	TYA606 A/B/C/D	TYA608 A/B/C/D	TYA610 A/B/C/D	TYM616D	TYM620D	TYB602F
Max. number of group addresses	254	254	254	254	500	500	255
Max. number of allocations	255	255	255	255	500	500	255
Objects	113	153	193	233	353	433	73

