

EN



**TYA6..C**  
Output 16A / shutter/blind

**TYA6..D**  
Output 16A C-Load adapted / shutter/blind

**TXA6..D**  
Output 16A C-Load adapted / shutter/blind



## Safety instructions

EN

Electrical equipment may only be installed and assembled by a qualified electrician in accordance with the relevant installation standards, guidelines, regulations, directives, safety and accident prevention regulations of the country.

Failure to comply with these installation instructions may result in damage to the device, fire or other hazards.

**Hazard due to electric shock. Disconnect before working on the device or load. Take into account all circuit breakers that supply dangerous voltages to the device or load.**

**Hazard due to electric shock. The device is not suited for safe disconnection of the mains supply.**

**Hazard due to electric shock on the SELV/PELV installation. Not suitable for switching SELV/PELV voltages.**

**Do not connect only one motor per output. When connecting several motors, motors or device may be destroyed**

**Use drives with mechanical or electrical final position switches only. Check final position switches for correct adjustment. Observe motor manufacturer's data. The device could get damaged.**

**Do not connect any three-phase motors. The device could get damaged.**

**Observe the motor manufacturer's data regarding change-over time and max. switch-on time.**

**These instructions are an integral component of the product and must be retained by the end user.**

## Function

### System information

This device is a product of KNX system and corresponds to the KNX guidelines. Detailed specialised knowledge obtained from KNX training courses is required for comprehension. The planning, installation and commissioning of the device is carried out with the help of KNX-certified software.

### Systemlink start-up:

The function of the device is software-dependent. The software is to be taken from the product database. You can find the latest version of the product database, technical descriptions as well as conversion and additional support programmes on our website.

### Easylink start-up:

The function of the device is configuration-dependent. The configuration can also be done using devices developed specially for simple setting and start-up.

This type of configuration is only possible with devices of the easylink system. Easylink stands for easy, visually supported start-up. Preconfigured standard functions are assigned to the in/outputs by means of a service module.

### Functional description

The device receives telegrams from sensors or other controllers via the KNX installation bus and switches electrical loads with its independent relay contacts.

The C load variants are particularly suitable for capacitive loads and are designed for high switch-on currents.

### Correct use

- Switch electrical loads of 230 V AC with potential-free contacts.
- Switching electrically operated motors of 230 V AC for blinds, shutters, awnings and similar hangings.
- Mounting on DIN rail according to DIN EN 60715 in the distribution box.

### Product characteristics

- manual activation of the outputs on the device possible, building site operation
- Status display of the outputs on the device
- Scene function
- Forced position by higher-level controller
- Connection of various external conductors possible.

### Functions in switch operation

- Time switching functions

### Functions in shutter/blind operation:

- Position can be started directly
- Slat position directly controllable
- Feedback of operating state, shutter position and slat adjustment
- 3 Alarms

## Operation

### Manual operation switch on/off

With the 8/4gang variants, control of the outputs is possible even without bus voltage when mains voltage is connected e.g. for operation at building sites.

Bus or mains power supply is present.

- Push switch (1) to position

Manual operation is switched on, the outputs can be controlled using the operation buttons (6) independently of each other.

## Design and layout of the device

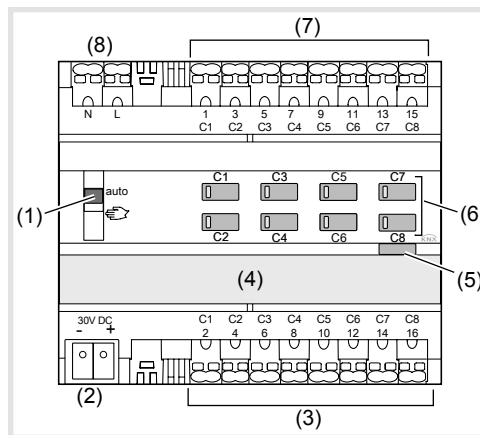

Fig. 1: Example device variant 8/4gang

- (1) Slide switch **auto**
- (2) KNX bus connection terminal
- (3) Connections loads
- (4) Labelling field
- (5) Illuminated programming button
- (6) Operation button for manual operation per output with status LED
- (7) Connections for switching voltage
- (8) Mains power supply connections (only 8gang)

With variants 4/2gang, 6/3gang and 10/5gang the basic design corresponds to the 8/4gang device variant.

**I** During manual operation, the controller is deactivated via the KNX bus.

**I** Systemlink start-up  
Depending on the programming, the manual operation is either activated permanently or for a time period configured via the application software. If the manual operation is blocked via the application software, no activation takes place.

Or:

- Move switch (1) to position **auto**.

The manual operation is switched off. Operation takes place solely via the KNX bus. The output adopts the position predefined by the bus controller.

### Operating outputs in manual operation

Operation takes place per output by brief repeated presses on the operation button (table 1).



#### CAUTION!

**Risk of destruction due to simultaneous pressing of the buttons for UP and DOWN if a motor is connected when the motor is in unprogrammed state!**

**Motors, hangings and the device may be destroyed!**

**Always only press one button in manual operation for unprogrammed devices.**

Status	Behaviour when button pressed briefly
Switching operation	
Load is switched off. Status LED of the button (6) is off	Switch ON the connected load. Status LED of the button (6) lights up.
Load is switched on, status LED of the button (6) lights up	Switch OFF the connected load. LED goes out.
Roller shutter/blind operation	
Output is in standby, status LED of the button (6) is off	Movement operation starts. Status LED of the button (6) lights up. <sup>1)</sup> <b>I</b> If the roller shutter/blind is in the final position, press the opposite button to move the roller shutter/ blind
Output active, status LED of the button (6) lights up. <sup>1)</sup>	Movement operation stops, LED goes out.

<sup>1)</sup> LED lights up red with TYA6.. devices. LED lights up red while moving up and green while moving down with TXA6.. devices

Table 1: Manual operation

## Information for electricians

### Installation and electrical connection



#### DANGER!

**Touching live parts can result in an electric shock!**

**An electric shock can be lethal!**

**Disconnect the connecting cables before working on the device and cover all live parts in the area!**



#### CAUTION!

**Impermissible heating if the load of the device is too high!**

**The device and the connected cables may get damaged in the connection area!**

**Do not exceed the maximum current carrying capacity!**



#### CAUTION!

**Risk of destruction if parallel connection of several motors on one output!**

**Final position switches could fuse together. Motors, hangings and the device may be destroyed!**

**Do connect only one motor per output!**

### Installing the appliance

**I** Observe temperature range. Provide sufficient cooling.

- Mount device onto DIN rail in accordance with DIN EN 60715.

### Connect device

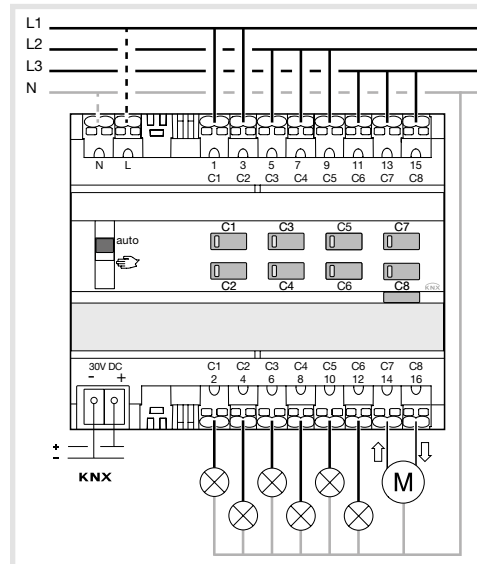

Fig 2: Device connection

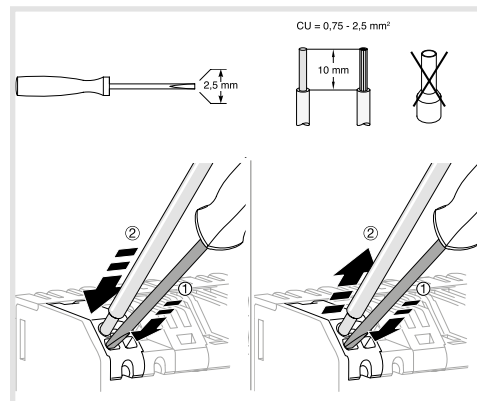
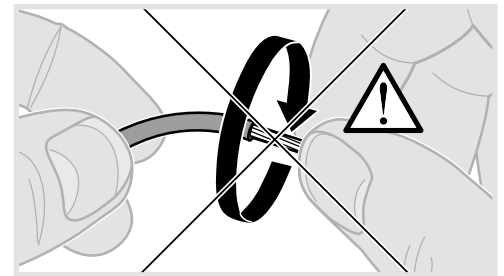

Fig 3: Installation/deinstallation with plug-in terminals



- Connect bus cable via connecting terminal (2).

**I** Mains voltage can be connected optionally for device variants 8/4gang (8). Reduction of the power supply load is possible (see Technical data).

### Connecting loads to be switched

The output is configured as switching output.

- Connect switching voltage on the upper terminal strip (7) of the device
- Connect load on the lower terminal strip (3) of the device

### Connecting blind drives

The two adjacent relay outputs **C1/C2, C3/C4, C5/C6, C7/C8** each form one blind output for blind operations. Each left relay output **C1, C3, C5, C7** is intended for the direction UP, each right relay output **C2, C4, C6, C8** is intended for the direction DOWN. In manual operation, the blind is moved UP and DOWN using the corresponding operation buttons.

Two outputs are configured as blind output.

- Connect supply voltage of the drives on the upper terminal strip (7). While doing so, use the same phase (external conductors).
- Connect drives on the lower terminal strip (3).

## Start-up

### Systemlik: Loading the physical address and application software

The switch (1) is in position **auto**.

- Switch on bus voltage.
- Press programming button (5).  
The button lights up.

**I** If the button does not light up, no bus voltage is present.

- Load the physical address into the device.  
Status LED of the button goes out.
- Load application software.
- Note down the physical address on the labelling field (4).

### Easylink:

Information on the system configuration can be taken from the extensive description of the service module easylink.

### Start up the device.

- Switch on mains voltage on the outputs.
- Switch on mains supply (variant 8gang).

### Determine operation time and slat adjusting time

In blind/roller shutter operation, the operation time for positioning the sunshade is important. The position is calculated based on the operation time. The slat adjusting time for slat blinds, determined by

the design, is part of the total operation time. The opening angle of the slats is therefore set as operation time between opened and closed position.

**I** The operation time for UP is normally longer than the operation time for DOWN and must be measured separately if necessary

- Measure UP and DOWN operation time of the hanging.
- Measure slat adjusting time between OPEN and CLOSED.
- Enter measured values into the parameter setting – **running time...** or **slat step time**.

### Functional test

The functionality of the outputs is displayed via the status LED of the operation button (6).

## Appendix

### Technical data

Supply voltage KNX	21-32V $\overline{\text{=}}$ TBTS
Breaking capacity	$\mu$ 16AAC1 230V~
Incandescent lamps	2300 W
HV halogen lamps	2300 W
Conventional transformers	1600 W
Electronic transformers	1200 W
Fluorescent lamps:	
- without ballast	1200 W
- with electronic ballast (mono/duo)	20 x 36 W
Energy-saving lamps	18 x 23 W
Switching current at $\cos \Phi = 0.6$	max. 6 A
Upstream protection: circuit breaker	16 A
Minimum switching current	100 mA
Interlock time for changing direction of travel	software-dependent
Operating altitude	max. 2000 m
Degree of contamination	2
Surge voltage	4 kV
Degree of protection of housing	IP 20
Degree of protection of housing under front panel	IP30
Impact protection	IK 04
Overvoltage class	III
Operating temperature	-5° ... +45°C
Storage/transport temperature	-20 ... +70 °C
Maximum switching cycle rate at full load	6 switching cycle/minute
Connection capacity	0.75 mm <sup>2</sup> ...2.5 mm <sup>2</sup>
Communication media KNX	TP 1
Configuration mode	S-Mode, Easy link controller (TXA ... only)

### Only C load variants

Fluorescent lamps with conv. ballast, parallel connection	1500 W, 200 $\mu$ F
---	---------------------

### Variants 4/2gang

Energy dissipation	8 W
Maximum current permitted per device	max. 40 A
Own consumption on the KNX bus:	
- typical	4 mA (TYA..) 5 mA (TXA..)
- in standby	3,3 mA (TYA..) 3 mA (TXA..)
Dimension	4 TE, 4 x 17.5 mm

### Variants 6/3gang

Energy dissipation	12 W
Maximum current permitted per device	max. 60 A
Own consumption on the KNX bus:	
- typical	4,3 mA (TYA..) 5 mA (TXA..)
- in standby	3,3 mA (TYA..) 3 mA (TXA..)
Dimension	4 TE, 4 x 17.5 mm

### Variants 8/4gang

Auxiliary voltage	230V~ +10/-15% 240V~ +/-6%
Maximum current permitted per device	max. 80 A
Energy dissipation	12 W
Own consumption on the KNX bus:	
- typical	15,2 (TYA..) 6 mA (TXA..)
- in standby	8,6 mA (TYA..) 4 mA (TXA..)
Own consumption on the KNX bus with mains connection:	
- typical	2 mA (TXA..., TYA..)
- in standby	2 mA (TXA..., TYA..)
Dimension	6 TE, 6 x 17.5 mm

### Variants 10/5gang

Energy dissipation	15 W
Maximum current permitted per device	max. 100 A
Own consumption on the KNX bus:	
- typical	15,9 mA (TYA..) 6 mA (TXA..)
- in standby	7,5 mA (TYA..) 4 mA (TXA..)
Dimension	6 TE, 6 x 17.5 mm

## Troubleshooting

### Manual operation not possible

Cause 1: Switch (1) not moved to .

Move switch to .

Cause 2: Manual operation is not enabled (Systemlink).

Enable manual operation via application software.

### Bus operation is not possible

Cause 1: Bus voltage is not present.

Check bus connection terminals for correct polarity.

Check bus voltage by briefly pressing the programming button (5), red LED lights up if bus voltage is present.

8gang: If mains voltage without bus voltage is present - red LED of programming button (5) flashes.

Cause 2 : Manual operation is active. Switch (1) is in position .

Move switch (1) to position **auto**.

### Shutters/blinds do not move to the final position

Cause: Operation time for the shutters/blinds set incorrectly.

Check operation times. Measure again and reprogram if necessary.

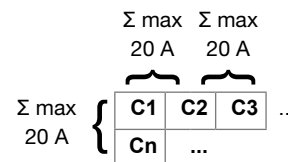

Overall load current rating of neighbouring outputs 20 A



Correct Disposal of This product (Waste Electrical & Electronic Equipment).

(Applicable in the European Union and other European countries with separate collection systems).

This marking shown on the product or its literature indicates that it should not be disposed with other household waste at the end of its working life. To prevent possible harm to the environment or human health from uncontrolled waste disposal, please separate this from other types of wastes and recycle it responsibly to promote the sustainable reuse of material resources.

Household users should contact either the retailer where they purchased this product, or their local government office, for details of where and how they can take this item for environmentally safe recycling.

Business users should contact their supplier and check the terms and conditions of the purchase contract. This product should not be mixed with other commercial wastes of disposal.

Usable in all Europe  and in Switzerland