







Tebis application software

- ▲ Manufactures
- ▲ Hager Electro
- ▲ Outputs
 - 6-output modules

6-fold switch actuator 16A 230V current monitoring

Electrical/Mechanical characteristics: See product user manual

	Product reference	Product designation	Application software ref	TP device  Radio device 
	TYA606E	6-fold switch actuator 16A 230V current monitoring	STYA606E 1.x Version	

Content

1. General	4
1.1 About this guide	4
1.2 About the program	4
1.2.1 ETS compatibility	4
1.2.2 Application descriptions	4
2. General Description	5
2.1 Installation of the device	5
2.1.1 Overview presentation	5
2.1.2 Connection	6
2.1.3 Physical addressing	6
2.2 Function modules of the application	7
2.2.1 Primary functions	7
2.2.2 Additional functions	9
3. Parameters	10
3.1 Definition of the general parameters	10
3.1.1 Manual mode	10
3.1.2 Activation of the Status indication	10
3.1.3 Activation of the logic blocks	11
3.1.4 Activation of the Device diagnosis object	11
3.1.5 Restore ETS-Parameters	11
3.1.6 Status during bus power cut or download	12
3.1.7 LED display	13
3.2 Manual mode	14
3.2.1 Duration of manual mode activation	14
3.2.2 Deactivation of manual mode	14
3.2.3 Status indication manual mode	15
3.2.4 Status after manual mode	16
3.3 Status indication	17
3.4 Logic block	19
3.4.1 Configuration of the Logic function	20
3.4.2 Logic block authorization	21
3.4.3 Logic result	23
3.5 Diagnosis	26
3.6 Function selection	28
3.6.1 Definition	28
3.6.2 ON/OFF timings function	33
3.6.2.1 Delays for ON/OFF objects	33
3.6.2.2 Timer/toggle switch changeover for ON/OFF object	35
3.6.2.3 Time limited toggle switch	36
3.6.3 Timer	37
3.6.3.1 Timer operation	37
3.6.3.2 Cut-OFF pre-warning	38
3.6.3.3 Configuration	38
3.6.4 Scene	40
3.6.5 Preset	43
3.6.6 Lock-up	47
3.6.7 Priority	51
3.6.8 Hours counter	53
3.6.9 Current detection	56
3.6.9.1 Output current detection delay after switching	56
3.6.9.2 Switching validation via current measurement	57
3.6.9.3 Current setpoint monitoring	59
3.6.9.4 No current flow detection	64
3.6.9.5 Switching counter	66
3.6.9.6 Emission current value	70
3.6.9.7 Current det. in open contacts	72
4. Communication objects	74
4.1 Communication objects General	74
4.1.1 Manual mode	74
4.1.2 Logic block	75
4.1.3 Behaviour of the device	76
4.1.4 Diagnosis	77

4.2 Output communication objects	78
4.2.1 ON/OFF	84
4.2.2 ON/OFF timings function	84
4.2.3 Status indication	85
4.2.4 Timer	85
4.2.5 Scene	86
4.2.6 Preset	87
4.2.7 Lock-up	88
4.2.8 Priority	89
4.2.9 Hours counter	90
4.2.10 Current detection	91
5. Appendix	96
5.1 Specifications	96
5.2 Table of logical operations	97
5.3 Characteristics	97

1. General

1.1 About this guide

The purpose of this manual is to describe the operation and configuration of the KNX-devices using the ETS program. It consists of 4 parts:

- General information.
- Parameter description.
- Overview of KNX objects.
- Technical characteristics.

1.2 About the program

1.2.1 ETS compatibility

The application programs are compatible with ETS4 and ETS3. They can be downloaded from our website under the order number.

ETS Version	File extension of compatible files
ETS4	*.knxprod or *.vd5
ETS3 (V3.0f)	*.vd5

1.2.2 Application descriptions

Application	Product reference
STYA606E	TYA606E

2. General Description

2.1 Installation of the device

2.1.1 Overview presentation

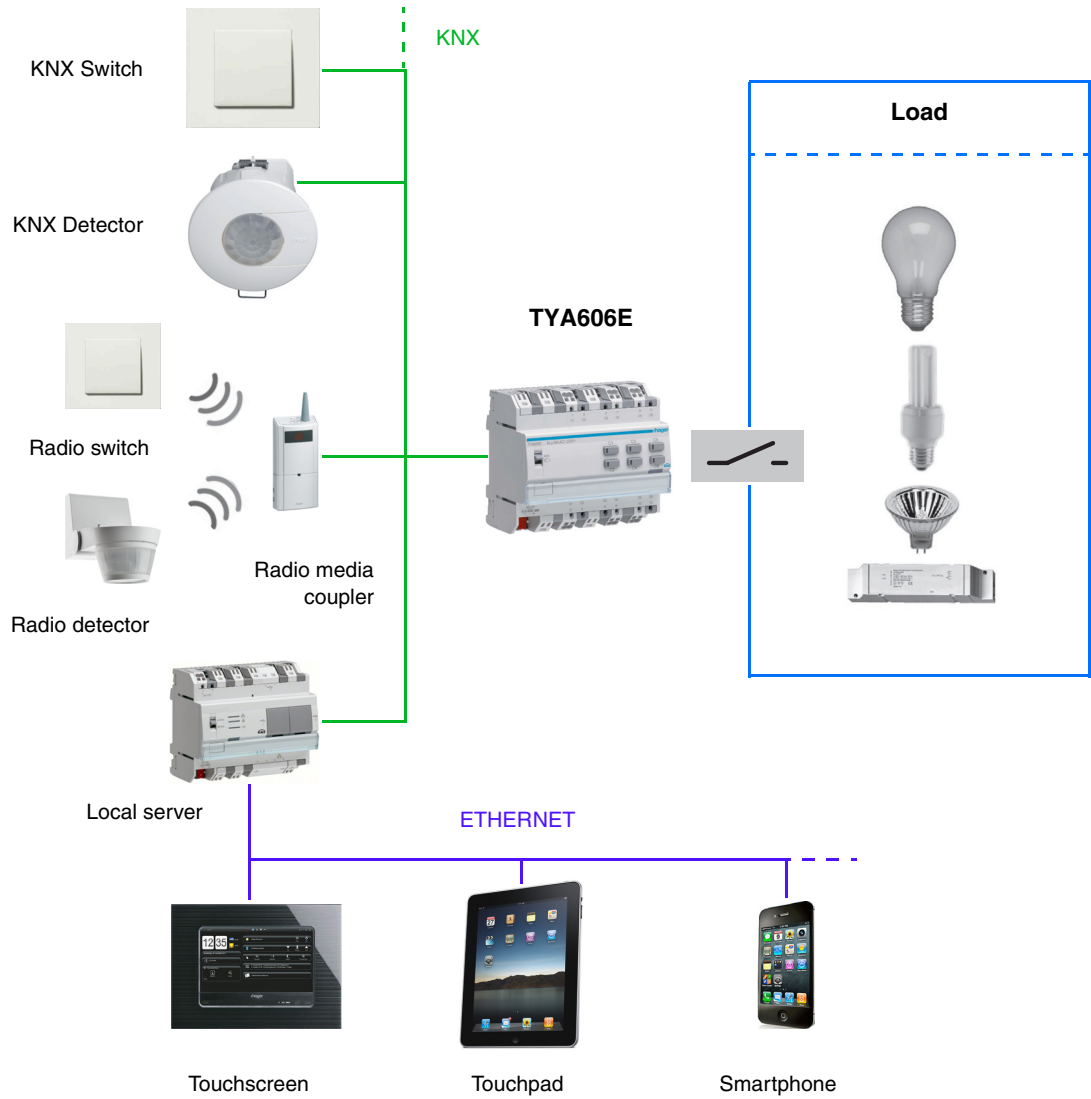

2.1.2 Connection

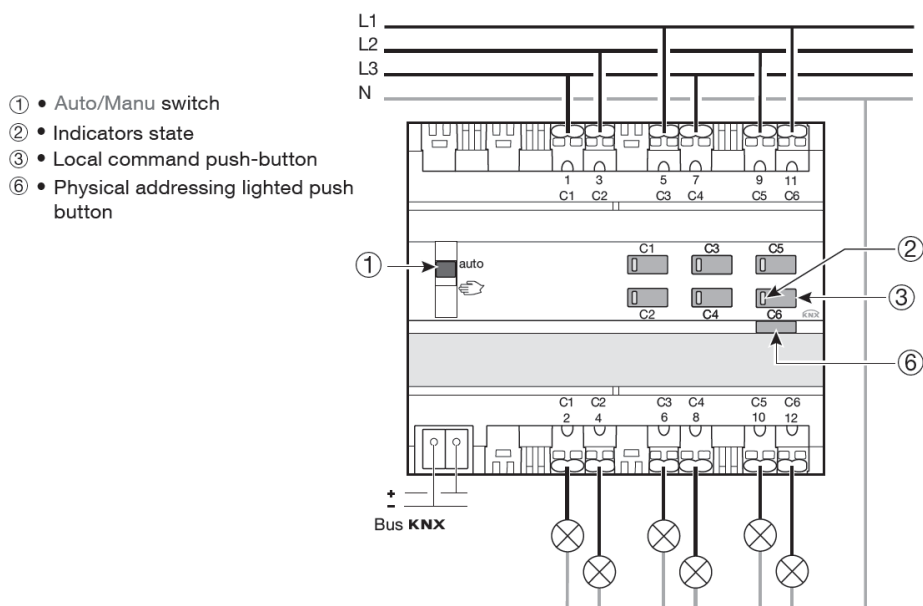

The outputs can be connected to different phases.

2.1.3 Physical addressing

In order to perform the physical addressing or to check whether or not the bus is connected, press the lighted push button (6) on the right-hand side above the identification plates on the front of the device.

Light on = bus connected and ready for physical addressing.

Programming mode is activated, until the physical address is transferred from ETS. Pressing the button again, exits programming mode. Physical addressing can be carried out in automatic or manual mode.

2.2 Function modules of the application

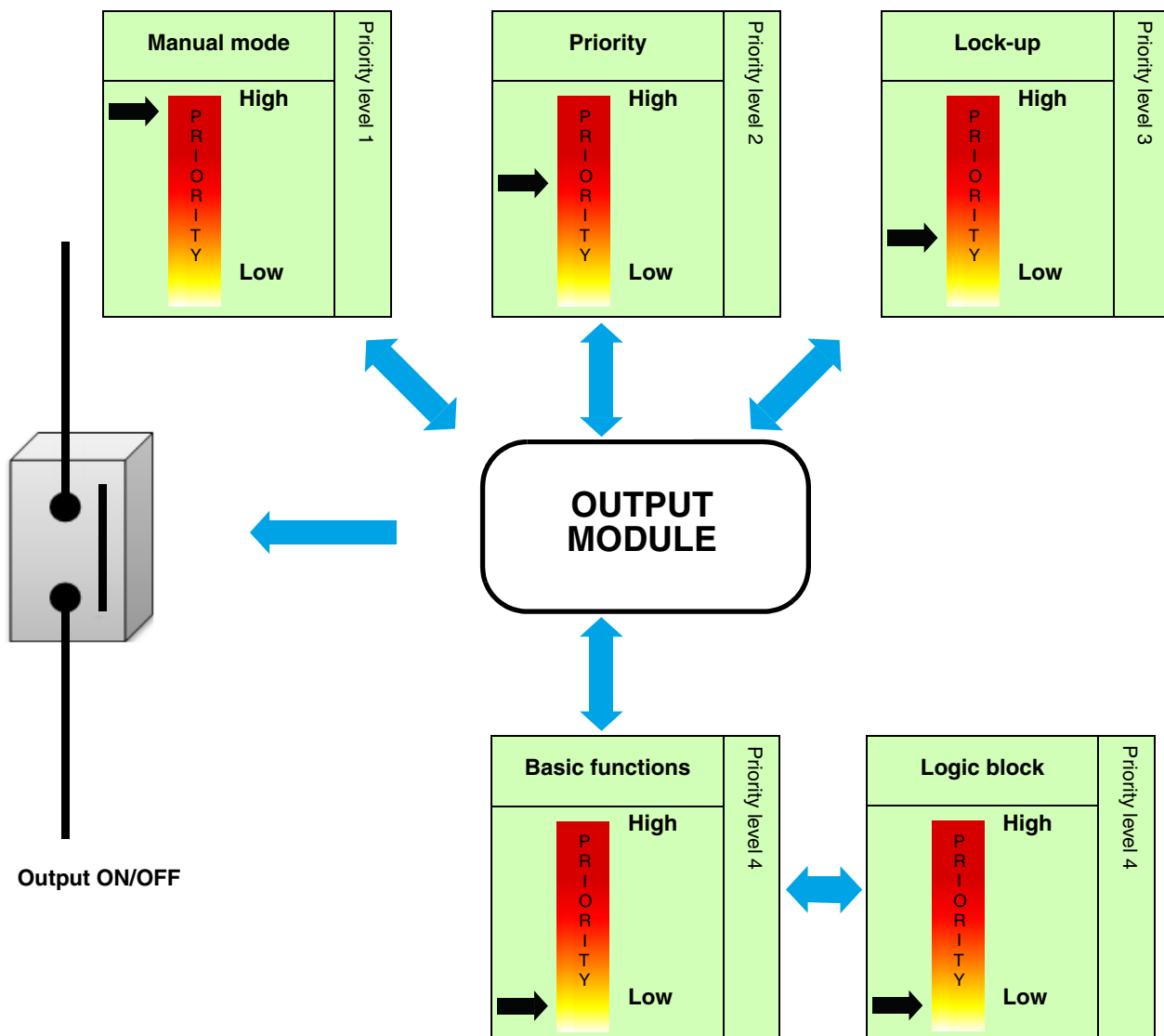

2.2.1 Primary functions

The applications allow individual configuration of the device outputs. The most important functions are:

■ ON/OFF

An output can be switched on or off using the ON/OFF function. The command can come from switches, buttons or other control inputs.

■ Timer

The Timer function is used to switch an output on or off for a programmable period. According to the selected operating mode of the timer, the output can be turned ON or OFF for a determined period of time. The timer may be interrupted before expiry of the delay time. A programmable Cut-OFF pre-warning announces the end of the delay time by a 1-second inversion of the output status. The timer duration can be modified via the bus KNX.

■ Time limited toggle switch

The Time-limited OFF function is a switching function that automatically switches off after a configurable delay time. Application: Lighting of store rooms, cellars, sheds etc.

■ Priority

The Priority function is used to force the output into a defined state. The Priority function is controlled with a 2-bit command.

Priority: Manual mode > **Priority** > Lock-up > Basic function.

Only a Priority OFF command authorizes the output for control.

Application: Keeping lighting on for security reasons.

■ Lock-up

The Lock-up function is used to lock the output in a predefined state.

Priority: Manual mode > Priority > **Lock-up** > Basic function.

The Lock-up prevents actuation until an unlock command has been received. The Lock-up duration can be set.

■ Scene

The Scene function is used to switch groups of outputs into a configurable predefined state. A scene is activated by receipt of a 1-byte command. Each output can be included in 64 different scenes.

■ Preset

The Preset function is used to switch an output into various predefined states. The Preset function is activated via an object in 1-bit format. Each output can be controlled via 2 Preset objects.

■ Delay

The Delay functions are used to activate the outputs with a switching or tripping delay or with a switching and tripping delay.

■ Timer/toggle switch changeover

The Timer/toggle switch changeover function is used to switch between a Timer and a Toggle switch function applied to the communication object ON/OFF.

■ Hours counter

The Hours Counter function is used to count the overall operating time of an output in the ON or OFF state. The counter setpoint can be programmed and altered via an object.

■ Current detection

The following applications, for example, can be covered by the Current detection function:

- Visualization of effective currents.
- Monitoring of power consumption setpoints.
- Error detection.

This information is sent periodically and/or on a change of status.

2.2.2 Additional functions

The applications configure the general functions of the devices. The following functions apply to the entire device:

■ Manual mode

Manual mode allows the device to be disconnected from the bus. In this mode, each output can be priority controlled locally. This command has the highest priority. No other command is considered when manual mode is active. Only after ending manual mode are other types of control again permitted. The duration of the manual control can be configured. Manual mode can be locked-up via the KNX bus.

■ Status indication

The behaviour of the status indication of each switching channel can be configured for the entire device. The Status indication sends the switching status of the individual output contact on the KNX bus.

■ Logic block

The Logic function is used to control an output depending on the result of a logic operation. This command has the lowest priority. The result of the function can be output on the KNX bus and can directly control one or more outputs. There are 2 logic blocks per device with up to 4 inputs available.

■ Diagnosis

The Device diagnosis function allows notifications about the operating state of the device to be sent via the KNX bus. This information is sent periodically and/or on status change.

3. Parameters

3.1 Definition of the general parameters

This configuration window is used for general configuration of the device.

Device: 1.1.1 6-fold switch actuator 16A 230V current monitoring

Outputs 1-6: General

- O1-6: Manual mode
- O1-6: Status indications
- Output 1: Function selection
- Output 2: Function selection
- Output 3: Function selection
- Output 4: Function selection
- Output 5: Function selection
- Output 6: Function selection
- Information

Manual mode	Active
Status indication	Active
Logic block 1	Not active
Logic block 2	Not active
Device diagnosis object	Not active
Activ. of restore ETS-parameters object (scenes, timer, setpoints)	Not active
Parameters overwrite at next download (scenes)	Active
Status during bus power cut	Maintain status
Status at bus return	Maintain status
Status after ETS download	Maintain status
Device LED switch off object	Active
Polarity	0 = Status indication, 1 = Always OFF

3.1.1 Manual mode

Parameter	Description	Value
Manual mode	Switching to manual mode is not possible.	Not active
	Switching to manual mode is possible without time limit.	Active*
	Manual mode can be activated for a duration that is configurable via the ETS parameters. After expiry of the time limit, manual mode is no longer active.	Time limited

For configuration see section: [Manual mode](#).

3.1.2 Activation of the Status indication

Parameter	Description	Value
Status indication	The Status indications parameter register is hidden.	Not active
	The Status indications parameter register is displayed.	Active*

For configuration see section: [Status indication](#).

* Default value

3.1.3 Activation of the logic blocks

Parameter	Description	Value
Logic block 1	Communication object and parameter register Logic block 1 are hidden.	Not active*
	Communication object and parameter register Logic block 1 are displayed.	Active

For configuration see section: [Logic block](#).

Note: The parameters and objects are identical for block 2 ; Only the terms will be adjusted.

For logic block 1

Communication objects: **195 - Logic block 1 - input 1** (1 bit - 1.002 DPT_Bool)
 199 - Logic block 1 - Logic result (1 bit - 1.002 DPT_Bool)

For logic block 2

Communication objects: **201 - Logic block 2 - input 1** (1 bit - 1.002 DPT_Bool)
 205 - Logic block 2 - Logic result (1 bit - 1.002 DPT_Bool)

3.1.4 Activation of the Device diagnosis object

Parameter	Description	Value
Device diagnosis object	The Device diagnosis parameter register and the associated communication object is hidden.	Not active*
	The Device diagnosis parameter register and the associated communication object are displayed.	Active

Communication object: **208 - Outputs 1-6 - Diagnosis** (6 byte - Specific)

For configuration see section: [Diagnosis](#).

3.1.5 Restore ETS-Parameters

There are 2 types of parameters in the device:

- Parameters that can only be changed via ETS.
- Parameters that can be changed via ETS or via the KNX bus.

For parameters that can be changed via ETS and via the KNX bus, 2 values are stored in the device memory: The value corresponding to the ETS-parameter and the currently used value.

* Default value

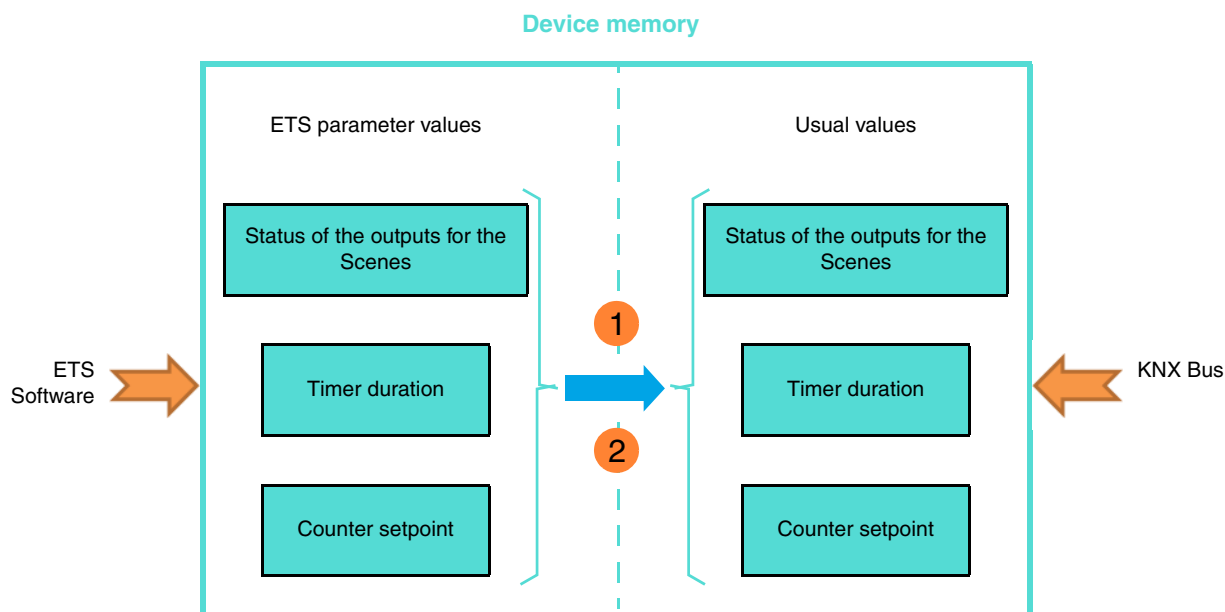

- 1 Receipt of the value 1 on the object, Resets the ETS parameter values: Current parameter values are replaced by the ETS-parameter values.
- 2 Download of the ETS application: Current parameter values are replaced by the ETS parameter values on download.

Parameter	Description	Value
Activ. of restore ETS-parameters object (scenes, timer, setpoints)	The Restore ETS-params settings communication object is hidden.	Not active*
	The Restore ETS-params settings communication object is displayed.	Active
	On receipt of a 1 on this object, the parameters** that are adjustable via the bus are overwritten with values set in the ETS before the last download.	

** Output status for scene X, Timer duration, Hours counter setpoint, Current setpoint 1 and 2, Counter value setpoint.

Communication object: [206 - Outputs 1-6 - Restore ETS-params settings \(1 bit - 1.015 DPT_Reset\)](#)

Parameter	Description	Value
Parameters overwrite at next download (scenes)	The parameter values stored in the device will remain in the device at the next download.	Not active
	The parameter values stored in the device will be overwritten with the ETS configured values at the next download.	Active*

3.1.6 Status during bus power cut or download

Parameter	Description	Value
Status during bus power cut	The output status remains unchanged during a bus power cut.	Maintain status*
	The output is turned on when there is a bus power cut.	ON
	The output is turned off when there is a bus power cut.	OFF

* Default value

Parameter	Description	Value
Status at bus return	The output status remains unchanged during at bus return.	Maintain status*
	The output is switched on at bus return.	ON
	The output is switched off at bus return.	OFF

Note: The device will reboot on bus return. The Priority functions that were present before the bus power cut, are no longer active (Priority, Lock-up).

Parameter	Description	Value
Status after ETS download	The output status remains unchanged after ETS download.	Maintain status*
	The output is switched on after ETS download.	ON
	The output is switched off after ETS download.	OFF

Note: During ETS-parameters download, the outputs remain unchanged.

3.1.7 LED display

Parameter	Description	Value
Device LED switch off object	The Device LEDs lock-up communication object is hidden.	Not active*
	The Device LEDs lock-up communication object is displayed.	Active

This function is used to reduce the overall power consumption of the device. It allows the LEDs on the front of the device to be switched off.

Communication object: [207 - Outputs 1-6 - Device LED switch off \(1 bit - 1.001 DPT_Switch\)](#)

Parameter	Description	Value
Polarity	Object Device LED lock receives: 0 = The LED display is activated 1 = The LED display is deactivated 0 = The LED display is deactivated 1 = The LED display is activated	0 = Status indication, 1 = Always OFF* 0 = Always OFF, 1 = Status indication

*Note: This parameter is only visible if the parameter **Device LED switch off object** has the following value: **Active**.*

* Default value

3.2 Manual mode

In manual mode the device is disconnected from the KNX bus.

The function of the connected load can be checked using the manual mode button. Manual mode can only be activated using the switch on the front of the device. In this mode, telegrams arriving from the KNX bus are ignored.

When manual mode is activated, the status of the relays initially remains unchanged. Each time the manual mode button of an output is pressed, its status is switched over.

The behaviour is determined by the following parameters:

Device: 1.1.1 6-fold switch actuator 16A 230V current monitoring

Outputs 1-6: General

- O1-6: Manual mode
- O1-6: Status indications
- Output 1: Function selection
- Output 2: Function selection
- Output 3: Function selection
- Output 4: Function selection
- Output 5: Function selection
- Output 6: Function selection
- Information

Duration of manual mode activation (h): 0

Duration of manual mode activation (min): 30

Duration of manual mode activation (s): 0

Object deactivation of manual mode: Active

Polarity: 0=Manual mode authorized, 1=Manual mode locked-t

Object status indication manual mode: Active

Polarity: 0=Manual mode deactivated, 1=Manual mode activat

Emission: On status change

Status after manual mode: Maintain status

3.2.1 Duration of manual mode activation

Parameter	Description	Value
Duration of manual mode activation	This parameter defines the amount of time for which manual mode remains activated.	0 hours: 0 to 23 h 30 minutes: 0 to 59 min 0 seconds: 0 to 59 s

Note: The smallest executable time is 1 second.

*Note: This parameter is only visible if the **Manual mode** parameter has the following value: **Time limited**.*

3.2.2 Deactivation of manual mode

Parameter	Description	Value
Object deactivation of manual mode	The Deactivation of manual mode communication object is hidden.	Not active*
	The Deactivation of manual mode communication object is displayed.	Active

Communication object: [192 - Outputs 1-6 - Deactivation of manual mode \(1 bit - 1.001 DPT_Switch\)](#)

* Default value

Parameter	Description	Value
Polarity	The Deactivate manual mode object receives: 0 = Manual mode is activated 1 = Manual mode is not activated 0 = Manual mode is not activated 1 = Manual mode is activated	0 = Manual mode authorized, 1 = Manual mode locked-up* 0 = Manual mode locked-up, 1 = Manual mode authorized

Note: This parameter is only visible if the **Object deactivation of manual mode** parameter has the following value: **Active**.

3.2.3 Status indication manual mode

Parameter	Description	Value
Object status indication manual mode	The Status indication manual mode communication object is hidden. The Status indication manual mode communication object is displayed.	Not active* Active

Communication object: [193 - Outputs 1-6 - Status indication manual mode \(1 bit - 1.011 DPT_State\)](#)

Parameter	Description	Value
Polarity	The Status indication manual mode communication object sends: 0 = When manual mode is switched on 1 = When manual mode is switched off 0 = When manual mode is switched off 1 = When manual mode is switched on	0 = Manual mode active, 1 = Manual mode not active 0 = Manual mode not active, 1 = Manual mode active*

Note: This parameter is only visible if the **Object status indication manual mode** parameter has the following value: **Active**.

Parameter	Description	Value
Emission	The Status indication manual mode communication object is sent: On switching manual mode on or off. Periodically after a configurable time. On switching manual mode on or off and periodically after a configurable time.	On status change* Periodically On status change and periodically

Note: This parameter is only visible if the **Object status indication manual mode** parameter has the following value: **Active**.

Parameter	Description	Value
Hours (h)	This parameter determines the time between the individual transmissions of the Status indication manual mode object.	0 hours: 0 to 23 h
Minutes (min)		30 minutes: 0 to 59 min
Seconds (s)		0 seconds: 0 to 59 s

Note: This parameter is only visible if the **Emission** parameter has the following value: **Periodically** or **On status change and periodically**.

* Default value

3.2.4 Status after manual mode

Parameter	Description	Value
Status after manual mode	<p>At the end of manual mode, the output status is:</p> <p>Not changed.</p> <p>Is switched to the opposite status.</p> <p>Selectively switched on.</p> <p>Selectively switched off.</p> <p>Switched back to the status before manual mode was activated.</p> <p>Switched to the status which would be active according to other communication objects if the manual mode had not taken place.</p>	<p>Maintain status*</p> <p>Inversion</p> <p>ON</p> <p>OFF</p> <p>Status before manual mode</p> <p>Theoretical status without manual mode</p>

Note: The application of this parameter depends on the priority of the other active functions. If a function with higher priority is active, this parameter will not be enacted. In the case where two functions with the same priority are active, the parameter of the most recently switched off function is enacted.

* Default value

3.3 Status indication

The status Indication function specifies the status of the output contact.

Device: 1.1.1 6-fold switch actuator 16A 230V current monitoring

Outputs 1-6: General

- O1-6: Manual mode
- O1-6: Status indications
- Output 1: Function selection
- Output 2: Function selection
- Output 3: Function selection
- Output 4: Function selection
- Output 5: Function selection
- Output 6: Function selection
- Information

Polarity	0 = OFF, 1 = ON	▼
Emission during manual mode	Active	▼
Emission	On status change and periodically	▼
Hours (h)	0	▲▼
Minutes (min)	10	▲▼
Seconds (s)	0	▲▼
Emission after bus power return (h)	0	▲▼
Emission after bus power return (min)	0	▲▼
Emission after bus power return (s)	20	▲▼

Parameter	Description	Value
Polarity	<p>The Status indication ON/OFF communication object sends:</p> <p>0 = For an open output contact 1 = For a closed output contact</p> <p>0 = For a closed output contact 1 = For an open output contact</p>	<p>0 = OFF, 1 = ON*</p> <p>0 = ON, 1 = OFF</p>

*Note: If the Blinking function is activated, the above parameter is ignored and replaced by the **Output status during Blinking function** parameter.*

Parameter	Description	Value
Emission during manual mode	<p>The Status indication ON/OFF communication object sends:</p> <p>Values if the output status is switched in manual mode.</p> <p>No values if the output status is switched in manual mode.</p>	<p>Active*</p> <p>Not active</p>

Parameter	Description	Value
Emission	<p>The Status indication ON/OFF communication object is sent:</p> <p>On each output change.</p> <p>Periodically after a configurable time.</p> <p>On output change and periodically after a configurable time.</p>	<p>On status change*</p> <p>Periodically</p> <p>On status change and periodically</p>

* Default value

Parameter	Description	Value
Hours (h)	This parameter determines the time between the individual transmissions of the Status indication ON/OFF object.	0 hours: 0 to 23 h
Minutes (min)		10 minutes: 0 to 59 min
Seconds (s)		0 seconds: 0 to 59 s

Note: The smallest executable time is 1 second.

*Note: This parameter is only visible if the **Emission** parameter has the following value: **Periodically** or **On status change and periodically**.*

Parameter	Description	Value
Emission after bus power return	This parameter determines the delay for emission of the Status indication ON/OFF object on return of the KNX bus after a power cut.	0 hours: 0 to 23 h 0 minutes: 0 to 59 min 20 seconds: 0 to 59 s

Note: The smallest executable time is 1 second.

Note: This parameter can be used to optimize the bus load after the return of the KNX bus voltage.

* Default value

3.4 Logic block

The Logic function is used to control an output depending on the result of a logic operation. This command has the lowest priority. The result of the function can be output on the KNX bus and may directly relate to the status of one or more outputs. 2 logic blocks are available for each device.

The behaviour is determined by the following parameters:

Note: The description of the parameters is given for logic block 1. The parameters and objects are identical for logic block 2 ; Only the terms will be adjusted.

Device: 1.1.1 6-fold switch actuator 16A 230V current monitoring

<ul style="list-style-type: none"> Outputs 1-6: General - O1-6: Manual mode - O1-6: Status indications <li style="border: 1px solid #ccc;">- O1-6: Logic block 1 - O1-6: Logic block 2 Output 1: Function selection Output 2: Function selection Output 3: Function selection Output 4: Function selection Output 5: Function selection Output 6: Function selection Information 	<p>Logic function type: OR</p> <p>Number of logic input: 1</p> <p>Inverting value of logic input 1: Maintain status</p> <p>Value at initialization logic input 1: Value before initialization</p> <p>Authorization object logic block: Active</p> <p>Value at initialization: Value before initialization</p> <p>Polarity: 0 = Locked-up , 1 = Authorized</p> <p>Logic result after autorisation: Immediate emission when authorization</p> <p>Emission of logic result: By logic result value change</p> <p>Logic result acts on outputs: Active</p> <p>Output 1: Yes</p> <p>Output 2: Yes</p> <p>Output 3: Yes</p> <p>Output 4: Yes</p> <p>Output 5: Yes</p> <p>Output 6: Yes</p> <p>Action if logic result = 0: OFF</p> <p>Action if logic result = 1: ON</p>
--	--

* Default value

Operating principle of the logic block:

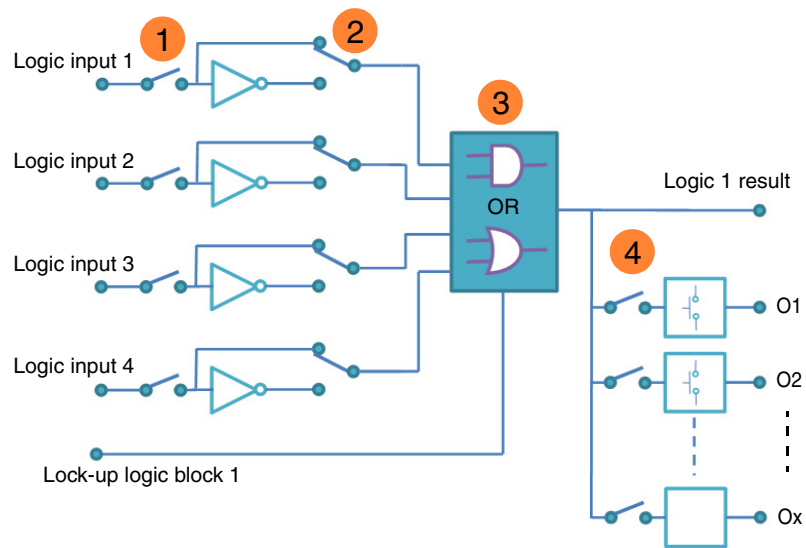

- ① Logic input number: Allows authorization of the logic input
- ② Logic input value: Inverted, yes or no
- ③ Type of logic function (AND or OR): Selection of the logic function
- ④ The logic result is applied to outputs: Selection of the outputs concerned by the logic operation

3.4.1 Configuration of the Logic function

Parameter	Description	Value
Logic function type	The input objects are: OR linked. AND linked.	OR* AND

For logic table see: [Appendix](#).

Parameter	Description	Value
Number of logic inputs	This parameter determines the number of inputs of the logic block. Up to 4 inputs can be used.	1* 2 3 4

* Default value

Communication objects:

- Block 1
 - 196 - Logic block 1 - input 2 (1 bit - 1.002 DPT_Bool)
 - 197 - Logic block 1 - input 3 (1 bit - 1.002 DPT_Bool)
 - 198 - Logic block 1 - input 4 (1 bit - 1.002 DPT_Bool)
- Block 2
 - 202 - Logic block 2 - input 2 (1 bit - 1.002 DPT_Bool)
 - 203 - Logic block 2 - input 3 (1 bit - 1.002 DPT_Bool)
 - 204 - Logic block 2 - input 4 (1 bit - 1.002 DPT_Bool)

Parameter	Description	Value
Inverting value of logic input x	The value of logic input x works on the logic block: With its object value (0=0, 1=1). With inverted object value (0=1, 1=0).	Maintain status* Status inversion

x = 1 to 4

Parameter	Description	Value
Value at initialization of logic input x	On initialization of the device after a download or after return of the bus power, the value of the logic input is: Set to 0. Set to 1. Set according to the value of the logic input before the initialization occurred.	0 1 Value before initialization*

3.4.2 Logic block authorization

Principle of logic block authorization:

The parameters are set as follows:

- Logic block authorization: 0 = Locked-up, 1 = Authorized.
- Action if logic result = 0 : Scene 1.
- Action if logic result = 1 : Scene 2.
- Logic input 1 and 2 are AND-linked.
- Emission of logic result: By input value change.

* Default value

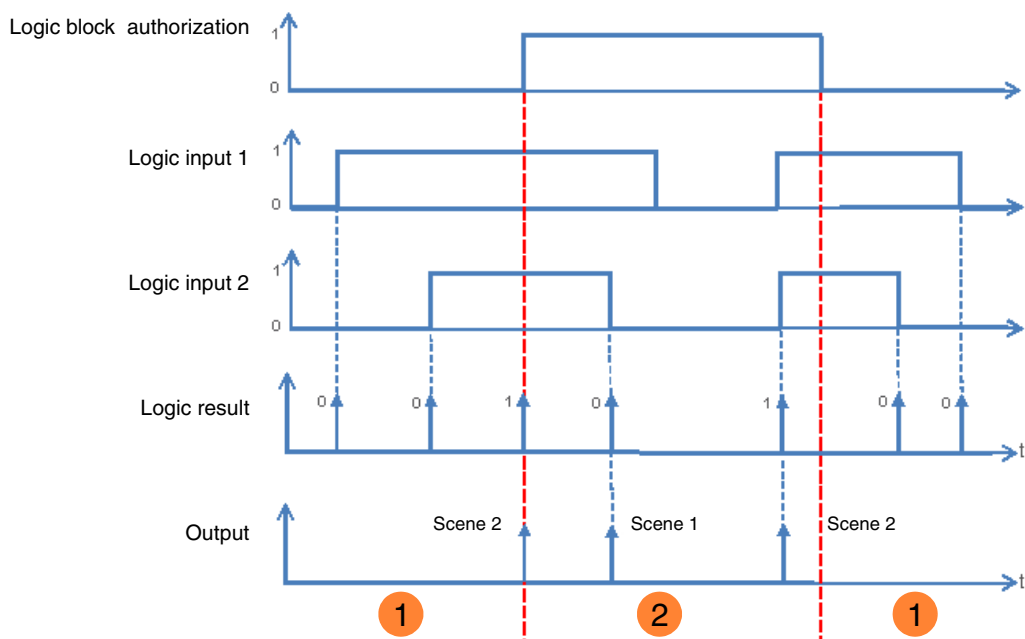

- 1 The logic result has no influence on the outputCurrent values.
- 2 The commands from the logic result are executed.

Note: The commands from the logic result are executed immediately after authorization, according to the **Logic result after authorization** parameter.

Parameter	Description	Value
Authorization object logic block	The Logic block 1 – Authorization communication object and related parameters are hidden.	Not active*
	The Logic block 1 – Authorization communication object and related parameters are displayed.	Active

Note: If the logic block is locked the logic operation is not processed.

Communication objects: Block 1 **194 - Logic block 1 - Authorization** (1 bit - 1.003 DPT_Enable)
 Block 2 **200 - Logic block 2 - Authorization** (1 bit - 1.003 DPT_Enable)

Parameter	Description	Value
Value at initialization	On initialization of the device after a download or after return of the bus power, the value of the Logic block 1 – Authorization object is: Set to 0. Set to 1. Set according to the value that the object had before initialization.	0 1 Value before initialization*

Note: This parameter is only visible if the **Authorization object logic block** parameter has the following value: **Active**.

* Default value

Parameter	Description	Value
Polarity	On receipt of a value on the Logic block 1 – Authorization object, this is: Locked-up on object value 1. Locked-up on object value 0.	0 = Authorized, 1 = Locked-up 0 = Locked-up, 1 = Authorized*

Note: This parameter is only visible if the **Authorization object logic block** parameter has the following value: **Active**.

Parameter	Description	Value
Logic result after autorisation	On authorization of the logic block: The value of the Logic result is immediately determined. The value of the logic result is first determined after receipt of a value on a logic input.	Immediate emission when authorization* No immediate emission

Note: This parameter is only visible if the **Authorization object logic block** parameter has the following value: **Active**.

3.4.3 Logic result

Parameter	Description	Value
Emission of logic result	The Logic result object will be sent on: Each receipt of a telegram on one of the logic inputs. A change in the value of the logic result.	By input value change By logic result value change*

Parameter	Description	Value
Logic result acts on outputs	The logic results acts: Only on the Logic result communication object. On the Logic result communication object and directly on one or more outputs.	Not active* Active

The status of the affected outputs is determined by the parameter **action on logic result = x**.

Parameter	Description	Value
Output 1 ... x	The output relationship with the Logic result is: Directly dependent. Independent.	Yes* No

Note: This parameter is only visible if the **Logic result acts on outputs** parameter has the following value: **Active**.

* Default value

Parameter	Description	Value
Action if logic result = 0	<p>On the outputs that are directly dependent on Logic result, if the output value = 0, the status:</p> <p>Not changed.</p> <p>Is switched to the opposite status.</p> <p>Selectively switched on.</p> <p>Selectively switched off.</p> <p>Starts timer mode.</p> <p>Stops timer mode.</p> <p>Starts one of the 64 scenes.</p> <p>Adopts the default value given by the parameter Status if preset 1 object = 0.</p> <p>Adopts the default value given by the parameter Status if preset 2 object = 0.</p>	<p>Maintain status</p> <p>Inversion</p> <p>ON</p> <p>OFF*</p> <p>Timer start</p> <p>Timer stop</p> <p>Scene number</p> <p>Preset 1</p> <p>Preset 2</p>

Note: The Timer mode, Scene function or Preset function of the selected output must be configured. If this is not the case, the status remains unchanged.

Parameter	Description	Value
Scene if logic result = 0	This parameter determines the scene number that is activated if the logic result is 0 after re-evaluation.	<p>Scene 1 ... 64</p> <p>Default value: 1</p>

The outputs respond according to the scene numbers and associated parameters.

*Note: This parameter is only visible if the **Action if logic result = 0** parameter has the following value: **Scene number**.*

Parameter	Description	Value
Action if logic result = 1	<p>On the outputs that are directly dependent on Logic result, if the output value = 1, the status:</p> <p>Not changed.</p> <p>Is switched to the opposite status.</p> <p>Selectively switched on.</p> <p>Selectively switched off.</p> <p>Starts timer mode.</p> <p>Stops timer mode.</p> <p>Starts one of the 64 scenes.</p> <p>Adopts the default value given by the parameter Status if preset 1 object = 1.</p> <p>Adopts the default value given by the parameter Status if preset 2 object = 1.</p>	<p>Maintain status</p> <p>Inversion</p> <p>ON*</p> <p>OFF</p> <p>Timer start</p> <p>Timer stop</p> <p>Scene number</p> <p>Preset 1</p> <p>Preset 2</p>

Note: The Timer mode, Scene function or Preset function of the selected output must be configured. If this is not the case, the status remains unchanged.

* Default value

Parameter	Description	Value
Scene if logic result = 1	This parameter determines the scene number that is activated if the logic result is 1 after re-evaluation.	Scene 1 ... 64 Default value: 2

The outputs respond according to the scene numbers and associated parameters.

*Note: This parameter is only visible if the **Action if logic result = 1** parameter has the following value: **Scene number**.*

* Default value

3.5 Diagnosis

The **Device diagnosis** object allows notifications about the operating status of the device to be sent via the KNX bus. This information is sent periodically and/or on status change.

The **Device diagnosis** object allows reporting of current faults according to the device and application. It also allows sending of the position of the switch on the front of the device and the number of the output that is affected by the fault(s).

The **Device Diagnosis** object is a 6-byte object that is composed as described below:

Byte number	6 (MSB)	5	4	3	2	1 (LSB)
Use	Switch position	Application type	Output number	Error codes		

Details of the byte:

- **Bytes 1 to 4:** Correspond to the error codes.

b31	b30	b29	b28	b27	b26	b25	b24	b23	b22	b21	b20	b19	b18	b17	b16	b15	b14	b13	b12	b11	b10	b9	b8	b7	b6	b5	b4	b3	b2	b1	b0
X	X	X	X	X	X	X	X	X	X	X	X	X	X	X	X	16	X	X	X	X	X	X	X	X	7	X	5	4	3	2	X

N°	Faults
2	Wrong context: The user's parameters are not transferable. The standard parameters are restored.
3	TP communication out of operation: Communication via the KNX bus was not available on the previous start.
4	The relay of the output concerned is caught: The output contact is mechanically damaged.
5	Overcurrent on the output concerned: The output current flowing through the output contact is too high.
7	Minimum switching time not complied with: The device is equipped with a mechanism for limiting the number of switching cycles per minute of the output contact. If the user requires a number of switching cycles that is greater than this limit, this bit informs the user that his command was not carried out.
16	Excessive number of restarts: This bit is use for notification of repeated restarts and/or a restart triggered by a Watch-Dog. Such a restart is not necessarily apparent to the user from the function, rather it is manifest as a disturbed environment or a bad contact of the power supply.

Note: The use of the standard bit depends on the type of device used (switch actuator, dimmer, shutter/blind, etc.). Certain bit are same for all devices and others are application-specific.

- **Byte 5:** Corresponds to the application type and the number of the output affected by the error.

b7	b6	b5	b4	b3	b2	b1	b0
Application type				Output number			
0 = Not defined				0 = Device error			
1 = Switch actuator				1 = Output 1			
2 = Shutter/blind				2 = Output 2			
3 = Dimmer						
				Y = Output Y			

Note: Y is the placeholder for the maximum number of outputs.

- **Byte 6:** Switch position.

b7	b6	b5	b4	b3	b2	b1	b0
X	X	X	X	X	X	X	1

1: 0 = Automatic mode / 1 = Manual mode

Note: Bit marked with an x are not used.

* Default value

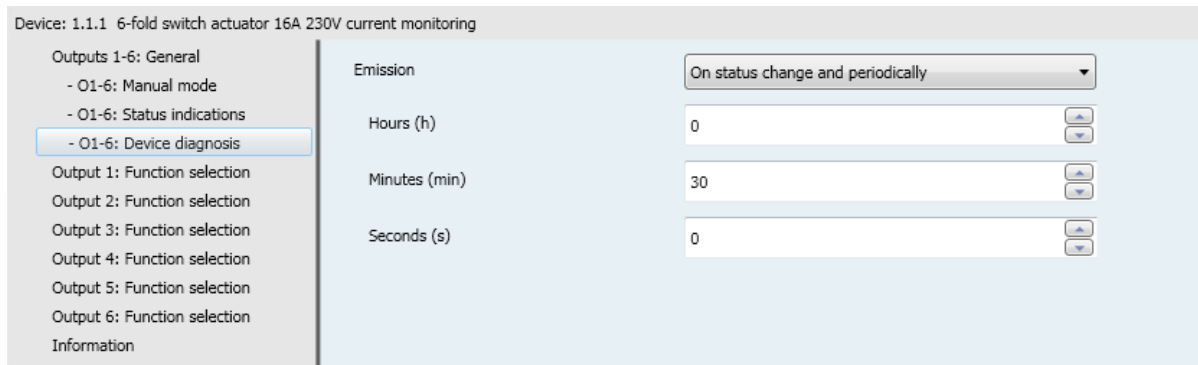

Parameter	Description	Value
Emission	The Device diagnosis communication object is sent to bus: On each change. Periodically after a configurable time. On change and periodically after a configurable time.	On status change* Periodically On status change and periodically

Parameter	Description	Value
Hours (h)	This parameter determines the time between the individual transmissions of the Device diagnosis object.	0 hours: 0 to 23 h
Minutes (min)		30 minutes: 0 to 59 min
Seconds (s)		0 seconds: 0 to 59 s

Note: The smallest executable time is 1 second.

*Note: This parameter is only visible if the **Emission** parameter has the following value: **Periodically** or **On status change and periodically**.*

* Default value

3.6 Function selection

This parameter window is used to set the device outputs. These parameters are available individually for each output.

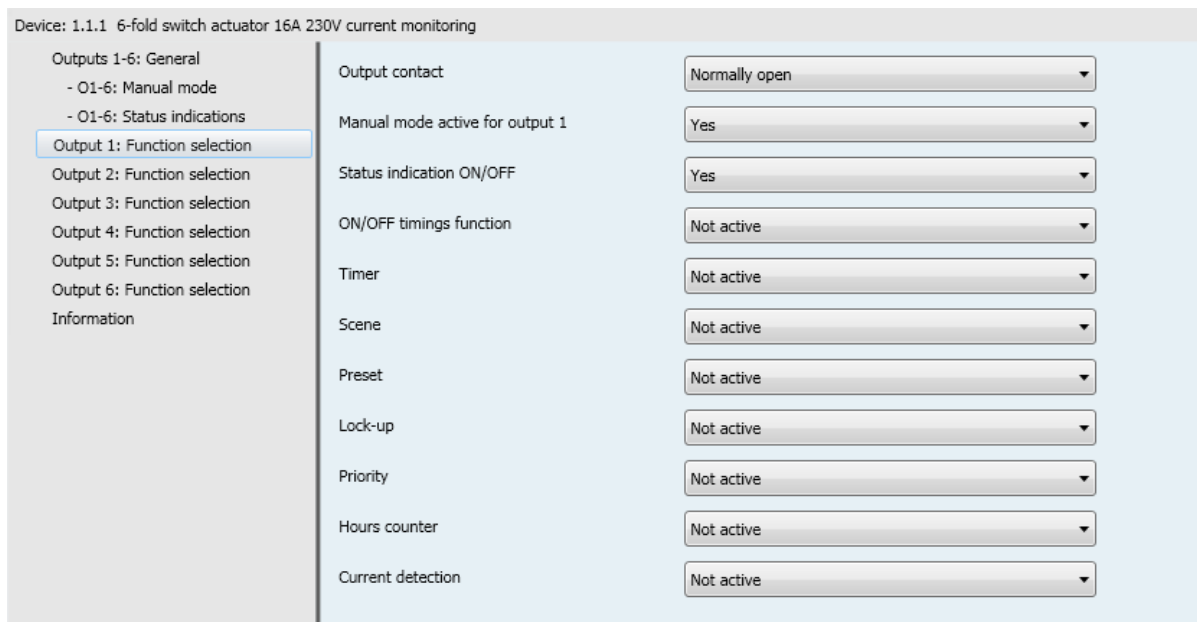

3.6.1 Definition

Parameter	Description	Value
Output contact	On receipt of an ON command: The output relay closes. The output relay opens.	Normally open* Normally closed

Principle:

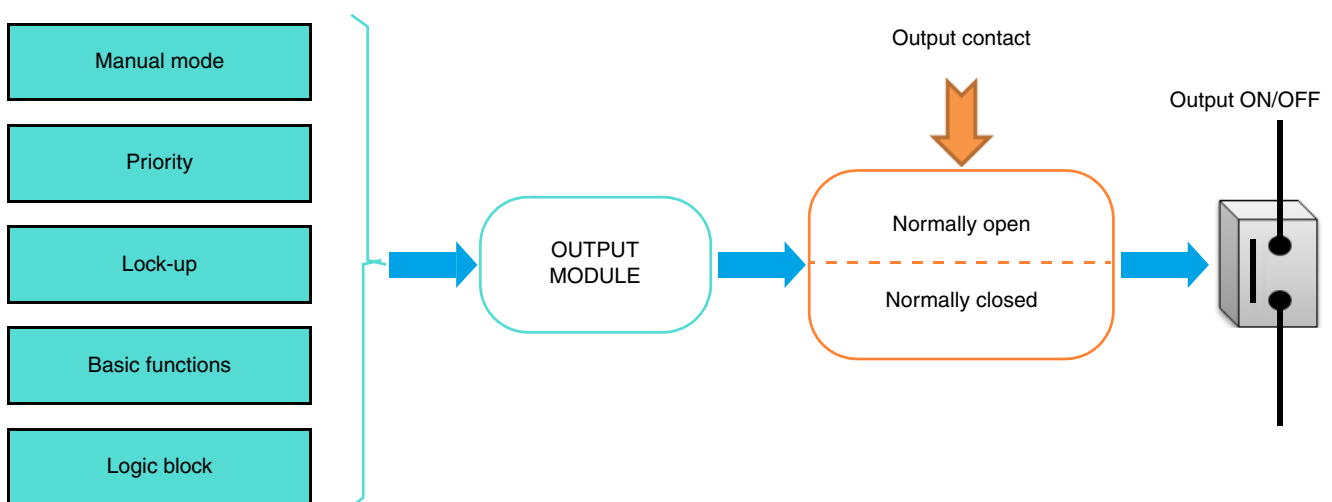

* Default value

Parameter	Description	Value
Manual mode active for output 1	This output can be controlled in manual mode.	Yes*
	This output is excluded from manual mode.	No

Parameter	Description	Value
Status indication ON/OFF	The Status indication ON/OFF communication object is: Hidden.	No
	Displayed, the status indication can be transmitted over the bus.	Yes*

Communication objects:

- [3 - Output 1 - Status indication ON/OFF](#) (1 bit - 1.001 DPT_Switch)
- [35 - Output 2 - Status indication ON/OFF](#) (1 bit - 1.001 DPT_Switch)
- [67 - Output 3 - Status indication ON/OFF](#) (1 bit - 1.001 DPT_Switch)
- [99 - Output 4 - Status indication ON/OFF](#) (1 bit - 1.001 DPT_Switch)
- [131 - Output 5 - Status indication ON/OFF](#) (1 bit - 1.001 DPT_Switch)
- [163 - Output 6 - Status indication ON/OFF](#) (1 bit - 1.001 DPT_Switch)

*Note: The transmission conditions for the Status indication objects must be set in the parameter Register **O1-Ox: Status indication**.*

Parameter	Description	Value
ON/OFF timings function	The ON/OFF timings function tab and the associated parameters and objects are: Hidden.	Not active*
	Displayed.	Active

For configuration see section: [ON/OFF timings function](#).

Parameter	Description	Value
Timer	The Timer tab and the associated parameters and objects are: Hidden.	Not active*
	Displayed.	Active

Communication objects:

- [4 - Output 1 - Timer](#) (1 bit - 1.001 DPT_Switch)
- [36 - Output 2 - Timer](#) (1 bit - 1.001 DPT_Switch)
- [68 - Output 3 - Timer](#) (1 bit - 1.001 DPT_Switch)
- [100 - Output 4 - Timer](#) (1 bit - 1.001 DPT_Switch)
- [132 - Output 5 - Timer](#) (1 bit - 1.001 DPT_Switch)
- [164 - Output 6 - Timer](#) (1 bit - 1.001 DPT_Switch)

For configuration see section: [Timer](#).

* Default value

Parameter	Description	Value
Scene	The Scenes tab and the associated parameters and objects are: Hidden. Displayed.	Not active* Active

Communication objects:

- 6 - Output 1 - Scene** (1 byte - 17.001 DPT_SceneNumber)
- 38 - Output 2 - Scene** (1 byte - 17.001 DPT_SceneNumber)
- 70 - Output 3 - Scene** (1 byte - 17.001 DPT_SceneNumber)
- 102 - Output 4 - Scene** (1 byte - 17.001 DPT_SceneNumber)
- 134 - Output 5 - Scene** (1 byte - 17.001 DPT_SceneNumber)
- 166 - Output 6 - Scene** (1 byte - 17.001 DPT_SceneNumber)

For configuration see section: [Scene](#).

Parameter	Description	Value
Preset	The Preset tab and the associated parameters and objects are: Hidden. Displayed for 1 Preset object. Displayed for 2 Preset objects.	Not active* Active with preset 1-level object Active with preset 2-level objects

Note: When the value of this parameter changes, the associated parameters and group addresses are deleted.

Preset 1 communication Objects

- 7 - Output 1 - Preset 1** (1 bit - 1.022 DPT_Scene_AB)
- 39 - Output 2 - Preset 1** (1 bit - 1.022 DPT_Scene_AB)
- 71 - Output 3 - Preset 1** (1 bit - 1.022 DPT_Scene_AB)
- 103 - Output 4 - Preset 1** (1 bit - 1.022 DPT_Scene_AB)
- 135 - Output 5 - Preset 1** (1 bit - 1.022 DPT_Scene_AB)
- 167 - Output 6 - Preset 1** (1 bit - 1.022 DPT_Scene_AB)

Preset 2 communication Objects

- 8 - Output 1 - Preset 2** (1 bit - 1.022 DPT_Scene_AB)
- 40 - Output 2 - Preset 2** (1 bit - 1.022 DPT_Scene_AB)
- 72 - Output 3 - Preset 2** (1 bit - 1.022 DPT_Scene_AB)
- 104 - Output 4 - Preset 2** (1 bit - 1.022 DPT_Scene_AB)
- 136 - Output 5 - Preset 2** (1 bit - 1.022 DPT_Scene_AB)
- 168 - Output 6 - Preset 2** (1 bit - 1.022 DPT_Scene_AB)

For configuration see section: [Preset](#).

* Default value

Parameter	Description	Value
Lock-up	The Lock-up tab and the associated parameters and objects are: Hidden. Displayed for 1 lock-up object. Displayed for 2 lock-up objects.	Not active* 1 lock-up object 2 lock-up objects

Lock-up 1 communication objects

- [11 - Output 1 - Lock-up 1](#) (1 bit - 1.003 DPT_Enable)
- [43 - Output 2 - Lock-up 1](#) (1 bit - 1.003 DPT_Enable)
- [75 - Output 3 - Lock-up 1](#) (1 bit - 1.003 DPT_Enable)
- [107 - Output 4 - Lock-up 1](#) (1 bit - 1.003 DPT_Enable)
- [139 - Output 5 - Lock-up 1](#) (1 bit - 1.003 DPT_Enable)
- [171 - Output 6 - Lock-up 1](#) (1 bit - 1.003 DPT_Enable)

Lock-up 2 communication objects

- [12 - Output 1 - Lock-up 2](#) (1 bit - 1.003 DPT_Enable)
- [44 - Output 2 - Lock-up 2](#) (1 bit - 1.003 DPT_Enable)
- [76 - Output 3 - Lock-up 2](#) (1 bit - 1.003 DPT_Enable)
- [108 - Output 4 - Lock-up 2](#) (1 bit - 1.003 DPT_Enable)
- [140 - Output 5 - Lock-up 2](#) (1 bit - 1.003 DPT_Enable)
- [172 - Output 6 - Lock-up 2](#) (1 bit - 1.003 DPT_Enable)

For configuration see section: [Lock-up](#).

Parameter	Description	Value
Priority	The Priority tab and the associated parameters and objects are: Hidden. Displayed.	Not active* Active

The device responds to telegrams received via the **Priority** object, as given in the following table:

Telegram received by the priority operation object		Status of the outputs
Bit 1	Bit 2	
0	0	End of the priority
0	1	End of the priority
1	0	Priority OFF
1	1	Priority ON

Communication objects:

- [14 - Output 1 - Priority](#) (2 bit - 2.002 DPT_Bool_Control)
- [46 - Output 2 - Priority](#) (2 bit - 2.002 DPT_Bool_Control)
- [78 - Output 3 - Priority](#) (2 bit - 2.002 DPT_Bool_Control)
- [110 - Output 4 - Priority](#) (2 bit - 2.002 DPT_Bool_Control)
- [142 - Output 5 - Priority](#) (2 bit - 2.002 DPT_Bool_Control)
- [174 - Output 6 - Priority](#) (2 bit - 2.002 DPT_Bool_Control)

For configuration see section: [Priority](#).

* Default value

Parameter	Description	Value
Hours counter	The Hours counter tab and the associated parameters and objects are: Hidden. Displayed.	Not active* Active

A telegram can be transmitted via the **Hours counter setpoint reached** object, in accordance with a programmable setpoint. It is also possible to reset the count value via a 1 signal on the **Reset hours counter value** object.

Communication objects:

16 - Output 1 - Hours counter value (2 byte - 7.001 DPT_16_bit_Counter)

48 - Output 2 - Hours counter value (2 byte - 7.001 DPT_16_bit_Counter)

80 - Output 3 - Hours counter value (2 byte - 7.001 DPT_16_bit_Counter)

112 - Output 4 - Hours counter value (2 byte - 7.001 DPT_16_bit_Counter)

144 - Output 5 - Hours counter value (2 byte - 7.001 DPT_16_bit_Counter)

176 - Output 6 - Hours counter value (2 byte - 7.001 DPT_16_bit_Counter)

17 - Output 1 - Reset hours counter value (1 bit - 1.015 DPT_Reset)

49 - Output 2 - Reset hours counter value (1 bit - 1.015 DPT_Reset)

81 - Output 3 - Reset hours counter value (1 bit - 1.015 DPT_Reset)

113 - Output 4 - Reset hours counter value (1 bit - 1.015 DPT_Reset)

145 - Output 5 - Reset hours counter value (1 bit - 1.015 DPT_Reset)

177 - Output 6 - Reset hours counter value (1 bit - 1.015 DPT_Reset)

18 - Output 1 - Hours counter setpoint reached (1 bit - 1.002 DPT_Bool)

50 - Output 2 - Hours counter setpoint reached (1 bit - 1.002 DPT_Bool)

82 - Output 3 - Hours counter setpoint reached (1 bit - 1.002 DPT_Bool)

114 - Output 4 - Hours counter setpoint reached (1 bit - 1.002 DPT_Bool)

146 - Output 5 - Hours counter setpoint reached (1 bit - 1.002 DPT_Bool)

178 - Output 6 - Hours counter setpoint reached (1 bit - 1.002 DPT_Bool)

For configuration see section: [Hours counter](#).

Parameter	Description	Value
Current detection	The Current detection tab and the associated parameters and objects are: Hidden. Displayed.	Not active* Active

For configuration see section: [Current detection](#).

* Default value

3.6.2 ON/OFF timings function

Device: 1.1.1 6-fold switch actuator 16A 230V current monitoring

Outputs 1-6: General

- O1-6: Manual mode
- O1-6: Status indications

Output 1: Function selection

- O1: ON/OFF object timings

Output 2: Function selection

Output 3: Function selection

Output 4: Function selection

Output 5: Function selection

Output 6: Function selection

Information

Delays for ON/OFF objects

Switching and tripping delay ▾

Switching delay (h) ▲ ▼

Switching delay (min) ▲ ▼

Switching delay (s), minimum value 1s ▲ ▼

Tripping delay (h) ▲ ▼

Tripping delay (min) ▲ ▼

Tripping delay (s), minimum value 1s ▲ ▼

Timer/toggle switch changeover for object ON/OFF

Active ▾

Hours (h) ▲ ▼

Minutes (min) ▲ ▼

Seconds (s), minimum value 1s ▲ ▼

Additional time limited toggle switch function

Active ▾

Hours (h) ▲ ▼

Minutes (min) ▲ ▼

Seconds (s), minimum value 1s ▲ ▼

3.6.2.1 Delays for ON/OFF objects

Parameter	Description	Value
Delays for ON/OFF objects	<p>The parameters for time-delayed switching of the outputs are:</p> <p>Hidden.</p> <p>Displayed for Switching delay.</p> <p>Displayed for Tripping delay.</p> <p>Displayed for Switching and tripping delay.</p>	<p>Not active*</p> <p>Switching delay</p> <p>Tripping delay</p> <p>Switching and tripping delay</p>

* Default value

Switching delay: Allows the configuration of a delay between the switch-on command and the switching of the output contact.

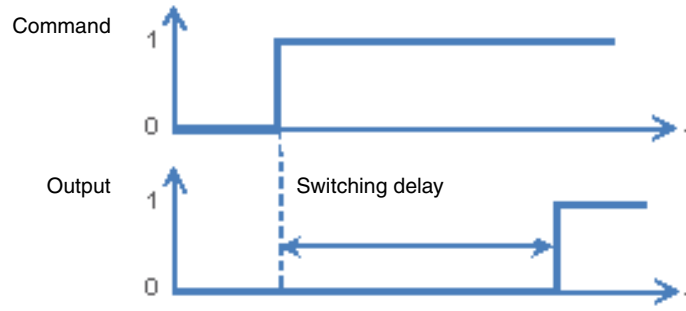

Tripping delay: Allows the configuration of a delay between the switch-off command and the switching of the output contact.

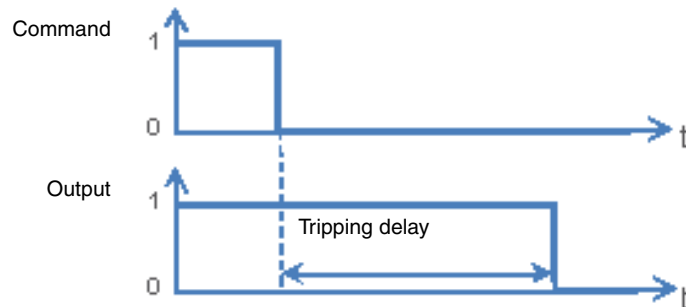

Switching and tripping delay: Allows the configuration of a delay between the switch-on command and the switching of the output contact, as well as between the switch-off command and the switching of the output contact.

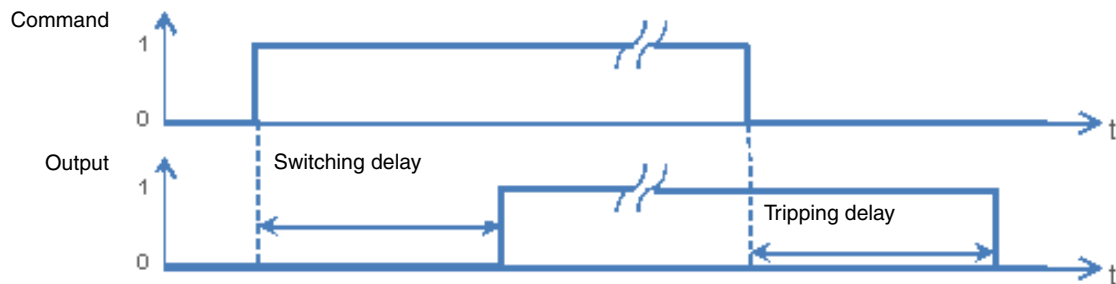

Parameter	Description	Value
Switching delay	This parameter defines the delay between the switch-on command and the switching of the output contact.	0 hours: 0 to 23 h 3 minutes: 0 to 59 min 0 seconds: 0 to 59 s

Note: The smallest executable time is 1 second.

*Note: This parameter is only visible if the **Delays for ON/OFF** objects parameter has the following value: **Switching delay** or **Switching and tripping delay**.*

Parameter	Description	Value
Tripping delay	This parameter defines the delay between the switch-off command and the switching of the output contact.	0 hours: 0 to 23 h 3 minutes: 0 to 59 min 0 seconds: 0 to 59 s

Note: The smallest executable time is 1 second.

*Note: This parameter is only visible if the **Delays for ON/OFF** objects parameter has the following value: **Tripping delay** or **Switching and tripping delay**.*

* Default value

3.6.2.2 Timer/toggle switch changeover for ON/OFF object

This function switches the output channels between toggle switch and timer mode for the **ON/OFF** object.

Example: Switching function daytime and Time-limited OFF function at night.

During the day, the button is used as a switch. In the evenings, the button is used as a time-limited OFF switch, so that the light will turn off automatically.

Parameter	Description	Value
ON/OFF	The parameters for a switch-over between toggle switch and timer modes for the ON/OFF object are: Hidden. Displayed.	Not active* Active

- If the **Timer/toggle switch changeover** object receives the value 1, the Toggle-switch mode function is activated. The ON/OFF switching of the output is performed as usual via the **ON/OFF** object.
- If the **Timer/toggle switch changeover** object receives the value 0, the Timer mode function is activated.
 - If the **ON/OFF** object receives the value 1, the output is switched ON. After expiry of a configurable time, the output is automatically switched OFF.
 - If the **ON/OFF** object receives the value 0, the output is switched OFF.

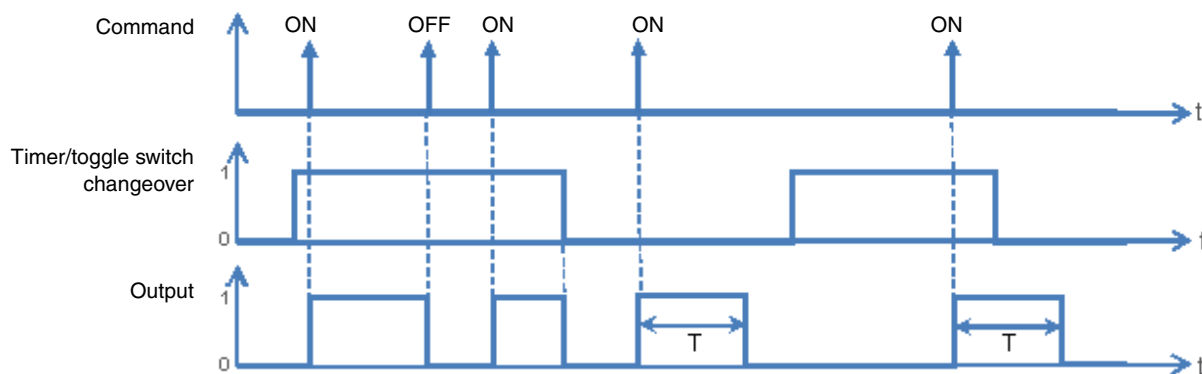

Communication objects:

- 1 - Output 1 - Timer/toggle switch changeover (1 bit - 1.001 DPT_Switch)**
- 35 - Output 2 - Timer/toggle switch changeover (1 bit - 1.001 DPT_Switch)**
- 65 - Output 3 - Timer/toggle switch changeover (1 bit - 1.001 DPT_Switch)**
- 97 - Output 4 - Timer/toggle switch changeover (1 bit - 1.001 DPT_Switch)**
- 129 - Output 5 - Timer/toggle switch changeover (1 bit - 1.001 DPT_Switch)**
- 161 - Output 6 - Timer/toggle switch changeover (1 bit - 1.001 DPT_Switch)**

Parameter	Description	Value
Hours (h)	This parameter sets the length of the timer operation, if this is activated.	1 hours: 0 to 23 h
Minutes (min)		0 minutes: 0 to 59 min
Seconds (s)		0 seconds: 0 to 59 s

Note: The smallest executable time is 1 second.

*Note: This parameter is only visible if the **Timer/toggle switch changeover parameter for the ON/OFF object** has the following value: **Active**.*

* Default value

3.6.2.3 Time limited toggle switch

The Time-limited OFF function enables automatic switch off after a programmable Time-limited OFF time. The output works as a normal switch actuator but is switched off after a given time for security.

Example: Attic, the lighting can be switched normally but switches off after not more than 3 hours.

Parameter	Description	Value
Additional time limited toggle switch function	The parameters for setting the Time-limited OFF time are: Hidden. Displayed.	Not active* Active

Function diagram

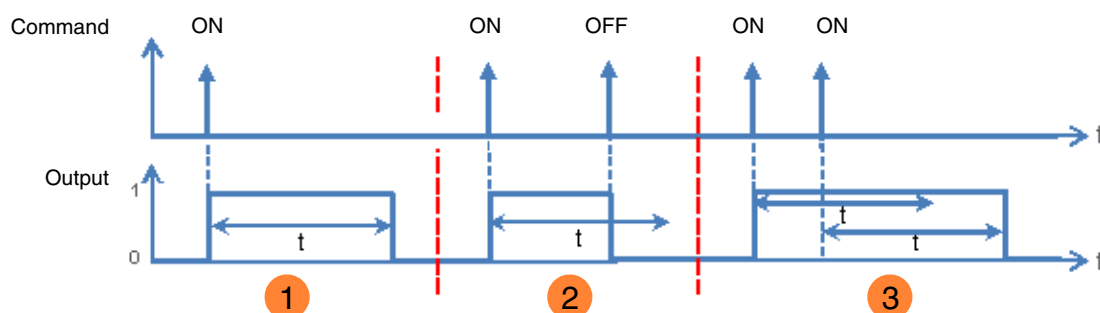

- 1 Emission of an ON command: The output which is at ON will switch to OFF on expiry of the Time-limited OFF time.
- 2 Emission of an ON command: The output switches to ON.
Emission of an OFF command before expiry of the Time-limited OFF time, t : The output switches to OFF.
- 3 Emission of an ON command: The output switches to ON.
Emission of an ON command before expiry of the Time-limited OFF time, t : The output remains at ON and the Time-limited OFF time, t , is re-started.

- Communication objects:
- 2 - Output 1 - Time limited toggle switch object (1 bit - 1.001 DPT_Switch)
 - 34 - Output 2 - Time limited toggle switch object (1 bit - 1.001 DPT_Switch)
 - 66 - Output 3 - Time limited toggle switch object (1 bit - 1.001 DPT_Switch)
 - 98 - Output 4 - Time limited toggle switch object (1 bit - 1.001 DPT_Switch)
 - 130 - Output 5 - Time limited toggle switch object (1 bit - 1.001 DPT_Switch)
 - 162 - Output 6 - Time limited toggle switch object (1 bit - 1.001 DPT_Switch)

Parameter	Description	Value
Hours (h)	This parameter sets the length of the timer operation for the Time-limited toggle switch, if this is activated.	1 hours: 0 to 23 h
Minutes (min)		0 minutes: 0 to 59 min
Seconds (s)		0 seconds: 0 to 59 s

Note: The smallest executable time is 1 second.

*Note: This parameter is only visible if the **Additional time limited toggle switch function** parameter has the following value: **Active**.*

* Default value

3.6.3 Timer

The Timer function can switch a lighting circuit on or off for a configurable period. According to the selected operating mode of the timer, the output can be turned ON or OFF for a determined period of time. The timer may be interrupted before expiry of the delay time. A programmable Cut-OFF pre-warning announces the end of the delay time by a 1-second inversion of the output status.

Device: 1.1.1 6-fold switch actuator 16A 230V current monitoring

Outputs 1-6: General

- O1-6: Manual mode
- O1-6: Status indications

Output 1: Function selection

- O1: Timer

Output 2: Function selection

Output 3: Function selection

Output 4: Function selection

Output 5: Function selection

Output 6: Function selection

Information

Timer operation ON

Timer duration (h) 0

Timer duration (min) 3

Timer duration (s), minimum value 1s 0

Cut-OFF pre-warning Active

Hours (h) 0

Minutes (min) 0

Seconds (s) 30

Timer interruption Yes

Timer retriggerability Yes

Timer duration extension (10 first seconds) Unlimited

Timer duration modifiable through object Not active

3.6.3.1 Timer operation

Parameter	Description	Value
Timer operation	When the timer is active, the output for the Timer duration is: Selectively switched on. Selectively switched off. Switched alternately ON and OFF. (Blink time is configurable via additional parameters.)	ON* OFF Blinking

Parameter	Description	Value
Timer duration	This parameter determines the timer duration.	0 hours: 0 to 23 h 2 minutes: 0 to 59 min 0 seconds: 0 to 59 s

Note: The smallest executable time is 1 second.

Parameter	Description	Value
Blinking ON duration (s)	This parameter determines the closing duration of the output contact when blinking.	5 seconds: 5 to 240 s

*Note: This parameter is only visible if the **Timer operation** parameter has the following value: **Blinking**.*

* Default value

Parameter	Description	Value
Blinking OFF duration (s)	This parameter determines the opening duration of the output contact when blinking.	5 seconds: 5 to 240 s

Note: This parameter is only visible if the **Timer operation** parameter has the following value: **Blinking**.

Parameter	Description	Value
Output status during blinking function	When the switch actuator is blinking, the Status indication ON/OFF object sends: The value, 1 = ON. The value, 0 = OFF. The values 1 and 0 alternately. (The status object blinks accordingly.)	ON* OFF ON/OFF

Note: This parameter is only visible if the **Timer operation** parameter has the following value: **Blinking**.

3.6.3.2 Cut-OFF pre-warning

Parameter	Description	Value
Cut-OFF pre-warning	Before expiry of the timer delay there is: No warning. A warning through a 1-second inversion of the output status. The lead time of this warning can be set.	Not active Active*

Parameter	Description	Value
Hours (h)	This parameter determines the lead time of the cut-OFF pre-warning.	0 hours: 0 to 23 h
Minutes (min)		0 minutes: 0 to 59 min
Seconds (s)		30 seconds: 0 to 59 s

Note: The smallest executable time is 1 second.

Note: This parameter is only visible if the **Cut-OFF pre-warning** parameter has the following value: **Active**.

Note: If the lead time of the cut-OFF pre-warning is greater than the duration of the timer, the cut-OFF pre-warning is not triggered.

3.6.3.3 Configuration

Parameter	Description	Value
Timer interruption	On receiving the value 0 on the Timer communication object, the timing is: Interrupted. Not interrupted.	Yes* No

Parameter	Description	Value
Timer retriggerability	The parameter Timer duration extension (10 first seconds) is: Hidden. Displayed.	No Yes*

* Default value

Parameter	Description	Value
Timer duration extension (10 first seconds)	<p>If, during the first 10 seconds of the timer duration, multiple commands with the value 1 are received on the Timer communication object, it is:</p> <p>Multiplied unlimited times.</p> <p>Multiplied a maximum of 1x.</p> <p>Multiplied a maximum of 2x.</p> <p>Multiplied a maximum of 3x.</p> <p>Multiplied a maximum of 4x.</p> <p>Multiplied a maximum of 5x.</p>	<p>Unlimited*</p> <p>1-time duration extension</p> <p>2-time duration extension</p> <p>3-time duration extension</p> <p>4-time duration extension</p> <p>5-time duration extension</p>

Parameter	Description	Value
Timer duration modifiable through object	<p>The Timer duration communication object is:</p> <p>Hidden.</p> <p>Displayed, the timer duration can be transmitted via the bus.</p>	<p>Not active*</p> <p>Active</p>

Communication objects:

- [5 - Output 1 - Timer duration \(3 byte - 10.001 DPT_TimeOfDay\)](#)
- [37 - Output 2 - Timer duration \(3 byte - 10.001 DPT_TimeOfDay\)](#)
- [69 - Output 3 - Timer duration \(3 byte - 10.001 DPT_TimeOfDay\)](#)
- [101 - Output 4 - Timer duration \(3 byte - 10.001 DPT_TimeOfDay\)](#)
- [133 - Output 5 - Timer duration \(3 byte - 10.001 DPT_TimeOfDay\)](#)
- [165 - Output 6 - Timer duration \(3 byte - 10.001 DPT_TimeOfDay\)](#)

* Default value

3.6.4 Scene

Device: 1.1.1 6-fold switch actuator 16A 230V current monitoring

<ul style="list-style-type: none"> Outputs 1-6: General <ul style="list-style-type: none"> - O1-6: Manual mode - O1-6: Status indications Output 1: Function selection <ul style="list-style-type: none"> - O1: Scenes Output 2: Function selection Output 3: Function selection Output 4: Function selection Output 5: Function selection Output 6: Function selection Information 	<p>Number of scenes used <input type="text" value="8"/></p> <p>Scenes memorisation by long key press <input type="text" value="Active"/></p> <p>Scenes memorisation acknowledgment (Output status inversed for 3s) <input type="text" value="Not active"/></p> <p>Output status for scene 1 <input type="text" value="Not active"/></p> <p>Output status for scene 2 <input type="text" value="Not active"/></p> <p>Output status for scene 3 <input type="text" value="Not active"/></p> <p>Output status for scene 4 <input type="text" value="Not active"/></p> <p>Output status for scene 5 <input type="text" value="Not active"/></p> <p>Output status for scene 6 <input type="text" value="Not active"/></p> <p>Output status for scene 7 <input type="text" value="Not active"/></p> <p>Output status for scene 8 <input type="text" value="Not active"/></p> <p>Blinking ON duration (s) <input type="text" value="5"/></p> <p>Blinking OFF duration (s) <input type="text" value="5"/></p> <p>Output status during blinking function <input type="text" value="ON"/></p>
--	---

Parameter	Description	Value
Number of scenes used	This parameter determines the number of scenes used.	8* - 16 - 24 - 32 - 48 - 64

Note: If the Scene number received on the Scene object is greater than the maximum number of scenes, the status of the output remains unchanged.

Parameter	Description	Value
Scenes memorisation by very long key press	This parameter allows learning and storing of a scene by, for example, a long press (> 5 seconds) of the corresponding push button.	Not active Active*

Learning and storing scenes

This process is used to change and store a scene. For example, by locally pressing the key in the room or by emission of the values from a visualization.

* Default value

To access and store scenes, the following values must be sent:

Scene number	Access scene (Object value: 1 byte)	Store scene (Object value: 1 byte)
1 - 64	= Scene number - 1	= Scene number + 128
Example		
1	0	128
2	1	129
3	2	130
...	...	
64	63	191

Here is the scene memorisation for local switches, for example.

- Activate scene by briefly pressing the transmitter that starts it.
- The outputs (lights, shutters, etc.) are set in the desired state using the usual local control devices (buttons, remote control, etc.).
- Memorise the status of the outputs with a press greater than 5 seconds long on the transmitter that starts the scene. The memorisation can be displayed by short-term activation of the outputs.

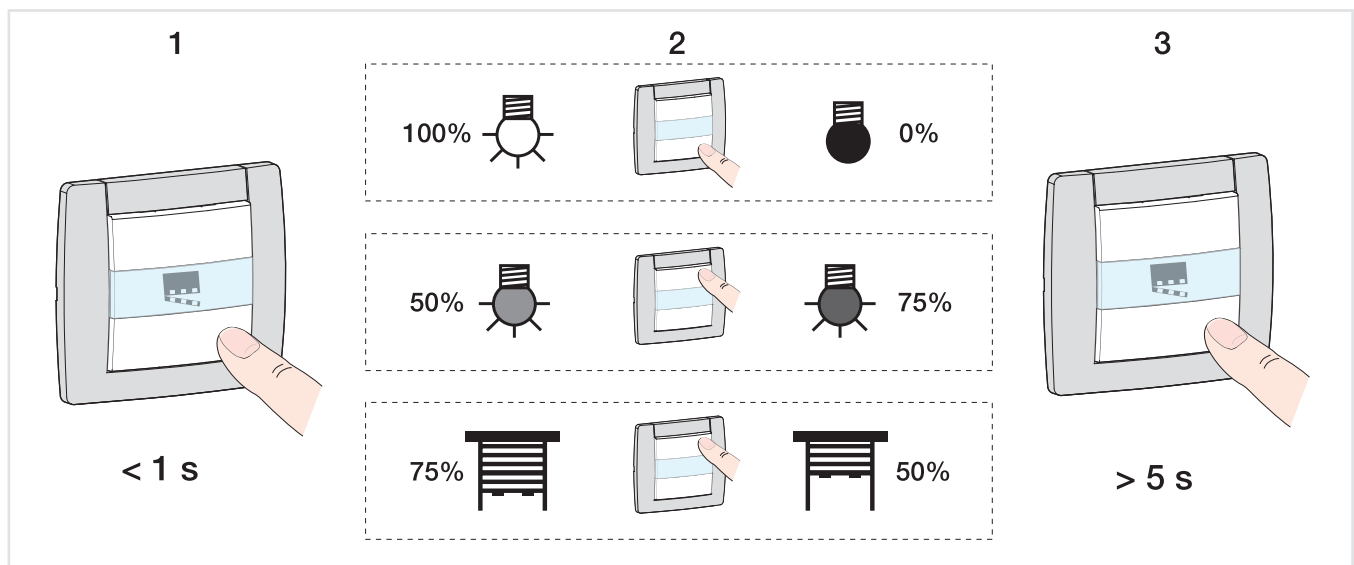

Parameter	Description	Value
Scenes memorisation acknowledgment	Memorisation of a scene is: Not acknowledged. Acknowledged by the output by a 3 second long inversion of the output status.	Not active* Active

* Default value

Parameter	Description	Value
Output status for scene X	On activation of Scene X, the output is: Not changed. Selectively switched on. Selectively switched off. Switched alternately ON and OFF. (Blink time is configurable via additional parameters.)	Not active* ON OFF Blinking

X = 1 to 64

*Note: Each output has up to 64 scenes available, in accordance with the **Number of scenes used** parameter.*

*Note: Local storage of the scene is not recorded if the **Output status for scene X** parameter is not active or is blinking.*

Parameter	Description	Value
Blinking ON duration (s)	This parameter determines the closing duration of the output contact when blinking.	5 seconds: 5 to 240 s

*Note: This parameter applies to all scenes involving the respective output, which has the following value: **Blinking**.*

Parameter	Description	Value
Blinking OFF duration (s)	This parameter determines the opening duration of the output contact when blinking.	5 seconds: 5 to 240 s

*Note: This parameter applies to all scenes involving the respective output, which has the following value: **Blinking**.*

Parameter	Description	Value
Output status during blinking function	When the switch actuator is blinking, the Status indication ON/OFF object sends: The value, 1 = ON. The value, 1 = OFF. The values 1 and 0 alternately. (The status object blinks accordingly.)	ON* OFF ON/OFF

*Note: This parameter applies to all scenes involving the respective output, which has the following value: **Blinking**.*

* Default value

3.6.5 Preset

Device: 1.1.1 6-fold switch actuator 16A 230V current monitoring

<p>Outputs 1-6: General</p> <ul style="list-style-type: none"> - O1-6: Manual mode - O1-6: Status indications <p>Output 1: Function selection</p> <ul style="list-style-type: none"> - O1: Preset <p>Output 2: Function selection</p> <p>Output 3: Function selection</p> <p>Output 4: Function selection</p> <p>Output 5: Function selection</p> <p>Output 6: Function selection</p> <p>Information</p>	<p>Preset authorization objects</p> <p>Value of authorization preset 1 at initialization</p> <p>Value of authorization preset 2 at initialization</p> <p>Polarity of Preset 1 authorization object</p> <p>Polarity of Preset 2 authorization object</p> <p>Status if preset 1 object = 0</p> <p>Scene for preset 1 = 0</p> <p>Status if preset 1 object = 1</p> <p>Blinking ON duration (s)</p> <p>Blinking OFF duration (s)</p> <p>Output status during blinking function</p> <p>Status if preset 2 object = 0</p> <p>Status if preset 2 object = 1</p>	<p>Active</p> <p>Value before initialization</p> <p>Value before initialization</p> <p>0 = Locked-up , 1 = Authorized</p> <p>0 = Locked-up , 1 = Authorized</p> <p>Scene number</p> <p>1</p> <p>Blinking</p> <p>5</p> <p>5</p> <p>ON</p> <p>Maintain status</p> <p>Maintain status</p>
---	--	--

The Preset function is used to switch an output into various predefined states. The Preset function is activated via an object in 1-bit format.

Principle of Preset authorization:

The parameters are set as follows:

- Polarity of autorisation object Preset 1: 0 = Locked-up, 1 = Authorized.
- Polarity of autorisation object Preset 2: 0 = Locked-up, 1 = Authorized.
- Status if preset 1 object = 0: ON.
- Status if preset 1 object = 1: OFF.
- Status if preset 2 object = 0: Scene 1.
- Status if preset 2 object = 1: Scene 2.

* Default value

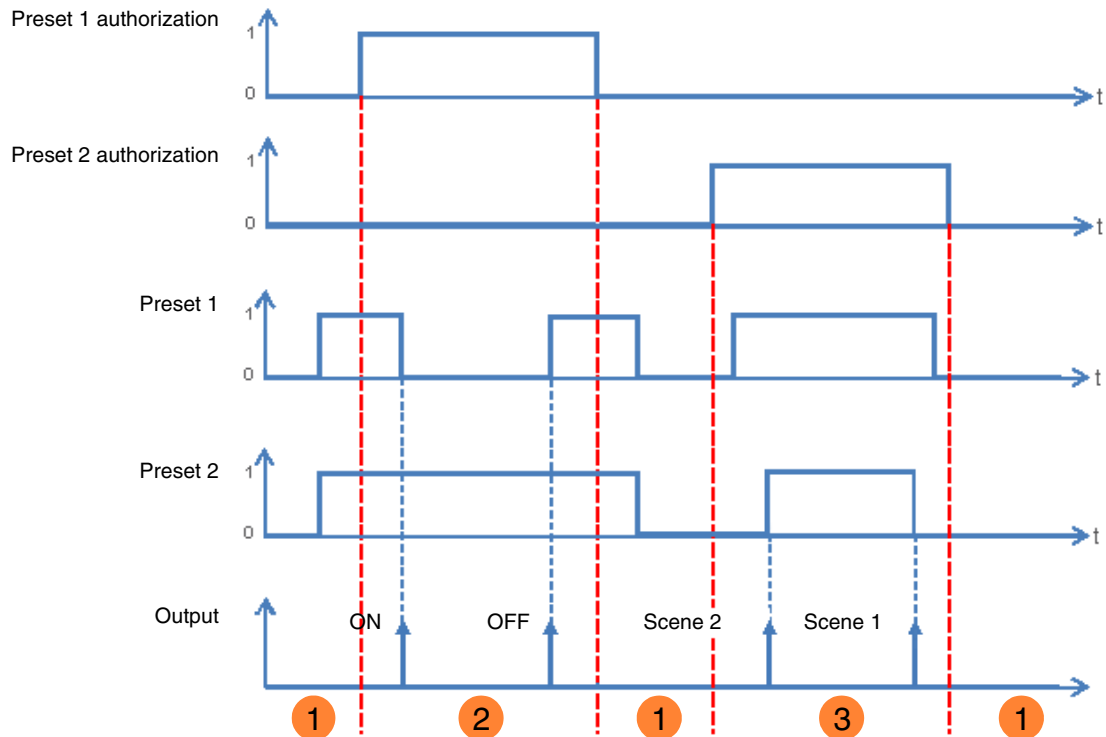

- ❶ The preset inputs have no influence on the output.
- ❷ The commands from Preset 1 are executed.
- ❸ The commands from Preset 2 are executed.

Note: The commands from the Preset will not be executed immediately after authorization, but only when the value of the Preset changes.

Parameter	Description	Value
Preset authorization objects	The Preset 1 authorization communication object and the related parameters are: Hidden. Displayed. This object allows the authorization or lock-up of the Preset 1 function via a KNX telegram.	Not active* Active

Note: The number of available Preset objects is dependent on the **Preset** parameter. A maximum of two of these objects can be available.

Communication objects:

- [9 - Output 1 - Preset 1 authorization \(1 bit - 1.003 DPT_Enable\)](#)
- [41 - Output 2 - Preset 1 authorization \(1 bit - 1.003 DPT_Enable\)](#)
- [73 - Output 3 - Preset 1 authorization \(1 bit - 1.003 DPT_Enable\)](#)
- [105 - Output 4 - Preset 1 authorization \(1 bit - 1.003 DPT_Enable\)](#)
- [137 - Output 5 - Preset 1 authorization \(1 bit - 1.003 DPT_Enable\)](#)
- [169 - Output 6 - Preset 1 authorization \(1 bit - 1.003 DPT_Enable\)](#)

* Default value

Communication objects:

- 10 - Output 1 - Preset 2 authorization** (1 bit - 1.003 DPT_Enable)
- 42 - Output 2 - Preset 2 authorization** (1 bit - 1.003 DPT_Enable)
- 74 - Output 3 - Preset 2 authorization** (1 bit - 1.003 DPT_Enable)
- 106 - Output 4 - Preset 2 authorization** (1 bit - 1.003 DPT_Enable)
- 138 - Output 5 - Preset 2 authorization** (1 bit - 1.003 DPT_Enable)
- 170 - Output 6 - Preset 2 authorization** (1 bit - 1.003 DPT_Enable)

Note: The parameters and objects are identical for Preset 2 ; Only the terms will be adjusted.

Parameter	Description	Value
Value of authorization preset 1 at initialization	On initialization of the device after a download or after return of the bus power, the value of the Preset 1 authorization object is: Set to 0. Set to 1. Set according to the value of the logic input before the initialization occurred.	0 1 Value before initialization*

*Note: This parameter is only visible if the **Preset authorization objects** parameter has the following value: **Active**.*

Parameter	Description	Value
Polarity of autorisation object Preset 1	On receipt of a value on the Preset 1 authorization object, Preset 1 : Locked-up on object value 1. Locked-up on object value 0.	0 = Locked-up, 1 = Authorized* 0 = Authorized, 1 = Locked-up

*Note: This parameter is only visible if the **Preset authorization objects** parameter has the following value: **Active**.*

Parameter	Description	Value
Status if preset 1 object = 0	On receipt of the value 0 on the Preset 1 object, the output is: Not changed. Is switched to the opposite status. Selectively switched on. Selectively switched off. Set to a scene value. Set in blinking mode. Switched to the status that was active before last receiving the value 1 on the Preset 1 object.	Maintain status* Inversion ON OFF Scene number Blinking Status before preset 1 = 1

* Default value

Parameter	Description	Value
Scene for preset 1 = 0	This parameter determines the value of the scene if: The Preset 1 object has value 0. The Status if preset 1 object = 0 object has the scene value.	Scene 1 ... 64 Default value: 1

Parameter	Description	Value
Status if preset 1 object = 1	On receipt of the value 1 on the Preset 1 object, the output is: Not changed. Is switched to the opposite status. Selectively switched on. Selectively switched off. Set to a scene value. Set in blinking mode. Switched to the status that was active before last receiving the value 1 on the Preset 1 object.	Maintain status* Inversion ON OFF Scene number Blinking Status before preset 1 = 0

Parameter	Description	Value
Scene for preset 1 = 1	This parameter determines the value of the scene if: The Preset 1 object has value 1. The Status if preset 1 object = 1 object has the scene value.	Scene 1 ... 64 Default value: Scene 2

Parameter	Description	Value
Blinking ON duration (s)	This parameter determines the closing duration of the output contact when blinking.	5 seconds: 5 to 240 s

*Note: This parameter is only visible if the **Status if preset 1 object = 0** parameter or the **Status if preset 1 object = 1** parameter has the following value: **Blinking**.*

Parameter	Description	Value
Blinking OFF duration (s)	This parameter determines the opening duration of the output contact when blinking.	5 seconds: 5 to 240 s

*Note: This parameter is only visible if the **Status if preset 1 object = 0** parameter or the **Status if preset 1 object = 1** parameter has the following value: **Blinking**.*

Parameter	Description	Value
Output status during blinking function	When the switch actuator is blinking, the Status indication ON/OFF object sends: The value, 1 = ON. The value, 0 = OFF. The values 1 and 0 alternately. (The status object blinks accordingly.)	ON* OFF ON/OFF

*Note: This parameter is only visible if the **Status if preset 1 object = 0** parameter or the **Status if preset 1 object = 1** parameter has the following value: **Blinking**.*

* Default value

3.6.6 Lock-up

Device: 1.1.1 6-fold switch actuator 16A 230V current monitoring

Outputs 1-6: General - O1-6: Manual mode - O1-6: Status indications Output 1: Function selection - O1: Lock-up Output 2: Function selection Output 3: Function selection Output 4: Function selection Output 5: Function selection Output 6: Function selection Information	Lock-up type: Output lock-up Lock-up duration: Permanently Polarity of lock-up object 1: 0 = Lock-up deactivated, 1 = Lock-up activated Polarity of lock-up object 2: 0 = Lock-up deactivated, 1 = Lock-up activated Priority between lock-up 1 and lock-up 2: Lock-up 1 > Lock-up 2 Status if lock-up 1: Maintain status Status if lock-up 2: Maintain status Status after lock-up function 1: Maintain status Status after lock-up function 2: Maintain status Activation of lock-up status object: Active Polarity: 0 = Lock-up deactivated, 1 = Lock-up activated Emission: On status change and periodically Hours (h): 0 Minutes (min): 10 Seconds (s): 0
--	---

The Lock-up function is used to lock the output in a predefined state.
 Priority: Manual mode > Priority > **Lock-up** > Basic function.
 The Lock-up prevents actuation until an unlock command has been received.
 The Lock-up duration can be set.

Parameter	Description	Value
Lock-up type	The Lock-up acts: Directly on the switch actuator. As long as the Lock-up is active, the output can only be controlled by higher priority commands. On selected communication objects. As long as the Lock-up is active, the output can only be controlled via specific selectable objects.	Output lock-up* Object lock-up

Parameter	Description	Value
Lock-up duration	The duration of the Lock-up is Not time limited, the lock-up is only authorized by means of a telegram on Lock-up 1 object. Is active for a limited time, the control of the output is authorized after expiry of this time.	Permanently* Time limited

* Default value

Parameter	Description	Value
Hours (h)	This parameter determines the activation time of the Lock-up.	0 hours: 0 to 23 h
Minutes (min)		15 minutes: 0 to 59 min
Seconds (s)		0 seconds: 0 to 59 s

Note: The smallest executable time is 1 second.

*Note: This parameter is only visible if the **Lock-up duration** parameter has the following value: **Time limited**.*

Parameter	Description	Value
Polarity of lock-up object 1	On receipt of a value on the Lock-up 1 object, the lock-up: Locked-up on object value 1. Is deactivated on object value 0. Locked-up on object value 0. Is deactivated on object value 1.	0 = Lock-up deactivated, 1 = Lock-up activated* 0 = Lock-up activated, 1 = Lock-up deactivated

Note: The parameters and objects are identical for Lock-up 2 ; Only the terms will be adjusted.

Parameter	Description	Value
Priority between lock-up 1 and lock-up 2	The priority between lock-up 1 and lock-up 2 is set as follows: Lock-up 1 has priority over lock-up 2. Lock-up 2 has priority over lock-up 1. Lock-up 1 and lock-up 2 have the same priority.	Lock-up 1 > Lock-up 2* Lock-up 1 < Lock-up 2 Lock-up 1 = Lock-up 2

*Note: This parameter is only visible if the **Lock-up** parameter has the following value: **Active with 2 lock-up objects**.*

Note: The priority of the Lock-up always functions in the same way, independently of the lock-up type (Output lock-up or object lock-up).

* Default value

Operating principle of the priorities:

If Lock-up 1 > Lock-up 2

Active lock-up	Activation order of Lock-up 1	Activation order of Lock-up 2
None	Lock-up 1 is activated	Lock-up 2 is activated
Lock-up 1	Lock-up 1 remains active	Despite the activation order of Lock-up 2, Lock-up 1 remains activated
Lock-up 2	Lock-up 1 is activated	Lock-up 2 remains active

If Lock-up 1 = Lock-up 2

Active lock-up	Activation order of Lock-up 1	Activation order of Lock-up 2
None	Lock-up 1 is activated	Lock-up 2 is activated
Lock-up 1	Lock-up 1 remains active	Lock-up 2 is activated
Lock-up 2	Lock-up 1 is activated	Lock-up 2 remains active

If Lock-up 1 < Lock-up 2

Active lock-up	Activation order of Lock-up 1	Activation order of Lock-up 2
None	Lock-up 1 is activated	Lock-up 2 is activated
Lock-up 1	Lock-up 1 remains active	Lock-up 2 is activated
Lock-up 2	Despite the activation order of Lock-up 1, Lock-up 2 remains activated	Lock-up 2 remains active

Parameter	Description	Value
Status if lock-up 1	If the Lock-up type is set to Output lock-up , on activation of the lock-up the output will: Not changed. Is switched to the opposite status. Selectively switched on. Selectively switched off.	Maintain status* Inversion ON OFF

Note: The parameters and objects are identical for Lock-up 2 ; Only the terms will be adjusted.

Lock-up 1 authorizes object:

The parameters listed below allow the selection of the objects for controlling the output via the nevertheless active Lock-up.

*Note: These parameters are only visible if the **Lock-up type** parameter has the following value: **Object lock-up**.*

* Default value

Parameter	Objects concerned	Value
ON/OFF	ON/OFF	Yes No*
Scene	Scene	Yes No*
Timer	Timer	Yes No*
Timer/toggle switch changeover	Timer/toggle switch changeover	Yes No*
Time limited toggle switch	Time limited toggle switch object	Yes No*
Preset 1	Preset 1	Yes No*
Preset 2	Preset 2	Yes No*

Note: The parameters and objects are identical for Lock-up 2 ; Only the terms will be adjusted.

Parameter	Description	Value
Status after lock-up function 1	<p>If the Lock-up type is set to Output lock-up, on cancellation of the lock-up the output will:</p> <p>Not changed.</p> <p>Is switched to the opposite status.</p> <p>Selectively switched on.</p> <p>Selectively switched off.</p> <p>Return to the status that was active before the lock-up.</p>	<p>Maintain status*</p> <p>Inversion</p> <p>ON</p> <p>OFF</p> <p>Status before lock-up 1</p>

Note: The application of this parameter depends on the priority of the other active functions. If a function with higher priority is active, this parameter will not be enacted. In the case where two functions with the same priority are active, the parameter of the most recently switched off function is enacted.

Note: The parameters and objects are identical for Lock-up 2 ; Only the terms will be adjusted.

Parameter	Description	Value
Activation of lock-up status object	<p>The Status indication lock-up communication object is hidden.</p> <p>The Status indication lock-up communication object is displayed.</p>	<p>Not active*</p> <p>Active</p>

Communication objects:

- [13 - Output 1 - Status indication lock-up \(1 bit - 1.011 DPT_State\)](#)
- [45 - Output 2 - Status indication lock-up \(1 bit - 1.011 DPT_State\)](#)
- [77 - Output 3 - Status indication lock-up \(1 bit - 1.011 DPT_State\)](#)
- [109 - Output 4 - Status indication lock-up \(1 bit - 1.011 DPT_State\)](#)
- [141 - Output 5 - Status indication lock-up \(1 bit - 1.011 DPT_State\)](#)
- [173 - Output 6 - Status indication lock-up \(1 bit - 1.011 DPT_State\)](#)

* Default value

Parameter	Description	Value
Polarity	The Status indication Lock-up communication object sends: 0 on deactivation of the lock-up. 1 on activation of the lock-up. 0 on activation of the lock-up. 1 on deactivation of the lock-up.	0 = Lock-up deactivated, 1 = Lock-up activated* 0 = Lock-up activated, 1 = Lock-up deactivated

Parameter	Description	Value
Emission	The Status indication lock-up communication object is sent: On activation and deactivation of the lock-up. Periodically after a configurable time. On activation and deactivation of the lock-up and periodically after a configurable time.	On status change* Periodically On status change and periodically

Note: This parameter is only visible if the **Activation of Lock-up status object** parameter has the following value: **Active**.

Parameter	Description	Value
Hours (h)	This parameter determines the time between the individual transmissions of the Status indication lock-up object.	0 hours: 0 to 23 h
Minutes (min)		10 minutes: 0 to 59 min
Seconds (s)		0 seconds: 0 to 59 s

Note: The smallest executable time is 1 second.

Note: This parameter is only visible if the **Emission** parameter has the following value: **Periodically** or **On status change and periodically**.

3.6.7 Priority

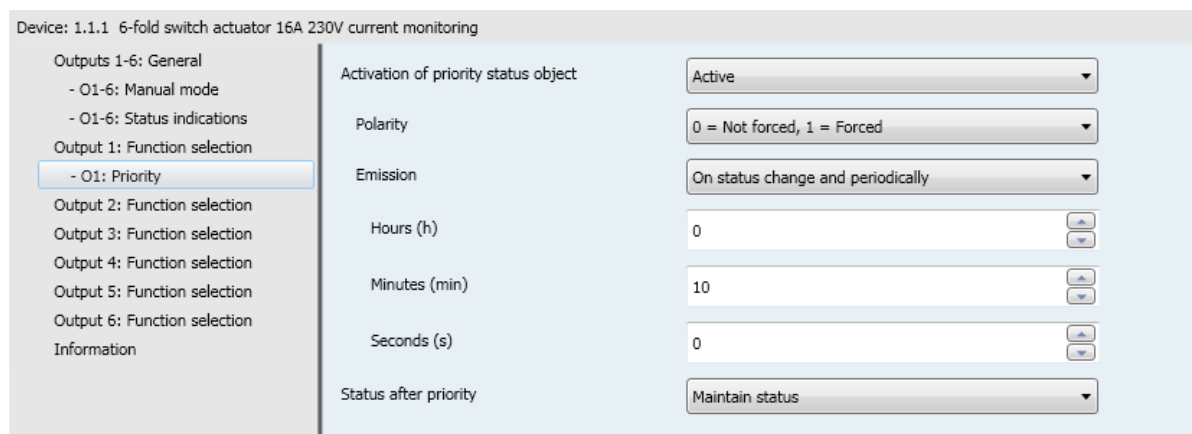

The Priority is used to force the output into a predefined state.

Priority: Manual mode > **Priority** > Lock-up > Basic function.

No other command is taken into account when the Priority is active. Only by ending the Priority are other commands again permitted.

* Default value

Parameter	Description	Value
Activation of priority status object	The Status indication priority communication object and related parameters are hidden.	Not active*
	The Status indication priority communication object and related parameters are displayed.	Active

Communication objects:

- [15 - Output 1 - Status indication priority \(1 bit - 1.011 DPT_State\)](#)
- [47 - Output 2 - Status indication priority \(1 bit - 1.011 DPT_State\)](#)
- [79 - Output 3 - Status indication priority \(1 bit - 1.011 DPT_State\)](#)
- [111 - Output 4 - Status indication priority \(1 bit - 1.011 DPT_State\)](#)
- [143 - Output 5 - Status indication priority \(1 bit - 1.011 DPT_State\)](#)
- [176 - Output 6 - Status indication priority \(1 bit - 1.011 DPT_State\)](#)

Parameter	Description	Value
Polarity	The Status indication priority communication object sends: 0 on deactivation of the Priority. 1 on activation of the Priority. 0 on activation of the Priority. 1 on deactivation of the Priority.	0 = Not forced, 1 = Forced* 0 = Forced, 1 = Not forced

Note: This parameter is only visible if the **Activation of priority status object** parameter has the following value: **Active**.

Parameter	Description	Value
Emission	The Status indication priority communication object is sent: On activation and deactivation of the Priority. Periodically after a configurable time. On activation and deactivation of the Priority and periodically after a configurable time.	On status change* Periodically On status change and periodically

Note: This parameter is only visible if the **Activation of priority status object** parameter has the following value: **Active**.

Parameter	Description	Value
Hours (h)	This parameter determines the time between the individual transmissions of the Status indication priority object.	0 hours: 0 to 23 h
Minutes (min)		10 minutes: 0 to 59 min
Seconds (s)		0 seconds: 0 to 59 s

Note: The smallest executable time is 1 second.

Note: This parameter is only visible if the **Emission** parameter has the following value: **Periodically** or **On status change and periodically**.

* Default value

Parameter	Description	Value
Status after priority	At the end of the priority, the output is: Not changed. Is switched to the opposite status. Selectively switched on. Selectively switched off. Switched back to the status before priority was activated. Switched to the status which would be active according to other communication objects if the priority had not taken place.	Maintain status* Inversion ON OFF Status before priority Theoretical status without priority

Note: The application of this parameter depends on the priority of the other active functions. If a function with higher priority is active, this parameter will not be enacted. In the case where two functions with the same priority are active, the parameter of the most recently switched off function is enacted.

3.6.8 Hours counter

The Hours Counter function is used to count the overall operating time of an output in the ON or OFF state. The operating hours counter setpoint can be programmed and altered via an object.

Device: 1.1.1 6-fold switch actuator 16A 230V current monitoring

- Outputs 1-6: General
 - O1-6: Manual mode
 - O1-6: Status indications
- Output 1: Function selection
 - O1: Hours counter
- Output 2: Function selection
- Output 3: Function selection
- Output 4: Function selection
- Output 5: Function selection
- Output 6: Function selection
- Information

Relay status for operating hours counter: Closed

Hours counter direction: Increment

Operating h. counter setpoint: 10000

Counter setpoint value modifiable through object: Not active

Emission hours counter value: On status change and periodically

Value interval (h): 100

Periodical emission delay (h): 1

Periodical emission delay (min): 0

Periodical emission delay (s): 0

Object emission counter setpoint reached: Periodically

Periodical emission delay (h): 1

Periodical emission delay (min): 0

Periodical emission delay (s): 0

Parameter	Description	Value
Relay status for operating hours counter	The hours counter runs if: The output is closed. The output is open.	Closed* Opened

* Default value

Parameter	Description	Value
Hours counter direction	The hours counter counts: Growing. Decreasing.	Increment* Countdown

Increment:

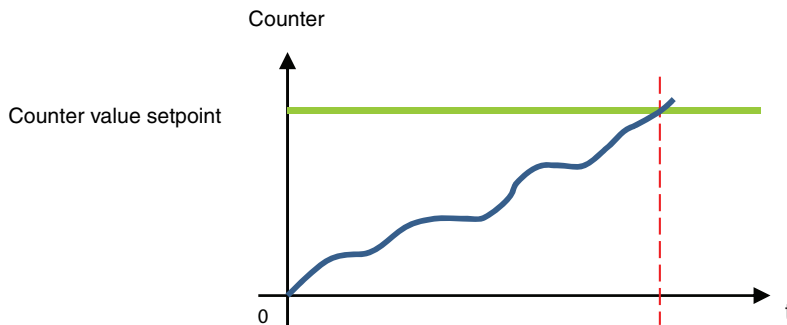

The counter starts to count up from the value 0. As soon as the counter setpoint (**Hours counter setpoint** object) is reached, the **Hours counter setpoint reached** object is set to 1 and sent to the bus.

Countdown:

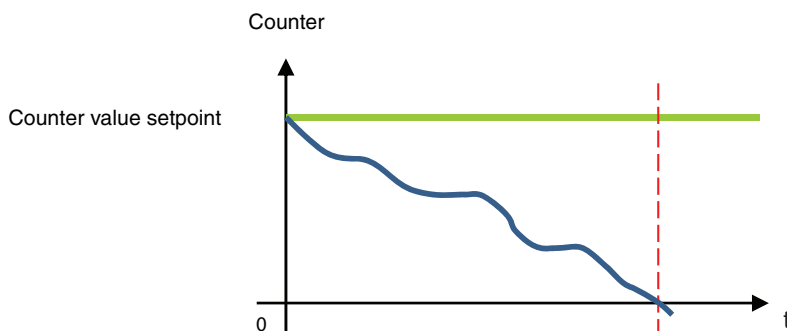

The counter starts to count down from the operating hours counter setpoint (**Hours counter setpoint** object). As soon as the counter reaches 0, the **Hours counter setpoint reached** is set to 1 and sent to the bus.

Parameter	Description	Value
Hours counter setpoint	This parameter determines the value of the hours counter.	1 ... 10000* ... 65535

An incrementing counter starts at 0 and counts up until it reaches the setpoint value.

A countdown counter starts to count at the setpoint value and counts down until it has arrived at 0.

Parameter	Description	Value
Counter setpoint value modifiable through object	The Hours counter setpoint communication object is hidden. The Hours counter setpoint communication object is displayed. The value can be changed via the KNX bus.	Not active* Active

* Default value

- Communication objects:
- 19 - Output 1 - Hours counter setpoint** (2 byte - 7.001 DPT_16_bit_Counter)
 - 51 - Output 2 - Hours counter setpoint** (2 byte - 7.001 DPT_16_bit_Counter)
 - 83 - Output 3 - Hours counter setpoint** (2 byte - 7.001 DPT_16_bit_Counter)
 - 115 - Output 4 - Hours counter setpoint** (2 byte - 7.001 DPT_16_bit_Counter)
 - 147 - Output 5 - Hours counter setpoint** (2 byte - 7.001 DPT_16_bit_Counter)
 - 180 - Output 6 - Hours counter setpoint** (2 byte - 7.001 DPT_16_bit_Counter)

Parameter	Description	Value
Emission hours counter value	The Hours counter value communication object is sent: On each change. Periodically after a configurable time. On change and periodically after a configurable time.	On status change* Periodically On status change and periodically

Parameter	Description	Value
Value interval (h)	This parameter specifies the value interval (in hours) for the sending frequency of the Hours counter setpoint object.	1 ... 100* ... 65535 (hours)

*Note: If the value interval is 200 hours, then the **Hours counter setpoint** object is sent each time the Operating h. counter value is increased by 200 hours.*

*Note: This parameter is only visible if the **Emission hours counter value** parameter has the following value: **Periodically** or **On status change and periodically**.*

Parameter	Description	Value
Periodical emission delay	This parameter determines the time between the individual transmissions of the Hours counter setpoint object.	1 hours: 0 to 23 h 0 minutes: 0 to 59 min 0 seconds: 0 to 59 s

Note: The smallest executable time is 1 second.

*Note: This parameter is only visible if the **Emission hours counter value** parameter has the following value: **Periodically** or **On status change and periodically**.*

Parameter	Description	Value
Object emission counter setpoint reached	The Hours counter setpoint reached communication object is sent: On reaching the counter setpoint. Periodically after a configurable time. On reaching the counter setpoint and periodically after a configurable time.	On status change Periodically* On status change and periodically

Parameter	Description	Value
Periodical emission delay	This parameter determines the time between the individual transmissions of the Hours counter setpoint reached object.	1 hours: 0 to 23 h 0 minutes: 0 to 59 min 0 seconds: 0 to 59 s

Note: The smallest executable time is 1 second.

*Note: This parameter is only visible if the Object **Emission counter setpoint reached** parameter has the following value: **Periodically** or **On status change and periodically**.*

* Default value

3.6.9 Current detection

The following applications, for example, can be covered by the Current detection function:

- Visualization of effective currents.
- Monitoring of power consumption setpoints.
- Error detection.

This information is sent periodically and/or on a change of status.

3.6.9.1 Output current detection delay after switching

Device: 1.1.1 6-fold switch actuator 16A 230V current monitoring

<ul style="list-style-type: none"> Outputs 1-6: General <ul style="list-style-type: none"> - O1-6: Manual mode - O1-6: Status indications Output 1: Function selection <ul style="list-style-type: none"> - O1: Current detection Output 2: Function selection Output 3: Function selection Output 4: Function selection Output 5: Function selection Output 6: Function selection Information 	<p>Output current detection delay after switching: Active</p> <p>Minutes (min): 0</p> <p>Seconds (s): 3</p> <p>Switching validation: Not active</p> <p>Current setpoint monitoring: Not active</p> <p>No current flow detection: Not active</p> <p>Switching counter: Not active</p> <p>Emission current value: Not active</p> <p>Current det. in open contacts: Not active</p>
---	---

So that no false status or value is sent to the KNX bus during switching of the output contact (current pulse), the current detection can be started following a delay after switching.

Parameter	Description	Value
Output current detection delay after switching	The parameters for delaying the current measurement are: Hidden. Displayed.	Not active* Active

* Default value

During this delay, the measured current value is 0 mA.

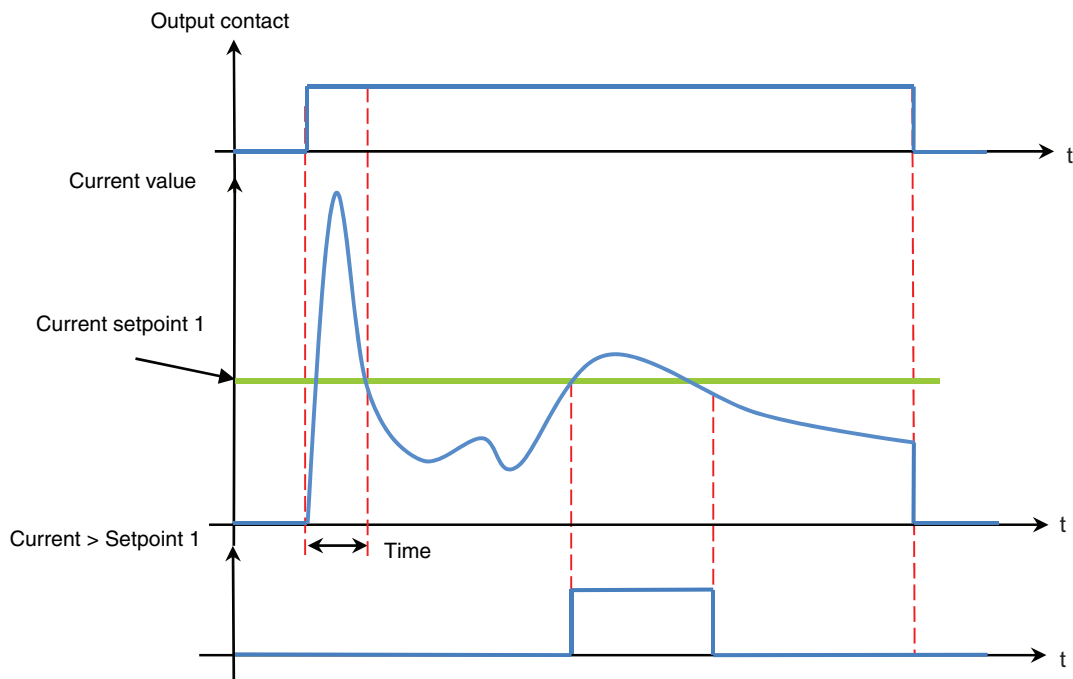

Parameter	Description	Value
Minutes (min)	This parameter determines the time delay after which the current measurement is made, when switching the output contacts.	0 minutes: 0 to 59 min
Seconds (s)		3 seconds: 0 to 59 s

*Note: This parameter is only visible if the **Output current detection delay after switching** parameter has the following value: **Active**.*

3.6.9.2 Switching validation via current measurement

The screenshot shows the configuration interface for a 'Device: 1.1.1 6-fold switch actuator 16A 230V current monitoring'. The left sidebar lists various output functions, with '- O1: Current detection' selected. The main configuration area contains several parameters:

- Output current detection delay after switching: Not active
- Switching validation: Active
- Current setpoint for switch validation (mA): 20
- Current setpoint monitoring: Not active
- No current flow detection: Not active
- Switching counter: Not active
- Emission current value: Not active
- Current det. in open contacts: Not active

The present Status indication is that transferred on the KNX bus, the image of the telegram that is entered to control the output. If a device or a relay is defective, the status submitted to the KNX bus is not the actual status of the device. By measuring the current flowing through the output, the status indication provides the image of the actual status of the output contact.

* Default value

Parameter	Description	Value
Switching validation	<p>The dependence of the Status indication object on an actual current measurement is</p> <p>Not active, the associated parameters are hidden.</p> <p>Active, the associated parameters are displayed.</p>	<p>Not active*</p> <p>Active</p>

Parameter	Description	Value
Current setpoint for switch validation (mA)	<p>This parameter determines the current consumption setpoint above which the device at the output is considered to be switched on.</p> <p>At this limiting value, the Status indication ON/OFF object has the value 1. Otherwise, the value is 0.</p>	<p>20* ... 500 mA</p>

*Note: If the setpoint value of the current is 100 mA, the **Status indication ON/OFF** object has the value 1 if the device consumes more than 100 mA or 0 if the device consumes less than 100 mA.*

*Note: This parameter is only visible if the **Switching validation** parameter has the following value: **Active**.*

* Default value

3.6.9.3 Current setpoint monitoring

Device: 1.1.1 6-fold switch actuator 16A 230V current monitoring

<ul style="list-style-type: none"> Outputs 1-6: General <ul style="list-style-type: none"> - O1-6: Manual mode - O1-6: Status indications Output 1: Function selection <ul style="list-style-type: none"> - O1: Current detection Output 2: Function selection Output 3: Function selection Output 4: Function selection Output 5: Function selection Output 6: Function selection Information 	<p>Output current detection delay after switching Not active</p> <p>Switching validation Not active</p> <p>Current setpoint monitoring 2 setpoints current monitoring</p> <p>Current setpoint 1 (mA) 10000</p> <p>Positive current setpoint 1 hysteresis 50</p> <p>Negative current setpoint 1 hysteresis 50</p> <p>Current setpoint 1 modifiable through object Not active</p> <p>Current setpoint 2 (mA) 100</p> <p>Positive current setpoint 2 hysteresis 50</p> <p>Negative current setpoint 2 hysteresis 50</p> <p>Current setpoint 2 modifiable through object Not active</p> <p>Acquisition time for notification after setpoint cross (h) 0</p> <p>Acquisition time for notification after setpoint cross (min) 1</p> <p>Acquisition time for notification after setpoint cross (s) 0</p> <p>Polarity of current over setpoint 1 object 0 = Current < Setpoint 1, 1 = Current > Setpoint 1</p> <p>Polarity of current between setpoint 1 and 2 object 0 = Current not betw.SP1&2, 1 = Current betw.SP1&2</p> <p>Polarity of current under setpoint 2 object 0 = Current > Setpoint 2, 1 = Current < Setpoint 2</p> <p>Emission of current setpoint crossing object On status change</p>
---	---

This function is used for notification of the exceeding of one or more configurable output current setpoints.

There are 2 possibilities:

- 1 setpoint current monitoring: This function is used for notification of the exceeding of one output current setpoint. This setpoint and the associated hysteresis can be set.

* Default value

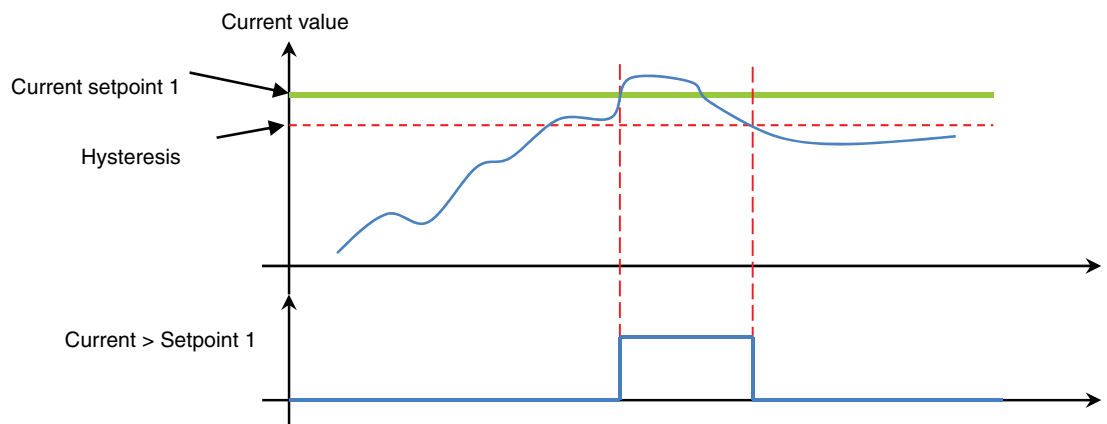

- 2 setpoints current monitoring: This function is used for notification of the exceeding of an upper and a lower output current setpoint. These setpoints and their associated hysteresis can be set.

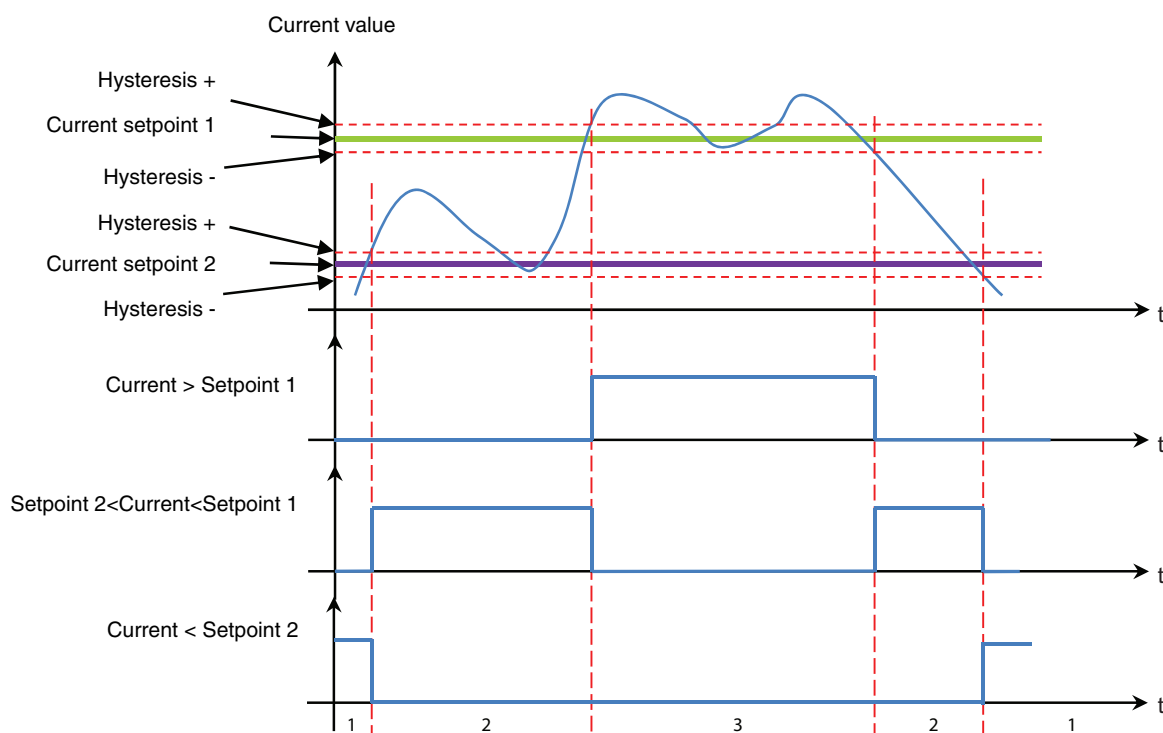

Parameter	Description	Value
Current setpoint monitoring	Current setpoint monitoring is: Not active, the associated parameters are hidden. Active as 1 setpoint current monitoring. Active as 2 setpoints current monitoring.	Not active* 1 setpoint current monitoring 2 setpoints current monitoring

Note: When the value of this parameter changes, the associated parameters and group addresses are deleted.

* Default value

Communication objects:

- 22 - Output 1 - Current > Setpoint 1 (1 bit - 1.011 DPT_State)
- 54 - Output 2 - Current > Setpoint 1 (1 bit - 1.011 DPT_State)
- 86 - Output 3 - Current > Setpoint 1 (1 bit - 1.011 DPT_State)
- 118 - Output 4 - Current > Setpoint 1 (1 bit - 1.011 DPT_State)
- 150 - Output 5 - Current > Setpoint 1 (1 bit - 1.011 DPT_State)
- 183 - Output 6 - Current > Setpoint 1 (1 bit - 1.011 DPT_State)

Communication objects:

- 23 - Output 1 - Setpoint 2<Current<Setpoint 1 (1 bit - 1.011 DPT_State)
- 55 - Output 2 - Setpoint 2<Current<Setpoint 1 (1 bit - 1.011 DPT_State)
- 87 - Output 3 - Setpoint 2<Current<Setpoint 1 (1 bit - 1.011 DPT_State)
- 119 - Output 4 - Setpoint 2<Current<Setpoint 1 (1 bit - 1.011 DPT_State)
- 151 - Output 5 - Setpoint 2<Current<Setpoint 1 (1 bit - 1.011 DPT_State)
- 184 - Output 6 - Setpoint 2<Current<Setpoint 1 (1 bit - 1.011 DPT_State)
- 24 - Output 1 - Current < Setpoint 2 (1 bit - 1.011 DPT_State)
- 56 - Output 2 - Current < Setpoint 2 (1 bit - 1.011 DPT_State)
- 88 - Output 3 - Current < Setpoint 2 (1 bit - 1.011 DPT_State)
- 120 - Output 4 - Current < Setpoint 2 (1 bit - 1.011 DPT_State)
- 152 - Output 5 - Current < Setpoint 2 (1 bit - 1.011 DPT_State)
- 186 - Output 6 - Current < Setpoint 2 (1 bit - 1.011 DPT_State)

Parameter	Description	Value
Current setpoint 1 (mA)	This parameter determines the value of Current setpoint 1.	20 ... 10000* ... 16000 mA

*Note: This parameter is only visible if the **Current setpoint monitoring** parameter has the following value: **2 setpoints current monitoring** or **1 setpoint current monitoring**.*

Parameter	Description	Value
Positive current setpoint 1 hysteresis	This parameter determines the upper hysteresis value for Current setpoint 1.	50* ... 5000 mA

*Note: This parameter is only visible if the **Current setpoint monitoring** parameter has the following value: **2 setpoints current monitoring**.*

Parameter	Description	Value
Negative current setpoint 1 hysteresis	This parameter determines the lower hysteresis value for Current setpoint 1.	50* ... 5000 mA

*Note: This parameter is only visible if the **Current setpoint monitoring** parameter has the following value: **2 setpoints current monitoring** or **1 setpoint current monitoring**.*

* Default value

Parameter	Description	Value
Current setpoint 1 modifiable through object	Via the Current setpoint 1 communication object, Current setpoint 1 is: Not changed, received values are discarded. Changed, received values are accepted as a new Current setpoint.	Not active* Active

*Note: This parameter is only visible if the **Current setpoint monitoring** parameter has the following value: **2 setpoints current monitoring** or **1 setpoint current monitoring**.*

Communication objects:

- [20 - Output 1 - Current setpoint 1](#) (2 byte - 7.012 DPT_UEICurrentmA)
- [52 - Output 2 - Current setpoint 1](#) (2 byte - 7.012 DPT_UEICurrentmA)
- [84 - Output 3 - Current setpoint 1](#) (2 byte - 7.012 DPT_UEICurrentmA)
- [116 - Output 4 - Current setpoint 1](#) (2 byte - 7.012 DPT_UEICurrentmA)
- [148 - Output 5 - Current setpoint 1](#) (2 byte - 7.012 DPT_UEICurrentmA)
- [181 - Output 6 - Current setpoint 1](#) (2 byte - 7.012 DPT_UEICurrentmA)

Parameter	Description	Value
Current setpoint 2 (mA)	This parameter determines the value of Current setpoint 2.	20 ... 100* ... 16000 mA

*Note: This parameter is only visible if the **Current setpoint monitoring** parameter has the following value: **2 setpoints current monitoring**.*

Parameter	Description	Value
Positive current setpoint 2 hysteresis	This parameter determines the upper hysteresis value for Current setpoint 2.	50* ... 5000 mA

*Note: This parameter is only visible if the **Current setpoint monitoring** parameter has the following value: **2 setpoints current monitoring**.*

Parameter	Description	Value
Negative current setpoint 2 hysteresis	This parameter determines the lower hysteresis value for Current setpoint 2.	50* ... 5000 mA

*Note: This parameter is only visible if the **Current setpoint monitoring** parameter has the following value: **2 setpoints current monitoring**.*

Parameter	Description	Value
Current setpoint 2 modifiable through object	Via the Current setpoint 2 communication object, Current setpoint 2 is: Not changed, received values are discarded. Changed, received values are accepted as a new Current setpoint.	Not active* Active

*Note: This parameter is only visible if the **Current setpoint monitoring** parameter has the following value: **2 setpoints current monitoring**.*

* Default value

- Communication objects:
- 21 - Output 1 - Current setpoint 2** (2 byte - 7.012 DPT_UEICurrentmA)
 - 53 - Output 2 - Current setpoint 2** (2 byte - 7.012 DPT_UEICurrentmA)
 - 85 - Output 3 - Current setpoint 2** (2 byte - 7.012 DPT_UEICurrentmA)
 - 117 - Output 4 - Current setpoint 2** (2 byte - 7.012 DPT_UEICurrentmA)
 - 149 - Output 5 - Current setpoint 2** (2 byte - 7.012 DPT_UEICurrentmA)
 - 182 - Output 6 - Current setpoint 2** (2 byte - 7.012 DPT_UEICurrentmA)

Parameter	Description	Value
Acquisition time for notification after setpoint cross	This parameter determines the delay after which the object Current > Setpoint 1 Setpoint 2 < Current < Setpoint 1 Current < Setpoint 2 is sent to the bus KNX.	0 hours: 0 to 23 h 1 minutes: 0 to 59 min 0 seconds: 0 to 59 s

*Note: This parameter is only visible if the **Current setpoint monitoring** parameter has the following value: **2 setpoints current monitoring** or **1 setpoint current monitoring**.*

Parameter	Description	Value
Polarity of current over setpoint 1 object	The Current > Setpoint 1 communication object sends: 0 if current is less than Setpoint 1. 1 if current is greater than Setpoint 1. 0 if current is greater than Setpoint 1. 1 if current is less than Setpoint 1.	0 = Current < Setpoint 1, 1 = Current > Setpoint 1* 0 = Current > Setpoint 1, 1 = Current < Setpoint 1

*Note: The status change of the **Current > Setpoint 1** object is also dependent on the hysteresis value of Current setpoint 1.
 Note: This parameter is only visible if the **Current setpoint monitoring** parameter has the following value: **2 setpoints current monitoring** or **1 setpoint current monitoring**.*

Parameter	Description	Value
Polarity of current between setpoint 1 and 2 object	The Setpoint 2 < Current < Setpoint 1 communication object sends: 0 if the current is between setpoint 1 and 2. 1 if the current is not between setpoint 1 and 2. 0 if the current is not between setpoint 1 and 2. 1 if the current is between setpoint 1 and 2.	0 = Current betw.SP 1&2, 1 = Current not betw.SP 1&2 0 = Current not betw.SP 1&2, 1 = Current betw.SP 1&2*

*Note: The status change of the **Setpoint 2 < Current < Setpoint 1** object is also dependent on the value of the hysteresis of Current setpoint 1 and Current setpoint 2.
 Note: This parameter is only visible if the **Current setpoint monitoring** parameter has the following value: **2 setpoints current monitoring**.*

Parameter	Description	Value
Polarity of current under setpoint 2 object	The Current < Setpoint 2 communication object sends: 0 if current is greater than Setpoint 2. 1 if current is less than Setpoint 2. 0 if current is less than Setpoint 2. 1 if current is greater than Setpoint 2.	0 = Current > Setpoint 2, 1 = Current < Setpoint 2* 0 = Current > Setpoint 2, 1 = Current < Setpoint 2

*Note: The status change of the **Current < Setpoint 2** object is also dependent on the hysteresis value of Current setpoint 2.
 Note: This parameter is only visible if the **Current setpoint monitoring** parameter has the following value: **2 setpoints current monitoring**.*

* Default value

Parameter	Description	Value
Emission of current setpoint crossing object	The Setpoint monitoring communication object is sent: On reaching the counter setpoint. Periodically after a configurable time. On reaching the counter setpoint and periodically after a configurable time.	On status change* Periodically On status change and periodically

Parameter	Description	Value
Hours (h)	This parameter determines the time between the individual transmissions of the Setpoint monitoring object.	1 hours: 0 to 23 h
Minutes (min)		0 minutes: 0 to 59 min
Seconds (s)		0 seconds: 0 to 59 s

Note: This parameter is only visible if the **Emission of current setpoint crossing object** parameter has the following value: **Periodically** or **On status change and periodically**.

3.6.9.4 No current flow detection

Device: 1.1.1 6-fold switch actuator 16A 230V current monitoring

- Outputs 1-6: General
 - O1-6: Manual mode
 - O1-6: Status indications
- Output 1: Function selection
 - O1: Current detection
- Output 2: Function selection
- Output 3: Function selection
- Output 4: Function selection
- Output 5: Function selection
- Output 6: Function selection
- Information

Output current detection delay after switching	Not active
Switching validation	Not active
Current setpoint monitoring	Not active
No current flow detection	Active
Acquisition time for notification no current flow detection (h)	0
Acquisition time for notification no current flow detection (min)	1
Acquisition time for notification no current flow detection (s)	0
Polarity of no current flow detection object	0 = No current stop detect., 1 = Current stop det.
Emission of no current flow detection object	On status change
Switching counter	Not active
Emission current value	Not active
Current det. in open contacts	Not active

This function is used for notification of a zero current consumption for a given period with closed output contact. Example: Detection of a fault in the power supply to a refrigerator or an aquarium pump.

* Default value

Parameter	Description	Value
No current flow detection	The No current flow detection communication object and its parameters are hidden.	Not active*
	The No current flow detection communication object and its parameters are displayed.	Active

Communication objects:

- [25 - Output 1 - No current flow detection](#) (1 bit - 1.011 DPT_State)
- [57 - Output 2 - No current flow detection](#) (1 bit - 1.011 DPT_State)
- [89 - Output 3 - No current flow detection](#) (1 bit - 1.011 DPT_State)
- [121 - Output 4 - No current flow detection](#) (1 bit - 1.011 DPT_State)
- [153 - Output 5 - No current flow detection](#) (1 bit - 1.011 DPT_State)
- [186 - Output 6 - No current flow detection](#) (1 bit - 1.011 DPT_State)

Parameter	Description	Value
Acquisition time for notification no current flow detection	This parameter determines the time between the individual transmissions of the No current flow detection object.	0 hours: 0 to 23 h 1 minutes: 0 to 59 min 0 seconds: 0 to 59 s

*Note: This parameter is only visible if the **No current flow** detection parameter has the following value: **Active**.*

Parameter	Description	Value
Polarity of no current flow detection object	The No current flow detection communication object sends: 0 if current flow is detected on closed output. 1 if no current flow detected on closed output. 0 if no current flow detected on closed output. 1 if current flow is detected on closed output.	0 = No current stop detect, 1 = Current stop det* 0 = Current stop det, 1 = No current stop detect

*Note: The delay for notification of **No current flow** detection is taken into account.*

*Note: This parameter is only visible if the **No current flow** detection parameter has the following value: **Active**.*

Parameter	Description	Value
Emission of no current flow detection object	The No current flow detection communication object is sent: On each change. Periodically after a configurable time. On change and periodically after a configurable time.	On status change* Periodically On status change and periodically

* Default value

Parameter	Description	Value
Hours (h)	This parameter determines the time between the individual transmissions of the No current flow detection object.	6 hours: 0 to 23 h
Minutes (min)		0 minutes: 0 to 59 min
Seconds (s)		0 seconds: 0 to 59 s

Note: This parameter is only visible if the **Emission of no current flow detection object** parameter has the following value: **Periodically** or **On status change and periodically**.

3.6.9.5 Switching counter

Device: 1.1.1 6-fold switch actuator 16A 230V current monitoring

Outputs 1-6: General

- O1-6: Manual mode
- O1-6: Status indications

Output 1: Function selection

- O1: Current detection

Output 2: Function selection

Output 3: Function selection

Output 4: Function selection

Output 5: Function selection

Output 6: Function selection

Information

Output current detection delay after switching		Not active
Switching validation		Not active
Current setpoint monitoring		Not active
No current flow detection		Not active
Switching counter		Active
Status changeover for counter		Open --> Closed
Hours counter direction		Increment
Counter value setpoint		10000
Counter setpoint value modifiable through object		Not active
Counter value emission		On status change
Value interval (switchings)		100
Object emission counter setpoint reached		On status change
Emission current value		Not active
Current det. in open contacts		Not active

The Switching counter function is used to measure switching from On to Off and from Off to On for each output. This value is transmitted via the **Switching counter value** object.

Parameter	Description	Value
Switching counter	The Switching counter's communication objects and its parameters are hidden.	Not active*
	The Switching counter's communication objects and its parameters are displayed.	Active

A telegram can be transmitted via the **Counter setpoint reached** object, in accordance with a programmable setpoint. It is also possible to reset the counter value via the **Reset switching counter value** object.

* Default value

Communication objects:

- 26 - Output 1 - Switching counter value (2 byte - 7.001 DPT_Value_2_Ucount)
- 58 - Output 2 - Switching counter value (2 byte - 7.001 DPT_Value_2_Ucount)
- 90 - Output 3 - Switching counter value (2 byte - 7.001 DPT_Value_2_Ucount)
- 122 - Output 4 - Switching counter value (2 byte - 7.001 DPT_Value_2_Ucount)
- 154 - Output 5 - Switching counter value (2 byte - 7.001 DPT_Value_2_Ucount)
- 187 - Output 6 - Switching counter value (2 byte - 7.001 DPT_Value_2_Ucount)

- 27 - Output 1 - Reset op. switching cntr value (1 bit - 1.015 DPT_Reset)
- 59 - Output 2 - Reset op. switching cntr value (1 bit - 1.015 DPT_Reset)
- 91 - Output 3 - Reset op. switching cntr value (1 bit - 1.015 DPT_Reset)
- 123 - Output 4 - Reset op. switching cntr value (1 bit - 1.015 DPT_Reset)
- 155 - Output 5 - Reset op. switching cntr value (1 bit - 1.015 DPT_Reset)
- 186 - Output 6 - Reset op. switching cntr value (1 bit - 1.015 DPT_Reset)

- 28 - Output 1 - Switching cntr setpt. reached (1 bit - 1.011 DPT_State)
- 60 - Output 2 - Switching cntr setpt. reached (1 bit - 1.011 DPT_State)
- 92 - Output 3 - Switching cntr setpt. reached (1 bit - 1.011 DPT_State)
- 124 - Output 4 - Switching cntr setpt. reached (1 bit - 1.011 DPT_State)
- 156 - Output 5 - Switching cntr setpt. reached (1 bit - 1.011 DPT_State)
- 187 - Output 6 - Switching cntr setpt. reached (1 bit - 1.011 DPT_State)

Parameter	Description	Value
Status changeover for counter	The Switching counter counts: The changes from opened to closed. The changes from closed to open. Each change of state.	Open --> Closed* Closed --> Open Open --> Closed and Closed --> Open

Parameter	Description	Value
Hours counter direction	The Switching counter: Growing. Decreasing.	Increment* Countdown

* Default value

Increment:

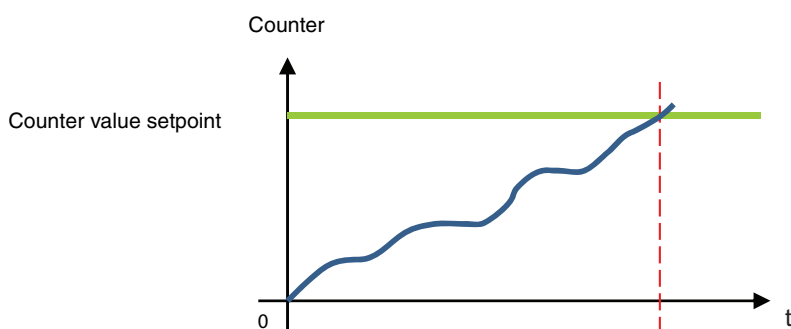

The counter starts to count up from the value 0. As soon as the counter setpoint (**Switching counter setpoint** object) is reached, the **Switching cntr setpt. reached** object is set to 1 and sent to the bus.

Countdown:

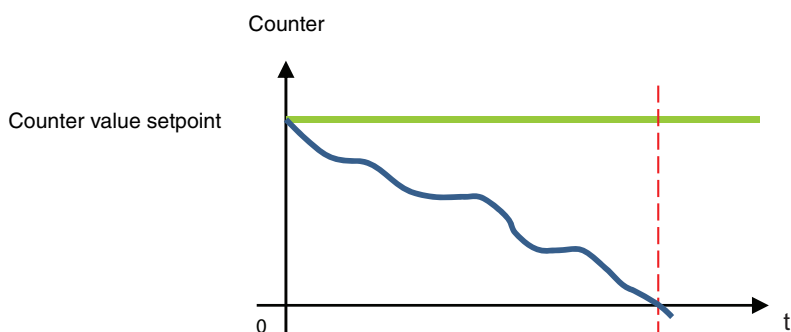

The counter starts to count down from the counter setpoint (**Switching counter setpoint** object). As soon as the counter reaches 0, the **Switching cntr setpt. reached** object is set to 1 and sent to the bus.

Parameter	Description	Value
Counter value setpoint	This parameter determines the setpoint for the Switching counter of the output contacts.	1 ... 10000* ... 65535

An incrementing counter starts at 0 and counts up until it reaches the setpoint value.
 A countdown counter starts to count at the setpoint value and counts down until it has arrived at 0.

Parameter	Description	Value
Switching counter setpoint value modifiable through object	The Switching counter setpoint communication object is: Hidden. Displayed.	Not active* Active

- Communication objects:
- [29 - Output 1 - Switching counter setpoint](#) (2 byte - 7.001 DPT_Value_2_Ucount)
 - [61 - Output 2 - Switching counter setpoint](#) (2 byte - 7.001 DPT_Value_2_Ucount)
 - [93 - Output 3 - Switching counter setpoint](#) (2 byte - 7.001 DPT_Value_2_Ucount)
 - [125 - Output 4 - Switching counter setpoint](#) (2 byte - 7.001 DPT_Value_2_Ucount)
 - [157 - Output 5 - Switching counter setpoint](#) (2 byte - 7.001 DPT_Value_2_Ucount)
 - [190 - Output 6 - Switching counter setpoint](#) (2 byte - 7.001 DPT_Value_2_Ucount)

* Default value

Parameter	Description	Value
Counter value emission	The Switching counter value communication object is sent: On each change. Periodically after a configurable time. On change and periodically after a configurable time.	On status change* Periodically On status change and periodically

Parameter	Description	Value
Value interval (switchings)	This parameter specifies the value interval (in number of switchings) for the sending frequency of the Switching counter value object.	1 ... 100* ... 65535

Note: If the value of the interval is 200 switchings, the **Switching counter value** will be sent each time, as soon as 200 switchings is counted.

Note: This parameter is only visible if the **Counter value emission** parameter has the following value: **On status change** or **On status change and periodically**.

Parameter	Description	Value
Periodical emission delay	This parameter determines the time between the individual transmissions of the Switching counter value object.	1 hours: 0 to 23 h 0 minutes: 0 to 59 min 0 seconds: 0 to 59 s

Note: This parameter is only visible if the **Counter value emission** parameter has the following value: **Periodically** or **On status change and periodically**.

Parameter	Description	Value
Object emission counter setpoint reached	The Switching counter value reached object is sent: On each change. Periodically after a configurable time. On change and periodically after a configurable time.	On status change* Periodically On status change and periodically

Parameter	Description	Value
Hours (h)	This parameter determines the time between the individual transmissions of the Counter setpoint reached object.	1 hours: 0 to 23 h
Minutes (min)		0 minutes: 0 to 59 min
Seconds (s)		0 seconds: 0 to 59 s

Note: This parameter is only visible if the Object **Emission counter setpoint reached** parameter has the following value: **Periodically** OR **On status change and periodically**.

* Default value

3.6.9.6 Emission current value

Device: 1.1.1 6-fold switch actuator 16A 230V current monitoring

Outputs 1-6: General

- O1-6: Manual mode
- O1-6: Status indications

Output 1: Function selection

- O1: Current detection

Output 2: Function selection

Output 3: Function selection

Output 4: Function selection

Output 5: Function selection

Output 6: Function selection

Information

Output current detection delay after switching Not active

Switching validation Not active

Current setpoint monitoring Not active

No current flow detection Not active

Switching counter Not active

Emission current value Active

Type of current value object 2 bytes in mA (DPT 7.012) ex. 2430 mA

Emission On status change

Value interval (mA) 100

Current det. in open contacts Not active

This function allows the current value to be sent over the KNX bus.

Parameter	Description	Value
Emission current value	This parameter is used to authorize the Current value object.	Not active* Active

- Communication objects:
- 30 - Output 1 - Current value** (2 byte- 7.012 DPT_UEICurrentmA)**
 - 62 - Output 2 - Current value** (2 byte - 7.012 DPT_UEICurrentmA)**
 - 94 - Output 3 - Current value** (2 byte - 7.012 DPT_UEICurrentmA)**
 - 126 - Output 4 - Current value** (2 byte - 7.012 DPT_UEICurrentmA)**
 - 158 - Output 5 - Current value** (2 byte - 7.012 DPT_UEICurrentmA)**
 - 191 - Output 6 - Current value** (2 byte - 7.012 DPT_UEICurrentmA)**

** The object type is dependent on the **Type of current value object** parameter.
(7.012 DPT_UEICurrentmA - 9.021 DPT_Value_Curr - 14.019 DPT_Value_Electric_Current).

Parameter	Description	Value
Type of current value object	The Current value communication object is sent in the following data format: 2 byte in mA, for example 2430 mA. 2 byte in mA, for example 2430.00 mA. 4 byte in A, for example 2.43 A.	2 bytes in mA (DPT 7.012) ex. 2430 mA* 2 bytes in mA (DPT 9.021) ex. 2430.00 mA 4 bytes in A (DPT 14.019) ex. 2.43 A

* Default value

Parameter	Description	Value
Emission	The Counter value communication object is sent: On each change. Periodically after a configurable time. On change and periodically after a configurable time.	On status change* Periodically On status change and periodically

Parameter	Description	Value
Value interval (mA)	This parameter specifies the value interval (in mA) for the sending frequency of the Current value object.	1 ... 100* ... 65535 (mA)

*Note: If the value interval is 200 mA, the **Current value** will be sent each time, as soon as 200 mA is counted.*

*Note: This parameter is only visible if the **Emission** parameter has the following value: **On status change** or **On status change and periodically**.*

Parameter	Description	Value
Hours (h)	This parameter determines the time between the individual transmissions of the Current value object.	1 hours: 0 to 23 h
Minutes (min)		0 minutes: 0 to 59 min
Seconds (s)		0 seconds: 0 to 59 s

*Note: This parameter is only visible if the **Emission** parameter has the following value: **Periodically** or **On status change and periodically**.*

* Default value

3.6.9.7 Current det. in open contacts

Device: 1.1.1 6-fold switch actuator 16A 230V current monitoring

Outputs 1-6: General

- O1-6: Manual mode
- O1-6: Status indications

Output 1: Function selection

- O1: Current detection

Output 2: Function selection

Output 3: Function selection

Output 4: Function selection

Output 5: Function selection

Output 6: Function selection

Information

Output current detection delay after switching Not active

Switching validation Not active

Current setpoint monitoring Not active

No current flow detection Not active

Switching counter Not active

Emission current value Not active

Current det. in open contacts Active

Acquisition time for notification after current in open contact (h) 0

Acquisition time for notification after current in open contact (min) 1

Acquisition time for notification after current in open contact (s) 0

Polarity of current detection in open contacts object 0 = No current detected, 1 = Current detected

Emission On status change

This function is used for notification of a current detection with open output contact.

Parameter	Description	Value
Current det. in open contacts	This parameter is used to authorize the Current det. in open contacts object.	Not active* Active

- Communication objects:
- [31 - Output 1 - Current det. in open contacts \(1 bit - 1.011 DPT_State\)](#)
 - [63 - Output 2 - Current det. in open contacts \(1 bit - 1.011 DPT_State\)](#)
 - [95 - Output 3 - Current det. in open contacts \(1 bit - 1.011 DPT_State\)](#)
 - [127 - Output 4 - Current det. in open contacts \(1 bit - 1.011 DPT_State\)](#)
 - [159 - Output 5 - Current det. in open contacts \(1 bit - 1.011 DPT_State\)](#)
 - [192 - Output 6 - Current det. in open contacts \(1 bit - 1.011 DPT_State\)](#)

Parameter	Description	Value
Acquisition time for notification after current in open contact	This parameter determines the time after which the Current det. in open contacts object is sent to the KNX bus.	0 hours: 0 to 23 h 1 minutes: 0 to 59 min 0 seconds: 0 to 59 s

Note: This parameter is only visible if the **Current det. in open contacts** parameter has the following value: **Active**.

* Default value

Parameter	Description	Value
Polarity of current detection in open contacts object	<p>The Current det. in open contacts communications object sends:</p> <p>0 if no current flow is detected. 1 if a current flow is detected in open contacts.</p> <p>0 if a current flow is detected in open contacts. 1 if no current flow is detected.</p>	<p>0 = No current detected, 1 = Current detected*</p> <p>0 = Current detected, 1 = No current detected</p>

Note: This parameter is only visible if the **Current det. in open contacts** parameter has the following value: **Active**.

Parameter	Description	Value
Emission	<p>The Current det. in open contacts communication object is sent:</p> <p>On each change. Periodically after a configurable time. On change and periodically after a configurable time.</p>	<p>On status change*</p> <p>Periodically On status change and periodically</p>

Parameter	Description	Value
Hours (h)	This parameter determines the time between the individual transmissions of the Current det. in open contacts object.	6 hours: 0 to 23 h
Minutes (min)		0 minutes: 0 to 59 min
Seconds (s)		0 seconds: 0 to 59 s

Note: This parameter is only visible if the **Emission** parameter has the following value: **Periodically** or **On status change and periodically**.

* Default value

4. Communication objects

4.1 Communication objects General

	Number	Name	Function of the object	Length	C	R	W	T
	192	Outputs 1-6	Deactivation of manual mode	1 bit	C	R	W	-
	193	Outputs 1-6	Status indication manual mode	1 bit	C	R	-	T
	194	Logic block 1	Authorization	1 bit	C	R	W	-
	195	Logic block 1	Input 1	1 bit	C	R	W	-
	196	Logic block 1	Input 2	1 bit	C	R	W	-
	197	Logic block 1	Input 3	1 bit	C	R	W	-
	198	Logic block 1	Input 4	1 bit	C	R	W	-
	199	Logic block 1	Logic result	1 bit	C	R	-	T
	200	Logic block 2	Authorization	1 bit	C	R	W	-
	201	Logic block 2	Input 1	1 bit	C	R	W	-
	202	Logic block 2	Input 2	1 bit	C	R	W	-
	203	Logic block 2	Input 3	1 bit	C	R	W	-
	204	Logic block 2	Input 4	1 bit	C	R	W	-
	205	Logic block 2	Logic result	1 bit	C	R	-	T
	206	Outputs 1-6	Restore ETS-params settings	1 bit	C	R	W	-
	207	Outputs 1-6	Device LED switch off	1 bit	C	R	W	-
	208	Outputs 1-6	Diagnosis	1 bit	C	R	-	T

4.1.1 Manual mode

No.	Name	Function of the object	Data type	Flags
192	Outputs 1-6	Deactivation of manual mode	1 bit - 1.001 DPT_Switch	C, R, W

This object is activated if the **Manual mode** parameter and the **Deactivation of manual mode** object are active.
 This object is used to control the manual mode via the KNX bus.
 Object value: Depends on the **Polarity** parameter.

0=Manual mode locked-up, 1=Manual mode authorized:

- If the object receives the value 1, manual mode is activated.
- If the object receives the value 0, manual mode is deactivated.

0=Manual mode authorized, 1=Manual mode locked-up:

- If the object receives the value 1, manual mode is deactivated.
- If the object receives the value 0, manual mode is activated.

For further information, see: [Manual mode](#).

No.	Name	Function of the object	Data type	Flags
193	Outputs 1-6	Status indication manual mode	1 bit - 1.011 DPT_State	C, R, T
<p>This object is activated if the Manual mode parameter and the Object status indication manual mode are active. This object is used to send the manual mode status of the device via the KNX bus. Object value: Depends on the Polarity parameter.</p> <p>0=Manual mode activated, 1=Manual mode deactivated:</p> <ul style="list-style-type: none"> - If manual mode is deactivated, a telegram is sent with logic value 1. - If manual mode is activated, a telegram is sent with logic value 0. <p>0=Manual mode deactivated, 1=Manual mode activated:</p> <ul style="list-style-type: none"> - If manual mode is activated, a telegram is sent with logic value 1. - If manual mode is deactivated, a telegram is sent with logic value 0. <p>This object is sent periodically and/or on status change. For further information, see: Manual mode.</p>				

4.1.2 Logic block

No.	Name	Function of the object	Data type	Flags
194	Logic block 1	Authorization	1 bit - 1.003 DPT_Enable	C, R, W
<p>This object is activated if the Logic block 1 parameter and the Lock-up logic block object are active. This object makes it possible to activate or deactivate the logic blocks of the device via the KNX bus. Object value: Depends on the Polarity parameter.</p> <p>0 = Locked-up, 1 = Authorized:</p> <ul style="list-style-type: none"> - If the object receives the value 0, logic block 1 is deactivated. - If the object receives the value 1, logic block 1 is activated. <p>0 = Authorized, 1 = Locked-up:</p> <ul style="list-style-type: none"> - If the object receives the value 0, logic block 1 is activated. - If the object receives the value 1, logic block 1 is deactivated. <p>The value of this object can be initialized at start-up of the device. For further information, see: Logic block.</p>				

No.	Name	Function of the object	Data type	Flags
195	Logic block 1	Input 1	1 bit - 1.002 DPT_Bool	C, R, W
196	Logic block 1	Input 2	1 bit - 1.002 DPT_Bool	C, R, W
197	Logic block 1	Input 3	1 bit - 1.002 DPT_Bool	C, R, W
198	Logic block 1	Input 4	1 bit - 1.002 DPT_Bool	C, R, W
<p>These objects are activated in accordance with the value of the Number of logic inputs parameter. There may be up to a maximum of 4 of these objects. These objects are used to produce the status of a logic input for processing of the logic operation. The value of these objects can be initialized at start-up of the device. For further information, see: Logic block.</p>				

No.	Name	Function of the object	Data type	Flags
199	Logic block 1	Logic result	1 bit - 1.002 DPT_Bool	C, R, T
<p>This object is activated when the Logic block 1 parameter is active.</p> <p>This object enables output of the results of the logic operation via the bus.</p> <p>The value of the object is the result of a logic AND or OR operation, according to the status of the logic inputs. There may be up to a maximum of 4 of these objects. This result can also be directly assigned to the status of the output contact.</p> <p>For further information, see: Logic block.</p>				

No.	Name	Function of the object	Data type	Flags
200	Logic block 2	Authorization	1 bit - 1.003 DPT_Enable	C, R, W
See object No. 194				

No.	Name	Function of the object	Data type	Flags
201	Logic block 2	Input 1	1 bit - 1.002 DPT_Bool	C, R, W
202	Logic block 2	Input 2	1 bit - 1.002 DPT_Bool	C, R, W
203	Logic block 2	Input 3	1 bit - 1.002 DPT_Bool	C, R, W
204	Logic block 2	Input 4	1 bit - 1.002 DPT_Bool	C, R, W
See object No. 195				

No.	Name	Function of the object	Data type	Flags
205	Logic block 2	Logic result	1 bit - 1.002 DPT_Bool	C, R, T
See object No. 199				

4.1.3 Behaviour of the device

No.	Name	Function of the object	Data type	Flags
206	Outputs 1-6	Restore ETS-params settings	1 bit - 1.015 DPT_Reset	C, R, W
<p>This object is activated if the Activ. of restore ETS-parameters object (scenes, timer, setpoints) parameter is active.</p> <p>This object enables the current parameter value to be replaced at any time with the ETS parameter value.</p> <p>If the object receives value 1, then the output status values for the scenes, the timer duration specifications and all the counter setpoints are reset to the values sent by the last download.</p> <p>For further information, see: Restore ETS-Parameters.</p>				

No.	Name	Function of the object	Data type	Flags
207	Outputs 1-6	Device LED switch off	1 bit - 1.001 DPT_Switch	C, R, W
<p>This object is activated if the Device LEDS lock-up object parameter is active.</p> <p>This function is used to reduce the overall power consumption of the device. It allows the LEDs on the front of the device to be switched off.</p> <p>Object value: Depends on the Polarity parameter.</p> <p>0 = Status indication, 1 = Always OFF:</p> <ul style="list-style-type: none"> - If the object receives value 0, the LED display is activated. - If the object receives value 1, the LED display is deactivated. <p>0 = Always OFF, 1 = Status indication:</p> <ul style="list-style-type: none"> - If the object receives value 0, the LED display is deactivated. - If the object receives value 1, the LED display is activated. <p>For further information, see: LED display.</p>				

4.1.4 Diagnosis

No.	Name	Function of the object	Data type	Flags														
208	Outputs 1-6	Diagnosis	6 byte - Specific	C, R, T														
<p>This object is activated when the Device diagnosis object parameter is active.</p> <p>The object enables reporting of current faults according to the device and the application used. It also allows sending of the position of the switch on the front of the device and the number of the output that is affected by the fault(s).</p> <table border="1" data-bbox="140 1003 1445 1099"> <thead> <tr> <th>Byte number</th> <th>6 (MSB)</th> <th>5</th> <th>4</th> <th>3</th> <th>2</th> <th>1(LSB)</th> </tr> </thead> <tbody> <tr> <td>Use</td> <td>Switch position</td> <td>Application type</td> <td>Output number</td> <td colspan="3">Error codes</td> </tr> </tbody> </table> <p>This object is sent periodically and/or on status change.</p> <p>For further information, see: Diagnosis.</p>					Byte number	6 (MSB)	5	4	3	2	1(LSB)	Use	Switch position	Application type	Output number	Error codes		
Byte number	6 (MSB)	5	4	3	2	1(LSB)												
Use	Switch position	Application type	Output number	Error codes														

4.2 Output communication objects

	Number	Name	Function of the object	Length	C	R	W	T
	0	Output 1	ON/OFF	1 bit	C	R	W	-
	1	Output 1	Timer/toggle switch changeover	1 bit	C	R	W	-
	2	Output 1	Time limited toggle switch object	1 bit	C	R	W	-
	3	Output 1	Status indication ON/OFF	1 bit	C	R	-	T
	4	Output 1	Timer	1 bit	C	R	W	-
	5	Output 1	Timer duration	3 byte	C	R	W	-
	6	Output 1	Scene	1 byte	C	R	W	-
	7	Output 1	Preset 1	1 bit	C	R	W	-
	8	Output 1	Preset 2	1 bit	C	R	W	-
	9	Output 1	Preset 1 authorization	1 bit	C	R	W	-
	10	Output 1	Preset 2 authorization	1 bit	C	R	W	-
	11	Output 1	Lock-up 1	1 bit	C	R	W	-
	12	Output 1	Lock-up 2	1 bit	C	R	W	-
	13	Output 1	Status indication lock-up	1 bit	C	R	-	T
	14	Output 1	Priority	2 bit	C	R	W	-
	15	Output 1	Status indication priority	1 bit	C	R	-	T
	16	Output 1	Hours counter value	2 byte	C	R	-	T
	17	Output 1	Reset hours counter value	1 bit	C	R	W	-
	18	Output 1	Hours counter setpoint reached	1 bit	C	R	-	T
	19	Output 1	Hours counter setpoint	2 byte	C	R	W	-
	20	Output 1	Current setpoint 1	2 byte	C	R	W	-
	21	Output 1	Current setpoint 2	2 byte	C	R	W	-
	22	Output 1	Current > Setpoint 1	1 bit	C	R	-	T
	23	Output 1	Setpoint 2 < Current < Setpoint 1	1 bit	C	R	-	T
	24	Output 1	Current < Setpoint 2	1 bit	C	R	-	T
	25	Output 1	No current flow detection	1 bit	C	R	-	T
	26	Output 1	Switching counter value	2 byte	C	R	-	T
	27	Output 1	Reset op. switching cntr value	1 bit	C	R	W	-
	28	Output 1	Switching cntr setpt. reached	1 bit	C	R	-	T
	29	Output 1	Switching counter setpoint	2 byte	C	R	W	-
	30	Output 1	Current value	2 byte	C	R	-	T
	31	Output 1	Current det. in open contacts	1 bit	C	R	-	T

	Number	Name	Function of the object	Length	C	R	W	T
	32	Output 2	ON/OFF	1 bit	C	R	W	-
	33	Output 2	Timer/toggle switch changeover	1 bit	C	R	W	-
	34	Output 2	Time limited toggle switch object	1 bit	C	R	W	-
	35	Output 2	Status indication ON/OFF	1 bit	C	R	-	T
	36	Output 2	Timer	1 bit	C	R	W	-
	37	Output 2	Timer duration	3 byte	C	R	W	-
	38	Output 2	Scene	1 byte	C	R	W	-
	39	Output 2	Preset 1	1 bit	C	R	W	-
	40	Output 2	Preset 2	1 bit	C	R	W	-
	41	Output 2	Preset 1 authorization	1 bit	C	R	W	-
	42	Output 2	Preset 2 authorization	1 bit	C	R	W	-
	43	Output 2	Lock-up 1	1 bit	C	R	W	-
	44	Output 2	Lock-up 2	1 bit	C	R	W	-
	45	Output 2	Status indication lock-up	1 bit	C	R	-	T
	46	Output 2	Priority	2 bit	C	R	W	-
	47	Output 2	Status indication priority	1 bit	C	R	-	T
	48	Output 2	Hours counter value	2 byte	C	R	-	T
	49	Output 2	Reset hours counter value	1 bit	C	R	W	-
	50	Output 2	Hours counter setpoint reached	1 bit	C	R	-	T
	51	Output 2	Hours counter setpoint	2 byte	C	R	W	-
	52	Output 2	Current setpoint 1	2 byte	C	R	W	-
	53	Output 2	Current setpoint 2	2 byte	C	R	W	-
	54	Output 2	Current > Setpoint 1	1 bit	C	R	-	T
	55	Output 2	Setpoint 2 < Current < Setpoint 1	1 bit	C	R	-	T
	56	Output 2	Current < Setpoint 2	1 bit	C	R	-	T
	57	Output 2	No current flow detection	1 bit	C	R	-	T
	58	Output 2	Switching counter value	2 byte	C	R	-	T
	59	Output 2	Reset op. switching cntr value	1 bit	C	R	W	-
	60	Output 2	Switching cntr setpt. reached	1 bit	C	R	-	T
	62	Output 2	Switching counter setpoint	2 byte	C	R	W	-
	62	Output 2	Current value	2 byte	C	R	-	T
	63	Output 2	Current det. in open contacts	1 bit	C	R	-	T

	Number	Name	Function of the object	Length	C	R	W	T
	64	Output 3	ON/OFF	1 bit	C	R	W	-
	65	Output 3	Timer/toggle switch changeover	1 bit	C	R	W	-
	66	Output 3	Time limited toggle switch object	1 bit	C	R	W	-
	67	Output 3	Status indication ON/OFF	1 bit	C	R	-	T
	68	Output 3	Timer	1 bit	C	R	W	-
	69	Output 3	Timer duration	3 byte	C	R	W	-
	70	Output 3	Scene	1 byte	C	R	W	-
	71	Output 3	Preset 1	1 bit	C	R	W	-
	72	Output 3	Preset 2	1 bit	C	R	W	-
	73	Output 3	Preset 1 authorization	1 bit	C	R	W	-
	74	Output 3	Preset 2 authorization	1 bit	C	R	W	-
	75	Output 3	Lock-up 1	1 bit	C	R	W	-
	76	Output 3	Lock-up 2	1 bit	C	R	W	-
	77	Output 3	Status indication lock-up	1 bit	C	R	-	T
	78	Output 3	Priority	2 bit	C	R	W	-
	79	Output 3	Status indication priority	1 bit	C	R	-	T
	80	Output 3	Hours counter value	2 byte	C	R	-	T
	81	Output 3	Reset hours counter value	1 bit	C	R	W	-
	82	Output 3	Hours counter setpoint reached	1 bit	C	R	-	T
	83	Output 3	Hours counter setpoint	2 byte	C	R	W	-
	84	Output 3	Current setpoint 1	2 byte	C	R	W	-
	85	Output 3	Current setpoint 2	2 byte	C	R	W	-
	86	Output 3	Current > Setpoint 1	1 bit	C	R	-	T
	87	Output 3	Setpoint 2 < Current < Setpoint 1	1 bit	C	R	-	T
	88	Output 3	Current < Setpoint 2	1 bit	C	R	-	T
	89	Output 3	No current flow detection	1 bit	C	R	-	T
	90	Output 3	Switching counter value	2 byte	C	R	-	T
	91	Output 3	Reset op. switching cntr value	1 bit	C	R	W	-
	92	Output 3	Switching cntr setpt. reached	1 bit	C	R	-	T
	93	Output 3	Switching counter setpoint	2 byte	C	R	W	-
	94	Output 3	Current value	2 byte	C	R	-	T
	95	Output 3	Current det. in open contacts	1 bit	C	R	-	T

	Number	Name	Function of the object	Length	C	R	W	T
	96	Output 4	ON/OFF	1 bit	C	R	W	-
	97	Output 4	Timer/toggle switch changeover	1 bit	C	R	W	-
	98	Output 4	Time limited toggle switch object	1 bit	C	R	W	-
	99	Output 4	Status indication ON/OFF	1 bit	C	R	-	T
	100	Output 4	Timer	1 bit	C	R	W	-
	101	Output 4	Timer duration	3 byte	C	R	W	-
	102	Output 4	Scene	1 byte	C	R	W	-
	103	Output 4	Preset 1	1 bit	C	R	W	-
	104	Output 4	Preset 2	1 bit	C	R	W	-
	105	Output 4	Preset 1 authorization	1 bit	C	R	W	-
	106	Output 4	Preset 2 authorization	1 bit	C	R	W	-
	107	Output 4	Lock-up 1	1 bit	C	R	W	-
	108	Output 4	Lock-up 2	1 bit	C	R	W	-
	109	Output 4	Status indication lock-up	1 bit	C	R	-	T
	110	Output 4	Priority	2 bit	C	R	W	-
	111	Output 4	Status indication priority	1 bit	C	R	-	T
	112	Output 4	Hours counter value	2 byte	C	R	-	T
	113	Output 4	Reset hours counter value	1 bit	C	R	W	-
	114	Output 4	Hours counter setpoint reached	1 bit	C	R	-	T
	115	Output 4	Hours counter setpoint	2 byte	C	R	W	-
	116	Output 4	Current setpoint 1	2 byte	C	R	W	-
	117	Output 4	Current setpoint 2	2 byte	C	R	W	-
	118	Output 4	Current > Setpoint 1	1 bit	C	R	-	T
	119	Output 4	Setpoint 2 < Current < Setpoint 1	1 bit	C	R	-	T
	120	Output 4	Current < Setpoint 2	1 bit	C	R	-	T
	121	Output 4	No current flow detection	1 bit	C	R	-	T
	122	Output 4	Switching counter value	2 byte	C	R	-	T
	123	Output 4	Reset op. switching cntr value	1 bit	C	R	W	-
	124	Output 4	Switching cntr setpt. reached	1 bit	C	R	-	T
	125	Output 4	Switching counter setpoint	2 byte	C	R	W	-
	126	Output 4	Current value	2 byte	C	R	-	T
	127	Output 4	Current det. in open contacts	1 bit	C	R	-	T

	Number	Name	Function of the object	Length	C	R	W	T
	128	Output 5	ON/OFF	1 bit	C	R	W	-
	129	Output 5	Timer/toggle switch changeover	1 bit	C	R	W	-
	130	Output 5	Time limited toggle switch object	1 bit	C	R	W	-
	131	Output 5	Status indication ON/OFF	1 bit	C	R	-	T
	132	Output 5	Timer	1 bit	C	R	W	-
	133	Output 5	Timer duration	3 byte	C	R	W	-
	134	Output 5	Scene	1 byte	C	R	W	-
	135	Output 5	Preset 1	1 bit	C	R	W	-
	136	Output 5	Preset 2	1 bit	C	R	W	-
	137	Output 5	Preset 1 authorization	1 bit	C	R	W	-
	138	Output 5	Preset 2 authorization	1 bit	C	R	W	-
	139	Output 5	Lock-up 1	1 bit	C	R	W	-
	140	Output 5	Lock-up 2	1 bit	C	R	W	-
	141	Output 5	Status indication lock-up	1 bit	C	R	-	T
	142	Output 5	Priority	2 bit	C	R	W	-
	143	Output 5	Status indication priority	1 bit	C	R	-	T
	144	Output 5	Hours counter value	2 byte	C	R	-	T
	145	Output 5	Reset hours counter value	1 bit	C	R	W	-
	146	Output 5	Hours counter setpoint reached	1 bit	C	R	-	T
	147	Output 5	Hours counter setpoint	2 byte	C	R	W	-
	148	Output 5	Current setpoint 1	2 byte	C	R	W	-
	149	Output 5	Current setpoint 2	2 byte	C	R	W	-
	150	Output 5	Current > Setpoint 1	1 bit	C	R	-	T
	151	Output 5	Setpoint 2 < Current < Setpoint 1	1 bit	C	R	-	T
	152	Output 5	Current < Setpoint 2	1 bit	C	R	-	T
	153	Output 5	No current flow detection	1 bit	C	R	-	T
	154	Output 5	Switching counter value	2 byte	C	R	-	T
	155	Output 5	Reset op. switching cntr value	1 bit	C	R	W	-
	156	Output 5	Switching cntr setpt. reached	1 bit	C	R	-	T
	157	Output 5	Switching counter setpoint	2 byte	C	R	W	-
	158	Output 5	Current value	2 byte	C	R	-	T
	159	Output 5	Current det. in open contacts	1 bit	C	R	-	T

	Number	Name	Function of the object	Length	C	R	W	T
	160	Output 6	ON/OFF	1 bit	C	R	W	-
	161	Output 6	Timer/toggle switch changeover	1 bit	C	R	W	-
	162	Output 6	Time limited toggle switch object	1 bit	C	R	W	-
	163	Output 6	Status indication ON/OFF	1 bit	C	R	-	T
	164	Output 6	Timer	1 bit	C	R	W	-
	165	Output 6	Timer duration	3 byte	C	R	W	-
	166	Output 6	Scene	1 byte	C	R	W	-
	167	Output 6	Preset 1	1 bit	C	R	W	-
	168	Output 6	Preset 2	1 bit	C	R	W	-
	169	Output 6	Preset 1 authorization	1 bit	C	R	W	-
	170	Output 6	Preset 2 authorization	1 bit	C	R	W	-
	171	Output 6	Lock-up 1	1 bit	C	R	W	-
	172	Output 6	Lock-up 2	1 bit	C	R	W	-
	173	Output 6	Status indication lock-up	1 bit	C	R	-	T
	174	Output 6	Priority	2 bit	C	R	W	-
	175	Output 6	Status indication priority	1 bit	C	R	-	T
	176	Output 6	Hours counter value	2 byte	C	R	-	T
	177	Output 6	Reset hours counter value	1 bit	C	R	W	-
	178	Output 6	Hours counter setpoint reached	1 bit	C	R	-	T
	179	Output 6	Hours counter setpoint	2 byte	C	R	W	-
	180	Output 6	Current setpoint 1	2 byte	C	R	W	-
	181	Output 6	Current setpoint 2	2 byte	C	R	W	-
	182	Output 6	Current > Setpoint 1	1 bit	C	R	-	T
	183	Output 6	Setpoint 2 < Current < Setpoint 1	1 bit	C	R	-	T
	184	Output 6	Current < Setpoint 2	1 bit	C	R	-	T
	185	Output 6	No current flow detection	1 bit	C	R	-	T
	186	Output 6	Switching counter value	2 byte	C	R	-	T
	187	Output 6	Reset op. switching cntr value	1 bit	C	R	W	-
	188	Output 6	Switching cntr setpt. reached	1 bit	C	R	-	T
	189	Output 6	Switching counter setpoint	2 byte	C	R	W	-
	190	Output 6	Current value	2 byte	C	R	-	T
	191	Output 6	Current det. in open contacts	1 bit	C	R	-	T

4.2.1 ON/OFF

No.	Name	Function of the object	Data type	Flags
0, 32, 64, 96, 128, 160	Output x	ON/OFF	1 bit - 1.001 DPT_Switch	C, R, W

These objects are always activated. They enable switching of the output contact in accordance with the value that is sent via the KNX bus.

Object value: Object value: depends on the **Output contact** parameter.

Normally open:

- On input of an OFF command, the output relay contact opens.
- On input of an ON command, the output relay contact closes.

Normally closed:

- On input of an OFF command, the output relay contact closes.
- On input of an ON command, the output relay contact opens.

For further information, see: [Definition](#).

4.2.2 ON/OFF timings function

No.	Name	Function of the object	Data type	Flags
1, 33, 65, 97, 129, 161	Output x	Timer/toggle switch changeover	1 bit - 1.001 DPT_Switch	C, R, W

This object is activated if the **Timer/toggle switch changeover for ON/OFF** object parameter is active.

This object is used to switch between a toggle switch and timer switch operation on the same pushbutton.

- If the **Timer/toggle switch changeover** object receives the value 1, the Toggle-switch mode function is activated. The ON/OFF switching of the output is performed as usual via the **ON/OFF** object.
- If the **Timer/toggle switch changeover** object receives the value 0, the Timer mode function is activated.
 - If the **ON/OFF** object receives the value 1, the output is switched ON. After expiry of a configurable time, the output is automatically switched OFF.
 - If the **ON/OFF** object receives the value 0, the output is switched OFF.

*Example: Switching function daytime and Time-limited OFF function at night.
During the day, the button is used as a switch. In the evenings, the button is used as a time-limited OFF switch, so that the light will turn off automatically.*

For further information, see: [ON/OFF timings function](#).

No.	Name	Function of the object	Data type	Flags
2, 34, 66, 98, 130, 162	Output x	Time limited toggle switch object	1 bit - 1.001 DPT_Switch	C, R, W

This object is activated when the **Additional time limited toggle switch function** parameter is active.

This object combines a timer function with a tripping Delay function.

- If the object receives the value 1, the output switches to ON for a configurable time period. After that period expires, the output switches to OFF.
- If the object receives the value 0, the output switches to OFF.

Note: The time-limited OFF function is generally used for lighting in cellars, attics and sheds.

For further information, see: [ON/OFF timings function](#).

4.2.3 Status indication

No.	Name	Function of the object	Data type	Flags
3, 35, 67, 99, 131, 163	Output x	Status indication ON/OFF	1 bit - 1.001 DPT_Switch	C, R, T

This object is activated when the **Status indication ON/OFF** parameter is active.
 This object allows the status of the output contact to be sent from the device over the KNX bus.
 Object value: Depends on the **Polarity** parameter.

0 = ON, 1 = OFF

- If the output relay is open, a telegram with logic value 1 is sent on the KNX bus.
- If the output relay is closed, a telegram with logic value 0 is sent on the KNX bus.

0 = OFF, 1 = ON

- If the output relay is open, a telegram with logic value 0 is sent on the KNX bus.
- If the output relay is closed, a telegram with logic value 1 is sent on the KNX bus.

This object is sent periodically and/or on status change.

For further information, see: [Status indication](#).

4.2.4 Timer

No.	Name	Function of the object	Data type	Flags
4, 36, 68, 100, 132, 164	Output x	Timer	1 bit - 1.001 DPT_Switch	C, R, W

This object is activated when the **Timer** parameter is active.
 This object is used to activate the Timer function of the device via the KNX bus.
 Object value:

- If a rising edge (0 to 1) arrives at this object, the output switches for a configurable period.
- If a falling edge (1 to 0) arrives at this object, the output remains in its current state.

Note: Depending on the configuration, the timer switching can be interrupted on the timer by a long press of the control button.
Note: Depending on the configuration, the timer duration may be reset by input of a start command during timer operation.

For further information, see: [Timer](#).

No.	Name	Function of the object	Data type	Flags
5, 37, 69, 101, 133, 165	Output x	Timer duration	3 byte - 10.001 DPT_TimeOfDay	C, R, W

This object is activated if the **Timer duration modifiable through object** object parameter is active.
 This object can be used to configure the timer duration. The timer duration can thus be configured in accordance with a time of day.

Byte 3 (MSB)					Byte 2						Byte 1 (LSB)												
			Hours				Minutes						Seconds										
0	0	0	H	H	H	H	H	0	0	M	M	M	M	M	M	0	0	S	S	S	S	S	S

Fields	Code	Value	Units
Hours	Binary	0 to 23 (5 bit)	Hours
Minutes	Binary	0 to 59 (6 bit)	Minutes
Seconds	Binary	0 to 59 (6 bit)	Seconds

For further information, see: [Timer](#).

4.2.5 Scene

No.	Name	Function of the object	Data type	Flags
6, 38, 70, 102, 134, 166	Output x	Scene	1 byte - 17.001 DPT_SceneNumber	C, R, W

This object is activated when the **Scene** parameter is active.
 This object is used to recall or save a scene.
 Details on the format of the object are given below.

7	6	5	4	3	2	1	0
Learning	Not used	Scene number					

Bit 7: 0: The scene is called / 1: The scene is saved.
 Bit 6: Not used.
 Bit 5 to Bit 0: Scene numbers from 0 (Scene 1) to 63 (Scene 64).

For further information, see: [Scene](#).

4.2.6 Preset

No.	Name	Function of the object	Data type	Flags
7, 39, 71, 103, 135, 167	Output x	Preset 1	1 bit - 1.022 DPT_Scene_AB	C, R, W
<p>This object is activated if the Preset has value Active with preset 1-level object or Active with preset 2-level objects. With this object, several outputs can be set to a configurable predefined status. Object value:</p> <ul style="list-style-type: none"> - If the object receives value 0, the values of the parameters for Preset 1 = 0 are used. - If the object receives value 1, the values of the parameters for Preset 1 = 1 are used. <p>For further information, see: Preset.</p>				

No.	Name	Function of the object	Data type	Flags
8, 40, 72, 104, 136, 168	Output x	Preset 2	1 bit - 1.022 DPT_Scene_AB	C, R, W
<p>This object is activated if the Preset parameter has value Active with preset 2-level objects.</p> <p>See object No. 7</p>				

No.	Name	Function of the object	Data type	Flags
9, 41, 73, 105, 137, 169	Output x	Preset 1 authorization	1 bit - 1.003 DPT_Enable	C, R, W
<p>This object is activated if the Preset authorization objects parameter is active. This object allows the authorization or lock-up of the Preset 1 function via a KNX telegram. Object value: This is dependent on the Polarity of autorisation object Preset 1 parameter. 0 = Locked-up, 1 = Authorized:</p> <ul style="list-style-type: none"> - If the object receives the value 0, Preset 1 is deactivated. - If the object receives the value 1, Preset 1 is activated. <p>0 = Authorized, 1 = Locked-up:</p> <ul style="list-style-type: none"> - If the object receives the value 0, Preset 1 is activated. - If the object receives the value 1, Preset 1 is deactivated. <p>For further information, see: Preset.</p>				

No.	Name	Function of the object	Data type	Flags
10, 42, 74, 106, 138, 170	Output x	Preset 2 authorization	1 bit - 1.003 DPT_Enable	C, R, W
<p>See object No. 9</p>				

4.2.7 Lock-up

No.	Name	Function of the object	Data type	Flags
11, 43, 75, 107, 139, 171	Output x	Lock-up 1	1 bit - 1.003 DPT_Enable	C, R, W
<p>This object is activated if the Lock-up has value Active with 1 lock-up object or Active with 2 lock-up objects. This object is used to control the activation of the lock-up via the KNX bus. Object value: This is dependent on the Polarity of lock-up object 1 parameter. 0 = Lock-up activated, 1 = Lock-up deactivated:</p> <ul style="list-style-type: none"> - If the object receives value 0, the Lock-up is activated. - If the object receives value 1, the Lock-up is deactivated. <p>0 = Lock-up deactivated, 1 = Lock-up activated:</p> <ul style="list-style-type: none"> - If the object receives value 0, the Lock-up is deactivated. - If the object receives value 1, the Lock-up is activated. <p>For further information, see: Lock-up.</p>				

No.	Name	Function of the object	Data type	Flags
12, 44, 76, 108, 140, 172	Output x	Lock-up 2	1 bit - 1.003 DPT_Enable	C, R, W
<p>This object is activated if the Lock-up parameter has value Active with 2 lock-up objects.</p> <p>See object No. 11.</p>				

No.	Name	Function of the object	Data type	Flags
13, 45, 77, 109, 141, 173	Output x	Status indication lock-up	1 bit - 1.011 DPT_Enable	C, R, T
<p>This object is activated when the Activation of lock-up status object parameter is active. This object allows the status of the lock-up to be sent from the device over the KNX bus. Object value: Depends on the Polarity parameter. 0 = Lock-up deactivated, 1 = Lock-up activated:</p> <ul style="list-style-type: none"> - If the lock-up is deactivated, a telegram with logic value 0 is sent on the KNX bus. - If the lock-up is activated, a telegram with logic value 1 is sent on the KNX bus. <p>0 = Lock-up activated, 1 = Lock-up deactivated:</p> <ul style="list-style-type: none"> - If the lock-up is activated, a telegram with logic value 0 is sent on the KNX bus. - If the lock-up is deactivated, a telegram with logic value 1 is sent on the KNX bus. <p>This object is sent periodically and/or on status change. For further information, see: Lock-up.</p>				

4.2.8 Priority

No.	Name	Function of the object	Data type	Flags
14, 46, 78, 110, 142, 174	Output x	Priority	2 bit - 2.002 DPT_Bool_Control	C, R, W

This object is activated if the **Priority** parameter is active.
 The status of the output contact is determined directly by this object.
 Details on the format of the object are given below.

Telegram received by the priority operation object		Status of the outputs
Bit 1	Bit 2	
0	0	End of the priority
0	1	End of the priority
1	0	Priority OFF
1	1	Priority ON

The first bit of this object (Bit 0) determines the status of the output contact, which should be priority controlled. The second bit activates or deactivates the Priority.

For further information, see: [Priority](#).

No.	Name	Function of the object	Data type	Flags
15, 47, 79, 111, 143, 175	Output x	Status indication priority	1 bit - 1.011 DPT_State	C, R, T

This object is activated if the **Activation of priority status object** parameter is active.
 This object allows the status of the Priority to be sent from the device on the KNX bus.
 Object value: Depends on the **Polarity** parameter.

0 = Not forced, 1 = Forced:

- If Priority is deactivated, a telegram is sent with logic value 0.
- If Priority is activated, a telegram is sent with logic value 1.

0 = Forced, 1 = Not forced:

- If Priority is activated, a telegram is sent with logic value 0.
- If Priority is deactivated, a telegram is sent with logic value 1.

This object is sent periodically and/or on status change.

For further information, see: [Priority](#).

4.2.9 Hours counter

No.	Name	Function of the object	Data type	Flags
16, 48, 80, 112, 144, 176	Output x	Hours counter value	2 byte - 7.001 DPT_16_bit_Counter	C, R, T

This object is activated when the **Hours counter** parameter is active.
 This object allows the value of the operating hours to be sent from the device on the KNX bus.
 The count value is saved during a power cut on the KNX bus. It is submitted after return of power to the bus or after an ETS download.
 Object value: 0 to 65535 hours.

This object is sent periodically and/or on status change.
 For further information, see: [Hours counter](#).

No.	Name	Function of the object	Data type	Flags
17, 49, 81, 113, 145, 177	Output x	Reset hours counter value	1 bit - 1.015 DPT_Reset	C, R, W

This object is activated when the **Hours counter** parameter is active.
 This object enables the hours counter value to be reset.
 Object value:

- If the object receives the value 0, the counter is not reset.
- If the object receives the value 1, the counter is reset.

For further information, see: [Hours counter](#).

No.	Name	Function of the object	Data type	Flags
18, 50, 82, 114, 146, 178	Output x	Hours counter setpoint reached	1 bit - 1.002 DPT_Bool	C, R, T

This object is activated when the **Hours counter** parameter is active.
 This object reports that the hours counter has reached its setpoint.

- Incrementing counter: Counter = Counter value setpoint.
- Countdown counter: Counter = 0.

Object value: If the setpoint is reached, a telegram with logic value 1 is sent on the KNX bus.
 The count value is saved during a power cut on the KNX bus. It is submitted after return of power to the bus or after an ETS download.

This object is sent periodically and/or on status change.
 For further information, see: [Hours counter](#).

No.	Name	Function of the object	Data type	Flags
19, 51, 83, 115, 147, 179	Output x	Counter value setpoint	2 byte - 7.001 DPT_16_bit_Counter	C, R, W

This object is activated if the **Counter setpoint value modifiable through object** object parameter is active. This object is used to initialize the counter setpoint of the hours counter via the KNX bus.
 Object value: 0 to 65535 hours.

This object is sent periodically and/or on status change.
 For further information, see: [Hours counter](#).

4.2.10 Current detection

No.	Name	Function of the object	Data type	Flags
20, 52, 84, 116, 148, 180	Output x	Current setpoint 1	2 byte - 7.012 DPT_UEICurrentmA	C, R, W
<p>This object is activated if the Current setpoint monitoring parameter has the value 1 setpoint current monitoring or 2 setpoints current monitoring.</p> <p>This object is used to set Current setpoint 1 via the KNX bus: Object value: 0 to 65535 mA.</p> <p>For further information, see: Current detection.</p>				

No.	Name	Function of the object	Data type	Flags
21, 53, 85, 117, 149, 181	Output x	Current setpoint 2	2 byte - 7.012 DPT_UEICurrentmA	C, R, W
<p>This object is activated if the Current setpoint monitoring parameter has the value 2 setpoints current monitoring.</p> <p>See object No. 20.</p>				

No.	Name	Function of the object	Data type	Flags
22, 54, 86, 118, 150, 182	Output x	Current > Setpoint 1	1 bit - 1.011 DPT_State	C, R, T
<p>This object is activated if the Current setpoint monitoring parameter has the value 1 setpoint current monitoring or 2 setpoints current monitoring.</p> <p>This object is used for notification of the exceeding of output current setpoint 1. Object value: This is dependent on the Polarity of current over setpoint 1 object parameter.</p> <p>0 = Current < Setpoint 1, 1 = Current > Setpoint 1:</p> <ul style="list-style-type: none"> - If the current value is less than current setpoint 1, a telegram with logic value 0 is sent to the object. - If the current value is greater than current setpoint 1, a telegram with logic value 1 is sent to the object. <p>0 = Current > Setpoint 1, 1 = Current < Setpoint 1:</p> <ul style="list-style-type: none"> - If the current value is greater than current setpoint 1, a telegram with logic value 0 is sent to the object. - If the current value is less than current setpoint 1, a telegram with logic value 1 is sent to the object. <p>This object is sent periodically and/or on status change. For further information, see: Current detection.</p>				

No.	Name	Function of the object	Data type	Flags
23, 55, 87, 119, 151, 183	Output x	Setpoint 2<Current<Setpoint 1	1 bit - 1.011 DPT_State	C, R, T

This object is activated if the **Current setpoint monitoring** parameter has the value **2 setpoints current monitoring**.
This object is used for notification of an output current between setpoints 1 and 2.

Object value: This is dependent on the **Polarity of current between setpoint 1 and 2 object** parameter.

0= Current betw.SP1&2, 1= Current not betw.SP1&2:

- If the current value is not between setpoint 1 and setpoint 2, a telegram with logic value 1 is sent to the object.
- If the current value is between setpoint 1 and setpoint 2, a telegram with logic value 0 is sent to the object.

0= Current not betw.SP1&2, 1= Current betw.SP1&2:

- If the current value is between setpoint 1 and setpoint 2, a telegram with logic value 1 is sent to the object.
- If the current value is not between setpoint 1 and setpoint 2, a telegram with logic value 0 is sent to the object.

This object is sent periodically and/or on status change.

For further information, see: [Current detection](#).

No.	Name	Function of the object	Data type	Flags
24, 56, 88, 120, 152, 184	Output x	Current < Setpoint 2	1 bit - 1.011 DPT_State	C, R, T

This object is activated if the **Current setpoint monitoring** parameter has the value **2 setpoints current monitoring**.

This object is used for notification of the exceeding of output current setpoint 2.

Object value: This is dependent on the **Polarity of current under setpoint 2 object** parameter.

0 = Current > Setpoint 2, 1 = Current < Setpoint 2:

- If the current value is greater than current setpoint 2, a telegram with logic value 0 is sent to the object.
- If the current value is less than current setpoint 2, a telegram with logic value 1 is sent to the object.

0 = Current < Setpoint 2, 1 = Current > Setpoint 2:

- If the current value is less than current setpoint 2, a telegram with logic value 1 is sent to the object.
- If the current value is greater than current setpoint 2, a telegram with logic value 0 is sent to the object.

This object is sent periodically and/or on status change.

For further information, see: [Current detection](#).

No.	Name	Function of the object	Data type	Flags
25, 57, 89, 121, 153, 185	Output x	No current flow detection	1 bit - 1.011 DPT_State	C, R, T

This object is activated if the **No current flow detection** parameter has the value **2 setpoints current monitoring**.
 This object is used for notification of a zero current consumption for a given period on closed output contact.
 Object value: This is dependent on the **Polarity of no current flow detection object** parameter.

0 = No current stop detect., 1 = Current stop det.:

- If a current consumption is detected on closed contacts, a telegram with logic value 0 is sent by the object.
- If, on closed output contacts, during a period specified by the **Acquisition time for notification no current flow detection** parameter, no current flow is detected, a telegram with logic value 1 is sent by the object.

0 = No current detected, 1 = Current detected:

- If, on closed output contacts, during a period specified by the **Acquisition time for notification no current flow detection** parameter, no current flow is detected, a telegram with logic value 0 is sent by the object.
- If a current consumption is detected on closed contacts, a telegram with logic value 1 is sent by the object.

This object is sent periodically and/or on status change.

For further information, see: [Current detection](#).

No.	Name	Function of the object	Data type	Flags
26, 58, 90, 122, 154, 186	Output x	Switching counter value	2 byte - 7.001 DPT_Value_2_Ucount	C, R, T

This object is activated if the **Switching counter** parameter is active.
 This object is used for emission of the number of switches from ON to OFF or from OFF to ON for any output to the KNX bus.
 The count value is saved during a power cut on the KNX bus. It is submitted after return of power to the bus or after an ETS download.
 Object value: 0 to 65535 switches.

This object is sent periodically and/or on status change.

For further information, see: [Current detection](#).

No.	Name	Function of the object	Data type	Flags
27, 59, 91, 123, 155, 187	Output x	Reset op. switching cntr value	1 bit - 1.015 DPT_Reset	C, R, W

This object is activated if the **Switching counter** parameter is active.
 This object is used to reset the value of the count of switching from ON to OFF or from OFF to ON.

Object value:

- If the object receives the value 0, the counter is not reset.
- If the object receives the value 1, the counter is reset.

For further information, see: [Current detection](#).

No.	Name	Function of the object	Data type	Flags
28, 60, 92, 124, 156, 188	Output x	Switching cntr setpt. reached	1 bit - 1.011 DPT_State	C, R, T

This object is activated if the **Switching counter** parameter is active.
This object sends notification that the switching counter has reached its setpoint.

- Incrementing counter: Counter = Counter value setpoint.
- Countdown counter: Counter = 0.

Object value: If the setpoint is reached, a telegram with logic value 1 is sent on the KNX bus.
The count value is saved during a power cut on the KNX bus. It is submitted after return of power to the bus or after an ETS download.

For further information, see: [Current detection](#).

No.	Name	Function of the object	Data type	Flags
29, 61, 93, 125, 157, 189	Output x	Switching counter setpoint	2 byte - 7.001 DPT_Value_2_Ucount	C, R, W

This object is activated if the **Switching counter** setpoint value modifiable through object parameter is active.
This object is used to initialize the switching counter setpoint via the KNX bus.
Object value: 0 to 65535 hours.

This object is sent periodically and/or on status change.
For further information, see: [Current detection](#).

No.	Name	Function of the object	Data type	Flags
30, 62, 94, 126, 158, 190	Output x	Current value	2 byte - 7.012 DPT_UEICurrentmA	C, R, T

This object is activated if the **Emission current value** parameter is active.
This object allows the status of the current value to be sent over the KNX bus.
Object value: This is dependent on the **Type of current value object** parameter.

- 2 byte in mA (7.012 DPT_UEICurrentmA): 0 to 65535 mA
- 2 byte in mA (9.021 DPT_Value_Curr): +/- 670760 mA
- 4 byte in A (14.019 DPT_Value_Electric_Current): 0 to 4294967295 A

The current setpoint is limited by the output contact.
(Contact open: No current 0mA) - Contact closed: Maximum 16A.

This object is sent periodically and/or on status change.
For further information, see: [Current detection](#).

No.	Name	Function of the object	Data type	Flags
31, 63, 95, 127, 159, 191	Output x	Current det. in open contacts	1 bit - 1.011 DPT_State	C, R, T

This object is activated if the **Current det. in open contacts** parameter is active.

This object is used for notification of a current detection with open output contact.

Object value: This is dependent on the **Polarity of current detection in open contacts object** parameter.

0 = No current detected, 1 = Current detected:

- If no current flow is detected on open output contacts, a telegram with logic value 0 is sent by the object.
- If current flow is detected on open output contacts, a telegram with logic value 1 is sent by the object.

0 = Current detected, 1 = No current detected:

- If current flow is detected on open output contacts, a telegram with logic value 0 is sent by the object.
- If no current flow is detected on open output contacts, a telegram with logic value 1 is sent by the object.







This object is sent periodically and/or on status change.

For further information, see: [Current detection](#).

5. Appendix

5.1 Specifications

Supply voltage	30 V DC
Power dissipation	6 W
Typical consumption on the KNX bus	6,2 mA
Standby consumption on the KNX bus	5,1 mA
Measurement range	0.05 A → 16 A
Measurement Accuracy < 2% ± 10mA on the whole range	
Measurement steps	50 mA
Operating temperature	-5 °C → + 45 °C
Storage temperature	- 20 °C → + 70 °C
Electrical connection	 0,75 mm ² → 2,5 mm ²
Breaking capacity	μ230V~ 16A AC1
Maximum permissible current per device (sum C1...C6)	max. 68A
Maximum switching rate at full load	6 switching cycles/minute
Installation mode	DIN rail
Dimensions	6 x 17,5 mm
Operating altitude	< 2000 m
Pollution level	2
Surge voltage	4 kV
Protection rating	IP 20 (housing) / IP30 (housing under faceplate)
IK	04
Overvoltage category	III
Norme	EN50491-3 ; EN60669-2-1

Load type			
	230 V~	Incandescent lamps	2300 W
	230 V~	Halogen lamps	2300 W
	12V ~ 24V DC	Conventional transformer	1600 W
	12V DC 24V DC	Electronic transformer	1380 W
	230 V~	Fluorescent tubes non compensated	800 W
		Fluorescent tubes for electronic ballast (mono or duo)	25 x 18 W
		Parallel compensated fluorescent tubes	1000 W 130 μF
	230 V~	Compact fluorescent	25 x 18 W
LED	230 V~	LED	200 W

5.2 Table of logical operations

Input 4	Input 3	Input 2	Input 1	OR	AND
-	-	0	0	0	0
-	-	0	1	1	0
-	-	1	0	1	0
-	-	1	1	1	1
-	0	0	0	0	0
-	0	0	1	1	0
-	0	1	0	1	0
-	0	1	1	1	0
-	1	0	0	1	0
-	1	0	1	1	0
-	1	1	0	1	0
-	1	1	1	1	1
0	0	0	0	0	0
0	0	0	1	1	0
0	0	1	0	1	0
0	0	1	1	1	0
0	1	0	0	1	0
0	1	0	1	1	0
0	1	1	0	1	0
0	1	1	1	1	0
1	0	0	0	1	0
1	0	0	1	1	0
1	0	1	0	1	0
1	0	1	1	1	0
1	1	0	0	1	0
1	1	0	1	1	0
1	1	1	0	1	0
1	1	1	1	1	1

5.3 Characteristics

Product	TYA606E
Max. number of group addresses	254
Max. number of allocations	255
Objects	209

