

	<h2>application software</h2>	
<ul style="list-style-type: none"> ▲ Manufacturers ▲ Hager Electro ▲ Outputs <ul style="list-style-type: none"> 1-output module 	<p>1 switch actuator</p> <p><i>Electrical/Mechanical characteristics: see product user manual</i></p>	

	Product reference	Product designation	Application software ref	TP device Radio device
	TYB601B	1 flush mounted output 10A twisted pair	STYB601B 1.x Version	

Content

1. General	3
1.1 About this guide	3
1.2 About the program	3
1.2.1 ETS compatibility	3
1.2.2 Application descriptions	3
2. General Description	4
2.1 Installation of the device	4
2.1.1 Overview presentation	4
2.1.2 Description of the device	5
2.1.3 Physical addressing	5
2.2 Function modules of the application	6
2.2.1 Primary functions	7
2.2.2 Additional functions	8
3. Parameters	9
3.1 Definition of the general parameters	9
3.1.1 Activation of the Status indication	9
3.1.2 Activation of the logic blocks	9
3.1.3 Activation of the Device diagnosis object	10
3.1.4 Restore ETS-Parameters	10
3.1.5 Status during bus power cut or download	11
3.2 Status indication	12
3.3 Logic block	14
3.3.1 Configuration of the Logic function	15
3.3.2 Logic block authorization	16
3.3.3 Logic result	18
3.4 Diagnosis	21
3.5 Function selection	23
3.5.1 Definition	23
3.5.2 ON/OFF timings function	27
3.5.2.1 Delays for ON/OFF objects	27
3.5.2.2 Timer/toggle switch changeover for ON/OFF object	29
3.5.2.3 Time limited toggle switch	30
3.5.3 Timer	31
3.5.3.1 Timer operation	31
3.5.3.2 Cut-OFF pre-warning	32
3.5.3.3 Configuration	33
3.5.4 Scene	34
3.5.5 Preset	37
3.5.6 Lock-up	41
3.5.7 Priority	45
3.5.8 Hours counter	47
4. Communication objects	50
4.1 Communication objects General	50
4.1.1 Logic block	50
4.1.2 Behaviour of the device	51
4.1.3 Diagnosis	52
4.2 Output communication objects	53
4.2.1 ON/OFF	54
4.2.2 ON/OFF timings function	54
4.2.3 Status indication	55
4.2.4 Timer	55
4.2.5 Scene	56
4.2.6 Preset	56
4.2.7 Lock-up	57
4.2.8 Priority	58
4.2.9 Hours counter	58
5. Appendix	60
5.1 Specifications	60
5.2 Table of logical operations	61
5.3 Characteristics	61

1. General

1.1 About this guide

The purpose of this manual is to describe the operation and configuration of the KNX-devices using the ETS program. It consists of 4 parts:

- General information.
- Parameter description.
- Overview of KNX objects.
- Technical characteristics.

1.2 About the program

1.2.1 ETS compatibility

The application programs are compatible with ETS4 and ETS5. They can be downloaded from our website under the order number.

ETS Version	File extension of compatible files
ETS4 (V4.1.8 or higher)	*.knxprod
ETS5	*.knxprod

1.2.2 Application descriptions

Application	Product reference
STYB601B	TYB601B

2. General Description

2.1 Installation of the device

2.1.1 Overview presentation

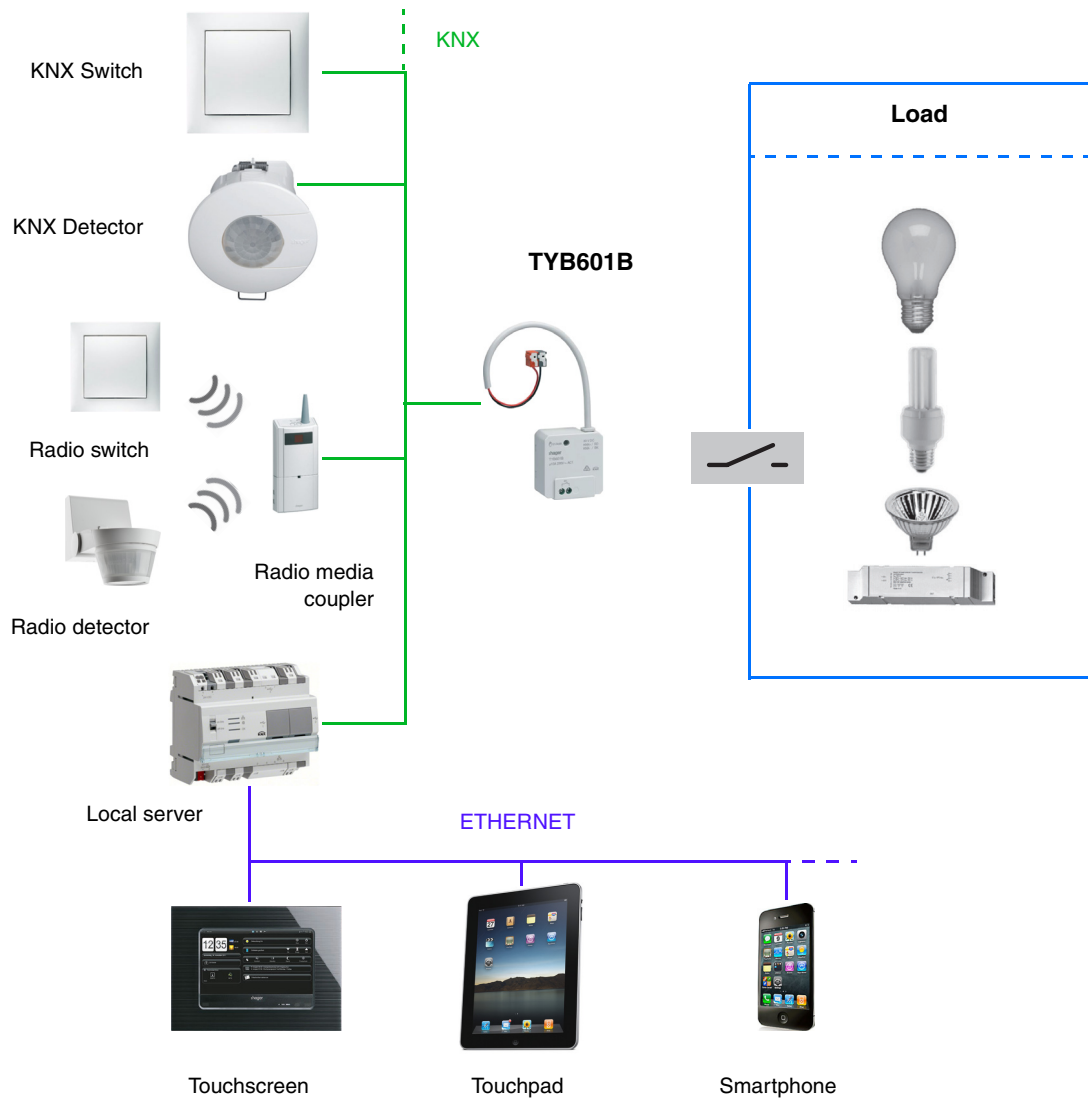

2.1.2 Description of the device

TYB601B

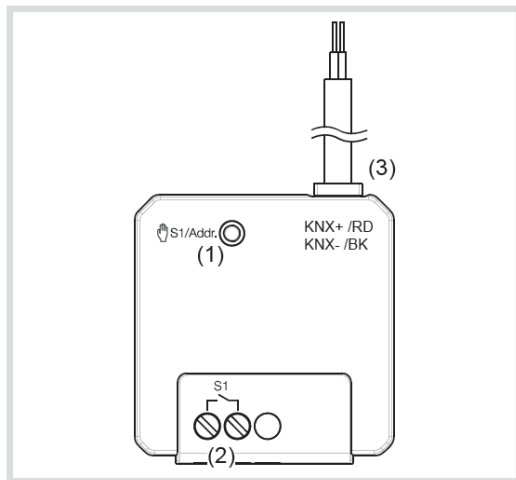

- (1) Illuminated button for manual operation/
programming button
- (2) Connection of load(s)
- (3) KNX bus connection cable

2.1.3 Physical addressing

In order to perform the physical addressing or to check whether or not the bus is connected, press the lighted push button (see chapter 2.1.2 for the button location).

Light on = bus connected and ready for physical addressing.

Programming mode is activated, until the physical address is transferred from ETS. Pressing the button again, exits programming mode. Physical addressing can be carried out in automatic or manual mode.

2.1.4 Connection

TYB601B

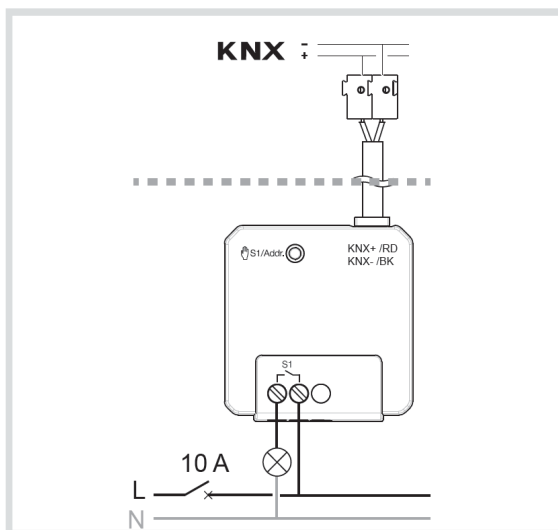

2.2 Function modules of the application

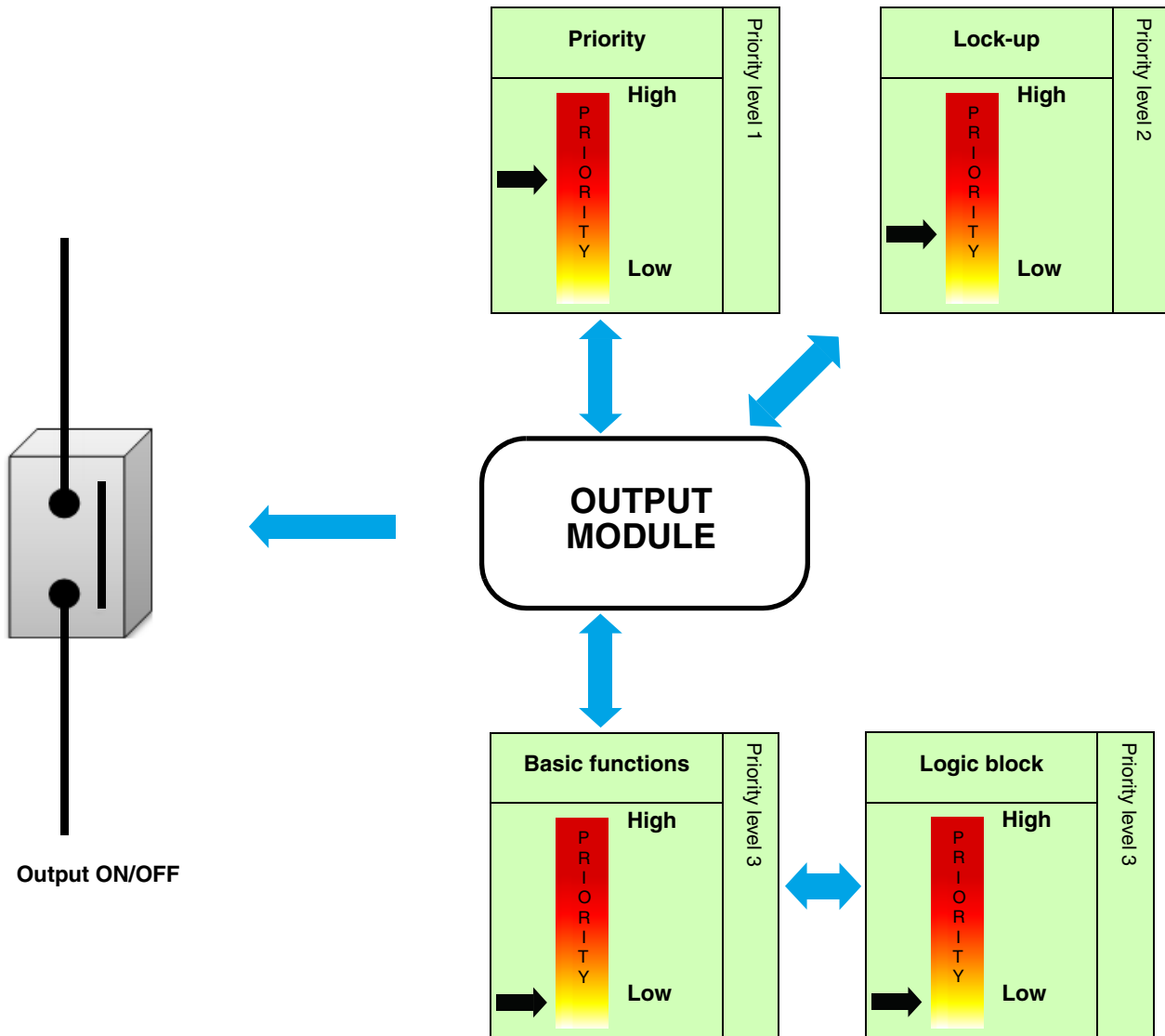

2.2.1 Primary functions

The applications allow individual configuration of the device outputs. The most important functions are:

■ ON/OFF

An output can be switched on or off using the ON/OFF function. The command can come from switches, buttons or other control inputs.

■ Timer

The Timer function is used to switch an output on or off for a programmable period. According to the selected operating mode of the timer, the output can be turned ON or OFF for a determined period of time. The timer may be interrupted before expiry of the delay time. A programmable Cut-OFF pre-warning announces the end of the delay time by a 1-second inversion of the output status. The timer duration can be modified via the bus KNX.

■ Time limited toggle switch

The Time-limited OFF function is a switching function that automatically switches off after a configurable delay time.

Application: Lighting of store rooms, cellars, sheds etc.

■ Priority

The Priority function is used to force the output into a defined state. The Priority function is controlled with a 2-bit command.

Priority: Manual mode > **Priority** > Lock-up > Basic function.

Only a Priority OFF command authorizes the output for control.

Application: Keeping lighting on for security reasons.

■ Lock-up

The Lock-up function is used to lock the output in a predefined state.

Priority: Manual mode > Priority > **Lock-up** > Basic function.

The Lock-up prevents actuation until an unlock command has been received. The Lock-up duration can be set.

■ Scene

The Scene function is used to switch groups of outputs into a configurable predefined state. A scene is activated by receipt of a 1-byte command. Each output can be included in 64 different scenes.

■ Preset

The Preset function is used to switch an output into various predefined states. The Preset function is activated via an object in 1-bit format. Each output can be controlled via 2 Preset objects.

■ Delay

The Delay functions are used to activate the outputs with a switching or tripping delay or with a switching and tripping delay.

■ Timer/toggle switch changeover

The Timer/toggle switch changeover function is used to switch between a Timer and a Toggle switch function applied to the communication object ON/OFF.

■ Hours counter

The Hours Counter function is used to count the overall operating time of an output in the ON or OFF state. The counter setpoint can be programmed and altered via an object.

2.2.2 Additional functions

The applications configure the general functions of the devices. The following functions apply to the entire device:

■ Status indication

The behaviour of the status indication of each switching channel can be configured for the entire device. The Status indication sends the switching status of the individual output contact on the KNX bus.

■ Logic block

The Logic function is used to control an output depending on the result of a logic operation. This command has the lowest priority. The result of the function can be output on the KNX bus and can directly control one or more outputs. There are 2 logic blocks per device with up to 4 inputs available.

■ Diagnosis

The Device diagnosis function allows notifications about the operating state of the device to be sent via the KNX bus. This information is sent periodically and/or on status change.

3. Parameters

3.1 Definition of the general parameters

This configuration window is used for general configuration of the device.

Output 1: General	Status indication	<input checked="" type="checkbox"/>
- O1: Status indications	Logic block 1	<input type="checkbox"/>
Output 1: Function selection	Logic block 2	<input type="checkbox"/>
Information	Status during bus power cut	Maintain status ▼
	Status at bus return	Maintain status ▼
	Status after ETS download	Maintain status ▼
	Device diagnosis object	<input type="checkbox"/>
	Activ. of restore ETS-parameters object (scenes, timer, setpoints)	<input type="checkbox"/>
	Parameters overwrite at next download (scenes)	<input checked="" type="checkbox"/>

3.1.1 Activation of the Status indication

Parameter	Description	Value
Status indication	The Status indications parameter register is hidden.	Not active
	The Status indications parameter register is displayed.	Active*

For configuration see section: [Status indication](#).

3.1.2 Activation of the logic blocks

Parameter	Description	Value
Logic block 1	Communication object and parameter register Logic block 1 are hidden.	Not active*
	Communication object and parameter register Logic block 1 are displayed.	Active

For configuration see section: [Logic block](#).

Note: The parameters and objects are identical for block 2 ; Only the terms will be adjusted.

For logic block 1

Communication objects: [23 - Logic block 1 - Input 1 \(1 bit - 1.002 DPT_Bool\)](#)
 [27 - Logic block 1 - Logic result \(1 bit - 1.002 DPT_Bool\)](#)

* Default value

For logic block 2

Communication objects: [29 - Logic block 2 - Input 1](#) (1 bit - 1.002 DPT_Bool)
[33 - Logic block 2 - Logic result](#) (1 bit - 1.002 DPT_Bool)

3.1.3 Activation of the Device diagnosis object

Parameter	Description	Value
Device diagnosis object	The Device diagnosis parameter register and the associated communication object is hidden.	Not active*
	The Device diagnosis parameter register and the associated communication object are displayed.	Active

Communication object: [36 - Outputs 1-2 - Diagnosis](#) (6 byte - Specific)

For configuration see section: [Diagnosis](#).

3.1.4 Restore ETS-Parameters

There are 2 types of parameters in the device:

- Parameters that can only be changed via ETS.
- Parameters that can be changed via ETS or via the KNX bus.

For parameters that can be changed via ETS and via the KNX bus, 2 values are stored in the device memory: The value corresponding to the ETS-parameter and the currently used value.

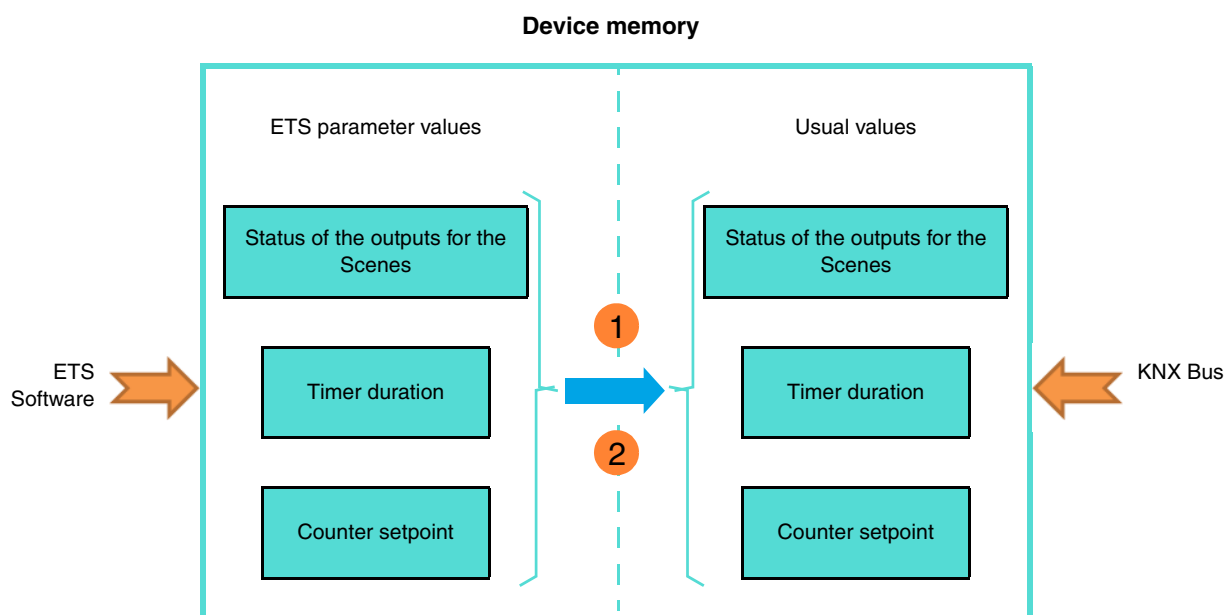

- 1 Receipt of the value 1 on the object, Resets the ETS parameter values:** Current parameter values are replaced by the ETS-parameter values.
- 2 Download of the ETS application:** Current parameter values are replaced by the ETS parameter values on download.

* Default value

Parameter	Description	Value
Activ. of restore ETS-parameters object (scenes, timer, setpoints)	The Restore ETS-params settings communication object is hidden.	Not active*
	The Restore ETS-params settings communication object is displayed.	Active
	On receipt of a 1 on this object, the parameters** that are adjustable via the bus are overwritten with values set in the ETS before the last download.	

** Output status for scene X, Timer duration, Hours counter setpoint.

Communication object: [34 - Outputs 1-2 - Restore ETS-params settings \(1 bit - 1.015 DPT_Reset\)](#)

Parameter	Description	Value
Parameters overwrite at next download (scenes)	The parameter values stored in the device will remain in the device at the next download.	Not active
	The parameter values stored in the device will be overwritten with the ETS configured values at the next download.	Active*

3.1.5 Status during bus power cut or download

Parameter	Description	Value
Status during bus power cut	The output status remains unchanged during a bus power cut.	Maintain status*
	The output is turned on when there is a bus power cut.	ON
	The output is turned off when there is a bus power cut.	OFF

Parameter	Description	Value
Status at bus return	The output status remains unchanged during at bus return.	Maintain status*
	The output is switched on at bus return.	ON
	The output is switched off at bus return.	OFF

Note: The device will reboot on bus return. The Priority functions that were present before the bus power cut, are no longer active (Priority, Lock-up).

Parameter	Description	Value
Status after ETS download	The output status remains unchanged after ETS download.	Maintain status*
	The output is switched on after ETS download.	ON
	The output is switched off after ETS download.	OFF

Note: During ETS-parameters download, the outputs remain unchanged.

* Default value

3.2 Status indication

The status Indication function specifies the status of the output contact.

Output 1: General	Polarity	<input checked="" type="radio"/> 0 = OFF, 1 = ON <input type="radio"/> 0 = ON, 1 = OFF
- O1: Status indications		
Output 1: Function selection	Emission	On status change and periodically
Information	Hours	0 h
	Minutes	10 min
	Seconds	0 s
	Emission after bus power return	0 h
	Emission after bus power return	0 min
	Emission after bus power return	20 s

Parameter	Description	Value
Polarity	The Status indication ON/OFF communication object sends: 0 = For an open output contact 1 = For a closed output contact 0 = For a closed output contact 1 = For an open output contact	0 = OFF, 1 = ON* 0 = ON, 1 = OFF

*Note: If the Blinking function is activated, the above parameter is ignored and replaced by the **Output status during Blinking function** parameter.*

Parameter	Description	Value
Emission	The Status indication ON/OFF communication object is sent: On each output change. Periodically after a configurable time. On output change and periodically after a configurable time.	On status change* Periodically On status change and periodically

* Default value

Parameter	Description	Value
Hours (h)	This parameter determines the time between the individual transmissions of the Status indication ON/OFF object.	0 hours: 0 to 23 h
Minutes (min)		10 minutes: 0 to 59 min
Seconds (s)		0 seconds: 0 to 59 s

Note: The smallest executable time is 1 second.

*Note: This parameter is only visible if the **Emission** parameter has the following value: **Periodically** or **On status change and periodically**.*

Parameter	Description	Value
Emission after bus power return	This parameter determines the delay for emission of the Status indication ON/OFF object on return of the KNX bus after a power cut.	0 hours: 0 to 23 h 0 minutes: 0 to 59 min 20 seconds: 0 to 59 s

Note: The smallest executable time is 1 second.

Note: This parameter can be used to optimize the bus load after the return of the KNX bus voltage.

3.3 Logic block

The Logic function is used to control an output depending on the result of a logic operation. This command has the lowest priority. The result of the function can be output on the KNX bus and may directly relate to the status of one or more outputs. 2 logic blocks are available for each device.

The behaviour is determined by the following parameters:

Note: The description of the parameters is given for logic block 1. The parameters and objects are identical for logic block 2 ; Only the terms will be adjusted.

Output 1: General	Logic function type	<input type="radio"/> And <input checked="" type="radio"/> Or
- O1: Status indications	Number of logic inputs	1
- O1: Logic block 1	Inverting value of logic input 1	<input checked="" type="radio"/> Maintain status <input type="radio"/> Status inversion
- O1: Logic block 2	Value at initialization of logic input 1	Value before initialization
Output 1: Function selection	Authorization object logic block	<input checked="" type="checkbox"/>
Information	Value at initialization	Value before initialization
	Polarity	<input checked="" type="radio"/> 0 = Locked-up , 1 = Authorized <input type="radio"/> 0 = Authorized, 1 = Locked-up
	Logic result after autorisation	<input checked="" type="radio"/> Immediate emission when authorization <input type="radio"/> No immediate emission
	Emission of logic result	<input type="radio"/> By input value change <input checked="" type="radio"/> By logic result value change
	Logic result acts on outputs	<input checked="" type="checkbox"/>
	Output 1	<input checked="" type="checkbox"/>
	Action if logic result = 0	OFF
	Action if logic result = 1	ON

Operating principle of the logic block:

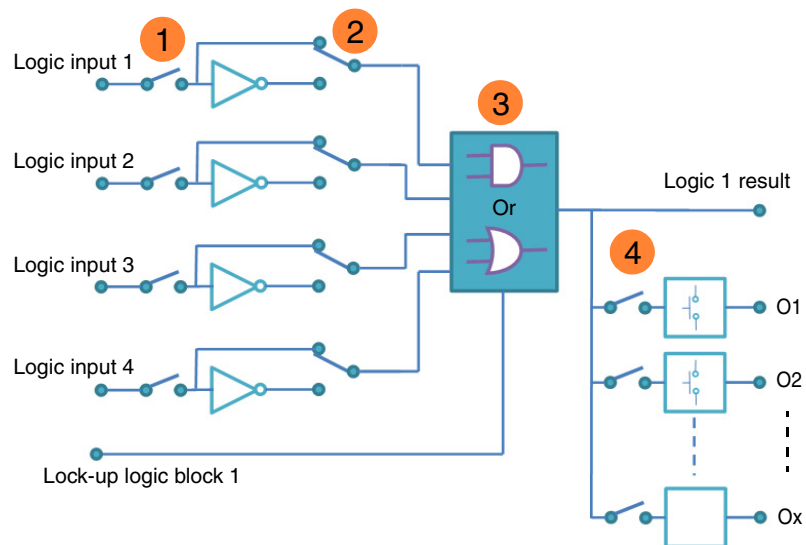

- ❶ Logic input number: Allows authorization of the logic input
- ❷ Logic input value: Inverted, yes or no
- ❸ Type of logic function (AND or OR): Selection of the logic function
- ❹ The logic result is applied to outputs: Selection of the outputs concerned by the logic operation

3.3.1 Configuration of the Logic function

Parameter	Description	Value
Logic function type	The input objects are: OR linked. AND linked.	Or* And

For logic table see: [Appendix](#).

Parameter	Description	Value
Number of logic inputs	This parameter determines the number of inputs of the logic block. Up to 4 inputs can be used.	1* 2 3 4

* Default value

- Communication objects:
- Block 1
 - 24 - Logic block 1 - Input 2 (1 bit - 1.002 DPT_Bool)
 - 25 - Logic block 1 - Input 3 (1 bit - 1.002 DPT_Bool)
 - 26 - Logic block 1 - Input 4 (1 bit - 1.002 DPT_Bool)
 - Block 2
 - 30 - Logic block 2 - Input 2 (1 bit - 1.002 DPT_Bool)
 - 31 - Logic block 2 - Input 3 (1 bit - 1.002 DPT_Bool)
 - 32 - Logic block 2 - Input 4 (1 bit - 1.002 DPT_Bool)

Parameter	Description	Value
Inverting value of logic input x	The value of logic input x works on the logic block: With its object value (0=0, 1=1). With inverted object value (0=1, 1=0).	Maintain status* Status inversion

x = 1 to 4

Parameter	Description	Value
Value at initialization of logic input x	On initialization of the device after a download or after return of the bus power, the value of the logic input is: Set to 0. Set to 1. Set according to the value of the logic input before the initialization occurred.	0 1 Value before initialization*

x = 1 to 4

3.3.2 Logic block authorization

Principle of logic block authorization:

The parameters are set as follows:

- Logic block authorization: 0 = Locked-up, 1 = Authorized.
- Action if logic result = 0 : Scene 1.
- Action if logic result = 1 : Scene 2.
- Logic input 1 and 2 are AND-linked.

Emission of logic result: By input value change.

* Default value

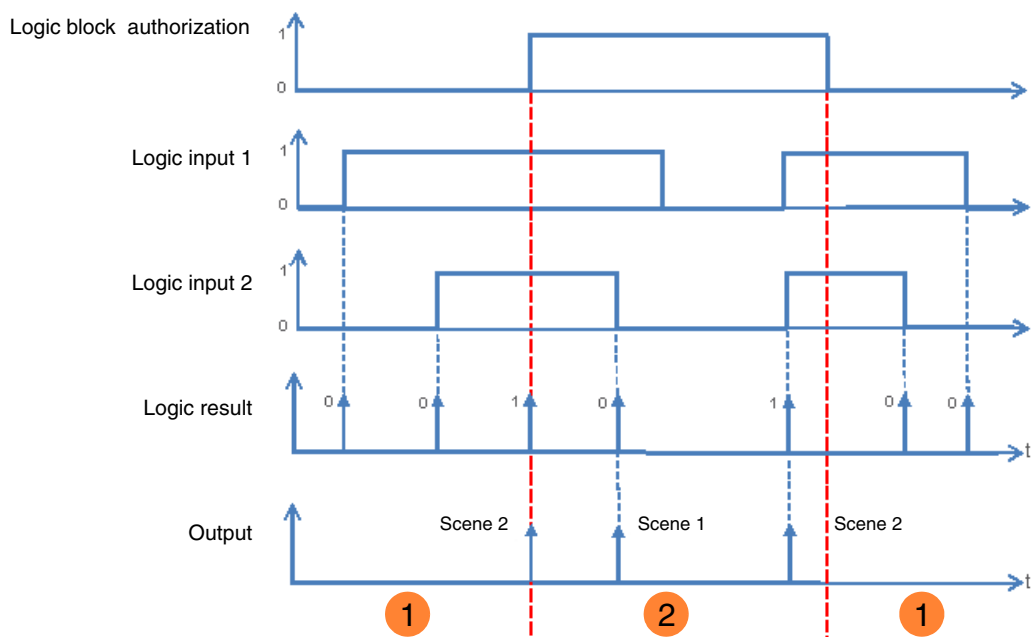

- ❶ The logic result has no influence on the outputCurrent values.
- ❷ The commands from the logic result are executed.

*Note: The commands from the logic result are executed immediately after authorization, according to the **Logic result after authorization** parameter.*

Parameter	Description	Value
Authorization object logic block	The Logic block 1 – Authorization communication object and related parameters are hidden.	Not active*
	The Logic block 1 – Authorization communication object and related parameters are displayed.	Active

Note: If the logic block is locked the logic operation is not processed.

Communication objects:

- Block 1 **22 - Logic block 1 - Authorization (1 bit - 1.003 DPT_Enable)**
- Block 2 **28 - Logic block 2 - Authorization (1 bit - 1.003 DPT_Enable)**

Parameter	Description	Value
Value at initialization	On initialization of the device after a download or after return of the bus power, the value of the Logic block 1 – Authorization object is: Set to 0. Set to 1. Set according to the value that the object had before initialization.	0 1 Value before initialization*

*Note: This parameter is only visible if the **Authorization object logic block** parameter has the following value: **Active**.*

* Default value

Parameter	Description	Value
Polarity	On receipt of a value on the Logic block 1 – Authorization object, this is: Locked-up on object value 1. Locked-up on object value 0.	0 = Authorized, 1 = Locked-up 0 = Locked-up, 1 = Authorized*

Note: This parameter is only visible if the **Authorization object logic block** parameter has the following value: **Active**.

Parameter	Description	Value
Logic result after autorisation	On authorization of the logic block: The value of the Logic result is immediately determined. The value of the logic result is first determined after receipt of a value on a logic input.	Immediate emission when authorization* No immediate emission

Note: This parameter is only visible if the **Authorization object logic block** parameter has the following value: **Active**.

3.3.3 Logic result

Parameter	Description	Value
Emission of logic result	The Logic result object will be sent on: Each receipt of a telegram on one of the logic inputs. A change in the value of the logic result.	By input value change By logic result value change*

Parameter	Description	Value
Logic result acts on outputs	The logic results acts: Only on the Logic result communication object. On the Logic result communication object and directly on one or more outputs.	Not active* Active

The status of the affected outputs is determined by the parameter **action on logic result = x**.

Parameter	Description	Value
Output 1 ... x	The output relationship with the Logic result is: Directly dependent. Independent.	Yes* No

Note: This parameter is only visible if the **Logic result acts on outputs** parameter has the following value: **Active**.

* Default value

Parameter	Description	Value
Action if logic result = 0	<p>On the outputs that are directly dependent on Logic result, if the output value = 0, the status:</p> <p>Not changed.</p> <p>Is switched to the opposite status.</p> <p>Selectively switched on.</p> <p>Selectively switched off.</p> <p>Starts timer mode.</p> <p>Stops timer mode.</p> <p>Starts one of the 64 scenes.</p> <p>Adopts the default value given by the parameter Status if preset 1 object = 0.</p> <p>Adopts the default value given by the parameter Status if preset 2 object = 0.</p>	<p>Maintain status</p> <p>Inversion</p> <p>ON</p> <p>OFF*</p> <p>Timer start</p> <p>Timer stop</p> <p>Scene number</p> <p>Preset 1</p> <p>Preset 2</p>

Note: The Timer mode, Scene function or Preset function of the selected output must be configured. If this is not the case, the status remains unchanged.

Parameter	Description	Value
Scene if logic result = 0	This parameter determines the scene number that is activated if the logic result is 0 after re-evaluation.	<p>Scene 1 ... 64</p> <p>Default value: 1</p>

The outputs respond according to the scene numbers and associated parameters.

*Note: This parameter is only visible if the **Action if logic result = 0** parameter has the following value: **Scene number**.*

Parameter	Description	Value
Action if logic result = 1	<p>On the outputs that are directly dependent on Logic result, if the output value = 1, the status:</p> <p>Not changed.</p> <p>Is switched to the opposite status.</p> <p>Selectively switched on.</p> <p>Selectively switched off.</p> <p>Starts timer mode.</p> <p>Stops timer mode.</p> <p>Starts one of the 64 scenes.</p> <p>Adopts the default value given by the parameter Status if preset 1 object = 1.</p> <p>Adopts the default value given by the parameter Status if preset 2 object = 1.</p>	<p>Maintain status</p> <p>Inversion</p> <p>ON*</p> <p>OFF</p> <p>Timer start</p> <p>Timer stop</p> <p>Scene number</p> <p>Preset 1</p> <p>Preset 2</p>

Note: The Timer mode, Scene function or Preset function of the selected output must be configured. If this is not the case, the status remains unchanged.

* Default value

Parameter	Description	Value
Scene if logic result = 1	This parameter determines the scene number that is activated if the logic result is 1 after re-evaluation.	Scene 1 ... 64 Default value: 2

The outputs respond according to the scene numbers and associated parameters.

*Note: This parameter is only visible if the **Action if logic result = 1** parameter has the following value: **Scene number**.*

3.4 Diagnosis

The **Device diagnosis** object allows notifications about the operating status of the device to be sent via the KNX bus. This information is sent periodically and/or on status change.

The **Device diagnosis** object allows reporting of current faults according to the device and application. It also allows sending of the position of the switch on the front of the device and the number of the output that is affected by the fault(s).

The **Device Diagnosis** object is a 6-byte object that is composed as described below:

Byte number	6 (MSB)	5	4	3	2	1 (LSB)
Use	Switch position	Application type	Output number	Error codes		

Details of the byte:

- **Bytes 1 to 4:** Correspond to the error codes.

b31	b30	b29	b28	b27	b26	b25	b24	b23	b22	b21	b20	b19	b18	b17	b16	b15	b14	b13	b12	b11	b10	b9	b8	b7	b6	b5	b4	b3	b2	b1	b0
32	X	X	X	28	27	X	X	X	X	X	X	X	X	X	X	X	X	X	X	X	X	X	9	X	X	X	X	X	X	X	X

N°	Faults
27	Wrong context: The user's parameters are not transferable. The standard parameters are restored.
28	TP communication out of operation: Communication via the KNX bus was not available on the previous start.
32	Minimum switching time not complied with: The device is equipped with a mechanism for limiting the number of switching cycles per minute of the output contact. If the user requires a number of switching cycles that is greater than this limit, this bit informs the user that his command was not carried out.
9	Excessive number of restarts: This bit is use for notification of repeated restarts and/or a restart triggered by a Watch-Dog. Such a restart is not necessarily apparent to the user from the function, rather it is manifest as a disturbed environment or a bad contact of the power supply.

Note: The use of the standard bit depends on the type of device used (switch actuator, dimmer, shutter/blind, etc.). Certain bit are same for all devices and others are application-specific.

- **Byte 5:** Corresponds to the application type and the number of the output affected by the error.

MSB				LSB			
b7	b6	b5	b4	b3	b2	b1	b0
Application type				Output number			
0 = Not defined				0 = Device error			
1 = Switch actuator				1 = Output 1			
2 = Shutter/blind				2 = Output 2			
3 = Dimmer						
				Y = Output Y			

Note: Y is the placeholder for the maximum number of outputs.

- **Byte 6:** Switch position.

MSB				LSB			
b7	b6	b5	b4	b3	b2	b1	b0
X	X	X	X	X	X	X	1

1: 0 = Automatic mode / 1 = Manual mode

Note: Bit marked with an x are not used.

Output 1: General	Emission	On status change and periodically
- O1: Status indications	Hours	0 h
- O1: Device diagnosis	Minutes	30 min
Output 1: Function selection	Seconds	0 s
Information		

Parameter	Description	Value
Emission	The Device diagnosis communication object is sent to bus: On each change. Periodically after a configurable time. On change and periodically after a configurable time.	On status change* Periodically On status change and periodically

Parameter	Description	Value
Hours (h)	This parameter determines the time between the individual transmissions of the Device diagnosis object.	0 hours: 0 to 23 h
Minutes (min)		30 minutes: 0 to 59 min
Seconds (s)		0 seconds: 0 to 59 s

Note: The smallest executable time is 1 second.

*Note: This parameter is only visible if the **Emission** parameter has the following value: **Periodically** or **On status change and periodically**.*

* Default value

3.5 Function selection

This parameter window is used to set the device outputs. These parameters are available individually for each output.

Output 1: General	Output contact	<input checked="" type="radio"/> Normally open <input type="radio"/> Normally closed
- O1: Status indications	Status indication ON/OFF	<input checked="" type="checkbox"/>
- O1: Device diagnosis	ON/OFF timings function	<input type="checkbox"/>
	Timer	<input type="checkbox"/>
Output 1: Function selection	Scene	<input type="checkbox"/>
Information	Preset	Not active
	Lock-up	Not active
	Priority	<input type="checkbox"/>
	Hours counter	<input type="checkbox"/>

3.5.1 Definition

Parameter	Description	Value
Output contact	On receipt of an ON command: The output relay closes. The output relay opens.	Normally open* Normally closed

Principle:

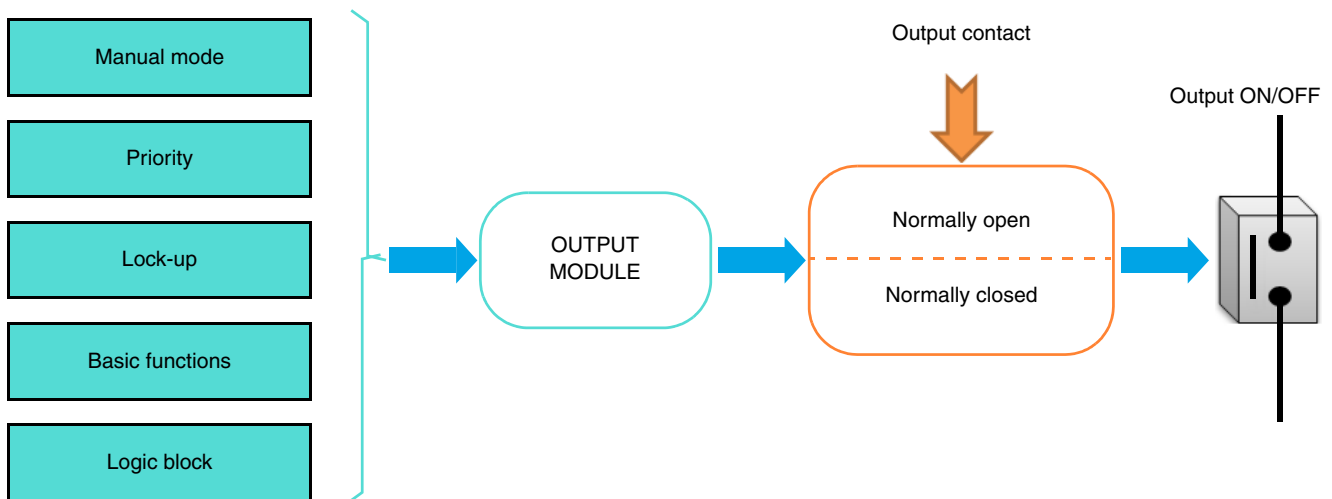

* Default value

Parameter	Description	Value
Status indication ON/OFF	The Status indication ON/OFF communication object is: Hidden. Displayed, the status indication can be transmitted over the bus.	No Yes*

Communication objects: [3 - Output 1 - Status indication ON/OFF \(1 bit - 1.001 DPT_Switch\)](#)

*Note: The transmission conditions for the Status indication objects must be set in the parameter Register **O1-Ox: Status indication**.*

Parameter	Description	Value
ON/OFF timings function	The ON/OFF timings function tab and the associated parameters and objects are: Hidden. Displayed.	Not active* Active

For configuration see section: [ON/OFF timings function](#).

Parameter	Description	Value
Timer	The Timer tab and the associated parameters and objects are: Hidden. Displayed.	Not active* Active

Communication objects: [4 - Output 1 - Timer \(1 bit - 1.001 DPT_Switch\)](#)

For configuration see section: [Timer](#).

Parameter	Description	Value
Scene	The Scenes tab and the associated parameters and objects are: Hidden. Displayed.	Not active* Active

Communication objects: [6 - Output 1 - Scene \(1 byte - 17.001 DPT_SceneNumber\)](#)

For configuration see section: [Scene](#).

* Default value

Parameter	Description	Value
Preset	The Preset tab and the associated parameters and objects are: Hidden. Displayed for 1 Preset object. Displayed for 2 Preset objects.	Not active* Active with preset 1-level object Active with preset 2-level objects

Note: When the value of this parameter changes, the associated parameters and group addresses are deleted.

Preset 1 communication Objets [7 - Output 1 - Preset 1 \(1 bit - 1.022 DPT_Scene_AB\)](#)

Preset 2 communication Objets [8 - Output 1 - Preset 2 \(1 bit - 1.022 DPT_Scene_AB\)](#)

For configuration see section: [Preset](#).

Parameter	Description	Value
Lock-up	The Lock-up tab and the associated parameters and objects are: Hidden. Displayed for 1 lock-up object. Displayed for 2 lock-up objects.	Not active* 1 lock-up object 2 lock-up objects

Lock-up 1 communication objects [11 - Output 1 - Lock-up 1 \(1 bit - 1.003 DPT_Enable\)](#)

Lock-up 2 communication objects [12 - Output 1 - Lock-up 2 \(1 bit - 1.003 DPT_Enable\)](#)

For configuration see section: [Lock-up](#).

Parameter	Description	Value
Priority	The Priority tab and the associated parameters and objects are: Hidden. Displayed.	Not active* Active

* Default value

The device responds to telegrams received via the **Priority** object, as given in the following table:

Telegram received by the priority operation object			Output behaviour
Hexadecimal Value	Binary Value		
	Bit 1 (MSB)	Bit 0 (LSB)	
00	0	0	End of the priority
01	0	1	End of the priority
02	1	0	Priority OFF
03	1	1	Priority ON

Communication objects: [14 - Output 1 - Priority \(2 bit - 2.002 DPT_Bool_Control\)](#)

For configuration see section: [Priority](#).

Parameter	Description	Value
Hours counter	The Hours counter tab and the associated parameters and objects are: Hidden. Displayed.	Not active* Active

A telegram can be transmitted via the **Hours counter setpoint reached** object, in accordance with a programmable setpoint.

It is also possible to reset the count value via a 1 signal on the **Reset hours counter value** object.

Communication objects:

[16 - Output 1 - Hours counter value \(2 byte - 7.001 DPT_16_bit_Counter\)](#)

[17 - Output 1 - Reset hours counter value \(1 bit - 1.015 DPT_Reset\)](#)

[18 - Output 1 - Hours counter setpoint reached \(1 bit - 1.002 DPT_Bool\)](#)

For configuration see section: [Hours counter](#).

* Default value

3.5.2 ON/OFF timings function

Output 1: General	Delays for ON/OFF objects	Switching and tripping delay
- O1: Status indications	Switching delay	0 h
- O1: Device diagnosis	Switching delay	3 min
Output 1: Function selection	Switching delay, minimum value 1s	0 s
- O1: ON/OFF object timings	Tripping delay	0 h
Information	Tripping delay	3 min
	Tripping delay, minimum value 1s	0 s
	Timer/toggle switch changeover for object ON/OFF	<input checked="" type="checkbox"/>
	Hours	1 h
	Minutes	0 min
	Second (s), minimum value 1s	0 s
	Additional time limited toggle switch function	<input checked="" type="checkbox"/>
	Hours	1 h
	Minutes	0 min
	Second (s), minimum value 1s	0 s

3.5.2.1 Delays for ON/OFF objects

Parameter	Description	Value
Delays for ON/OFF objects	The parameters for time-delayed switching of the outputs are: Hidden. Displayed for Switching delay. Displayed for Tripping delay. Displayed for Switching and tripping delay.	Not active* Switching delay Tripping delay Switching and tripping delay

* Default value

Switching delay: Allows the configuration of a delay between the switch-on command and the switching of the output contact.

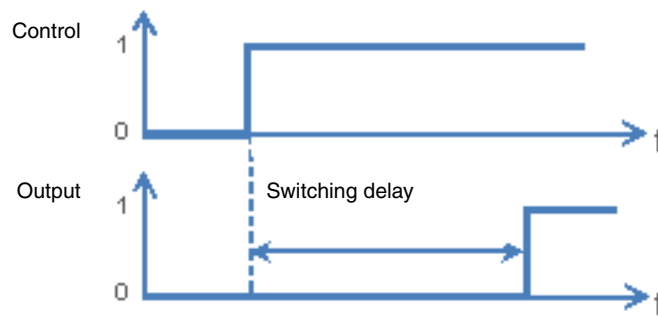

Tripping delay: Allows the configuration of a delay between the switch-off command and the switching of the output contact.

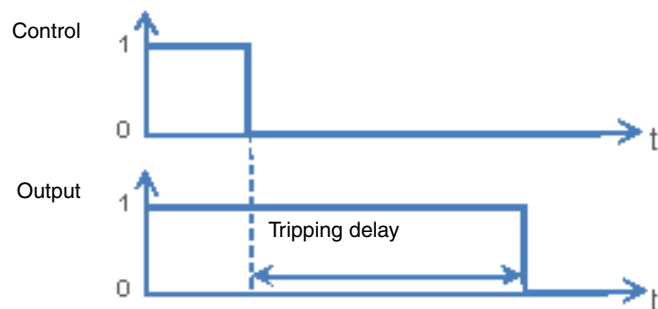

Switching and tripping delay: Allows the configuration of a delay between the switch-on command and the switching of the output contact, as well as between the switch-off command and the switching of the output contact.

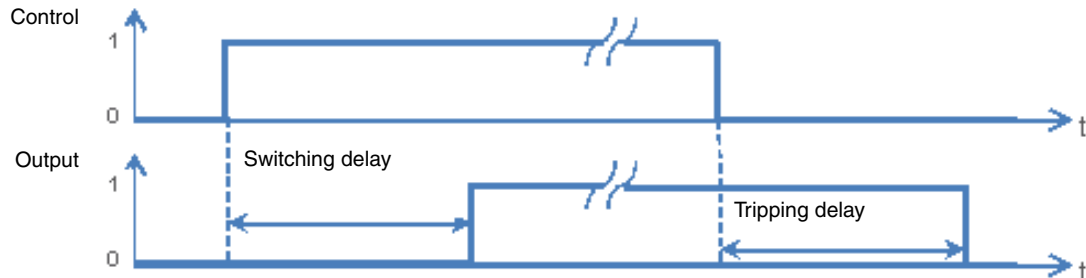

Parameter	Description	Value
Switching delay	This parameter defines the delay between the switch-on command and the switching of the output contact.	0 hours: 0 to 23 h 3 minutes: 0 to 59 min 0 seconds: 0 to 59 s

Note: The smallest executable time is 1 second.

*Note: This parameter is only visible if the **Delays for ON/OFF** objects parameter has the following value: **Switching delay** or **Switching and tripping delay**.*

Parameter	Description	Value
Tripping delay	This parameter defines the delay between the switch-off command and the switching of the output contact.	0 hours: 0 to 23 h 3 minutes: 0 to 59 min 0 seconds: 0 to 59 s

Note: The smallest executable time is 1 second.

Note: This parameter is only visible if the **Delays for ON/OFF objects** parameter has the following value: **Tripping delay or Switching and tripping delay**.

3.5.2.2 Timer/toggle switch changeover for ON/OFF object

This function switches the output channels between toggle switch and timer mode for the **ON/OFF** object.

Example: Switching function daytime and Time-limited OFF function at night.

During the day, the button is used as a switch. In the evenings, the button is used as a time-limited OFF switch, so that the light will turn off automatically.

Parameter	Description	Value
ON/OFF	The parameters for a switch-over between toggle switch and timer modes for the ON/OFF object are: Hidden. Displayed.	Not active* Active

- If the **Timer/toggle switch changeover** object receives the value 1, the Toggle-switch mode function is activated. The ON/OFF switching of the output is performed as usual via the **ON/OFF** object.
- If the **Timer/toggle switch changeover** object receives the value 0, the Timer mode function is activated.
 - If the **ON/OFF** object receives the value 1, the output is switched ON. After expiry of a configurable time, the output is automatically switched OFF.
 - If the **ON/OFF** object receives the value 0, the output is switched OFF.

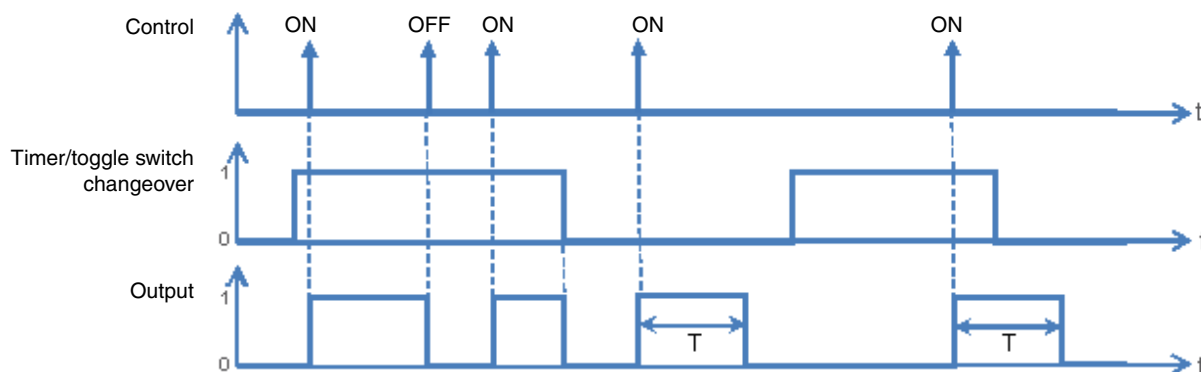

Communication objects: [1 - Output 1 - Timer/toggle switch changeover \(1 bit - 1.001 DPT_Switch\)](#)

Parameter	Description	Value
Hours (h)	This parameter sets the length of the timer operation, if this is activated.	1 hours: 0 to 23 h
Minutes (min)		0 minutes: 0 to 59 min
Seconds (s)		0 seconds: 0 to 59 s

Note: The smallest executable time is 1 second.

Note: This parameter is only visible if the **Timer/toggle switch changeover parameter for the ON/OFF object** has the following value: **Active**.

* Default value

3.5.2.3 Time limited toggle switch

The Time-limited OFF function enables automatic switch off after a programmable Time-limited OFF time. The output works as a normal switch actuator but is switched off after a given time for security.

Example: Attic, the lighting can be switched normally but switches off after not more than 3 hours.

Parameter	Description	Value
Additional time limited toggle switch function	The parameters for setting the Time-limited OFF time are: Hidden. Displayed.	Not active* Active

Function diagram

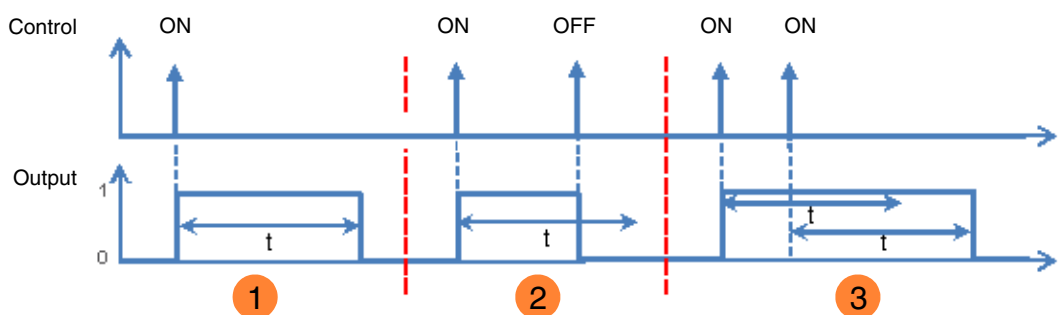

- 1 Emission of an ON command: The output which is at ON will switch to OFF on expiry of the Time-limited OFF time.
- 2 Emission of an ON command: The output switches to ON.
Emission of an OFF command before expiry of the Time-limited OFF time, t : The output switches to OFF.
- 3 Emission of an ON command: The output switches to ON.
Emission of an ON command before expiry of the Time-limited OFF time, t : The output remains at ON and the Time-limited OFF time, t , is re-started.

Communication objects: [2 - Output 1 - Time limited toggle switch object \(1 bit - 1.001 DPT_Switch\)](#)

Parameter	Description	Value
Hours (h)	This parameter sets the length of the timer operation for the Time-limited toggle switch, if this is activated.	1 hours: 0 to 23 h
Minutes (min)		0 minutes: 0 to 59 min
Seconds (s)		0 seconds: 0 to 59 s

Note: The smallest executable time is 1 second.

*Note: This parameter is only visible if the **Additional time limited toggle switch function** parameter has the following value: **Active**.*

* Default value

3.5.3 Timer

The Timer function can switch a lighting circuit on or off for a configurable period. According to the selected operating mode of the timer, the output can be turned ON or OFF for a determined period of time. The timer may be interrupted before expiry of the delay time. A programmable Cut-OFF pre-warning announces the end of the delay time by a 1-second inversion of the output status.

Output 1: General	Timer operation	ON
- O1: Status indications	Timer duration	0 h
- O1: Device diagnosis	Timer duration	3 min
Output 1: Function selection	Timer duration (s), minimum value 1s	0 s
- O1: Timer		
Information	Cut-OFF pre-warning	<input checked="" type="checkbox"/>
	Hours	0 h
	Minutes	0 min
	Seconds	30 s
	Timer interruption	<input type="radio"/> No <input checked="" type="radio"/> Yes
	Timer retriggerability	<input checked="" type="checkbox"/>
	Timer duration extension (10 first seconds)	Unlimited
	Timer duration modifiable through object	<input type="checkbox"/>

3.5.3.1 Timer operation

Parameter	Description	Value
Timer operation	When the timer is active, the output for the Timer duration is: Selectively switched on. Selectively switched off. Switched alternately ON and OFF. (Blink time is configurable via additional parameters.)	ON* OFF Blinking

Parameter	Description	Value
Timer duration	This parameter determines the timer duration.	0 hours: 0 to 23 h 2 minutes: 0 to 59 min 0 seconds: 0 to 59 s

Note: The smallest executable time is 1 second.

* Default value

Parameter	Description	Value
Blinking ON duration (s)	This parameter determines the closing duration of the output contact when blinking.	5 seconds: 5 to 240 s

Note: This parameter is only visible if the **Timer operation** parameter has the following value: **Blinking**.

Parameter	Description	Value
Blinking OFF duration (s)	This parameter determines the opening duration of the output contact when blinking.	5 seconds: 5 to 240 s

Note: This parameter is only visible if the **Timer operation** parameter has the following value: **Blinking**.

Parameter	Description	Value
Output status during blinking function	When the switch actuator is blinking, the Status indication ON/OFF object sends: The value, 1 = ON. The value, 0 = OFF. The values 1 and 0 alternately. (The status object blinks accordingly.)	ON* OFF ON/OFF

Note: This parameter is only visible if the **Timer operation** parameter has the following value: **Blinking**.

3.5.3.2 Cut-OFF pre-warning

Parameter	Description	Value
Cut-OFF pre-warning	Before expiry of the timer delay there is: No warning. A warning through a 1-second inversion of the output status. The lead time of this warning can be set.	Not active Active*

Parameter	Description	Value
Hours (h)	This parameter determines the lead time of the cut-OFF pre-warning.	0 hours: 0 to 23 h
Minutes (min)		0 minutes: 0 to 59 min
Seconds (s)		30 seconds: 0 to 59 s

Note: The smallest executable time is 1 second.

Note: This parameter is only visible if the **Cut-OFF pre-warning** parameter has the following value: **Active**.

Note: If the lead time of the cut-OFF pre-warning is greater than the duration of the timer, the cut-OFF pre-warning is not triggered.

* Default value

3.5.3.3 Configuration

Parameter	Description	Value
Timer interruption	On receiving the value 0 on the Timer communication object, the timing is: Interrupted. Not interrupted.	Yes* No

Parameter	Description	Value
Timer retriggerability	The parameter Timer duration extension (10 first seconds) is: Hidden. Displayed.	No Yes*

Parameter	Description	Value
Timer duration extension (10 first seconds)	If, during the first 10 seconds of the timer duration, multiple commands with the value 1 are received on the Timer communication object, it is: Multiplied unlimited times. Multiplied a maximum of 1x. Multiplied a maximum of 2x. Multiplied a maximum of 3x. Multiplied a maximum of 4x. Multiplied a maximum of 5x.	Unlimited* 1-time duration extension 2-time duration extension 3-time duration extension 4-time duration extension 5-time duration extension

Parameter	Description	Value
Timer duration modifiable through object	The Timer duration communication object is: Hidden. Displayed, the timer duration can be transmitted via the bus.	Not active* Active

Communication objects: [5 - Output 1 - Timer duration \(3 byte - 10.001 DPT_TimeOfDay\)](#)

* Default value

3.5.4 Scene

Output 1: General	Number of scenes used	8
- O1: Status indications	Scenes memorisation by long key press	<input checked="" type="checkbox"/>
- O1: Device diagnosis	Scenes memorisation acknowledgment (Output status inverted for 3s)	<input type="checkbox"/>
Output 1: Function selection	Output status for scene 1	Not active
- O1: Scenes	Output status for scene 2	Not active
Information	Output status for scene 3	Not active
	Output status for scene 4	Not active
	Output status for scene 5	Not active
	Output status for scene 6	Not active
	Output status for scene 7	Not active
	Output status for scene 8	Not active
	Blinking ON duration (s)	5
	Blinking OFF duration (s)	5
	Output status during blinking function	ON

Parameter	Description	Value
Number of scenes used	This parameter determines the number of scenes used.	8* - 16 - 24 - 32 - 48 - 64

Note: If the Scene number received on the Scene object is greater than the maximum number of scenes, the status of the output remains unchanged.

Parameter	Description	Value
Scenes memorisation by very long key press	This parameter allows learning and storing of a scene by, for example, a long press (> 5 seconds) of the corresponding push button.	Not active Active*

Learning and storing scenes

This process is used to change and store a scene. For example, by locally pressing the key in the room or by emission of the values from a visualization.

* Default value

To access and store scenes, the following values must be sent:

Scene number	Access scene (Object value: 1 byte)	Store scene (Object value: 1 byte)
1 - 64	= Scene number - 1	= Scene number + 128
Example		
1	0	128
2	1	129
3	2	130
...	...	
64	63	191

Here is the scene memorisation for local switches, for example.

- Activate scene by briefly pressing the transmitter that starts it.
- The outputs (lights, shutters, etc.) are set in the desired state using the usual local control devices (buttons, remote control, etc.).
- Memorise the status of the outputs with a press greater than 5 seconds long on the transmitter that starts the scene. The memorisation can be displayed by short-term activation of the outputs.

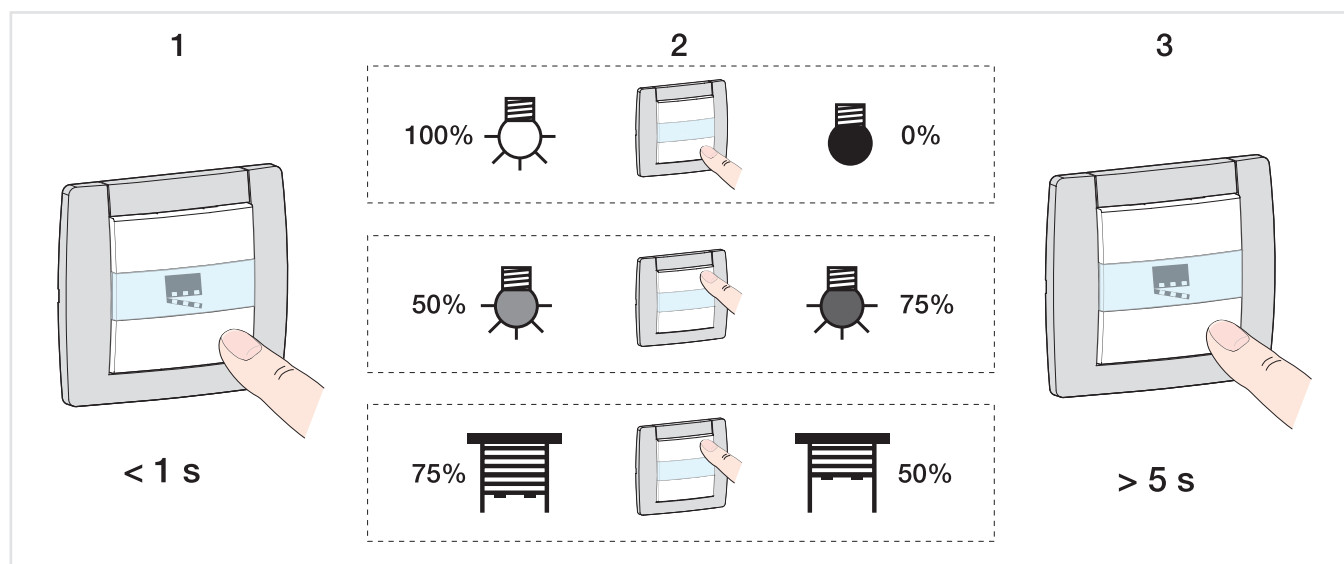

Parameter	Description	Value
Scenes memorisation acknowledgment	Memorisation of a scene is: Not acknowledged. Acknowledged by the output by a 3 second long inversion of the output status.	Not active* Active

* Default value

Parameter	Description	Value
Output status for scene X	On activation of Scene X, the output is: Not changed. Selectively switched on. Selectively switched off. Switched alternately ON and OFF. (Blink time is configurable via additional parameters.)	Not active* ON OFF Blinking

X = 1 to 64

*Note: Each output has up to 64 scenes available, in accordance with the **Number of scenes used** parameter.*

*Note: Local storage of the scene is not recorded if the **Output status for scene X** parameter is not active or is blinking.*

Parameter	Description	Value
Blinking ON duration (s)	This parameter determines the closing duration of the output contact when blinking.	5 seconds : 5 to 240 s

*Note: This parameter applies to all scenes involving the respective output, which has the following value: **Blinking**.*

Parameter	Description	Value
Blinking OFF duration (s)	This parameter determines the opening duration of the output contact when blinking.	5 seconds : 5 to 240 s

*Note: This parameter applies to all scenes involving the respective output, which has the following value: **Blinking**.*

Parameter	Description	Value
Output status during blinking function	When the switch actuator is blinking, the Status indication ON/OFF object sends: The value, 1 = ON. The value, 1 = OFF. The values 1 and 0 alternately. (The status object blinks accordingly.)	ON* OFF ON/OFF

*Note: This parameter applies to all scenes involving the respective output, which has the following value: **Blinking**.*

* Default value

3.5.5 Preset

Output 1: General	Preset authorization objects	<input checked="" type="checkbox"/>
- O1: Status indications	Value of authorization preset 1 at initialization	Value before initialization
- O1: Device diagnosis	Value of authorization preset 2 at initialization	Value before initialization
Output 1: Function selection	Polarity of Preset 1 authorization object	<input checked="" type="radio"/> 0 = Locked-up , 1 = Authorized <input type="radio"/> 0 = Authorized, 1 = Locked-up
- O1: Preset	Polarity of Preset 2 authorization object	<input checked="" type="radio"/> 0 = Locked-up , 1 = Authorized <input type="radio"/> 0 = Authorized, 1 = Locked-up
Information	Status if preset 1 object = 0	Scene number
	Scene for preset 1 = 0	1
	Status if preset 1 object = 1	Blinking
	Blinking ON duration (s)	5 s
	Blinking OFF duration (s)	5 s
	Output status during blinking function	ON
	Status if preset 2 object = 0	Maintain status
	Status if preset 2 object = 1	Maintain status

The Preset function is used to switch an output into various predefined states. The Preset function is activated via an object in 1-bit format.

Principle of Preset authorization:

The parameters are set as follows:

- Polarity of Preset 1 authorization object: 0 = Locked-up, 1 = Authorized.
- Polarity of Preset 2 authorization object: 0 = Locked-up, 1 = Authorized.
- Status if preset 1 object = 0: ON.
- Status if preset 1 object = 1: OFF.
- Status if preset 2 object = 0: Scene 1.
- Status if preset 2 object = 1: Scene 2.

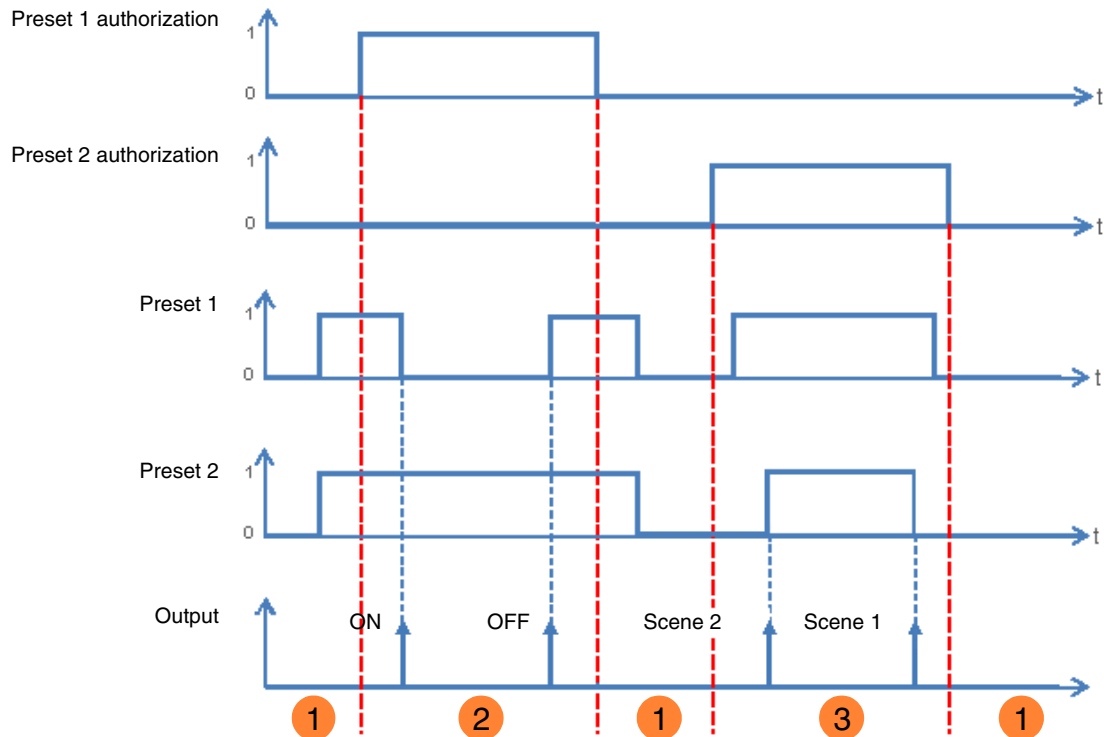

- ❶ The preset inputs have no influence on the output.
- ❷ The commands from Preset 1 are executed.
- ❸ The commands from Preset 2 are executed.

Note: The commands from the Preset will not be executed immediately after authorization, but only when the value of the Preset changes.

Parameter	Description	Value
Preset authorization objects	The Preset 1 authorization communication object and the related parameters are: Hidden. Displayed. This object allows the authorization or lock-up of the Preset 1 function via a KNX telegram.	Not active* Active

*Note: The number of available Preset objects is dependent on the **Preset** parameter. A maximum of two of these objects can be available.*

Communication objects: [9 - Output 1 - Preset 1 authorization \(1 bit - 1.003 DPT_Enable\)](#)

* Default value

Communication objects: **10 - Output 1 - Preset 2 authorization (1 bit - 1.003 DPT_Enable)**

Note: The parameters and objects are identical for Preset 2 ; Only the terms will be adjusted.

Parameter	Description	Value
Value of authorization preset 1 at initialization	On initialization of the device after a download or after return of the bus power, the value of the Preset 1 authorization object is: Set to 0. Set to 1. Set according to the value of the logic input before the initialization occurred.	0 1 Value before initialization*

*Note: This parameter is only visible if the **Preset authorization objects** parameter has the following value: **Active**.*

Parameter	Description	Value
Polarity of Preset 1 authorization object	On receipt of a value on the Preset 1 authorization object, Preset 1 : Locked-up on object value 1. Locked-up on object value 0.	0 = Locked-up, 1 = Authorized* 0 = Authorized, 1 = Locked-up

*Note: This parameter is only visible if the **Preset authorization objects** parameter has the following value: **Active**.*

Parameter	Description	Value
Status if preset 1 object = 0	On receipt of the value 0 on the Preset 1 object, the output is: Not changed. Is switched to the opposite status. Selectively switched on. Selectively switched off. Set to a scene value. Set in blinking mode. Switched to the status that was active before last receiving the value 1 on the Preset 1 object.	Maintain status* Inversion ON OFF Scene number Blinking Status before preset 1 = 1

Parameter	Description	Value
Scene for preset 1 = 0	This parameter determines the value of the scene if: The Preset 1 object has value 0. The Status if preset 1 object = 0 object has the scene value.	Scene 1 ... 64 Default value: 1

* Default value

Parameter	Description	Value
Status if preset 1 object = 1	<p>On receipt of the value 1 on the Preset 1 object, the output is:</p> <p>Not changed.</p> <p>Is switched to the opposite status.</p> <p>Selectively switched on.</p> <p>Selectively switched off.</p> <p>Set to a scene value.</p> <p>Set in blinking mode.</p> <p>Switched to the status that was active before last receiving the value 1 on the Preset 1 object.</p>	<p>Maintain status*</p> <p>Inversion</p> <p>ON</p> <p>OFF</p> <p>Scene number</p> <p>Blinking</p> <p>Status before preset 1 = 0</p>

Parameter	Description	Value
Scene for preset 1 = 1	<p>This parameter determines the value of the scene if:</p> <p>The Preset 1 object has value 1.</p> <p>The Status if preset 1 object = 1 object has the scene value.</p>	<p>Scene 1 ... 64</p> <p>Default value: Scene 2</p>

Parameter	Description	Value
Blinking ON duration (s)	This parameter determines the closing duration of the output contact when blinking.	5 seconds: 5 to 240 s

*Note: This parameter is only visible if the **Status if preset 1 object = 0** parameter or the **Status if preset 1 object = 1** parameter has the following value: **Blinking**.*

Parameter	Description	Value
Blinking OFF duration (s)	This parameter determines the opening duration of the output contact when blinking.	5 seconds: 5 to 240 s

*Note: This parameter is only visible if the **Status if preset 1 object = 0** parameter or the **Status if preset 1 object = 1** parameter has the following value: **Blinking**.*

Parameter	Description	Value
Output status during blinking function	<p>When the switch actuator is blinking, the Status indication ON/OFF object sends:</p> <p>The value, 1 = ON.</p> <p>The value, 0 = OFF.</p> <p>The values 1 and 0 alternately. (The status object blinks accordingly.)</p>	<p>ON*</p> <p>OFF</p> <p>ON/OFF</p>

*Note: This parameter is only visible if the **Status if preset 1 object = 0** parameter or the **Status if preset 1 object = 1** parameter has the following value: **Blinking**.*

* Default value

3.5.6 Lock-up

Output 1: General	Lock-up type	<input checked="" type="radio"/> Output lock-up <input type="radio"/> Object lock-up
- O1: Status indications	Lock-up duration	<input type="radio"/> Time limited <input checked="" type="radio"/> Permanently
- O1: Device diagnosis	Priority between lock-up 1 and lock-up 2	Lock-up 1 > Lock-up 2
Output 1: Function selection	Activation of lock-up status object	<input checked="" type="checkbox"/>
- O1: Lock-up	Polarity	<input checked="" type="radio"/> 0 = Lock-up deactivated, 1 = Lock-up activated <input type="radio"/> 0 = Lock-up activated, 1 = Lock-up deactivated
Information	Emission	On status change and periodically
	Hours	0 h
	Minutes	10 min
	Seconds	0 s
	Polarity of lock-up object 1	<input checked="" type="radio"/> 0 = Lock-up deactivated, 1 = Lock-up activated <input type="radio"/> 0 = Lock-up activated, 1 = Lock-up deactivated
	Status if lock-up 1	Maintain status
	Status after lock-up function 1	Maintain status
	Polarity of lock-up object 2	<input checked="" type="radio"/> 0 = Lock-up deactivated, 1 = Lock-up activated <input type="radio"/> 0 = Lock-up activated, 1 = Lock-up deactivated
	Status if lock-up 2	Maintain status
	Status after lock-up function 2	Maintain status

The Lock-up function is used to lock the output in a predefined state.
 Priority: Manual mode > Priority > **Lock-up** > Basic function.
 The Lock-up prevents actuation until an unlock command has been received.
 The Lock-up duration can be set.

Parameter	Description	Value
Lock-up type	The Lock-up acts: Directly on the switch actuator. As long as the Lock-up is active, the output can only be controlled by higher priority commands. On selected communication objects. As long as the Lock-up is active, the output can only be controlled via specific selectable objects.	Output lock-up* Object lock-up

* Default value

Parameter	Description	Value
Lock-up duration	The duration of the Lock-up is Not time limited, the lock-up is only authorized by means of a telegram on Lock-up 1 object. Is active for a limited time, the control of the output is authorized after expiry of this time.	Permanently* Time limited

Parameter	Description	Value
Hours (h)	This parameter determines the activation time of the Lock-up.	0 hours: 0 to 23 h
Minutes (min)		15 minutes: 0 to 59 min
Seconds (s)		0 seconds: 0 to 59 s

Note: The smallest executable time is 1 second.

Note: This parameter is only visible if the **Lock-up duration** parameter has the following value: **Time limited**.

Parameter	Description	Value
Polarity of lock-up object 1	On receipt of a value on the Lock-up 1 object, the lock-up: Locked-up on object value 1. Is deactivated on object value 0. Locked-up on object value 0. Is deactivated on object value 1.	0 = Lock-up deactivated, 1 = Lock-up activated* 0 = Lock-up activated, 1 = Lock-up deactivated

Note: The parameters and objects are identical for Lock-up 2 ; Only the terms will be adjusted.

Parameter	Description	Value
Priority between lock-up 1 and lock-up 2	The priority between lock-up 1 and lock-up 2 is set as follows: Lock-up 1 has priority over lock-up 2. Lock-up 2 has priority over lock-up 1. Lock-up 1 and lock-up 2 have the same priority.	Lock-up 1 > Lock-up 2* Lock-up 1 < Lock-up 2 Lock-up 1 = Lock-up 2

Note: This parameter is only visible if the **Lock-up** parameter has the following value: **Active with 2 lock-up objects**.

Note: The priority of the Lock-up always functions in the same way, independently of the lock-up type (Output lock-up or object lock-up).

* Default value

Operating principle of the priorities:

If Lock-up 1 > Lock-up 2

Active lock-up	Activation order of Lock-up 1	Activation order of Lock-up 2
None	Lock-up 1 is activated	Lock-up 2 is activated
Lock-up 1	Lock-up 1 remains active	Despite the activation order of Lock-up 2, Lock-up 1 remains activated
Lock-up 2	Lock-up 1 is activated	Lock-up 2 remains active

If Lock-up 1 = Lock-up 2

Active lock-up	Activation order of Lock-up 1	Activation order of Lock-up 2
None	Lock-up 1 is activated	Lock-up 2 is activated
Lock-up 1	Lock-up 1 remains active	Lock-up 2 is activated
Lock-up 2	Lock-up 1 is activated	Lock-up 2 remains active

If Lock-up 1 < Lock-up 2

Active lock-up	Activation order of Lock-up 1	Activation order of Lock-up 2
None	Lock-up 1 is activated	Lock-up 2 is activated
Lock-up 1	Lock-up 1 remains active	Lock-up 2 is activated
Lock-up 2	Despite the activation order of Lock-up 1, Lock-up 2 remains activated	Lock-up 2 remains active

Parameter	Description	Value
Status if lock-up 1	If the Lock-up type is set to Output lock-up , on activation of the lock-up the output will: Not changed. Is switched to the opposite status. Selectively switched on. Selectively switched off.	Maintain status* Inversion ON OFF

Note: The parameters and objects are identical for Lock-up 2 ; Only the terms will be adjusted.

Lock-up 1 authorizes object:

The parameters listed below allow the selection of the objects for controlling the output via the nevertheless active Lock-up.

*Note: These parameters are only visible if the **Lock-up type** parameter has the following value: **Object lock-up**.*

* Default value

Parameter	Objects concerned	Value
ON/OFF	ON/OFF	Yes No*
Scene	Scene	Yes No*
Timer	Timer	Yes No*
Timer/toggle switch changeover	Timer/toggle switch changeover	Yes No*
Time limited toggle switch	Time limited toggle switch object	Yes No*
Preset 1	Preset 1	Yes No*
Preset 2	Preset 2	Yes No*

Note: The parameters and objects are identical for Lock-up 2 ; Only the terms will be adjusted.

Parameter	Description	Value
Status after lock-up function 1	<p>If the Lock-up type is set to Output lock-up, on cancellation of the lock-up the output will:</p> <p>Not changed.</p> <p>Is switched to the opposite status.</p> <p>Selectively switched on.</p> <p>Selectively switched off.</p> <p>Return to the status that was active before the lock-up.</p>	<p>Maintain status*</p> <p>Inversion</p> <p>ON</p> <p>OFF</p> <p>Status before lock-up 1</p>

Note: The application of this parameter depends on the priority of the other active functions. If a function with higher priority is active, this parameter will not be enacted. In the case where two functions with the same priority are active, the parameter of the most recently switched off function is enacted.

Note: The parameters and objects are identical for Lock-up 2 ; Only the terms will be adjusted.

Parameter	Description	Value
Activation of lock-up status object	<p>The Status indication lock-up communication object is hidden.</p> <p>The Status indication lock-up communication object is displayed.</p>	<p>Not active*</p> <p>Active</p>

Communication objects: [13 - Output 1 - Status indication lock-up \(1 bit - 1.011 DPT_State\)](#)

Parameter	Description	Value
Polarity	<p>The Status indication Lock-up communication object sends:</p> <p>0 on deactivation of the lock-up. 1 on activation of the lock-up.</p> <p>0 on activation of the lock-up. 1 on deactivation of the lock-up.</p>	<p>0 = Lock-up deactivated, 1 = Lock-up activated*</p> <p>0 = Lock-up activated, 1 = Lock-up deactivated</p>

* Default value

Parameter	Description	Value
Emission	The Status indication lock-up communication object is sent: On activation and deactivation of the lock-up. Periodically after a configurable time. On activation and deactivation of the lock-up and periodically after a configurable time.	On status change* Periodically On status change and periodically

Note: This parameter is only visible if the **Activation of Lock-up status object** parameter has the following value: **Active**.

Parameter	Description	Value
Hours (h)	This parameter determines the time between the individual transmissions of the Status indication lock-up object.	0 hours: 0 to 23 h
Minutes (min)		10 minutes: 0 to 59 min
Seconds (s)		0 seconds: 0 to 59 s

Note: The smallest executable time is 1 second.

Note: This parameter is only visible if the **Emission** parameter has the following value: **Periodically** or **On status change and periodically**.

3.5.7 Priority

Output 1: General	Activation of priority status object	<input checked="" type="checkbox"/>
- O1: Status indications	Polarity	<input checked="" type="radio"/> 0 = Not forced, 1 = Forced <input type="radio"/> 0 = Forced, 1 = Not forced
- O1: Device diagnosis	Emission	On status change and periodically
Output 1: Function selection	Hours	0 h
	Minutes	10 min
- O1: Priority	Seconds	0 s
Information	Status after priority	Maintain status

The Priority is used to force the output into a predefined state.

Priority: **Priority** > Lock-up > Basic function.

No other command is taken into account when the Priority is active. Only by ending the Priority are other commands again permitted.

Parameter	Description	Value
Activation of priority status object	The Status indication priority communication object and related parameters are hidden. The Status indication priority communication object and related parameters are displayed.	Not active* Active

Communication objects: [15 - Output 1 - Status indication priority \(1 bit - 1.011 DPT_State\)](#)

* Default value

Parameter	Description	Value
Polarity	The Status indication priority communication object sends: 0 on deactivation of the Priority. 1 on activation of the Priority. 0 on activation of the Priority. 1 on deactivation of the Priority.	0 = Not forced, 1 = Forced* 0 = Forced, 1 = Not forced

Note: This parameter is only visible if the **Activation of priority status object** parameter has the following value: **Active**.

Parameter	Description	Value
Emission	The Status indication priority communication object is sent: On activation and deactivation of the Priority. Periodically after a configurable time. On activation and deactivation of the Priority and periodically after a configurable time.	On status change* Periodically On status change and periodically

Note: This parameter is only visible if the **Activation of priority status object** parameter has the following value: **Active**.

Parameter	Description	Value
Hours (h)	This parameter determines the time between the individual transmissions of the Status indication priority object.	0 hours: 0 to 23 h
Minutes (min)		10 minutes: 0 to 59 min
Seconds (s)		0 seconds: 0 to 59 s

Note: The smallest executable time is 1 second.

Note: This parameter is only visible if the **Emission** parameter has the following value: **Periodically** or **On status change and periodically**.

Parameter	Description	Value
Status after priority	At the end of the priority, the output is: Not changed. Is switched to the opposite status. Selectively switched on. Selectively switched off. Switched back to the status before priority was activated. Switched to the status which would be active according to other communication objects if the priority had not taken place.	Maintain status* Inversion ON OFF Status before priority Theoretical status without priority

Note: The application of this parameter depends on the priority of the other active functions. If a function with higher priority is active, this parameter will not be enacted. In the case where two functions with the same priority are active, the parameter of the most recently switched off function is enacted.

* Default value

3.5.8 Hours counter

The Hours Counter function is used to count the overall operating time of an output in the ON or OFF state. The operating hours counter setpoint can be programmed and altered via an object.

Output 1: General	Relay status for operating hours counter	<input type="radio"/> Opened <input checked="" type="radio"/> Closed
- O1: Status indications	Hours counter direction	<input checked="" type="radio"/> Increment <input type="radio"/> Countdown
- O1: Device diagnosis	Hours counter setpoint	10000
Output 1: Function selection	Counter setpoint value modifiable through object	<input type="checkbox"/>
- O1: Hours counter		
Information	Emission hours counter value	On status change and periodically
	Value interval	100 h
	Periodical emission delay	1 h
	Periodical emission delay	0 min
	Periodical emission delay	0 s
	Object emission counter setpoint reached	Periodically
	Periodical emission delay	1 h
	Periodical emission delay	0 min
	Periodical emission delay	0 s

Parameter	Description	Value
Relay status for operating hours counter	The hours counter runs if: The output is closed. The output is open.	Closed* Opened

Parameter	Description	Value
Hours counter direction	The hours counter counts: Growing. Decreasing.	Increment* Countdown

* Default value

Increment:

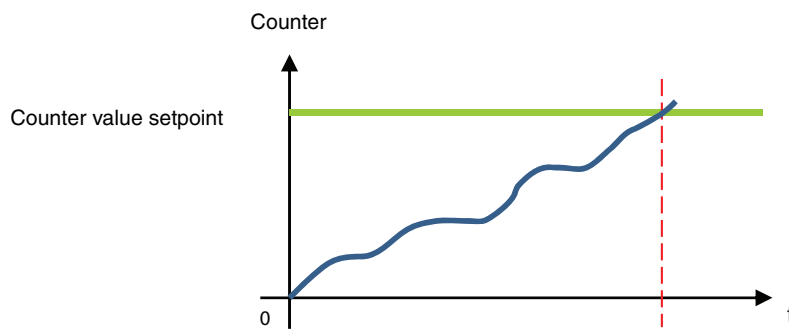

The counter starts to count up from the value 0. As soon as the counter setpoint (**Hours counter setpoint** object) is reached, the **Hours counter setpoint reached** object is set to 1 and sent to the bus.

Countdown:

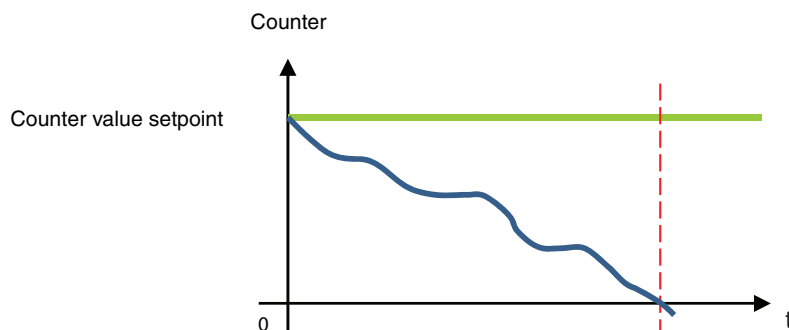

The counter starts to count down from the operating hours counter setpoint (**Hours counter setpoint** object). As soon as the counter reaches 0, the **Hours counter setpoint reached** is set to 1 and sent to the bus.

Parameter	Description	Value
Hours counter setpoint	This parameter determines the value of the hours counter.	1 ... 10000* ... 65535

An incrementing counter starts at 0 and counts up until it reaches the setpoint value.
A countdown counter starts to count at the setpoint value and counts down until it has arrived at 0.

Parameter	Description	Value
Counter setpoint value modifiable through object	The Hours counter setpoint communication object is hidden. The Hours counter setpoint communication object is displayed. The value can be changed via the KNX bus.	Not active* Active

Communication objects: [19 - Output 1 - Hours counter setpoint \(2 byte - 7.001 DPT_16_bit_Counter\)](#)

* Default value

Parameter	Description	Value
Emission hours counter value	The Hours counter value communication object is sent: On each change. Periodically after a configurable time. On change and periodically after a configurable time.	On status change* Periodically On status change and periodically

Parameter	Description	Value
Value interval (h)	This parameter specifies the value interval (in hours) for the sending frequency of the Hours counter setpoint object.	1 ... 100* ... 65535 (hours)

*Note: If the value interval is 200 hours, then the **Hours counter setpoint** object is sent each time the Operating h. counter value is increased by 200 hours.*

*Note: This parameter is only visible if the **Emission hours counter value** parameter has the following value: **Periodically** or **On status change and periodically**.*

Parameter	Description	Value
Periodical emission delay	This parameter determines the time between the individual transmissions of the Hours counter setpoint object.	1 hours: 0 to 23 h 0 minutes: 0 to 59 min 0 seconds: 0 to 59 s

Note: The smallest executable time is 1 second.

*Note: This parameter is only visible if the **Emission hours counter value** parameter has the following value: **Periodically** or **On status change and periodically**.*

Parameter	Description	Value
Emission object counter setpoint reached	The Hours counter setpoint reached communication object is sent: On reaching the counter setpoint. Periodically after a configurable time. On reaching the counter setpoint and periodically after a configurable time.	On status change Periodically* On status change and periodically

Parameter	Description	Value
Periodical emission delay	This parameter determines the time between the individual transmissions of the Hours counter setpoint reached object.	1 hours: 0 to 23 h 0 minutes: 0 to 59 min 0 seconds: 0 to 59 s

Note: The smallest executable time is 1 second.

*Note: This parameter is only visible if the Object **Emission counter setpoint reached** parameter has the following value: **Periodically** or **On status change and periodically**.*

* Default value

4. Communication objects

4.1 Communication objects General

	Number	Name	Function of the object	Length	C	R	W	T
	22	Logic block 1	Authorization	1 bit	C	R	W	-
	23	Logic block 1	Input 1	1 bit	C	R	W	-
	24	Logic block 1	Input 2	1 bit	C	R	W	-
	25	Logic block 1	Input 3	1 bit	C	R	W	-
	26	Logic block 1	Input 4	1 bit	C	R	W	-
	27	Logic block 1	Logic result	1 bit	C	R	-	T
	28	Logic block 2	Authorization	1 bit	C	R	W	-
	29	Logic block 2	Input 1	1 bit	C	R	W	-
	30	Logic block 2	Input 2	1 bit	C	R	W	-
	31	Logic block 2	Input 3	1 bit	C	R	W	-
	32	Logic block 2	Input 4	1 bit	C	R	W	-
	33	Logic block 2	Logic result	1 bit	C	R	-	T
	34	Outputs 1-2	Restore ETS-params settings	1 bit	C	R	W	-
	36	Outputs 1-2	Diagnosis	6 byte	C	R	-	T

4.1.1 Logic block

No.	Name	Function of the object	Data type	Flags
22	Logic block 1	Authorization	1 bit - 1.003 DPT_Enable	C, R, W
<p>This object is activated if the Logic block 1 parameter and the Lock-up logic block object are active. This object makes it possible to activate or deactivate the logic blocks of the device via the KNX bus. Object value: Depends on the Polarity parameter.</p> <p>0 = Locked-up, 1 = Authorized:</p> <ul style="list-style-type: none"> - If the object receives the value 0, logic block 1 is deactivated. - If the object receives the value 1, logic block 1 is activated. <p>0 = Authorized, 1 = Locked-up:</p> <ul style="list-style-type: none"> - If the object receives the value 0, logic block 1 is activated. - If the object receives the value 1, logic block 1 is deactivated. <p>The value of this object can be initialized at start-up of the device.</p> <p>For further information, see: Logic block.</p>				

No.	Name	Function of the object	Data type	Flags
23	Logic block 1	Input 1	1 bit - 1.002 DPT_Bool	C, R, W
24	Logic block 1	Input 2	1 bit - 1.002 DPT_Bool	C, R, W
25	Logic block 1	Input 3	1 bit - 1.002 DPT_Bool	C, R, W
26	Logic block 1	Input 4	1 bit - 1.002 DPT_Bool	C, R, W

These objects are activated in accordance with the value of the **Number of logic inputs** parameter. There may be up to a maximum of 4 of these objects.

These objects are used to produce the status of a logic input for processing of the logic operation.

The value of these objects can be initialized at start-up of the device.

For further information, see: [Logic block](#).

No.	Name	Function of the object	Data type	Flags
27	Logic block 1	Logic result	1 bit - 1.002 DPT_Bool	C, R, T

This object is activated when the **Logic block 1** parameter is active.

This object enables output of the results of the logic operation via the bus.

The value of the object is the result of a logic AND or OR operation, according to the status of the logic inputs. There may be up to a maximum of 4 of these objects. This result can also be directly assigned to the status of the output contact.

For further information, see: [Logic block](#).

No.	Name	Function of the object	Data type	Flags
28	Logic block 2	Authorization	1 bit - 1.003 DPT_Enable	C, R, W

See object No. 194

No.	Name	Function of the object	Data type	Flags
29	Logic block 2	Input 1	1 bit - 1.002 DPT_Bool	C, R, W
30	Logic block 2	Input 2	1 bit - 1.002 DPT_Bool	C, R, W
31	Logic block 2	Input 3	1 bit - 1.002 DPT_Bool	C, R, W
32	Logic block 2	Input 4	1 bit - 1.002 DPT_Bool	C, R, W

See object No. 195

No.	Name	Function of the object	Data type	Flags
33	Logic block 2	Logic result	1 bit - 1.002 DPT_Bool	C, R, T

See object No. 199

4.1.2 Behaviour of the device

No.	Name	Function of the object	Data type	Flags
34	Output 1	Restore ETS-params settings	1 bit - 1.015 DPT_Reset	C, R, W

This object is activated if the **Activ. of restore ETS-parameters object (scenes, timer, setpoints)** parameter is active.

This object enables the current parameter value to be replaced at any time with the ETS parameter value.

If the object receives value 1, then the output status values for the scenes, the timer duration specifications and all the counter setpoints are reset to the values sent by the last download.

For further information, see: [Restore ETS-Parameters](#).

4.1.3 Diagnosis

No.	Name	Function of the object	Data type	Flags
36	Output 1	Diagnosis	6 byte - Specific	C, R, T

This object is activated when the **Device diagnosis object** parameter is active.
 The object enables reporting of current faults according to the device and the application used. It also allows sending of the position of the switch on the front of the device and the number of the output that is affected by the fault(s).

Byte number	6 (MSB)	5	4	3	2	1(LSB)
Use	Switch position	Application type	Output number	Error codes		

This object is sent periodically and/or on status change.

For further information, see: [Diagnosis](#).

4.2 Output communication objects

	Number	Name	Function of the object	Length	C	R	W	T
	0	Output 1	ON/OFF	1 bit	C	R	W	-
	1	Output 1	Timer/toggle switch changeover	1 bit	C	R	W	-
	2	Output 1	Time limited toggle switch object	1 bit	C	R	W	-
	3	Output 1	Status indication ON/OFF	1 bit	C	R	-	T
	4	Output 1	Timer	1 bit	C	R	W	-
	5	Output 1	Timer duration	3 byte	C	R	W	-
	6	Output 1	Scene	1 byte	C	R	W	-
	7	Output 1	Preset 1	1 bit	C	R	W	-
	8	Output 1	Preset 2	1 bit	C	R	W	-
	9	Output 1	Preset 1 authorization	1 bit	C	R	W	-
	10	Output 1	Preset 2 authorization	1 bit	C	R	W	-
	11	Output 1	Lock-up 1	1 bit	C	R	W	-
	12	Output 1	Lock-up 2	1 bit	C	R	W	-
	13	Output 1	Status indication lock-up	1 bit	C	R	-	T
	14	Output 1	Priority	2 bit	C	R	W	-
	15	Output 1	Status indication priority	1 bit	C	R	-	T
	16	Output 1	Hours counter value	2 byte	C	R	-	T
	17	Output 1	Reset hours counter value	1 bit	C	R	W	-
	18	Output 1	Hours counter setpoint reached	1 bit	C	R	-	T
	19	Output 1	Hours counter setpoint	2 byte	C	R	W	-

4.2.1 ON/OFF

No.	Name	Function of the object	Data type	Flags
0	Output 1	ON/OFF	1 bit - 1.001 DPT_Switch	C, R, W

These objects are always activated. They enable switching of the output contact in accordance with the value that is sent via the KNX bus.

Object value: Object value: depends on the **Output contact** parameter.

Normally open:

- On input of an OFF command, the output relay contact opens.
- On input of an ON command, the output relay contact closes.

Normally closed:

- On input of an OFF command, the output relay contact closes.
- On input of an ON command, the output relay contact opens.

For further information, see: [Definition](#).

4.2.2 ON/OFF timings function

No.	Name	Function of the object	Data type	Flags
1	Output 1	Timer/toggle switch changeover	1 bit - 1.001 DPT_Switch	C, R, W

This object is activated if the **Timer/toggle switch changeover for ON/OFF** object parameter is active.

This object is used to switch between a toggle switch and timer switch operation on the same pushbutton.

- If the **Timer/toggle switch changeover** object receives the value 1, the Toggle-switch mode function is activated. The ON/OFF switching of the output is performed as usual via the **ON/OFF** object.
- If the **Timer/toggle switch changeover** object receives the value 0, the Timer mode function is activated.
 - If the **ON/OFF** object receives the value 1, the output is switched ON. After expiry of a configurable time, the output is automatically switched OFF.
 - If the **ON/OFF** object receives the value 0, the output is switched OFF.

Example: Switching function daytime and Time-limited OFF function at night.
During the day, the button is used as a switch. In the evenings, the button is used as a time-limited OFF switch, so that the light will turn off automatically.

For further information, see: [ON/OFF timings function](#).

No.	Name	Function of the object	Data type	Flags
2	Output 1	Time limited toggle switch object	1 bit - 1.001 DPT_Switch	C, R, W

This object is activated when the **Additional time limited toggle switch function** parameter is active.

This object combines a timer function with a tripping Delay function.

- If the object receives the value 1, the output switches to ON for a configurable time period. After that period expires, the output switches to OFF.
- If the object receives the value 0, the output switches to OFF.

Note: The time-limited OFF function is generally used for lighting in cellars, attics and sheds.

For further information, see: [ON/OFF timings function](#).

4.2.3 Status indication

No.	Name	Function of the object	Data type	Flags
3	Output 1	Status indication ON/OFF	1 bit - 1.001 DPT_Switch	C, R, T

This object is activated when the **Status indication ON/OFF** parameter is active.
 This object allows the status of the output contact to be sent from the device over the KNX bus.
 Object value: Depends on the **Polarity** parameter.

0 = ON, 1 = OFF

- If the output relay is open, a telegram with logic value 1 is sent on the KNX bus.
- If the output relay is closed, a telegram with logic value 0 is sent on the KNX bus.

0 = OFF, 1 = ON

- If the output relay is open, a telegram with logic value 0 is sent on the KNX bus.
- If the output relay is closed, a telegram with logic value 1 is sent on the KNX bus.

This object is sent periodically and/or on status change.

For further information, see: [Status indication](#).

4.2.4 Timer

No.	Name	Function of the object	Data type	Flags
4	Output 1	Timer	1 bit - 1.001 DPT_Switch	C, R, W

This object is activated when the **Timer** parameter is active.
 This object is used to activate the Timer function of the device via the KNX bus.
 Object value:

- If a rising edge (0 to 1) arrives at this object, the output switches for a configurable period.
- If a falling edge (1 to 0) arrives at this object, the output remains in its current state.

Note: Depending on the configuration, the timer switching can be interrupted on the timer by a long press of the control button.
Note: Depending on the configuration, the timer duration may be reset by input of a start command during timer operation.

For further information, see: [Timer](#).

No.	Name	Function of the object	Data type	Flags
5	Output 1	Timer duration	3 byte - 10.001 DPT_TimeOfDay	C, R, W

This object is activated if the **Timer duration modifiable through object** object parameter is active.
 This object can be used to configure the timer duration. The timer duration can thus be configured in accordance with a time of day.

Byte 3 (MSB)					Byte 2						Byte 1 (LSB)												
Hours					Minutes						Seconds												
0	0	0	H	H	H	H	H	0	0	M	M	M	M	M	M	0	0	S	S	S	S	S	S

Fields	Code	Value	Units
Hours	Binary	0 to 23 (5 bit)	Hours
Minutes	Binary	0 to 59 (6 bit)	Minutes
Seconds	Binary	0 to 59 (6 bit)	Seconds

For further information, see: [Timer](#).

4.2.5 Scene

No.	Name	Function of the object	Data type	Flags
6	Output 1	Scene	1 byte - 17.001 DPT_SceneNumber	C, R, W

This object is activated when the **Scene** parameter is active.

This object is used to recall or save a scene.

Details on the format of the object are given below.

7	6	5	4	3	2	1	0
Learning	Not used	Scene number					

Bit 7: 0: The scene is called / 1: The scene is saved.

Bit 6: Not used.

Bit 5 to Bit 0: Scene numbers from 0 (Scene 1) to 63 (Scene 64).

For further information, see: [Scene](#).

4.2.6 Preset

No.	Name	Function of the object	Data type	Flags
7	Output 1	Preset 1	1 bit - 1.022 DPT_Scene_AB	C, R, W

This object is activated if the **Preset** has value **Active with preset 1-level object** or **Active with preset 2-level objects**.

With this object, several outputs can be set to a configurable predefined status.

Object value:

- If the object receives value 0, the values of the parameters for Preset 1 = 0 are used.
- If the object receives value 1, the values of the parameters for Preset 1 = 1 are used.

For further information, see: [Preset](#).

No.	Name	Function of the object	Data type	Flags
8	Output 1	Preset 2	1 bit - 1.022 DPT_Scene_AB	C, R, W

This object is activated if the **Preset** parameter has value **Active with preset 2-level objects**.

See object No. 7

No.	Name	Function of the object	Data type	Flags
9	Output 1	Preset 1 authorization	1 bit - 1.003 DPT_Enable	C, R, W

This object is activated if the **Preset authorization objects** parameter is active.

This object allows the authorization or lock-up of the Preset 1 function via a KNX telegram.

Object value: This is dependent on the **Polarity of autorisation object Preset 1** parameter.

0 = Locked-up, 1 = Authorized:

- If the object receives the value 0, Preset 1 is deactivated.
- If the object receives the value 1, Preset 1 is activated.

0 = Authorized, 1 = Locked-up:

- If the object receives the value 0, Preset 1 is activated.
- If the object receives the value 1, Preset 1 is deactivated.

For further information, see: [Preset](#).

No.	Name	Function of the object	Data type	Flags
10	Output 1	Preset 2 authorization	1 bit - 1.003 DPT_Enable	C, R, W
See object No. 9				

4.2.7 Lock-up

No.	Name	Function of the object	Data type	Flags
11	Output 1	Lock-up 1	1 bit - 1.003 DPT_Enable	C, R, W
<p>This object is activated if the Lock-up has value Active with 1 lock-up object or Active with 2 lock-up objects. This object is used to control the activation of the lock-up via the KNX bus. Object value: This is dependent on the Polarity of lock-up object 1 parameter. 0 = Lock-up activated, 1 = Lock-up deactivated:</p> <ul style="list-style-type: none"> - If the object receives value 0, the Lock-up is activated. - If the object receives value 1, the Lock-up is deactivated. <p>0 = Lock-up deactivated, 1 = Lock-up activated:</p> <ul style="list-style-type: none"> - If the object receives value 0, the Lock-up is deactivated. - If the object receives value 1, the Lock-up is activated. <p>For further information, see: Lock-up.</p>				

No.	Name	Function of the object	Data type	Flags
12	Output 1	Lock-up 2	1 bit - 1.003 DPT_Enable	C, R, W
<p>This object is activated if the Lock-up parameter has value Active with 2 lock-up objects.</p> <p>See object No. 11.</p>				

No.	Name	Function of the object	Data type	Flags
13	Output 1	Status indication lock-up	1 bit - 1.011 DPT_Enable	C, R, T
<p>This object is activated when the Activation of lock-up status object parameter is active. This object allows the status of the lock-up to be sent from the device over the KNX bus. Object value: Depends on the Polarity parameter. 0 = Lock-up deactivated, 1 = Lock-up activated:</p> <ul style="list-style-type: none"> - If the lock-up is deactivated, a telegram with logic value 0 is sent on the KNX bus. - If the lock-up is activated, a telegram with logic value 1 is sent on the KNX bus. <p>0 = Lock-up activated, 1 = Lock-up deactivated:</p> <ul style="list-style-type: none"> - If the lock-up is activated, a telegram with logic value 0 is sent on the KNX bus. - If the lock-up is deactivated, a telegram with logic value 1 is sent on the KNX bus. <p>This object is sent periodically and/or on status change. For further information, see: Lock-up.</p>				

4.2.8 Priority

No.	Name	Function of the object	Data type	Flags
14	Output 1	Priority	2 bit - 2.002 DPT_Bool_Control	C, R, W

This object is activated if the **Priority** parameter is active.
 The status of the output contact is determined directly by this object.
 Details on the format of the object are given below.

Telegram received by the priority operation object			Output behaviour
Hexadecimal Value	Binary Value		
	Bit 1 (MSB)	Bit 0 (LSB)	
00	0	0	End of the priority
01	0	1	End of the priority
02	1	0	Priority OFF
03	1	1	Priority ON

The first bit of this object (Bit 0) determines the status of the output contact, which should be priority controlled. The second bit activates or deactivates the Priority.

For further information, see: [Priority](#).

No.	Name	Function of the object	Data type	Flags
15	Output 1	Status indication priority	1 bit - 1.011 DPT_State	C, R, T

This object is activated if the **Activation of priority status object** parameter is active.
 This object allows the status of the Priority to be sent from the device on the KNX bus.
 Object value: Depends on the **Polarity** parameter.

0 = Not forced, 1 = Forced:

- If Priority is deactivated, a telegram is sent with logic value 0.
- If Priority is activated, a telegram is sent with logic value 1.

0 = Forced, 1 = Not forced:

- If Priority is activated, a telegram is sent with logic value 0.
- If Priority is deactivated, a telegram is sent with logic value 1.

This object is sent periodically and/or on status change.

For further information, see: [Priority](#).

4.2.9 Hours counter

No.	Name	Function of the object	Data type	Flags
16	Output 1	Hours counter value	2 byte - 7.001 DPT_16_bit_Counter	C, R, T

This object is activated when the **Hours counter** parameter is active.
 This object allows the value of the operating hours to be sent from the device on the KNX bus.
 The count value is saved during a power cut on the KNX bus. It is submitted after return of power to the bus or after an ETS download.
 Object value: 0 to 65535 hours.

This object is sent periodically and/or on status change.

For further information, see: [Hours counter](#).

No.	Name	Function of the object	Data type	Flags
17	Output 1	Reset hours counter value	1 bit - 1.015 DPT_Reset	C, R, W
<p>This object is activated when the Hours counter parameter is active. This object enables the hours counter value to be reset. Object value:</p> <ul style="list-style-type: none"> - If the object receives the value 0, the counter is not reset. - If the object receives the value 1, the counter is reset. <p>For further information, see: Hours counter.</p>				

No.	Name	Function of the object	Data type	Flags
18	Output 1	Hours counter setpoint reached	1 bit - 1.002 DPT_Bool	C, R, T
<p>This object is activated when the Hours counter parameter is active. This object reports that the hours counter has reached its setpoint.</p> <ul style="list-style-type: none"> - Incrementing counter: Counter = Counter value setpoint. - Countdown counter: Counter = 0. <p>Object value: If the setpoint is reached, a telegram with logic value 1 is sent on the KNX bus. The count value is saved during a power cut on the KNX bus. It is submitted after return of power to the bus or after an ETS download.</p> <p>This object is sent periodically and/or on status change. For further information, see: Hours counter.</p>				

No.	Name	Function of the object	Data type	Flags
19	Output 1	Counter value setpoint	2 byte - 7.001 DPT_16_bit_Counter	C, R, W
<p>This object is activated if the Counter setpoint value modifiable through object object parameter is active. This object is used to initialize the counter setpoint of the hours counter via the KNX bus. Object value: 0 to 65535 hours.</p> <p>This object is sent periodically and/or on status change. For further information, see: Hours counter.</p>				

5. Appendix

5.1 Specifications

TYB601B

Supply voltage KNX	21...32 V DC TBTS
Breaking capacity	μ 10 A AC1 230 V~
Switching current at $\cos \Phi = 0.8$ max.	10 A
Minimum switching current	10 mA
Operating altitude max.	2000 m
Degree of contamination	2
Surge voltage	4 kV
Degree of protection of housing	IP20
Impact protection	IK 04
Overvoltage class	III
Ambient temperature	-5 °C ... +45 °C
Storage/transport temperature	-20 °C ... +70 °C
Maximum switching cycle rate at full load	
switching cycle/minute	20
Connection capacity	0,75 mm ² ... 2,5 mm ²
Standards	EN 50491-3 ; EN 60669-2-1
Dimensions	44 x 43 x 22,5 mm
Own consumption on the KNX bus:	
typical	7 mA
in standby	5 mA
Incandescent lamps	600 W
Halogen lamps	600 W
Conventional transformer	600 VA
Electronic transformer	600 W
Fluorescent lamps	
--without ballast	600 W
--with EVG	6 x 58 W
Energy-saving lamps	5 x 15 W
LED lamps	5 x 15 W

5.2 Table of logical operations

Input 4	Input 3	Input 2	Input 1	OR	AND
-	-	0	0	0	0
-	-	0	1	1	0
-	-	1	0	1	0
-	-	1	1	1	1
-	0	0	0	0	0
-	0	0	1	1	0
-	0	1	0	1	0
-	0	1	1	1	0
-	1	0	0	1	0
-	1	0	1	1	0
-	1	1	0	1	0
-	1	1	1	1	1
0	0	0	0	0	0
0	0	0	1	1	0
0	0	1	0	1	0
0	0	1	1	1	0
0	1	0	0	1	0
0	1	0	1	1	0
0	1	1	0	1	0
0	1	1	1	1	0
1	0	0	0	1	0
1	0	0	1	1	0
1	0	1	0	1	0
1	0	1	1	1	0
1	1	0	0	1	0
1	1	0	1	1	0
1	1	1	0	1	0
1	1	1	1	1	1

5.3 Characteristics

Device	TYB601B
Max. number of group addresses	254
Max. number of allocations	255
Objects	34

