









- ▲  Manufacturers
- ▲  Hager Electro
- ▲  Output
-  4-channel analog actuator

Application software

4 Output analog- 4 Output analog extension
Electrical / Mechanical characteristics : see product information

	Order number	Product designation	Application software ref.	TP device  RF devices 
	TYF684	4 Output analog	STYF684	
	TYF684E	4 Output analog extension	STYF684	

Summary

1. SCOPE OF APPLICATION	3
2. TECHNICAL DATA	4
3. CONNECTION AND TERMINALS	6
4. APPLIKATION	9
5. BASIC FUNCTION	11
6. USE OF 16-BIT VALUES	12
7. USE OF 8-BIT VALUES	13
7.1 DIMMING ACTUATOR FUNCTION.....	13
8. FORCED GUIDANCE	13
9. CYCLICAL MONITORING	13
10. CONNECTION WITH AN ANALOG ACTUATOR MODULE 4GANG	15
10.1 SETTINGS OF THE ANALOG OUTPUT MODULE / ANALOG ACTUATOR MODULE.....	15
10.2 ELECTRICAL CONNECTION	15
11. COMMISSIONING AND INITIALIZATION	15
12. STATUS INDICATION	15
13. PARAMETERS	16

1. Scope of application

The analog actuator 4gang converts measuring data received via KNX telegrams (DPT-ID 9.0xx and 5.010) into analog output signals. The analog output signals enable heating, ventilation and air conditioning units to adapt their output values to information received from the bus and thus to take part in control processes.

current signals:	0...20 mA DC	4...20 mA DC
voltage signals :	0...1 V DC	0...10 V DC

The analog actuator 4gang has four analog outputs which can be software-parameterized for one of the ranges mentioned above. Outputs not used can be deactivated.

The output variables can be force-controlled from a coordinating control system.

With an analog actuator module, the number of analog outputs can be increased from 4 to 8.

In conjunction with the "dimming" function of the push button, both the analog actuator 4gang and also the analog actuator module 4gang can be used as an active control unit for dimming applications.

The analog actuator 4gang needs 24 V AC for operation. The necessary power can be supplied by the power supply unit Order. no. ST312. This power supply unit is capable of supplying power at the same to a connected analog actuator module 4gang.

Layout

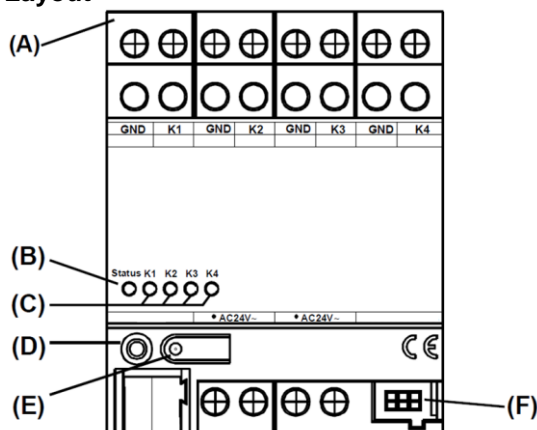

Dimensions:

Width: 4 mod., 72 mm
 Height: 90 mm
 Depth: 58 mm

Controls:

A: analog outputs 1 ... 4
 B: status LED of device, three-coloured (red, orange, green)
 C: status LEDs of the four outputs mono, yellow
 D: programming LED
 E: programming button
 F: system connector, 6-pole, for extension module

Status LED (B) indication for analog actuator:

LED off	no power supply
LED orange/on	module scan by analog actuator
LED orange/flashing fast	module scan REG extension module
LED red/flashing slowly	fault: voltage too low at module connection / Us short-circuit
LED red/flashing fast	fault: no project, parameter error
LED green/flashing slowly	module scan terminated, projecting OK
LED green/flashing fast	parameter download to modules
LED green/on	initialization terminated, everything OK

slow flashing rate:
 approx. 1 Hz
 fast flashing rate:
 approx. 2 Hz

Status LED (C) indication for the 4 analog outputs:

LED off	output signal is zero
LED on	output signal is greater than zero

2. Technical data

Type of protection:	IP 20
Mark of approval:	KNX
Ambient temperature:	-5 °C ... +45 °C
Storage / transport temperature:	-25 °C ... +70 °C, storage above 45°C reduces the service life
Max. housing temperature	T _c = 75 °C
Relative humidity:	Max. 93% r. h., no condensation
Mounting position:	any
Minimum distances:	none
Type of fastening:	snap-fastening on DIN rail 35 x 7.5 mm

KNX supply	
voltage:	21 ... 32 V DC
power consumption:	typical 150 mW
connection:	bus connecting terminal KNX type 1.1
External supply	
voltage:	24 V AC +- 10 %
power consumption:	max. 310 mA
connection:	screw terminals 0.5mm ² to 4mm ² single wire screw terminals 0.34mm ² to 4mm ² stranded wire (without ferrule) screw terminals 0.14mm ² to 2.5mm ² stranded wire (with ferrule)
Response to mains failures	
bus voltage only:	parameterizable: last value maintained; fixed value (in %)
mains voltage only:	outputs down to 0 V or to 0 mA
bus and mains voltage:	outputs down to 0 V or to 0 mA
Response on return of voltage	
bus voltage only:	parameterizable: no reaction; state of initialization; last value before failure
mains voltage only:	parameterizable status request of group addresses, determination and setting of the parameterizable output states with bus voltage applied
bus and mains voltage:	parameterizable status inquiry of group addresses, determination and setting of the parameterizable output states with bus voltage applied
Connection of modules	
number:	1
connection:	6-pole system connector for extension module
Analog outputs	
number:	4
type of signal:	0...1V DC, 0...10V DC, 0...20mA DC or 4...20mA DC, depending on parameterization
output signal load	voltage signal: ≥ 1kΩ current signal: ≤ 500 Ω
output current	voltage signal: max. 10 mA per channel current signal: max. 20 mA per channel
connection:	screw terminals 0.5mm ² to 4mm ² single wire screw terminals 0.34mm ² to 4mm ² stranded wire (without ferrule) screw terminals 0.14mm ² to 2.5mm ² stranded wire (with ferrule)

3. Connection and terminals

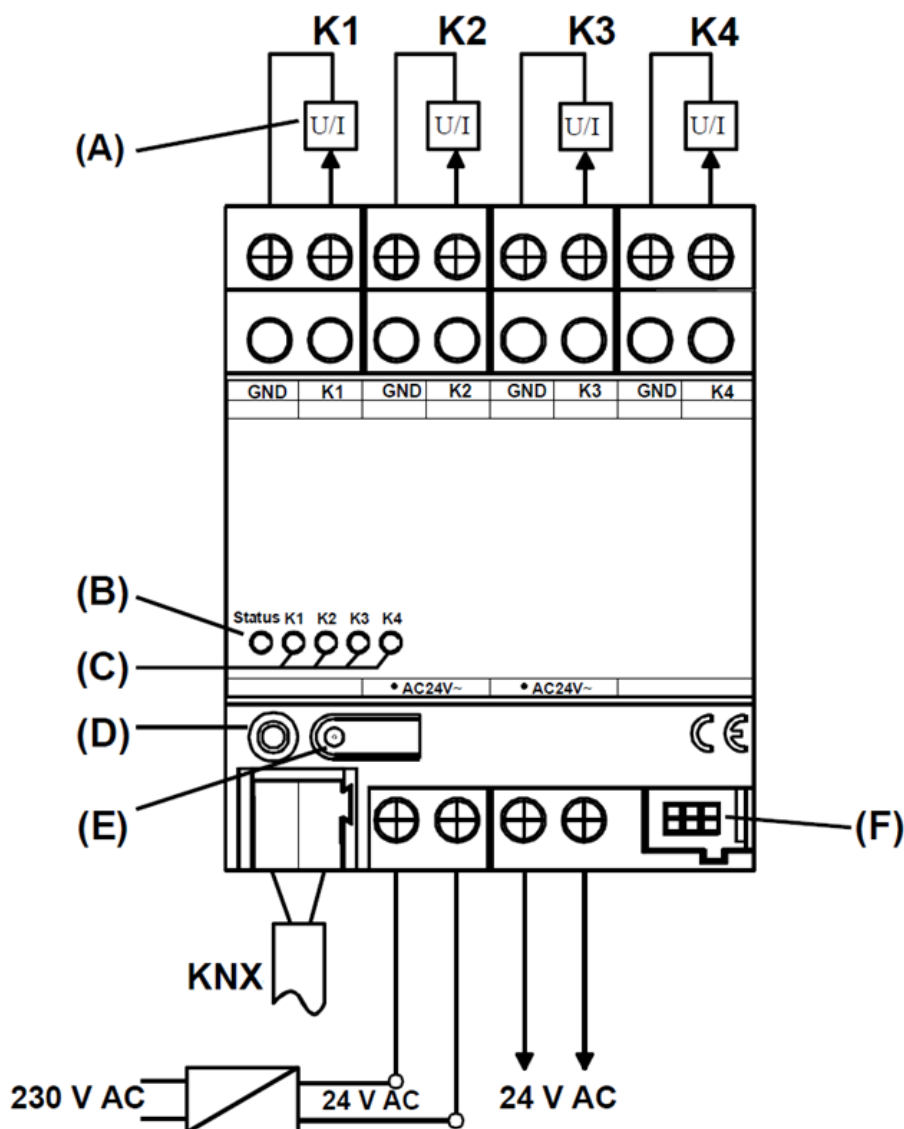

Connection:

GND:	reference potential for outputs 1 ... 4	A:	analog outputs 1 ... 4
K1..K4	outputs 1 ... 4	B:	status LED of device, three-coloured (red, orange, green)
		C:	status LED of the four outputs, monochrome, yellow
		D:	programming LED
		E:	programming key
		F:	system connector, 6-pole, for extension module
KNX:	KNX connecting terminal		
24V AC:	external supply voltage		
6-pole connector:	connection of extension module		

Connection and terminals with extension

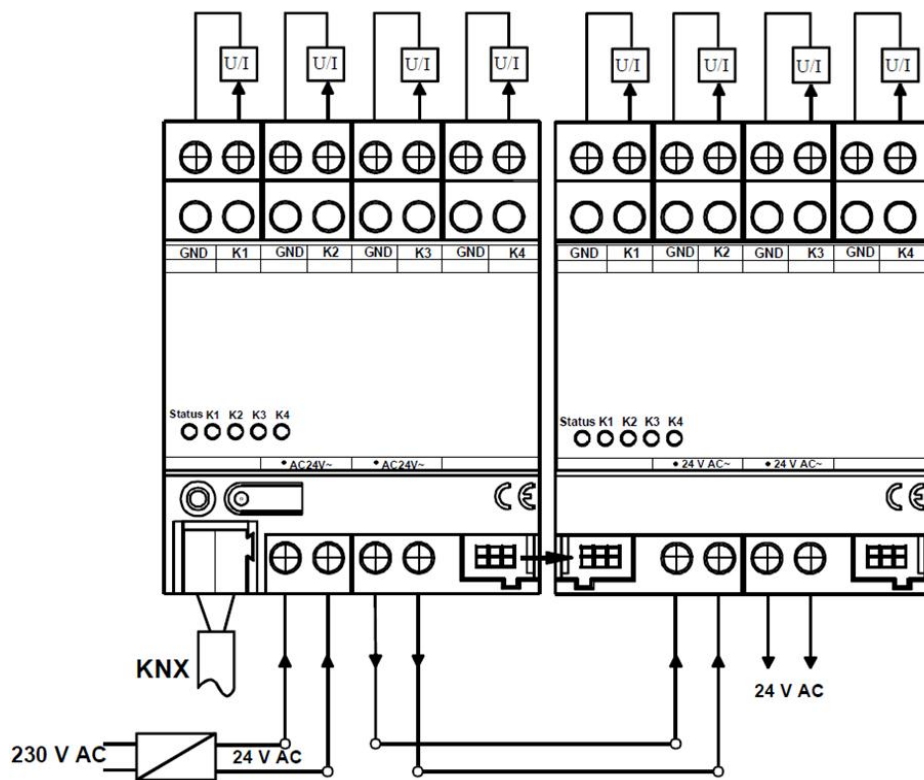

Hardware remarks

- The GND terminals must not be connected to the corresponding terminals of another device.
- The outputs of the analog actuator 4gang and of the analog actuator module 4gang must not be connected to the 1 ... 10 V interface of electronic ballasts or electronic transformers.
- All connected components must ensure safe separation from other voltages.

When installing the analog actuator module, the following basic rules must be observed:

- An analog actuator module 4gang is connected to the analog actuator 4gang only with the 6-pole system connector (supplied with the analog actuator module 4gang).
- One extension module only can be connected to the device.
- An analog actuator module 4gang can be replaced (e.g. in case of defect) while the system is in operation (disconnect the voltage supply from the module). After the replacement, the analog actuator 4gang makes a reset after appr. 25 s. This action re-initializes all outputs and resets them to their original state.
- Removal or addition of modules without adapting the project and subsequent downloading into the analog actuator 4gang is not permitted as this will result in system malfunctions.
- The GND terminals of the analog actuator module 4gang must not be connected to the corresponding terminals of another device, e.g. the analog actuator 4gang.
- After initial start-up, the analog actuator 4gang performs a module scan (status LED: "orange / on").
- Since a new device contains generally no project, the status LED switches thereafter to "red / flashing fast".

4. Applikation

Number of addresses (max): 200	dynamic table handling Yes <input checked="" type="checkbox"/> No <input type="checkbox"/>
Number of assignments (max): 200	maximum length of table 200

Communication objects 58

Object no.	Function	Name	DP type	Format	Flags
<input type="checkbox"/> ← 0 ... 3	Analog output	Input value output 1 ... 4	9.0xx	2 bytes	C, W, T
<input type="checkbox"/> ← 0 ... 3	Analog output	Input value output 1 ... 4	5.001	1 byte	C, W, T
<input type="checkbox"/> → 4 ... 7	Analog output	Status output 1 ... 4	9.0xx	2 bytes	C, R, T
<input type="checkbox"/> → 4 ... 7	Analog output	Status output 1 ... 4	5.001	1 byte	C, R, T
<input type="checkbox"/> ← 8 ... 15	Analog output	Forced guidance 1 / 2 output 1 ... 4	1.001	1 bit	C, W, T
<input type="checkbox"/> ← 16 ... 19	Analog output	Switching output 1 ... 4	1.001	1 bit	C, W, T
<input type="checkbox"/> ← 20 ... 23	Analog output	Dimming output 1 ... 4	3.007	4 bits	C, W, T
<input type="checkbox"/> → 24 ... 27	Analog output	Alarm output 1 ... 4	1.001	1 bit	C, R, T
<input type="checkbox"/> ← 29 ... 32	Extension module	Input value output 5 ... 8	9.0xx	2 bytes	C, W, T
<input type="checkbox"/> ← 29 ... 32	Extension module	Input value output 5 ... 8	5.001	1 byte	C, W, T
<input type="checkbox"/> → 33 ... 36	Extension module	Status output 5 ... 8	9.0xx	2 bytes	C, R, T
<input type="checkbox"/> → 33 ... 36	Extension module	Status output 5 ... 8	5.001	1 byte	C, R, T
<input type="checkbox"/> ← 37 ... 44	Extension module	Forced guidance 1 / 2 output 5 ... 8	1.001	1 bit	C, W, T
<input type="checkbox"/> ← 45 ... 48	Extension module	Switching output 5 ... 8	1.001	1 bit	C, W, T
<input type="checkbox"/> ← 49 ... 52	Extension module	Dimming output 5 ... 8	3.007	4 bits	C, W, T
<input type="checkbox"/> → 53 ... 56	Extension module	Alarm output 5 ... 8	1.001	1 bit	C, R, T
<input type="checkbox"/> → 57	Extension module	Alarm	1.001	1 bit	C, R, T

- 1) The type of the "Input value ..." and "Status ..." objects depends on the setting of the "Input format" parameter.
- 2) The "Switching" and "Dimming" objects of an output are visible only if the "Input format" parameter is set to "8 bits".
- 3) The "Forced guidance" objects of an output are visible only if the "Forced guidance object" parameter is set to "Forced guidance active with...".
- 4) Depending the setting of the "External limit-value object format", the objects 13 ... 20 can receive either 8-bit or 16-bit values.
- 5) Objects 29 ... 57 are visible only if the "Extension module present" parameter is set to "Yes".

Object description

□←	0 ... 3, 29 ... 32	Input value output x	1-byte or 2-byte objects which can be used for presetting the output. In the 1-byte mode, a new input value can be adopted by the direct or by the dimming approach. The input object can be monitored during a specified time. (see also the object "Alarm output ...")
□→	4 ... 7 33 ... 36	Status output x	1-byte object or 2-byte object for outputting of the actual output value.
□←	8 ... 15 37 ... 44	Forced guidance 1/2 output x	1-bit objects which can be used to switch the output by forced guidance to a parameterized value. After deactivation of the forced guidance mode, the output adopts the previous value. When both, forced guidance 1 and force guidance 2 are active, forced guidance 1 has priority. The forced guidance objects can be monitored during a specified time. (see also the object "Alarm output ...")
□←	16 ... 19 45 ... 48	Switching output x	1-bit objects which can be used to switch the output on (100%) or off. This object can be connected, for instance, with the 1-bit object of a dimming key. The object is available in the 8-bit mode only. When cyclical monitoring of the input value is active, the switching object is not monitored.
□←	20 ... 23 49 ... 52	Dimming output x	4-bit object which can be used to increase / decrease the output value continuously with a dimming key. The dimming speed is presettable. As per the KNX standard "Brightness increase" is possible and "Brightness reduction" is not possible. When cyclical monitoring of the input value is active, the dimming object is not monitored.
□→	14 ... 27 53 ... 56	Alarm output x	1-bit object which is being set when the output is overloaded (output current exceeding 10 mA) in the 0 ... 1 V or 0 ... 10 V modes, or when the monitoring time has elapsed in case cyclical monitoring of the communication objects "Input value" and/or "Forced guidance..." is active.

Scope of functions

- For each channel separately programmable:
- Type of signal output (0 ... 10 V, 0 ... 1 V, 0 ... 20 mA, 4 ... 20 mA)
- Format of input value (8-bit or 16-bit) presettable
- Dimming actuator operation (with 8-bit input objects)
- Output value after initialization
- Up to two forced-control modes
- Cyclical monitoring of input values
- Response in the event of exceeding of monitoring time presettable
- Response to bus voltage failure presettable
- Response on return of bus voltage presettable

5. Basic function

The analog actuator 4gang is designed to convert physical quantities (2 bytes) or relative values (1 byte) into analog voltages (0 ... 1 V, 0 ... 10 V) or currents (0 ... 20 mA, 4 ... 20 mA). This property can be used, for instance, to integrate HVAC components such as actuating drives for ventilation shutters or other devices into the KNX system.

In the basic setting, the outputs are shut off ("no function"). The parameter "Signal output..." can be used to select the desired voltage or current signal separately for each output. When an output is activated, the ETS displays further parameters and communication objects. An active output has an "Input value" and a "Status" communication object and – depending on its parameters – also further communication objects.

Each active output has the two parameter pages "Output ... 1/2" and "Output ... 2/2". The first of these parameter pages defines the desired input format (16-bit or 8-bit) and the response after a reset.

8-bit values can be used by a large number of KNX devices, but their resolution is limited. 16-bit values offer high resolution and very high flexibility in adapting themselves to the respective system function. They do require, however, a greater single effort in the elaboration of the parameters.

The second parameter page permits using forced-control objects for higher-priority control, time monitoring of the input objects and a dimming function when relative values are used (1-byte object).

6. Use of 16-bit values

Only in very few technical applications is the full range of values of the 2-byte floating point format really needed. On the other hand, there is a large variety of components converting a general analog value such as voltage or current with their own inherent conversion factor into the most different kinds of physical quantities.

To enable a simple and general conversion, the ETS displays three parameters, when the input format of an output is set to the "16-bit" format. These parameters are used to convert the input value in the 2-byte floating point format into the corresponding output signal.

The two parameters "Input value for 0% output value" and "Input value for 100% output value" are preset in such a way that – together with the common parameter "Factor of the input value" – they cover the desired range of values as fully as possible. For an internal resolution as high as as possible, a small factor should be chosen.

Examples:

To obtain a direct conversion of the input value into volts with an output signal of 0 ... 10 V, the following parameters are recommended:

Input value for 0%:	0
Input value for 100%:	1000
Factor of input value:	0.01

To obtain a conversion of the input value into millivolts with an output signal of 0 ... 10 V, the following parameters are recommended:

Input value for 0%:	0
Input value for 100%:	10000
Factor of input value:	1

In order to be able to use the angle directly as default value in case of a ventilation shutter drive with a mechanical actuation angle of 0 ... 90° and an input voltage of 0 ... 10 V, the following parameters are recommended:

Input value for 0%:	0
Input value for 100%:	9000
Factor of input value:	0.01

The same conversion in reverse is performed by the actuator for the communication object "Status". The status object transmits the new value in the following situations:

When the object "Input value" has been assigned a new value different from the actual output value.

When the output has adopted a new value because a higher priority command has been activated or deactivated by a "Forced guidance" object.

When the output has received a new input telegram, which it does not execute because a forced guidance is active.

Example

The output is set to 9 volts by forced guidance. The "Input value" objects receives a value of 5 volts. This value is not adopted because of the forced guidance condition. The status object reports 9 volts.

The new input value of 5 volts is internally stored and output when the forced guidance condition has ended. The status object reports 5 volts.

When the monitoring time for the communication objects "Input value" and/or "Forced guidance" has elapsed.

7. Use of 8-bit values

When 8-bit values are used, the parameters "Input value for 0%", "Input value for 100%" and "Factor of the input value" are fixed and cannot be changed. The communication objects "Input value" and "Status" therefore correspond to datapoint type 5.001.

7.1 Dimming actuator function

When the format of the input object is set to "8-bit", the ETS displays in addition a 1-bit communication object and a 4-bit communication object for this output. With these objects, the output can be controlled by every push button with a dimming function.

The 1-bit object "Switching" can be used to switch the output optionally on or off. When switched on, the output value adopts 100%.

With the 4-bit object, the output can be dimmed in accordance with datapoint type 3.007. The dimming speed depends on the two parameters "Time between 2 of 255 dimming steps, basis" and "Time between 2 of 255 dimming steps, factor". By default, the time for the range from 0% to 100% is approximately 5 seconds. The shortest time is about 2.5 seconds and the longest about 65,000 seconds (which corresponds to 1083 minutes or about 18 hours).

Depending on the parameter "Response to receiving a value", the output adopts a new value received via the 1-byte object either immediately ("direct approach") or it uses the same dimming speed as in case of control by the 4-bit object ("dimming approach").

When the output receives a new value which is to be taken over by the dimming approach, the status object transmits the new value immediately after reception of the input telegram. In case of control via the 4-bit object, the status object transmits the new value when the dimming cycle is terminated

8. Forced guidance

In the 8-bit and also in the 16-bit mode of operation, each output still has up to two communication objects permitting higher-priority control. In order to make use of these objects, the corresponding parameters "Forced-control object..." must be preset. In the basic configuration, these parameters are set to "non existing". For this reason, the ETS does not show these communication objects.

Forced guidance can be active, when the object value is either "1" or "0". The parameter "Output value with forced guidance" is then used to set a fixed value for the active state. When the "Forced guidance" object becomes inactive thereafter, the output automatically readopts the value that corresponds to the "Input value" object.

When both "Forced guidance" objects are active, the "Forced guidance 1" object internally has priority over the "Forced guidance 2" object.

9. Cyclical monitoring

In order to ensure that there is no output control failure, the actuator can monitor during a predefined time the input and / or the forced guidance mode for each of its outputs. In 8-bit operation, the communication objects "Switching" and "Dimming" are not monitored.

When this monitoring mode is activated, a time between 10 seconds and 2550 seconds (= 42.5 minutes) can be preset. If none of the communication objects receives a telegram during this time, the output adopts the value which can be defined in the parameter "Output value after end of monitoring cycle". With the communication object "Alarm output ...", the output can additionally issue a message.

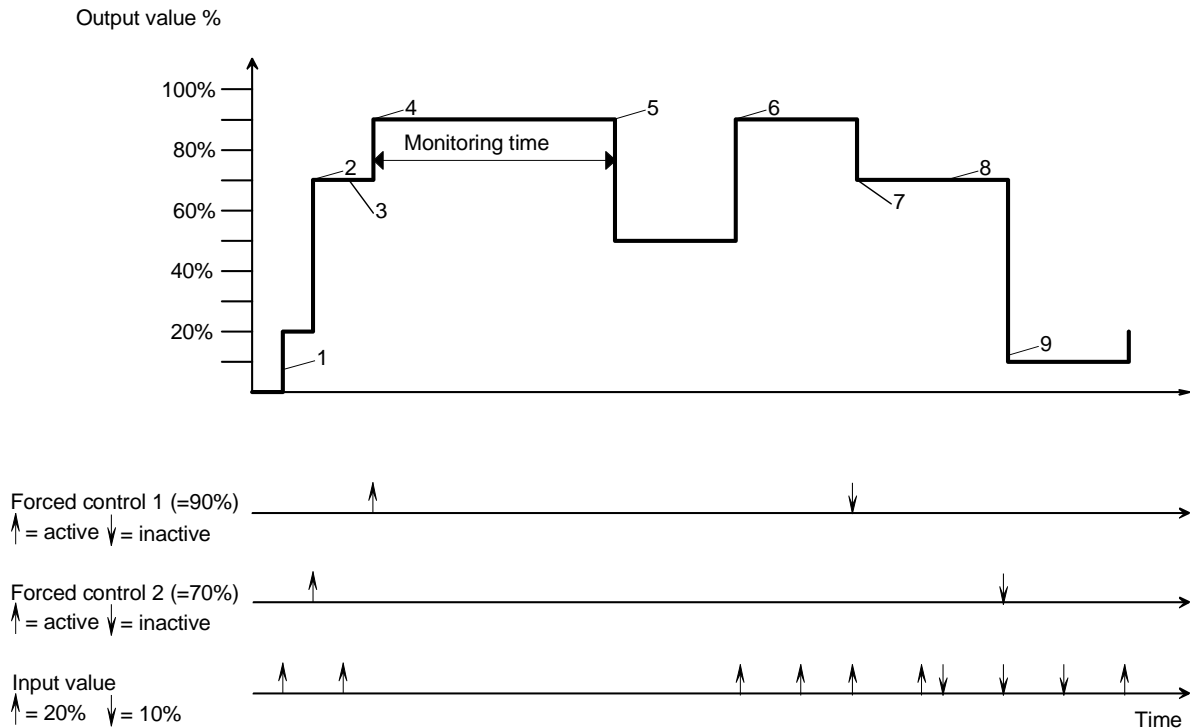

The diagram above shows the interaction of the communication objects "Input value" and "Forced guidance" in conjunction with a monitoring cycle. The arrows indicate the time when a telegram is transmitted.

1. When forced guidance is inactive, the state of the output is determined by the object "Input value".
2. When "Forced guidance 2" becomes active, the output adopts the parameterized value (in this case: 70%).
3. Telegrams addressed to the "Input value" object are not executed. Their value is, however, stored internally.
4. If activated, "Forced guidance 1" has higher priority (in this case: 90%).
5. When the monitoring time is exceeded, the output goes to the alarm state (in this case: 50%).
6. A new telegram addressed to the "Input value" object ends the alarm state. "Forced guidance 1" is again active.
7. When "Forced guidance 1" is terminated, "Forced guidance 2" is again active.
8. Interim changes of the "Input value" object are internally stored, but not executed.
9. When the forced-control state ends, the internally stored input value will be reactivated.

10. Connection with an analog actuator module 4gang

The analog actuator module 4gang permits doubling the number of outputs from 4 to 8.

10.1 Settings of the analog output module / analog actuator module

For the four channels of the analog actuator module 4gang, the software offers the same settings as are applicable for the four inputs of the analog actuator 4gang.

In order to be able to use the extension module, the parameter "Extension module connected" on the general parameter page is to set to "Yes". The ETS will then show the corresponding parameters and communication objects as is the case for the outputs of the analog actuator 4gang.

Besides the communication objects "Alarm output ..." of the individual channels, the analog actuator module 4gang has another alarm communication object which sends a telegram of value "1" when the 24 V AC supply of the extension module fails. On return of the supply, the alarm is reset.

10.2 Electrical connection

When installing an analog actuator module 4gang, the following points must be observed:

- Only one extension module can be connected to the device.
- The connection between the analog actuator 4gang and the extension module must be made only with the system connector supplied with the device.
- An analog actuator module 4gang can be replaced (e.g. in case of defect) while the system is in operation (disconnect the voltage supply from the module). After the replacement, the analog actuator 4gang makes a reset after abt. 25 s. This action re-initializes all outputs and resets them to their original state.
- Removal or addition of modules without adapting the project and subsequent downloading into the analog actuator 4gang is not permitted as this will result in system malfunctions.
- The GND terminals of the analog actuator module 4gang must not be connected to the corresponding terminals of another device, e.g. the analog actuator 4gang.
- The outputs of the analog actuator 4gang and of the analog actuator module 4gang must not be connected to the 1 ... 10 V interface of electronic ballasts or electronic transformers.
- All connected components must ensure safe separation from other voltages.

11. Commissioning and initialization



The analog actuator 4gang is programmed with the ETS.



12. Status indication

After initial start-up, the analog actuator 4gang performs a module scan (status LED: "orange / on"). Since a new device contains generally no project, the status LED switches thereafter to "red / flashing fast".

A connected extension module signals its ready-for-operation state by switching its status LED to "Fast flashing".

After a project has been loaded into the analog actuator 4gang, the status LED switches to "Green / on". The module switches its status LED off.

13. Parameters		
Description	Values	Remarks
 General parameters		
Signal output x	No function 0 ... 10V 0 ... 1V 0 ... 20mA 4 ... 20mA	Each output can either have no function or otherwise work optionally as voltage or current source. When the output has no function, its communication objects and further parameters are hidden. When it is in use, the program displays two additional parameter pages for the output.
Extension module existing	NO YES	This parameter enables the alarm communication object and permits access to the parameters for the outputs 5 to 8
 Output x 1/2		
Input format	16-bit 8-bit	Depending on this parameter, different communication objects are displayed for the input values and the status output. In the 8-bit mode, the output also has a 1-bit object and a 4-bit object. With these objects, it can work like a KNX dimming actuator.
Input format = 16-bit		
Input value for 0% output value	-32768 ... 0 ... 32767	The three parameters "Input value for 0%", "Input value for 100%" and "Factor of output value" can be used for adapting the output characteristics of the actuator to different input values. In order to achieve an internal resolution as high as possible, the two input values should be chosen such that they easily cover the desired range with a factor as small as possible.
Input value for 100% output value	-32768 ... 100 ... 32767	
Factor of input value	Input value * 0.01 Input value * 0.1 Input value * 1 Input value * 10 Input value * 100	
Input format = 8-bit		
Input value for 0% output value	0	In the 8-bit mode, the range of input values is fixed. The function of the output corresponds in this case to the KNX standard for dimming actuators.
Input value for 100% output value	255	
Input format = 8-bit or 16-bit		
Output value after initialization in % (0 ... 100)	0 ... 100	Independent of the size of the input objects, this parameter fixes the output value during an initialization, for instance, after re-programming.
Response to bus voltage failure	Last value Output value in %	When the supply voltage is present, the output can - in the event of bus voltage failure - either retain the last value or otherwise be set to a fixed value.
Output value in % (0 ... 100)	0	In this case, an additional parameter is displayed.
Response on return of bus voltage	No response State of initialization State as before bus voltage failure	On return of bus voltage, the output can optionally retain its actual value, preset the fixed initialization value or restore the condition existing before bus voltage failure.

Input object request on new start	NO YES	When this parameter is set to "Yes", the output can send a read request to the transmitting group address. Thereafter it sets its output to the value received as an answer to the request.
 Ausgang ... 2/2		
Forced guidance object 1 (2) Output value in case of forced guidance 1(2) in % Cyclical monitoring	Not existing Forced guidance active at "1" telegram Forced guidance active at "0" telegram 0 ... 50 ... 100 No monitoring Input value Forced guidance Input value or forced guidance	The two forced guidance objects permit controlling the output with a higher priority than the 1-byte or the 2-byte input object. When this parameter is set to "Not existing", the ETS does not display the corresponding 1-bit object. When the object is in use, the parameter determines at which value of the object the forced guidance is active. When the forced guidance object is switched to inactive, the output adopts the value that corresponds to the object "Input value". If both forced guidance objects are active, forced guidance object 1 has the higher priority. This parameter determines the output value, if the corresponding forced guidance object is active. The output can monitor the "Input value" object and / or the "Forced guidance" objects during a certain time. The non-reception of a telegram within the time defined hereafter is evaluated by the output as an error. In this case, the object "Alarm output ..." can send a telegram with value 1 and the output adopts the value that is preset with the parameter "Output value after exceeding of the monitoring time".
Time factor for cyclical monitoring (1 ... 255, Base = 10 s)	6	Together with the fixed time base, this parameter determines the monitoring time of the output.
Output value after exceeding of the monitoring time in %	0 ... 100	On exceeding of the monitoring time, the output adopts this value.
Input format = 8-bit		
Time between 2 of 255 dimming steps - base Time between 2 of 255 dimming steps - factor (1 ... 255) Response on reception of value	10 ms 2 Direct approach Dimming approach	In the 8-bit mode, these two parameters determine the dimming speed used by the output when controlled via the 4-bit object or when the following parameter is set to ""Dimming approach" and when the output has received a new input value. In the dimming actuator mode, the output can adopt new 1-byte values either directly and immediately or approach them with the usual dimming speed.
 Output x 1/2 like output 1 1/2		
 Output x 2/2 like output 1 2/2		

