

	<h2 style="margin: 0;">application software</h2>	
<ul style="list-style-type: none"> ▲ Manufacturers ▲ Hager Electro ▲ Blinds / shutters <li style="background-color: #e0f0e0; padding: 2px;">▲ Blinds / shutters 	<p style="margin: 0;">1-fold, 4-fold and 8-fold blind/shutter actuator</p> <p style="margin: 0;"><i>Electrical/Mechanical characteristics: see product user manual</i></p>	

	Product reference	Product designation	Application software ref	TP device Radio device
	TYA624A TYA624B TYA624C TYA624D	4-fold shutter actuator 6A 230V AC 4-fold shutter actuator 6A 24V DC 4-fold blind/shutter actuator 6A 230V AC 4-fold blind/shutter actuator 6A 24V DC	STYA624A/B STYA624C/D STYA624A/B STYA624C/D 1.x Version	
	TYA628A TYA628C	8-fold shutter actuator 6A 230V AC 8-fold blind/shutter actuator 6A 230V AC	STYA628A STYA628C 1.x Version	
	TYM632C	12-fold blind/shutter actuator 6A 230V AC	STYM632C 1.x Version	

Content

1. General	4
1.1 About this guide	4
1.2 About the program	4
1.2.1 ETS compatibility	4
1.2.2 Application descriptions	4
2. General Description	5
2.1 Installation of the device	5
2.1.1 Overview presentation	5
2.1.2 Connection	6
2.1.3 Physical addressing	7
2.2 Function modules of the application	8
2.2.1 Primary functions	9
2.2.2 Additional functions	10
3. Parameters	11
3.1 Definition of the general parameters	11
3.1.1 Super alarm	11
3.1.2 Activation of manual mode	12
3.1.3 Activation of the Status indication	12
3.1.4 Activation of the logic blocks	12
3.1.5 Activation of the Device diagnosis object	13
3.1.6 Restore ETS-Parameters	13
3.1.7 Status of the outputs	14
3.1.8 LED display	15
3.2 Super alarm	16
3.2.1 Duration activation and position	17
3.2.2 Super alarm status indication	18
3.3.3 Status indication manual mode	22
3.2.4 Position after super alarm	20
3.3 Manual mode	21
3.3.1 Manual mode activation period	21
3.3.2 Deactivation of manual mode	22
3.3.3 Status indication manual mode	22
3.3.4 Status after manual mode	23
3.4 Status indication	24
3.4.1 Position in % indication object	25
3.4.2 Slat angle in % objects	26
3.4.3 Upper position reached object	27
3.4.4 Lower position reached object	28
3.5 Logic block	29
3.5.1 Configuration of the Logic function	30
3.5.2 Logic block authorization	31
3.5.3 Logic result	33
3.6 Diagnosis	35
3.7 General definition	37
3.7.1 Definition	40
3.7.2 Scene	48
3.7.3 Lock-up	50
3.7.4 Preset	55
3.7.5 Priority	60
3.7.6 Alarm	62
3.7.6.1 Alarm 1 to 3	62
3.7.6.2 Alarm status indication	65
3.7.6.3 Alarm monitoring period	66
3.7.7 Sun protection	67
4. Communication objects	73
4.1 Communication objects General	73
4.1.1 Super alarm	74
4.1.2 Manual mode	75
4.1.3 Logic block	76
4.1.4 Behaviour of the device	77
4.1.5 Diagnosis	77

4.2 Output communication objects	78
4.2.1 Control.....	86
4.2.2 Status indication.....	87
4.2.3 Scene	89
4.2.4 Preset.....	89
4.2.5 Lock-up	90
4.2.6 Priority	91
4.2.7 Alarm.....	92
4.2.8 Sun protection	93
5. Appendix	95
5.1 Specifications	95
5.1.1 TYA624 A/C	95
5.1.2 TYA624 B/D	95
5.1.3 TYA628 B/D	96
5.1.4 TYM632C	97
5.2 Table of logical operations.....	98
5.3 Characteristics.....	98

1. General

1.1 About this guide

The purpose of this manual is to describe the operation and configuration of the KNX-devices using the ETS program. It consists of 4 parts:

- General information.
- Parameter description.
- Overview of KNX objects.
- Technical characteristics.

1.2 About the program

1.2.1 ETS compatibility

The application programs are compatible with ETS4 and ETS5. They can be downloaded from our website under the order number.

ETS Version	File extension of compatible files
ETS4 (V4.1.8 or higher)	*.knxprod
ETS5	*.knxprod

1.2.2 Application descriptions

Application	Product reference
STYA624A/B	TYA624A/B
STYA624C/D	TYA624C/D
STYA628A	TYA628A
STYA628C	TYA628C
STYM632C	TYM632C

2. General Description

2.1 Installation of the device

2.1.1 Overview presentation

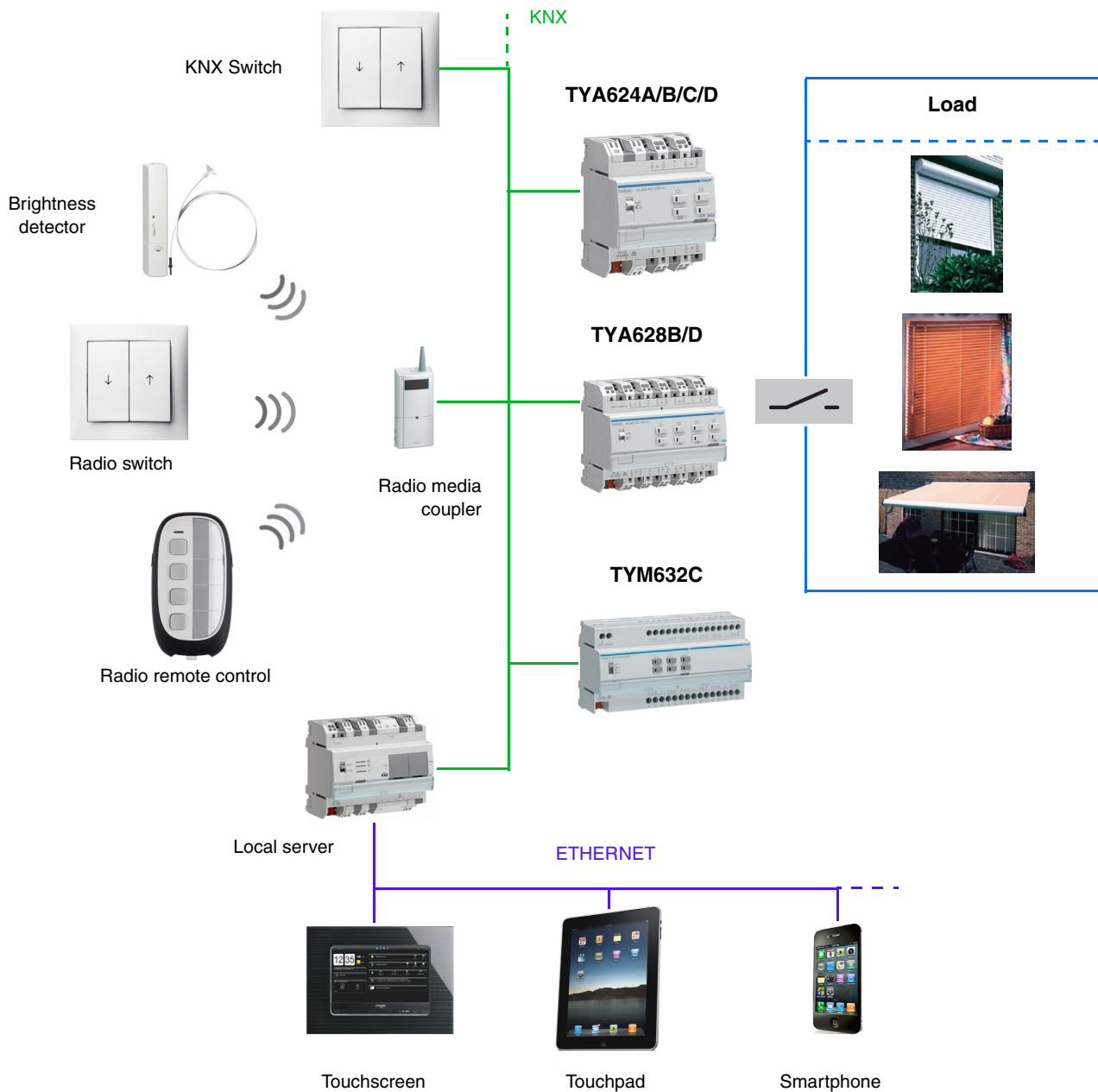

2.1.2 Connection

- TYA624B/D

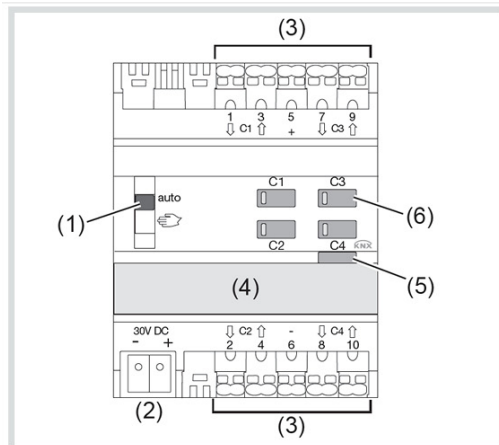

- (1) Slide switch **auto**/☞
- (2) KNX bus connection terminal
- (3) Connections of loads
- (4) Labelling field with cover
- (5) Illuminated programming button
- (6) Operation button for manual operation per output with status LED

- TYA62xA/C

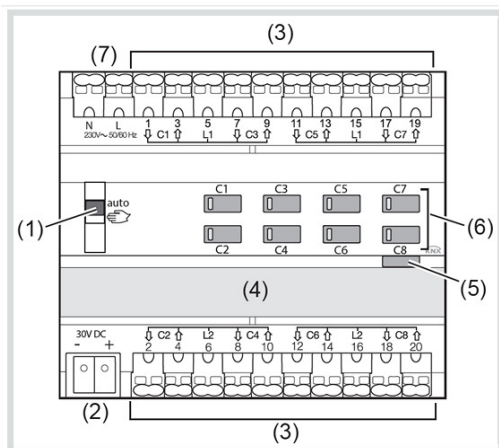

- (1) Slide switch **auto**/☞
- (2) KNX bus connection terminal
- (3) Connections loads
- (4) Labelling field with cover
- (5) Illuminated programming button
- (6) Operation button for manual operation per output with status LED
- (7) Mains power supply connections (only 8gang)

i With the 4gang variant, the basic design corresponds to the 8gang device variant.

- TYM632C

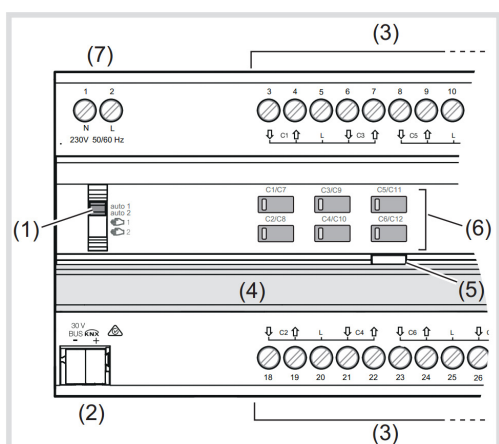

- (1) Slide switch **auto1/auto2**/☞1/☞2
- (2) KNX bus connection terminal
- (3) Connections of loads
- (4) Labelling field with cover
- (5) Illuminated programming button
- (6) Operation button for manual operation per output with status LED
- (7) Mains power supply connection

2.1.3 Physical addressing

In order to perform the physical addressing or to check whether or not the bus is connected, press the lighted push button (5) on the right-hand side above the identification plates on the front of the device.

Light on = bus connected and ready for physical addressing.

Programming mode is activated, until the physical address is transferred from ETS. Pressing the button again, exits programming mode. Physical addressing can be carried out in automatic or manual mode.

2.1.4 Connection

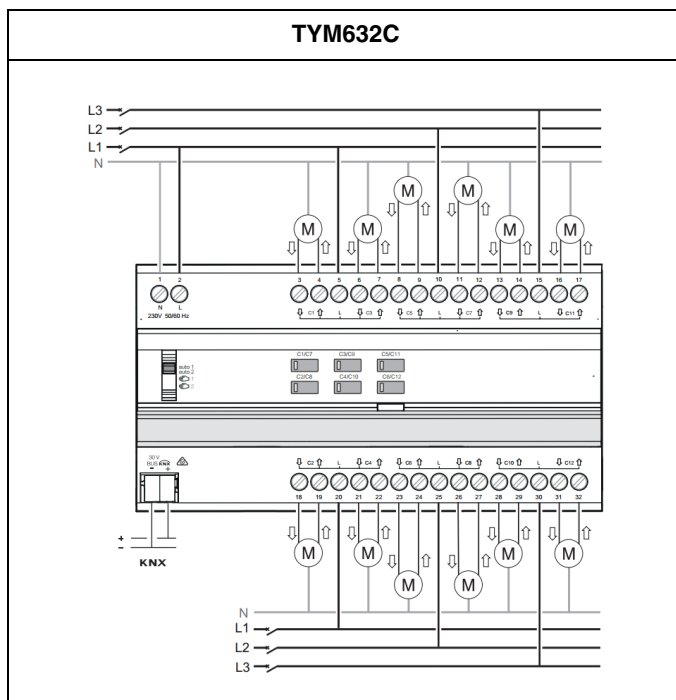
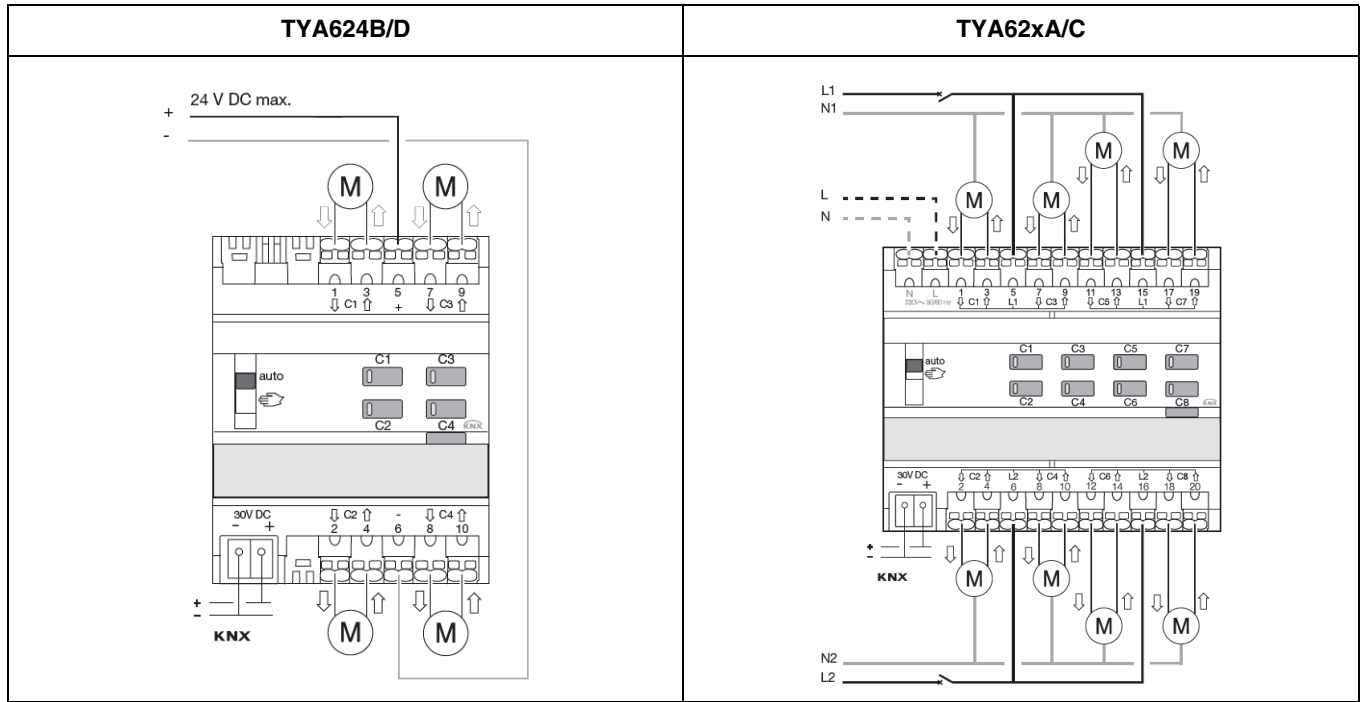

2.2 Function modules of the application

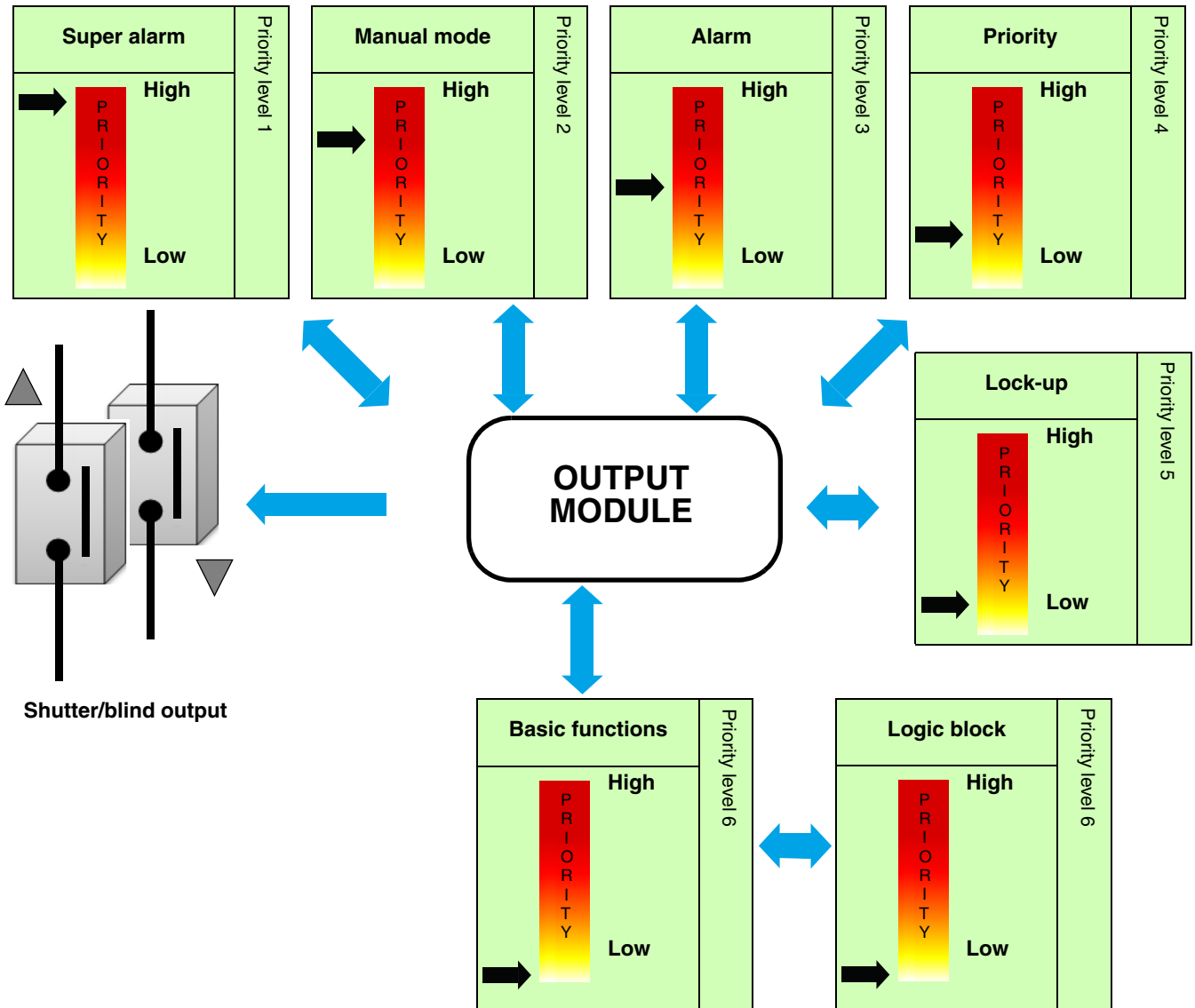

2.2.1 Primary functions

The applications allow individual configuration of the device outputs. The most important functions are:

■ Up/down

The UP/DOWN function is used to run up or down shutters, blinds, awnings, etc. This function can also be used to open and close electric blinds. The command can be given by touch sensors (long press), switches or automatically.

■ Slat position/Stop

The Slat position/Stop function is used to adjust the slats of a blind or to stop its ongoing movement. This function can be used to alter the shade and the incidence of light from outside. The control command may be issued by a push button, for example: A short press on UP/DOWN buttons.

■ Position in %

The Position function is used to bring a shutter or blind to a desired position, which is entered in % lock.

■ Scene

The Scene function is used to switch groups of outputs into a configurable predefined state. A scene is activated by receipt of a 1-byte command. Each output can be included in 64 different scenes.

■ Preset

The Preset function is used to switch an output into various predefined states. The Preset function is activated via an object in 1-bit format.

■ Sun protection

The Sun protection function is used to set the brightness in a room according to the amount of daylight. In general, the position values are sent by an external device (For example, a weather station).

■ Lock-up

The Lock-up function is used to lock the output in a predefined state.

Priority: Super alarm > Manual mode > Alarm > Priority > **Lock-up** > Basic function.

The Lock-up prevents actuation until an unlock command has been received. The Lock-up duration can be set.

■ Priority

The Priority function is used to force the output into a defined state.

Priority: Super alarm > Manual mode > Alarm > **Priority** > Lock-up > Basic function.

Only a Priority OFF command authorizes the output for control.

Application: Maintaining a hanging position for security reasons.

■ Alarm

With the Alarm function a shutter or blind can be positioned in a configurable predefined state. Up to 3 alarm functions are possible.

Priority: Super alarm > Manual mode > **Alarm** > Priority > Lock-up > Basic function.

The alarm prevents any actuation until an alarm cancellation command has been received.

2.2.2 Additional functions

The applications configure the general functions of the devices. The following functions apply to the entire device:

■ Super alarm

This function is used to set all the outputs of the device into a configurable blocked state. All other functions, including manual mode, will be locked. Only a command to cancel the Super alarm will authorize the other commands.

Application: Block all blinds for window cleaning.

■ Manual mode

Manual mode allows the device to be disconnected from the bus. In this mode, each output can be priority controlled locally. The duration of the manual control can be configured.

■ Status indication

The behaviour of the Status indication of each shutter/blind channel can be configured for the entire device.

Using the Status indication function, the following can be sent via the bus:

- Position in % indication: Indicates the position of the shutter or blind.
- Slat angle indication in %: Indicates the slat pitch of the blind.
- Upper or lower position reached: Indicates arrival at the upper or lower position.

■ Logic block

The Logic function is used to control an output depending on the result of a logic operation. This command has the lowest priority. The result of the function can be output on the KNX bus and can directly control one or more outputs. There are 2 logic blocks per device with up to 4 inputs available.

■ Diagnosis

The Device diagnosis function allows notifications about the operating state of the device to be sent via the KNX bus. This information is sent periodically and/or on status change.

3. Parameters

3.1 Definition of the general parameters

This configuration window is used for general configuration of the device. All outputs have these parameters in common.

Device: 1.1.3 8-fold blind actuator 6A 230V AC

Outputs 1-8: Function selection

- O1-8: Manual mode
- O1-8: Status indications
- Output 1: Function selection
- Output 2: Function selection
- Output 3: Function selection
- Output 4: Function selection
- Output 5: Function selection
- Output 6: Function selection
- Output 7: Function selection
- Output 8: Function selection
- Information

Super alarm	Not active
Manual mode	Active
Status indication	Active
Logic block 1	Not active
Logic block 2	Not active
Device diagnosis object	Not active
Activ. of restore ETS-parameters object (scenes, timer, setpoints)	Not active
Parameters overwrite at next download (scenes)	Active
Status during bus power cut	Maintain status
Status after bus power cut	Maintain status
Status after ETS download	Maintain status
Device LED switch off object	Active
Polarity	0 = Status indication, 1 = Always OFF

3.1.1 Super alarm

Parameter	Description	Value
Super alarm	<p>Activation of the Super alarm is not possible.</p> <p>Activation of the Super alarm is possible without time limit.</p> <p>The Super alarm can be activated for a duration that is configurable via the ETS parameters.</p> <p>After expiry of the time limit, the Super alarm is no longer active.</p>	<p>Not active*</p> <p>Active</p> <p>Time limited</p>

Communication objects: [216 - General - Super alarm \(1 bit - 1.005 DPT_Alarm\)](#)

For configuration see section: [Super alarm](#).

* Default value

3.1.2 Activation of manual mode

Parameter	Description	Value
Manual mode	Switching to manual mode is not possible.	Not active*
	Switching to manual mode is possible without time limit.	Active
	Manual mode can be activated for a duration that is configurable via the ETS parameters.	Time limited
	After expiry of the time limit, manual mode is no longer active.	

For configuration see section: [Manual mode](#).

3.1.3 Activation of the Status indication

Parameter	Description	Value
Status indication	The Status indications parameter register is hidden.	Not active
	The Status indications parameter register is displayed.	Active*

For configuration see section: [Status indication](#).

3.1.4 Activation of the logic blocks

Parameter	Description	Value
Logic block 1	Communication object and parameter register Logic block 1 are hidden.	Not active*
	Communication object and parameter register Logic block 1 are displayed.	Active

For configuration see section: [Logic block](#).

Note: The parameters and objects are identical for block 2 ; Only the terms will be adjusted.

For logic block 1

Communication objects: [221 - Logic block 1 - Input 1 \(1 bit - 1.002 DPT_Bool\)](#)
 [225 - Logic block 1 - Logic result \(1 bit - 1.002 DPT_Bool\)](#)

For logic block 2

Communication objects: [227 - Logic block 2 - Input 1 \(1 bit - 1.002 DPT_Bool\)](#)
 [231 - Logic block 2 - Logic result \(1 bit - 1.002 DPT_Bool\)](#)

* Default value

3.1.5 Activation of the Device diagnosis object

Parameter	Description	Value
Device diagnosis object	The Device diagnosis parameter register and the associated communication object is hidden.	Not active*
	The Device diagnosis parameter register and the associated communication object are displayed.	Active

Communication object: [208 - Outputs 1-8 - Diagnosis \(6 byte - Specific\)](#)

For configuration see section: [Diagnosis](#).

3.1.6 Restore ETS-Parameters

There are 2 types of parameters in the device:

- Parameters that can only be changed via ETS.
- Parameters that can be changed via ETS or via the KNX bus.

For parameters that can be changed via ETS and via the KNX bus, 2 values are stored in the device memory: The value corresponding to the ETS-parameter and the currently used value.

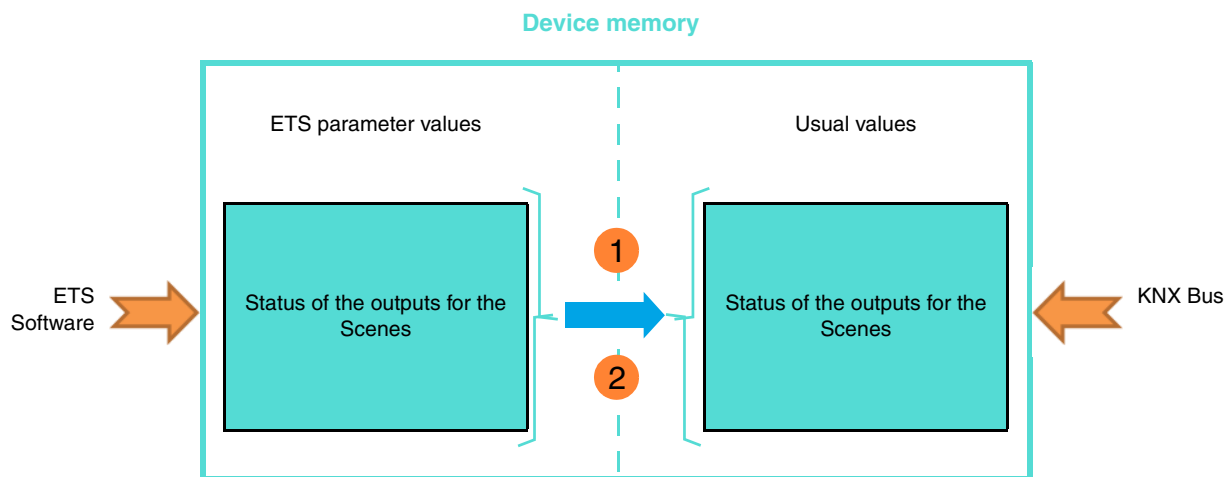

- 1 Receipt of the value 1 on the object, Resets the ETS parameter values:** Current parameter values are replaced by the ETS-parameter values.
- 2 Download of the ETS application:** Current parameter values are replaced by the ETS parameter values on download.

Parameter	Description	Value
Activ. of restore ETS-parameters object (scenes)	The Restore ETS-params settings communication object is hidden.	Not active*
	The Restore ETS-params settings communication object is displayed.	Active
	On receipt of a 1 on this object, the parameters** that are adjustable via the bus are overwritten with values set in the ETS before the last download.	

** Output status for scene X.

Communication object: [208 - Outputs 1-6 - Restore ETS-params settings \(1 bit - 1.015 DPT_Reset\)](#)

* Default value

Parameter	Description	Value
Parameters overwrite at next download (scenes)	The parameter values stored in the device will remain in the device at the next download.	Not active*
	The parameter values stored in the device will be overwritten with the ETS configured values at the next download.	Active

3.1.7 Status of the outputs

Parameter	Description	Value
Status during bus power cut	Maintain the position before the bus power cut.	Maintain status*
	Shutter or blind open.	Up
	Shutter or blind closed.	Down

Parameter	Description	Value
Status after bus power cut	Maintain the position before the bus power cut.	Maintain status*
	Shutter or blind open.	Up
	Shutter or blind closed.	Down
	Run to a specific position.	Specific position

Note: The device will reboot on bus return. The priority functions that were present before the bus power cut, are no longer active (Super alarm, Alarm, Priority, Lock-up).

Parameter	Description	Value
Position after bus power cut	This parameter defines the position to run the shutter or blind to, after the KNXbus power cut.	0 ... 5* ... 100

*Note: This parameter is only visible if the **Status after bus power cut** parameter has the following value: **Specific position**.*

Parameter	Description	Value
Slat angle (0-100%)	This parameter defines the slat position of the blind that is set after a KNX bus power cut.	0 ... 5* ... 100

*Note: This parameter is only visible if the **Status after bus power cut** parameter has the following value: **Specific position**.*

Parameter	Description	Value
Status after ETS download	Maintain the position before download.	Maintain status*
	Shutter or blind open.	Up
	Shutter or blind closed.	Down
	Run to a specific position.	Specific position

Note: During ETS-parameters download, the outputs remain unchanged.

* Default value

Parameter	Description	Value
Position after download	This parameter defines the position to run the shutter or blind to, after download of the ETS parameters.	0 ... 5* ... 100

Note: This parameter is only visible if the **Status after download** parameter has the following value: **Specific position**.

Parameter	Description	Value
Slat angle (0-100%)	This parameter defines the slat position of the blind that is set after download of the ETS-parameters.	0 ... 5* ... 100

Note: This parameter is only visible if the **Status after download** parameter has the following value: **Specific position**.

3.1.8 LED display

Parameter	Description	Value
Device LED switch off object	The Device LEDs lock-up communication object is hidden.	Not active*
	The Device LEDs lock-up communication object is displayed.	Active

This function is used to reduce the overall power consumption of the device. It allows the LEDs on the front of the device to be switched off.

Communication object: [233 - Outputs 1-6 - Device LED switch off \(1 bit - 1.001 DPT_Switch\)](#)

Parameter	Description	Value
Polarity	Object Device LED lock receives: 0 = The LED display is activated 1 = The LED display is deactivated 0 = The LED display is deactivated 1 = The LED display is activated	0 = Status indication, 1 = Always OFF* 0 = Always OFF, 1 = Status indication

Note: This parameter is only visible if the parameter **Device LED switch off object** has the following value: **Active**.

* Default value

3.2 Super alarm

This function is used to block all the outputs of the device in a configurable state. All other functions, including manual mode, will be locked. Only a command to cancel the Super alarm will authorize the other commands. The super alarm is activated on receipt of a 1 on the **Super alarm** communication object.

The behaviour is determined by the following parameters:

Device: 1.1.3 8-fold blind actuator 6A 230V AC

<p>Outputs 1-8: Function selection</p> <ul style="list-style-type: none"> - O1-8: Super alarm - O1-8: Manual mode - O1-8: Status indications <p>Output 1: Function selection</p> <p>Output 2: Function selection</p> <p>Output 3: Function selection</p> <p>Output 4: Function selection</p> <p>Output 5: Function selection</p> <p>Output 6: Function selection</p> <p>Output 7: Function selection</p> <p>Output 8: Function selection</p> <p>Information</p>	<p>WARNING!!! The super alarm locks-up device functions, manual mode included</p> <p>Duration of super alarm (h) <input type="text" value="12"/></p> <p>Duration of super alarm (min) <input type="text" value="0"/></p> <p>Duration of super alarm (s) <input type="text" value="0"/></p> <p>Position during super alarm <input type="text" value="Maintain status"/></p> <p>Super alarm status object <input type="text" value="Active"/></p> <p>Polarity <input type="text" value="0 = deactivated, 1 = activated"/></p> <p>Emission <input type="text" value="On status change"/></p> <p>Alarm monitoring period <input type="text" value="Active"/></p> <p>Hours (h) <input type="text" value="0"/></p> <p>Minutes (min) <input type="text" value="30"/></p> <p>Seconds (s) <input type="text" value="0"/></p> <p>Position after super alarm <input type="text" value="Maintain status"/></p>
--	---

3.2.1 Duration activation and position

Parameter	Description	Value
Duration of super alarm	This parameter defines the time during which the super alarm is active.	12 hours: 0 to 23 h 0 minutes: 0 to 59 min 0 seconds: 0 to 59 s

Note: The smallest executable time is 1 second.

Note: This parameter is only visible if the **Super alarm** parameter has the following value: **Time limited**.

Parameter	Description	Value
Position during super alarm	During the super alarm, the shutter/blind output: Not changed. Closes the Up contact. Closes the down contact. Opens the 2 contacts. Runs to a specific position. Runs to a position set in a scene.	Maintain status* Up Down Stop Specific position Scene number

Parameter	Description	Value
Position (0-100%)	This parameter defines the position to run the shutter or blind to during the super alarm.	0 ... 5* ... 100

Note: This parameter is only visible if the **Position during super alarm** parameter has the following value: **Specific position**.

Parameter	Description	Value
Slat angle (0-100%)	This parameter defines the slat position of the blind that is set during the super alarm.	0 ... 5* ... 100

Note: This parameter is only visible if the **Position during super alarm** parameter has the following value: **Specific position**.

Parameter	Description	Value
Scene	This parameter defines the scene number that is to be applied during the super alarm.	Scene 1 ... 64 Default value: 1

The outputs respond according to the scene numbers and associated parameters.

Note: This parameter is only visible if the **Position during super alarm** parameter has the following value: **Scene number**.

* Default value

3.2.2 Super alarm status indication

Parameter	Description	Value
Super alarm status object	This parameter is used to authorize the Super alarm status object. This object allows the status of the super alarm to be sent from the device on the KNX bus.	Not active* Active

Communication object: [217 - Outputs 1-8 - Super alarm status \(1 bit - 1.011 DPT_State\)](#)

Parameter	Description	Value
Polarity	The Super alarm status object sends: 0 = When the super alarm is deactivated 1 = When the super alarm is activated 0 = When the super alarm is activated 1 = When the super alarm is deactivated	0 = Not active, 1 = Active* 0 = Active, 1 = Not active

Note: This parameter is only visible if the **Super alarm status indication object** parameter has the following value: **Active**.

Parameter	Description	Value
Emission	The object Super alarm status will be sent on: Activation or deactivation of the super alarm. Periodically after a configurable time. On activation or deactivation of the super alarm and periodically.	On status change* Periodically On status change and periodically

Note: This parameter is only visible if the **Super alarm status indication object** parameter has the following value: **Active**.

Parameter	Description	Value
Hours (h)	This parameter determines the time between the individual transmissions of the Super alarm status object.	0 hours: 0 to 23 h
Minutes (min)		10 minutes: 0 to 59 min
Seconds (s)		0 seconds: 0 to 59 s

Note: The smallest executable time is 1 second.

Note: This parameter is only visible if the **Emission** parameter has the following value: **Periodically** or **On status change and periodically**.

* Default value

3.2.3 Alarm monitoring period

Parameter	Description	Value
Alarm monitoring period	<p>The Super alarm object:</p> <p>Expects no periodic signal.</p> <p>Expects a periodic 0 signal.</p> <p>If this signal remains off, the super alarm is automatically activated and the shutters/blinds are run to the position set by the Position during super alarm parameter.</p>	<p>Not active*</p> <p>Active</p>

Parameter	Description	Value
Hours (h)	This parameter defines the maximum time between 2 signals on the Super alarm communication object.	0 hours: 0 to 23 h
Minutes (min)		10 minutes: 0 to 59 min
Seconds (s)		0 seconds: 0 to 59 s

Note: The smallest executable time is 1 second.

*Note: This parameter is only visible if the **Alarm monitoring period** parameter has the following value: **Active**.*

* Default value

3.2.4 Position after super alarm

Parameter	Description	Value
Position after super alarm	After the super alarm, the shutter/blind output: Not changed. Closes the Up contact. Closes the down contact. Runs to a specific position. Runs to a position set in a scene. Returns to the position before super alarm. Runs to the position that would be active according to other communication objects if no super alarm had taken place.	Maintain status* Up Down Specific position Scene number Position before super alarm Theoretical status without super alarm

Note: On setting the **Theoretical status without super alarm**, the Up/Down and slat step commands are not saved.

Parameter	Description	Value
Position (0-100%)	This parameter defines the position to run the shutter or blind to after the super alarm.	0 ... 5* ... 100

Note: This parameter is only visible if the **Position after super alarm** parameter has the following value: **Specific position**.

Parameter	Description	Value
Slat angle (0-100%)	This parameter defines the slat position that is to be applied after the super alarm.	0 ... 5* ... 100

Note: This parameter is only visible if the **Position after super alarm** parameter has the following value: **Specific position**.

Parameter	Description	Value
Scene	This parameter defines the scene number that is to be activated after the super alarm.	Scene 1 ... 64 Default value: 1

The outputs respond according to the scene numbers and associated parameters.

Note: This parameter is only visible if the **Position after super alarm** parameter has the following value: **Scene number**.

* Default value

3.3 Manual mode

In manual mode the device is disconnected from the KNX bus.

The function of the connected load can be checked using the manual mode button. Manual mode can only be activated using the switch on the front of the device. In this mode, telegrams arriving from the KNX bus are ignored.

The behaviour is determined by the following parameters:

Device: 1.1.3 8-fold blind actuator 6A 230V AC

Outputs 1-8: Function selection - O1-8: Manual mode - O1-8: Status indications Output 1: Function selection Output 2: Function selection Output 3: Function selection Output 4: Function selection Output 5: Function selection Output 6: Function selection Output 7: Function selection Output 8: Function selection Information	Duration of manual mode activation (h) <input type="text" value="0"/> Duration of manual mode activation (min) <input type="text" value="30"/> Duration of manual mode activation (s) <input type="text" value="0"/> Object deactivation of manual mode <input type="text" value="Active"/> Polarity <input type="text" value="0=Manual mode authorized, 1=Manual mode locked-l"/> Object status indication manual mode <input type="text" value="Active"/> Polarity <input type="text" value="0=Manual mode deactivated, 1=Manual mode activat"/> Emission <input type="text" value="On status change"/> Position after manual mode <input type="text" value="Maintain status"/>
---	---

3.3.1 Manual mode activation period

Parameter	Description	Value
Duration of manual mode activation	This parameter defines the amount of time for which manual mode remains activated.	0 hours: 0 to 23 h 30 minutes: 0 to 59 min 0 seconds: 0 to 59 s

Note: The smallest executable time is 1 second.

*Note: This parameter is only visible if the **Manual mode** parameter has the following value: **Time limited**.*

3.3.2 Deactivation of manual mode

Parameter	Description	Value
Object deactivation of manual mode	The Deactivation of manual mode communication object is hidden.	Not active*
	The Deactivation of manual mode communication object is displayed.	Active

Communication object: [218 - Outputs 1-8 - Deactivation of manual mode \(1 bit - 1.001 DPT_Switch\)](#)

Parameter	Description	Value
Polarity	The Deactivate manual mode object receives: 0 = Manual mode is activated 1 = Manual mode is not activated	0 = Manual mode authorized, 1 = Manual mode locked-up*
	0 = Manual mode is not activated 1 = Manual mode is activated	0 = Manual mode locked-up, 1 = Manual mode authorized

Note: This parameter is only visible if the **Object deactivation of manual mode** parameter has the following value: **Active**.

3.3.3 Status indication manual mode

Parameter	Description	Value
Object status indication manual mode	The Status indication manual mode communication object is hidden.	Not active*
	The Status indication manual mode communication object is displayed.	Active

Communication object: [219 - Outputs 1-8 - Status indication manual mode \(1 bit - 1.011 DPT_State\)](#)

Parameter	Description	Value
Polarity	The Status indication manual mode communication object sends: 0 = When manual mode is switched on 1 = When manual mode is switched off	0 = Manual mode active, 1 = Manual mode not active
	0 = When manual mode is switched off 1 = When manual mode is switched on	0 = Manual mode not active, 1 = Manual mode active*

Note: This parameter is only visible if the **Object status indication manual mode** parameter has the following value: **Active**.

Parameter	Description	Value
Emission	The Status indication manual mode communication object is sent: On switching manual mode on or off.	On status change*
	Periodically after a configurable time.	Periodically
	On switching manual mode on or off and periodically after a configurable time.	On status change and periodically

Note: This parameter is only visible if the **Object status indication manual mode** parameter has the following value: **Active**.

* Default value

Parameter	Description	Value
Hours (h)	This parameter determines the time between the individual transmissions of the Status indication manual mode object.	0 hours: 0 to 23 h
Minutes (min)		10 minutes: 0 to 59 min
Seconds (s)		0 seconds: 0 to 59 s

Note: The smallest executable time is 1 second.

*Note: This parameter is only visible if the **Emission** parameter has the following value: **Periodically** or **On status change and periodically**.*

3.3.4 Status after manual mode

Parameter	Description	Value
Status after manual mode	After manual mode, the shutter/blind output: Not changed. Closes the Up contact. Closes the down contact. Runs to a specific position. Returns to the position before super alarm. Runs to the position that would be active according to other communication objects if no super alarm had taken place.	Maintain status* Up Down Specific position Position before manual mode Theoretical status without manual mode

*On setting the **Theoretical status without super alarm**, the Up/Down and slat step commands are not saved.*

Parameter	Description	Value
Position (0-100%)	This parameter defines the position to run the shutter or blind to after manual mode.	0 ... 5* ... 100

*Note: This parameter is only visible if the **Status after manual mode** parameter has the following value: **Specific position**.*

Parameter	Description	Value
Slat angle (0-100%)	This parameter specifies the slat position of the blinds that is to be set after the end of manual mode.	0 ... 5* ... 100

*Note: This parameter is only visible if the **Status after manual mode** parameter has the following value: **Specific position**.*

* Default value

3.4 Status indication

Using the Status indication function, the following can be sent via the bus:

- Position in % indication: Indicates the position of the shutter or blind.
- Slat angle indication in %: Indicates the slat pitch of the blind.
- Upper or lower position reached: Indicates that the shutter or blind has reached the upper or lower position.

The conditions for emission of the object values are on a change in the output, periodically or both of these simultaneously.

Device: 1.1.3 8-fold blind actuator 6A 230V AC

Outputs 1-8: Function selection - O1-8: Manual mode - O1-8: Status indications Output 1: Function selection Output 2: Function selection Output 3: Function selection Output 4: Function selection Output 5: Function selection Output 6: Function selection Output 7: Function selection Output 8: Function selection Information	Position in % objects: Active Emission position objects during manual mode: Not active Emission: On status change Time delay for position objects (h): 0 Time delay for position objects (min): 0 Time delay for position objects (s): 20 Slat angle in objects: Active Emission during manual mode: Not active Emission: On status change Time delay for slat angle objects (h): 0 Time delay for slat angle objects (min): 0 Time delay for slat angle objects (s): 20 Upper position reached objects: Not active Lower position reached objects: Not active
---	---

3.4.1 Position in % indication object

Parameter	Description	Value
Position in % objects	This parameter is used to display all the Position in % indication object related parameters.	Active* Not active

Parameter	Description	Value
Emission position objects during manual mode	The Position in % indication object sends: Values after a change of position in manual mode. No values after a change of position in manual mode.	Active Not active*

Parameter	Description	Value
Emission	The Position in % indication communication object is sent: After each position change. Periodically after a configurable time. After a position change and periodically after a configurable time.	On status change* Periodically On status change and periodically

Parameter	Description	Value
Hours (h) Minutes (min) Seconds (s)	This parameter determines the time between the individual transmissions of the Position in % indication object.	0 hours: 0 to 23 h 30 minutes: 0 to 59 min 0 seconds: 0 to 59 s

Note: The smallest executable time is 1 second.

*Note: This parameter is only visible if the **Emission** parameter has the following value: **Periodically** or **On status change and periodically**.*

Parameter	Description	Value
Time delay for position objects	This parameter determines the delay for emission of the Position in % indication object on return of the KNX bus after a power cut.	1 hours: 0 to 23 h 0 minutes: 0 to 59 min 0 seconds: 0 to 59 s

Note: The smallest executable time is 1 second.

Note: This parameter can be used to optimize the bus load after the return of the KNX bus voltage.

* Default value

3.4.2 Slat angle in % objects

Parameter	Description	Value
Slat angle in % objects	This parameter is used to display all the Slat angle indication in % object related parameters.	Active* Not active

Parameter	Description	Value
Emission during manual mode	The Slat angle indication in % object sends: Values after a change of position in manual mode. No values after a change of position in manual mode.	Active Not active*

Parameter	Description	Value
Emission	The Slat angle indication in % communication object is sent: After each position change. Periodically after a configurable time. After a position change and periodically after a configurable time.	On status change* Periodically On status change and periodically

Parameter	Description	Value
Hours (h) Minutes (min) Seconds (s)	This parameter determines the time between the individual transmissions of the Slat angle indication in % objects.	0 hours: 0 to 23 h 30 minutes: 0 to 59 min 0 seconds: 0 to 59 s

Note: The smallest executable time is 1 second.

*Note: This parameter is only visible if the **Emission** parameter has the following value: **Periodically** or **On status change and periodically**.*

Parameter	Description	Value
Time delay for slat angle objects	This parameter determines the delay for emission of the Slat angle indication in % object on return of the KNX bus after a power cut.	0 hours: 0 to 23 h 0 minutes: 0 to 59 min 10 seconds: 0 to 59 s

Note: The smallest executable time is 1 second.

Note: This parameter can be used to optimize the bus load after the return of the KNX bus voltage.

* Default value

3.4.3 Upper position reached object

Parameter	Description	Value
Upper position reached objects	This parameter is used to display all the Upper position reached object related parameters.	Active Not active*

Parameter	Description	Value
Polarity	The Upper position reached object sends: 0 on leaving the upper position 1 on reaching the upper position 0 on reaching the upper position 1 on leaving the upper position	0 = Position not reached, 1 = Position reached* 0 = Position reached, 1 = Position not reached

Parameter	Description	Value
Emission during manual mode	The Upper position reached object sends: Values on reaching the end position in manual mode. No values on reaching the end position in manual mode.	Active Not active*

Parameter	Description	Value
Emission	The Upper position reached object sends: On reaching or leaving the final position. Periodically after a configurable time. After a position change and periodically after a configurable time.	On status change* Periodically On status change and periodically

Parameter	Description	Value
Hours (h) Minutes (min) Seconds (s)	This parameter determines the time between the individual transmissions of the Upper position reached object.	0 hours: 0 to 23 h 30 minutes: 0 to 59 min 0 seconds: 0 to 59 s

Note: The smallest executable time is 1 second.

*Note: This parameter is only visible if the **Emission** parameter has the following value: **Periodically** or **On status change and periodically**.*

Parameter	Description	Value
Time delay for upper position objects	This parameter determines the delay for emission of the Upper position reached object on return of the KNX bus after a power cut.	0 hours: 0 to 23 h 0 minutes: 0 to 59 min 20 seconds: 0 to 59 s

Note: The smallest executable time is 1 second.

Note: This parameter can be used to optimize the bus load after the return of the KNX bus voltage.

* Default value

3.4.4 Lower position reached object

Parameter	Description	Value
Lower position reached objects	This parameter is used to display all the Lower position reached object related parameters.	Active Not active*

Parameter	Description	Value
Polarity	The Lower position reached object sends: 0 on leaving the lower position 1 on reaching the lower position 0 on reaching the lower position 1 on leaving the lower position	0 = Position not reached, 1 = Position reached* 0 = Position reached, 1 = Position not reached

Parameter	Description	Value
Emission during manual mode	The Lower position reached object sends: Values on reaching the end position in manual mode. No values on reaching the end position in manual mode.	Active Not active*

Parameter	Description	Value
Emission	The Lower position reached communication object is sent: On reaching or leaving the final position. Periodically after a configurable time. After a position change and periodically after a configurable time.	On status change* Periodically On status change and periodically

Parameter	Description	Value
Hours (h) Minutes (min) Seconds (s)	This parameter determines the time between the individual transmissions of the Lower position reached object.	0 hours: 0 to 23 h 30 minutes: 0 to 59 min 0 seconds: 0 to 59 s

Note: The smallest executable time is 1 second.

Note: This parameter is only visible if the **Emission** parameter has the following value: **Periodically** or **On status change and periodically**.

Parameter	Description	Value
Time delay for lower position objects	This parameter determines the delay for emission of the Lower position reached object on return of the KNX bus after a power cut.	0 hours: 0 to 23 h 0 minutes: 0 to 59 min 20 seconds: 0 to 59 s

Note: The smallest executable time is 1 second.

Note: This parameter can be used to optimize the bus load after the return of the KNX bus voltage.

* Default value

3.5 Logic block

The Logic function is used to control an output depending on the result of a logic operation. This command has the lowest priority. The result of the function can be output on the KNX bus and may directly relate to the status of one or more outputs. 2 logic blocks are available for each device.

The behaviour is determined by the following parameters:

Note: The description of the parameters is given for logic block 1. The parameters and objects are identical for logic block 2 ; Only the terms will be adjusted.

Device: 1.1.3 8-fold blind actuator 6A 230V AC

<ul style="list-style-type: none"> Outputs 1-8: Function selection - O1-8: Manual mode - O1-8: Status indications <li style="background-color: #e0e0e0;">- O1-8: Logic block 1 - O1-8: Logic block 2 Output 1: Function selection Output 2: Function selection Output 3: Function selection Output 4: Function selection Output 5: Function selection Output 6: Function selection Output 7: Function selection Output 8: Function selection Information 	<p>Logic function type: OR</p> <p>Number of logic input: 1</p> <p>Inverting value of logic input 1: Maintain status</p> <p>Value at initialization logic input 1: Value before initialization</p> <p>Authorization object logic block: Not active</p> <p>Emission of logic result: By logic result value change</p> <p>Logic result acts on outputs: Active</p> <p>Output 1: Yes</p> <p>Output 2: Yes</p> <p>Output 3: Yes</p> <p>Output 4: Yes</p> <p>Output 5: Yes</p> <p>Output 6: Yes</p> <p>Output 7: Yes</p> <p>Output 8: Yes</p> <p>Action if logic result = 0: Maintain status</p> <p>Action if logic result = 1: Maintain status</p>
--	---

Operating principle of the logic block:

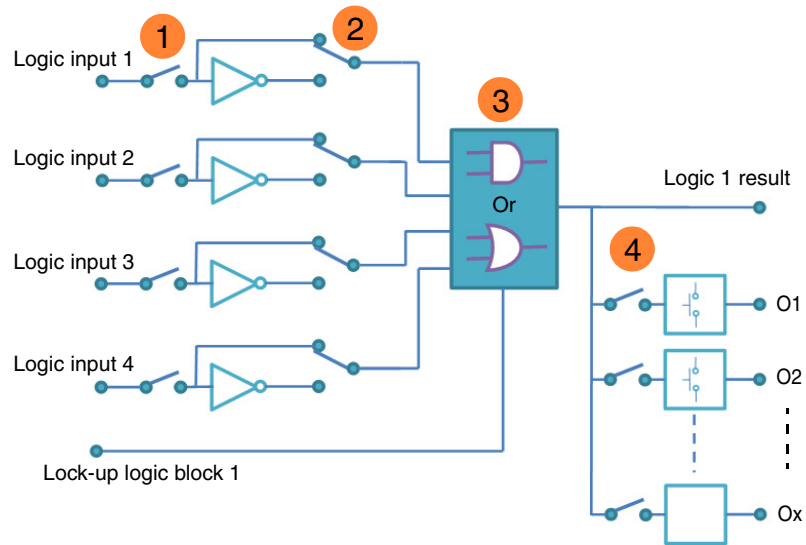

- ❶ Logic input number: Allows authorization of the logic input
- ❷ Logic input value: Inverted, yes or no
- ❸ Type of logic function (AND or OR): Selection of the logic function
- ❹ The logic result is applied to outputs: Selection of the outputs concerned by the logic operation

3.5.1 Configuration of the Logic function

Parameter	Description	Value
Logic function type	The input objects are: OR linked. AND linked.	Or* And

For logic table see: [Appendix](#).

Parameter	Description	Value
Number of logic inputs	This parameter determines the number of inputs of the logic block. Up to 4 inputs can be used.	1* 2 3 4

Communication objects:

- Block 1
 - 222 - Logic block 1 - Input 2 (1 bit - 1.002 DPT_Bool)
 - 223 - Logic block 1 - Input 3 (1 bit - 1.002 DPT_Bool)
 - 224 - Logic block 1 - Input 4 (1 bit - 1.002 DPT_Bool)
- Block 2
 - 228 - Logic block 2 - Input 2 (1 bit - 1.002 DPT_Bool)
 - 229 - Logic block 2 - Input 3 (1 bit - 1.002 DPT_Bool)
 - 230 - Logic block 2 - Input 4 (1 bit - 1.002 DPT_Bool)

* Default value

Parameter	Description	Value
Inverting value of logic input x	The value of logic input x works on the logic block: With its object value (0=0, 1=1). With inverted object value (0=1, 1=0).	Maintain status* Status inversion

x = 1 to 4

Parameter	Description	Value
Value at initialization of logic input x	On initialization of the device after a download or after return of the bus power, the value of the logic input is: Set to 0. Set to 1. Set according to the value of the logic input before the initialization occurred.	0 1 Value before initialization*

3.5.2 Logic block authorization

Principle of logic block authorization:

The parameters are set as follows:

- Logic block authorization: 0 = Locked-up, 1 = Authorized.
- Action if logic result = 0 : Scene 1.
- Action if logic result = 1 : Scene 2.
- Logic input 1 and 2 are AND-linked.
- Emission of logic result: By input value change.

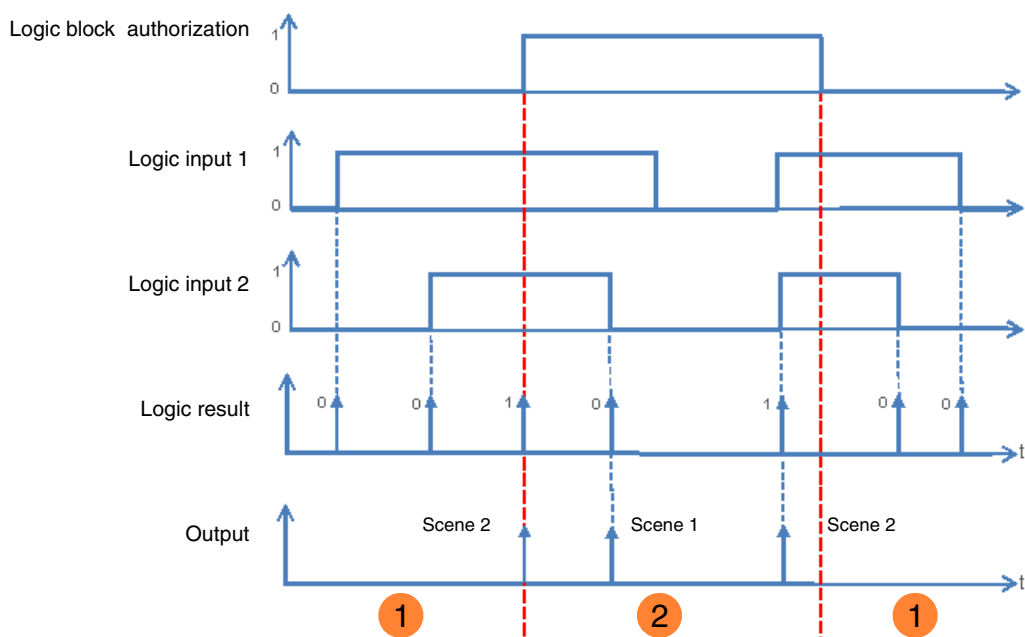

- 1 The logic result has no influence on the outputCurrent values.
- 2 The commands from the logic result are executed.

Note: The commands from the logic result are executed immediately after authorization, according to the **Logic result after authorization** parameter.

* Default value

Parameter	Description	Value
Authorization object logic block	The Logic block 1 – Authorization communication object and related parameters are hidden.	Not active*
	The Logic block 1 – Authorization communication object and related parameters are displayed.	Active

Note: If the logic block is locked the logic operation is not processed.

Communication objects: Block 1 **220 - Logic block 1 - Authorization** (1 bit - 1.003 DPT_Enable)
 Block 2 **226 - Logic block 2 - Authorization** (1 bit - 1.003 DPT_Enable)

Parameter	Description	Value
Value at initialization	On initialization of the device after a download or after return of the bus power, the value of the Logic block 1 – Authorization object is:	
	Set to 0.	0
	Set to 1.	1
	Set according to the value that the object had before initialization.	Value before initialization*

*Note: This parameter is only visible if the **Authorization object logic block** parameter has the following value: **Active**.*

Parameter	Description	Value
Polarity	On receipt of a value on the Logic block 1 – Authorization object, this is:	
	Locked-up on object value 1.	0 = Authorized, 1 = Locked-up
	Locked-up on object value 0.	0 = Locked-up, 1 = Authorized*

*Note: This parameter is only visible if the **Authorization object logic block** parameter has the following value: **Active**.*

Parameter	Description	Value
Logic result after autorisation	On authorization of the logic block:	
	The value of the Logic result is immediately determined.	Immediate emission when authorization*
	The value of the logic result is first determined after receipt of a value on a logic input.	No immediate emission

*Note: This parameter is only visible if the **Authorization object logic block** parameter has the following value: **Active**.*

* Default value

3.5.3 Logic result

Parameter	Description	Value
Emission of logic result	The Logic result object will be sent on: Each receipt of a telegram on one of the logic inputs. A change in the value of the logic result.	By input value change By logic result value change*

Parameter	Description	Value
Logic result acts on outputs	The logic results acts: Only on the Logic result communication object. On the Logic result communication object and directly on one or more outputs.	Not active* Active

The status of the affected outputs is determined by the parameter **action on logic result = x**.

Parameter	Description	Value
Output 1 ... x	The output relationship with the Logic result is: Directly dependent. Independent.	Yes* No

*Note: This parameter is only visible if the **Logic result acts on outputs** parameter has the following value: **Active**.*

Parameter	Description	Value
Action if logic result = 0	Outputs that are directly dependent on Logic 1 result will, on output value 0: Not changed. Closes the Up contact. Closes the down contact. Opens the 2 contacts. Runs to a specific position. Runs to a position set in a scene. Run to the default position set in the Status if preset 1 object = 0 parameter Run to the default position set in the Status if preset 2 object = 0 parameter	Maintain status* Up Down Stop Specific position Scene number Preset 1 Preset 2

Note: The Scene function or Preset function of the selected output must be configured. If this is not the case, the status remains unchanged.

Parameter	Description	Value
Position (0-100%)	This parameter determines the position of the shutter or blind to be activated if the logic result is 0 after re-evaluation.	0 ... 5* ... 100

*Note: This parameter is only visible if the **Action if logic result = 0** parameter has the following value: **Specific position**.*

* Default value

Parameter	Description	Value
Slat angle (0-100%)	This parameter determines the slat position of the blind to be set if the logic result is 0 after re-evaluation.	0 ... 5* ... 100

Note: This parameter is only visible if the **Action if logic result = 0** parameter has the following value: **Specific position**.

Parameter	Description	Value
Scene if logic result = 0	This parameter determines the scene number that is activated if the logic result is 0 after re-evaluation.	Scene 1 ... 64 Default value: 1

The outputs respond according to the scene numbers and associated parameters.

Note: This parameter is only visible if the **Action if logic result = 0** parameter has the following value: **Scene number**.

Parameter	Description	Value
Action if logic result = 1	Outputs that are directly dependent on Logic 1 result will, on output value 1: Not changed. Closes the Up contact. Closes the down contact. Opens the 2 contacts. Runs to a specific position. Runs to a position set in a scene. Run to the default position set in the Status if preset 1 object = 0 parameter Run to the default position set in the Status if preset 2 object = 0 parameter	Maintain status* Up Down Stop Specific position Scene number Preset 1 Preset 2

Note: The Scene function or Preset function of the selected output must be configured. If this is not the case, the status remains unchanged.

Parameter	Description	Value
Position (0-100%)	This parameter determines the position of the shutter or blind to be activated if the logic result is 1 after re-evaluation.	0 ... 5* ... 100

Note: This parameter is only visible if the **Action if logic result = 1** parameter has the following value: **Specific position**.

Parameter	Description	Value
Slat angle (0-100%)	This parameter determines the slat position of the blind to be set if the logic result is 1 after re-evaluation.	0 ... 5* ... 100

Note: This parameter is only visible if the **Action if logic result = 1** parameter has the following value: **Specific position**.

Parameter	Description	Value
Scene if logic result = 1	This parameter determines the scene number that is activated if the logic result is 1 after re-evaluation.	Scene 1 ... 64 Default value: 1

The outputs respond according to the scene numbers and associated parameters.

Note: This parameter is only visible if the **Action if logic result = 1** parameter has the following value: **Scene number**.

* Default value

3.6 Diagnosis

The **Device diagnosis** object allows notifications about the operating status of the device to be sent via the KNX bus. This information is sent periodically and/or on status change.

The **Device diagnosis** object allows reporting of current faults according to the device and application. It also allows sending of the position of the switch on the front of the device and the number of the output that is affected by the fault(s).

The **Device Diagnosis** object is a 6-byte object that is composed as described below:

Byte number	6 (MSB)	5	4	3	2	1 (LSB)
Use	Switch position	Application type	Output number	Error codes		

Details of the byte:

- **Bytes 1 to 4:** Correspond to the error codes.

MSB

LSB

b31	b30	b29	b28	b27	b26	b25	b24	b23	b22	b21	b20	b19	b18	b17	b16	b15	b14	b13	b12	b11	b10	b9	b8	b7	b6	b5	b4	b3	b2	b1	b0
32	X	X	X	28	27	X	X	X	X	X	X	X	X	X	X	X	X	X	X	X	X	X	9	X	X	X	X	X	X	X	X

N°	Faults
27	Wrong context: The user's parameters are not transferable. The standard parameters are restored.
28	TP communication out of operation: Communication via the KNX bus was not available on the previous start.
32	Minimum switching time not complied with: The device is equipped with a mechanism for limiting the number of switching cycles per minute of the output contact. If the user requires a number of switching cycles that is greater than this limit, this bit informs the user that his command was not carried out.
9	Excessive number of restarts: This bit is use for notification of repeated restarts and/or a restart triggered by a Watch-Dog. Such a restart is not necessarily apparent to the user from the function, rather it is manifest as a disturbed environment or a bad contact of the power supply.

Note: The use of the standard bit depends on the type of device used (switch actuator, dimmer, shutter/blind, etc.). Certain bit are same for all devices and others are application-specific.

- **Byte 5:** Corresponds to the application type and the number of the output affected by the error.

MSB

LSB

b7	b6	b5	b4	b3	b2	b1	b0
Application type				Output number			
0 = Not defined				0 = Device error			
1 = Switch actuator				1 = Output 1			
2 = Shutter/blind				2 = Output 2			
3 = Dimmer						
				Y = Output Y			

Note: Y is the placeholder for the maximum number of outputs.

- **Byte 6:** Switch position.

MSB							LSB
b7	b6	b5	b4	b3	b2	b1	b0
X	X	X	X	X	X	X	1

1: 0 = Automatic mode / 1 = Manual mode

Note: Bit marked with an x are not used.

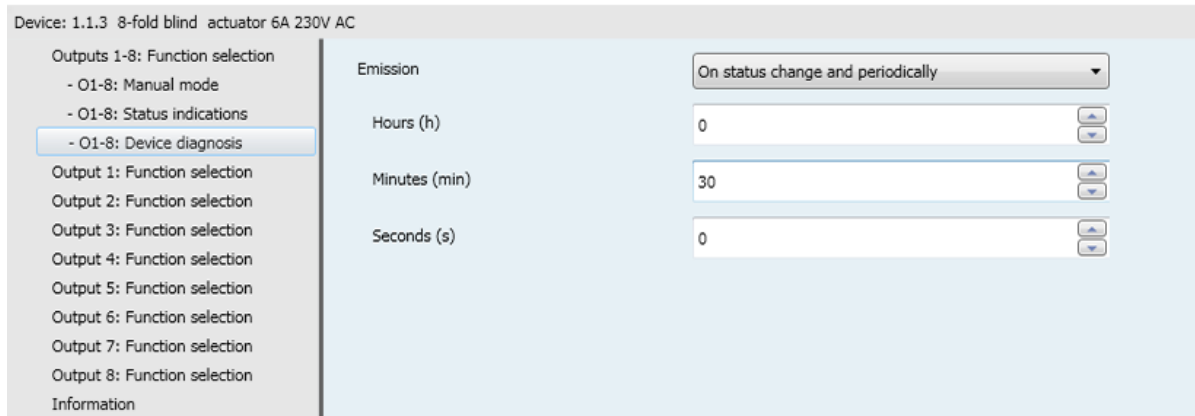

Parameter	Description	Value
Emission	The Device diagnosis communication object is sent to bus: On each change. Periodically after a configurable time. On change and periodically after a configurable time.	On status change* Periodically On status change and periodically

Parameter	Description	Value
Hours (h)	This parameter determines the time between the individual transmissions of the Device diagnosis object.	0 hours: 0 to 23 h
Minutes (min)		30 minutes: 0 to 59 min
Seconds (s)		0 seconds: 0 to 59 s

Note: The smallest executable time is 1 second.

*Note: This parameter is only visible if the **Emission** parameter has the following value: **Periodically** or **On status change and periodically**.*

* Default value

3.7 General definition

Device: 1.1.3 8-fold blind actuator 6A 230V AC

<ul style="list-style-type: none"> Outputs 1-8: Function selection - O1-8: Manual mode - O1-8: Status indications Output 1: Function selection Output 2: Function selection Output 3: Function selection Output 4: Function selection Output 5: Function selection Output 6: Function selection Output 7: Function selection Output 8: Function selection Information 	<p>Closing type for channel 1: Shutter and blind</p> <p>Complete up movement duration (min): 2</p> <p>Complete up movement duration (s): 0</p> <p>Complete down movement duration (min): 2</p> <p>Complete down movement duration (s): 0</p> <p>Time delay for direction inversion (ms): 600</p> <p>Relay closing time for slat positioning (ms): 150</p> <p>Total number of slat angles: 12</p> <p>Secured down: Not active</p> <p>Manual mode active for output 1: Yes</p> <p>Status indication: Yes</p> <p>Status indication position in %: Active</p> <p>Status indication slat angle in %: Active</p> <p>Status indication upper position reached: Not active</p> <p>Status indication lower position reached: Not active</p> <p>Scene: Not active</p> <p>Lock-up: Not active</p> <p>Preset: Not active</p> <p>Priority: Not active</p> <p>Alarm: Not active</p> <p>Reactivate sun protection: Not active</p>
--	--

Slat position for horizontal slats

The blind drive actuators have 2 limit position switches and can be run to a Sun protection position using a position setting in percent. The value of 0% is used to control the upper position (i.e. Sun protection fully open) or is reported as a status.

Sun protection open (Upper position: 0%)

Object: Position in %



If the lower position is to be approached, then this will be sent to the blinds as Sun protection position 100% or on reaching the lower position (i.e. Sun protection completely closed). The position will be reported using this value. If a blind is run from the upper position, the slats initially tilt into an almost vertical position and then the sun protection runs with closed slats to the lower position.

When the blind is located at the lower position and the slats are fully closed, then this slat position is described as vertical and equal to 100%. Normally, however, fully closed slats have no exactly vertical position ($\alpha = 180^\circ$) but rather form a small angle with the vertical.

Sun protection closed slats (Lower position: 100%, Slat angle: 100%)

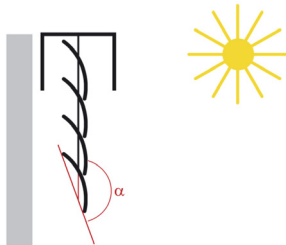

Object: Position in %

From their vertical position (completely closed, 100%) the slats can be adjusted to their horizontal position (fully open, 0% and = 90°) The blind drive used thus determines whether this adjustment can be carried out using many small steps or whether it is only possible via a few large steps (As with most standard drives).

Slat position horizontal (0%, $\alpha = 90^\circ$)

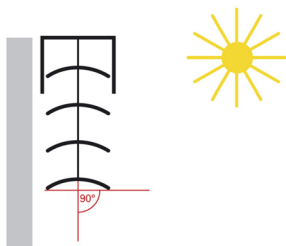

Object: Slat angle in %

For standard blinds, the slats can be adjusted continuously to the horizontal position or until the slat adjustment ends and the raising of the blind begins. The slats then form an angle of between 0° and 90° with the vertical.

Slat position at the start of moving the blind (Up)

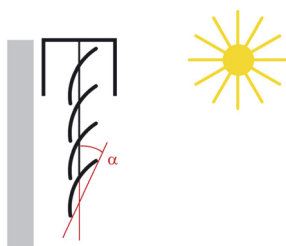

Object: Slat angle in %

Slat position for vertical slats

If an interior shade or privacy shield with vertical slats is controlled via a blind actuator, then the position in which the slats are fully open is controlled or reported as the 0% slat position. The slats then form an angle of 90° with the direction of travel from Shade fully open to Shade fully closed.

Fully opened vertical slats (Slat angle 0%)

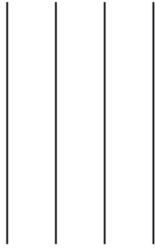

Object: Slat angle in %

If the slats are fully closed, this position will be controlled and reported as slat position 100%. This is the position to which the shade is run from its side limit position in front of the window. The angle that the slats then form with the direction of movement is therefore a little $> 0^\circ$.

Fully closed vertical slats (Slat angle 100%)

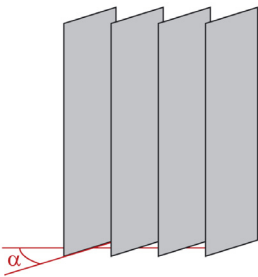

Object: Slat angle in %

If the shade is then driven back (i.e. opened), then the vertical slats are turned to a position that is somewhat smaller than 180° .

Vertical slats at the start of moving UP

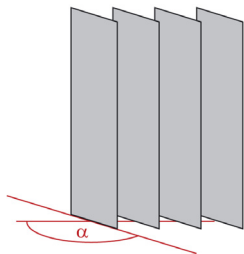

3.7.1 Definition

Parameter	Description	Value
Closing type for channel x	This parameter defines the operating mode used for the affected outputs. An operating mode of the shutter and blind type gives access to additional parameters to control the slat pitch.	Shutter* Shutter and blind

x = 1 to 8

Note: These objects are always visible.

Communication objects:

- 0 - Output 1 - Up / Down (Long key-press) (1 bit - 1.008 DPT_UpDown)
- 27 - Output 2 - Up / Down (Long key-press) (1 bit - 1.008 DPT_UpDown)
- 54 - Output 3 - Up / Down (Long key-press) (1 bit - 1.008 DPT_UpDown)
- 81 - Output 4 - Up / Down (Long key-press) (1 bit - 1.008 DPT_UpDown)
- 108 - Output 5 - Up / Down (Long key-press) (1 bit - 1.008 DPT_UpDown)
- 135 - Output 6 - Up / Down (Long key-press) (1 bit - 1.008 DPT_UpDown)
- 162 - Output 7 - Up / Down (Long key-press) (1 bit - 1.008 DPT_UpDown)
- 189 - Output 8 - Up / Down (Long key-press) (1 bit - 1.008 DPT_UpDown)

- 1 - Output 1 - Step/stop control (Short press) (1 bit - 1.007 DPT_Step)
- 28 - Output 2 - Step/stop control (Short press) (1 bit - 1.007 DPT_Step)
- 55 - Output 3 - Step/stop control (Short press) (1 bit - 1.007 DPT_Step)
- 82 - Output 4 - Step/stop control (Short press) (1 bit - 1.007 DPT_Step)
- 109 - Output 5 - Step/stop control (Short press) (1 bit - 1.007 DPT_Step)
- 136 - Output 6 - Step/stop control (Short press) (1 bit - 1.007 DPT_Step)
- 163 - Output 7 - Step/stop control (Short press) (1 bit - 1.007 DPT_Step)
- 190 - Output 8 - Step/stop control (Short press) (1 bit - 1.007 DPT_Step)

- 2 - Output 1 - Position in % (1 byte - 5.001 DPT_Scaling)
- 29 - Output 2 - Position in % (1 byte - 5.001 DPT_Scaling)
- 56 - Output 3 - Position in % (1 byte - 5.001 DPT_Scaling)
- 83 - Output 4 - Position in % (1 byte - 5.001 DPT_Scaling)
- 110 - Output 5 - Position in % (1 byte - 5.001 DPT_Scaling)
- 137 - Output 6 - Position in % (1 byte - 5.001 DPT_Scaling)
- 164 - Output 7 - Position in % (1 byte - 5.001 DPT_Scaling)
- 191 - Output 8 - Position in % (1 byte - 5.001 DPT_Scaling)

*Note: These objects are only visible if the **Closing type for channel x** parameter has the following value: **Shutter and blind**.*

* Default value

- Communication objects:
- 3 - Output 1 - Slat angle (0-100%) (1 byte - 5.001 DPT_Scaling)
 - 30 - Output 2 - Slat angle (0-100%) (1 byte - 5.001 DPT_Scaling)
 - 57 - Output 3 - Slat angle (0-100%) (1 byte - 5.001 DPT_Scaling)
 - 84 - Output 4 - Slat angle (0-100%) (1 byte - 5.001 DPT_Scaling)
 - 111 - Output 5 - Slat angle (0-100%) (1 byte - 5.001 DPT_Scaling)
 - 138 - Output 6 - Slat angle (0-100%) (1 byte - 5.001 DPT_Scaling)
 - 165 - Output 7 - Slat angle (0-100%) (1 byte - 5.001 DPT_Scaling)
 - 192 - Output 8 - Slat angle (0-100%) (1 byte - 5.001 DPT_Scaling)

Parameter	Description	Value
Complete up movement duration	This parameter defines the time taken, during which the contact must be closed, to reach the upper position.	2 minutes: 0 to 59 min 0 seconds: 0 to 59 s

Note: The smallest executable time is 1 second.

Parameter	Description	Value
Complete down movement duration	This parameter defines the time taken, during which the contact must be closed, to reach the lower position.	2 minutes: 0 to 59 min 0 seconds: 0 to 59 s

Note: The smallest executable time is 1 second.

Parameter	Description	Value
Time delay for direction inversion (ms)	This parameter defines how long the shutter or blind must be stopped before the direction of motion can be reversed. During this time, 2 output contacts are open.	300 ... 600* ... 10000 ms

Parameter	Description	Value
Relay closing time for slat positioning (ms)	This parameter defines how long the contacts must be closed in order to perform an elementary angle step for the slats.	50 ... 150* ... 10000 ms

Note: These objects are only visible if the **Closing type for channel x** parameter has the following value: **Shutter and blind**.

Parameter	Description	Value
Total number of slat angles	This parameter defines the total number of elementary slat steps available for adjusting the slats from the inclined downwards position to be inclined upwards position.	1 ... 12* ... 60

Note: Before setting the **Total number of slat angles** parameter, it is essential to first set the closed contact duration for an elementary slat step.

Note: These objects are only visible if the **Closing type for channel x** parameter has the following value: **Shutter and blind**.

* Default value

Parameter	Description	Value
Secured down	In manual mode, the down contact remains closed only as long as the manual button is being pressed.	Not active* Active

Note: This function is also used in order to give the command to close a swimming pool cover, which for safety reasons also requires a continuous button press.

Parameter	Description	Value
Manual mode active for output X	With this parameter, manual mode can be authorized for the output.	Yes* No

X = 1 to 8

Parameter	Description	Value
Status indication	This parameter allows the display of different status indication objects of the outputs concerned.	Yes* No

Parameter	Description	Value
Status indication position in %	This parameter authorizes the Position in % indication object.	Not active* Active

Communication objects:

- [4 - Output 1 - Position in % indication \(1 byte - 5.001 DPT_Scaling\)](#)
- [31 - Output 2 - Position in % indication \(1 byte - 5.001 DPT_Scaling\)](#)
- [58 - Output 3 - Position in % indication \(1 byte - 5.001 DPT_Scaling\)](#)
- [85 - Output 4 - Position in % indication \(1 byte - 5.001 DPT_Scaling\)](#)
- [112 - Output 5 - Position in % indication \(1 byte - 5.001 DPT_Scaling\)](#)
- [139 - Output 6 - Position in % indication \(1 byte - 5.001 DPT_Scaling\)](#)
- [166 - Output 7 - Position in % indication \(1 byte - 5.001 DPT_Scaling\)](#)
- [193 - Output 8 - Position in % indication \(1 byte - 5.001 DPT_Scaling\)](#)

Parameter	Description	Value
Status indication slat angle in %	This parameter authorizes the Slat angle indication in % object.	Not active* Active

*Note: This parameter is only visible if the **Closing type for channel x** parameter has the following value: **Shutter and blind**.*

Communication objects:

- [5 - Output 1 - Slat angle indication in % \(1 byte - 5.001 DPT_Scaling\)](#)
- [32 - Output 2 - Slat angle indication in % \(1 byte - 5.001 DPT_Scaling\)](#)
- [59 - Output 3 - Slat angle indication in % \(1 byte - 5.001 DPT_Scaling\)](#)
- [86 - Output 4 - Slat angle indication in % \(1 byte - 5.001 DPT_Scaling\)](#)
- [113 - Output 5 - Slat angle indication in % \(1 byte - 5.001 DPT_Scaling\)](#)
- [140 - Output 6 - Slat angle indication in % \(1 byte - 5.001 DPT_Scaling\)](#)
- [167 - Output 7 - Slat angle indication in % \(1 byte - 5.001 DPT_Scaling\)](#)
- [194 - Output 8 - Slat angle indication in % \(1 byte - 5.001 DPT_Scaling\)](#)

* Default value

Parameter	Description	Value
Status indication upper position reached	This parameter authorizes the Upper position reached object.	Not active* Active

Communication objects:

- [6 - Output 1 - Upper position reached](#) (1 bit - 1.002 DPT_Bool)
- [33 - Output 2 - Upper position reached](#) (1 bit - 1.002 DPT_Bool)
- [60 - Output 3 - Upper position reached](#) (1 bit - 1.002 DPT_Bool)
- [87 - Output 4 - Upper position reached](#) (1 bit - 1.002 DPT_Bool)
- [114 - Output 5 - Upper position reached](#) (1 bit - 1.002 DPT_Bool)
- [141 - Output 6 - Upper position reached](#) (1 bit - 1.002 DPT_Bool)
- [168 - Output 7 - Upper position reached](#) (1 bit - 1.002 DPT_Bool)
- [195 - Output 8 - Upper position reached](#) (1 bit - 1.002 DPT_Bool)

Parameter	Description	Value
Status indication lower position reached	This parameter authorizes the Lower position reached object.	Not active* Active

Communication objects:

- [7 - Output 1 - Lower position reached](#) (1 bit - 1.002 DPT_Bool)
- [34 - Output 2 - Lower position reached](#) (1 bit - 1.002 DPT_Bool)
- [61 - Output 3 - Lower position reached](#) (1 bit - 1.002 DPT_Bool)
- [88 - Output 4 - Lower position reached](#) (1 bit - 1.002 DPT_Bool)
- [115 - Output 5 - Lower position reached](#) (1 bit - 1.002 DPT_Bool)
- [142 - Output 6 - Lower position reached](#) (1 bit - 1.002 DPT_Bool)
- [169 - Output 7 - Lower position reached](#) (1 bit - 1.002 DPT_Bool)
- [196 - Output 8 - Lower position reached](#) (1 bit - 1.002 DPT_Bool)

Parameter	Description	Value
Scene	The Scenes tab and the associated parameters and objects are: Hidden. Displayed.	Not active* Active

Communication objects:

- [8 - Output 1 - Scene](#) (1 byte - 17.001 DPT_SceneNumber)
- [35 - Output 2 - Scene](#) (1 byte - 17.001 DPT_SceneNumber)
- [62 - Output 3 - Scene](#) (1 byte - 17.001 DPT_SceneNumber)
- [89 - Output 4 - Scene](#) (1 byte - 17.001 DPT_SceneNumber)
- [116 - Output 5 - Scene](#) (1 byte - 17.001 DPT_SceneNumber)
- [143 - Output 6 - Scene](#) (1 byte - 17.001 DPT_SceneNumber)
- [170 - Output 7 - Scene](#) (1 byte - 17.001 DPT_SceneNumber)
- [197 - Output 8 - Scene](#) (1 byte - 17.001 DPT_SceneNumber)

For configuration see section: [Scene](#).

* Default value

Parameter	Description	Value
Lock-up	The Lock-up tab and the associated parameters and objects are: Hidden. Displayed for 1 lock-up object. Displayed for 2 lock-up objects.	Not active* 1 lock-up object 2 lock-up objects

Lock-up 1 communication objects

- 13 - Output 1 - Lock-up 1 (1 bit - 1.003 DPT_Enable)
- 40 - Output 2 - Lock-up 1 (1 bit - 1.003 DPT_Enable)
- 67 - Output 3 - Lock-up 1 (1 bit - 1.003 DPT_Enable)
- 94 - Output 4 - Lock-up 1 (1 bit - 1.003 DPT_Enable)
- 121 - Output 5 - Lock-up 1 (1 bit - 1.003 DPT_Enable)
- 148 - Output 6 - Lock-up 1 (1 bit - 1.003 DPT_Enable)
- 175 - Output 7 - Lock-up 1 (1 bit - 1.003 DPT_Enable)
- 203 - Output 8 - Lock-up 1 (1 bit - 1.003 DPT_Enable)

Lock-up 2 communication objects

- 14 - Output 1 - Lock-up 2 (1 bit - 1.003 DPT_Enable)
- 41 - Output 2 - Lock-up 2 (1 bit - 1.003 DPT_Enable)
- 68 - Output 3 - Lock-up 2 (1 bit - 1.003 DPT_Enable)
- 95 - Output 4 - Lock-up 2 (1 bit - 1.003 DPT_Enable)
- 122 - Output 5 - Lock-up 2 (1 bit - 1.003 DPT_Enable)
- 149 - Output 6 - Lock-up 2 (1 bit - 1.003 DPT_Enable)
- 176 - Output 7 - Lock-up 2 (1 bit - 1.003 DPT_Enable)
- 204 - Output 8 - Lock-up 2 (1 bit - 1.003 DPT_Enable)

For configuration see section: [Lock-up](#).

Parameter	Description	Value
Preset	The Preset tab and the associated parameters and objects are: Hidden. Displayed for 1 Preset object. Displayed for 2 Preset objects.	Not active* Active with preset 1-level object Active with preset 2-level objects

Note: When the value of this parameter changes, the associated parameters and group addresses are deleted.

* Default value

Preset 1 communication
Objets

- 9 - Output 1 - Preset 1 (1 bit - 1.022 DPT_Scene_AB)
- 36 - Output 2 - Preset 1 (1 bit - 1.022 DPT_Scene_AB)
- 63 - Output 3 - Preset 1 (1 bit - 1.022 DPT_Scene_AB)
- 90 - Output 4 - Preset 1 (1 bit - 1.022 DPT_Scene_AB)
- 117 - Output 5 - Preset 1 (1 bit - 1.022 DPT_Scene_AB)
- 144 - Output 6 - Preset 1 (1 bit - 1.022 DPT_Scene_AB)
- 171 - Output 7 - Preset 1 (1 bit - 1.022 DPT_Scene_AB)
- 198 - Output 8 - Preset 1 (1 bit - 1.022 DPT_Scene_AB)

Preset 2 communication
Objets

- 10 - Output 1 - Preset 2 1 bit - 1.022 DPT_Scene_AB)
- 37 - Output 2 - Preset 2 (1 bit- 1.022 DPT_Scene_AB)
- 64 - Output 3 - Preset 2 (1 bit- 1.022 DPT_Scene_AB)
- 91 - Output 4 - Preset 2 (1 bit - 1.022 DPT_Scene_AB)
- 118 - Output 5 - Preset 2 (1 bit - 1.022 DPT_Scene_AB)
- 145 - Output 6 - Preset 2 (1 bit - 1.022 DPT_Scene_AB)
- 172 - Output 7 - Preset 2 (1 bit - 1.022 DPT_Scene_AB)
- 199 - Output 8 - Preset 2 (1 bit- 1.022 DPT_Scene_AB)

For configuration see section: [Preset](#).

Parameter	Description	Value
Priority	The Priority tab and the associated parameters and objects are: Hidden. Displayed.	Not active* Active

The device responds to telegrams received via the **Priority** object, as given in the following table:

Telegram received by the priority operation object		Status of the outputs
Bit 1	Bit 2	
0	0	End of the priority
0	1	End of the priority
1	0	Priority OFF
1	1	Priority ON

Communication objects:

- 16 - Output 1 - Priority (2 bit - 2.002 DPT_Bool_Control)
- 43 - Output 2 - Priority (2 bit - 2.002 DPT_Bool_Control)
- 70 - Output 3 - Priority (2 bit - 2.002 DPT_Bool_Control)
- 97 - Output 4 - Priority (2 bit - 2.002 DPT_Bool_Control)
- 124 - Output 5 - Priority (2 bit - 2.002 DPT_Bool_Control)
- 151 - Output 6 - Priority (2 bit - 2.002 DPT_Bool_Control)
- 178 - Output 7 - Priority (2 bit - 2.002 DPT_Bool_Control)
- 206 - Output 8 - Priority (2 bit - 2.002 DPT_Bool_Control)

For configuration see section: [Priority](#).

* Default value

Parameter	Description	Value
Alarm	The Alarm tab and the associated parameters and objects are: Hidden. Displayed for 1 alarm object Displayed for 2 alarm objects Displayed for 3 alarm objects	Not active* 1 alarm object 2 alarm objects 3 alarm objects

Communication objects:

- [18 - Output 1 - Alarm 1](#) (1 bit - 1.005 DPT_Alarm)
- [45 - Output 2 - Alarm 1](#) (1 bit - 1.005 DPT_Alarm)
- [72 - Output 3 - Alarm 1](#) (1 bit - 1.005 DPT_Alarm)
- [99 - Output 4 - Alarm 1](#) (1 bit - 1.005 DPT_Alarm)
- [126 - Output 5 - Alarm 1](#) (1 bit - 1.005 DPT_Alarm)
- [153 - Output 6 - Alarm 1](#) (1 bit - 1.005 DPT_Alarm)
- [180 - Output 7 - Alarm 1](#) (1 bit - 1.005 DPT_Alarm)
- [207 - Output 8 - Alarm 1](#) (1 bit - 1.005 DPT_Alarm)

Communication objects:

- [19 - Output 1 - Alarm 2](#) (1 bit - 1.005 DPT_Alarm)
- [46 - Output 2 - Alarm 2](#) (1 bit - 1.005 DPT_Alarm)
- [73 - Output 3 - Alarm 2](#) (1 bit - 1.005 DPT_Alarm)
- [100 - Output 4 - Alarm 2](#) (1 bit - 1.005 DPT_Alarm)
- [127 - Output 5 - Alarm 2](#) (1 bit - 1.005 DPT_Alarm)
- [154 - Output 6 - Alarm 2](#) (1 bit - 1.005 DPT_Alarm)
- [181 - Output 7 - Alarm 2](#) (1 bit - 1.005 DPT_Alarm)
- [208 - Output 8 - Alarm 2](#) (1 bit - 1.005 DPT_Alarm)

Communication objects:

- [20 - Output 1 - Alarm 3](#) (1 bit - 1.005 DPT_Alarm)
- [47 - Output 2 - Alarm 3](#) (1 bit - 1.005 DPT_Alarm)
- [74 - Output 3 - Alarm 3](#) (1 bit - 1.005 DPT_Alarm)
- [101 - Output 4 - Alarm 3](#) (1 bit - 1.005 DPT_Alarm)
- [128 - Output 5 - Alarm 3](#) (1 bit - 1.005 DPT_Alarm)
- [155 - Output 6 - Alarm 3](#) (1 bit - 1.005 DPT_Alarm)
- [182 - Output 7 - Alarm 3](#) (1 bit - 1.005 DPT_Alarm)
- [209 - Output 8 - Alarm 3](#) (1 bit - 1.005 DPT_Alarm)

For configuration see section: [Alarm](#).

* Default value

Parameter	Description	Value
Sun protection	The Reactivate sun protection tab and the associated parameters and objects are: Hidden. Displayed.	Not active* Active

Communication objects:

- 22 - Output 1 - Sun protection position %** (1 byte - 5.001 DPT_Scaling)
- 49 - Output 2 - Sun protection position %** (1 byte - 5.001 DPT_Scaling)
- 76 - Output 3 - Sun protection position %** (1 byte - 5.001 DPT_Scaling)
- 103 - Output 4 - Sun protection position %** (1 byte - 5.001 DPT_Scaling)
- 130 - Output 5 - Sun protection position %** (1 byte - 5.001 DPT_Scaling)
- 157 - Output 6 - Sun protection position %** (1 byte - 5.001 DPT_Scaling)
- 184 - Output 7 - Sun protection position %** (1 byte - 5.001 DPT_Scaling)
- 211 - Output 8 - Sun protection position %** (1 byte - 5.001 DPT_Scaling)

Communication objects:

- 23 - Output 1 - Slat angle (0-100%)** (1 byte - 5.001 DPT_Scaling)
- 50 - Output 2 - Slat angle (0-100%)** (1 byte - 5.001 DPT_Scaling)
- 77 - Output 3 - Slat angle (0-100%)** (1 byte - 5.001 DPT_Scaling)
- 104 - Output 4 - Slat angle (0-100%)** (1 byte - 5.001 DPT_Scaling)
- 131 - Output 5 - Slat angle (0-100%)** (1 byte - 5.001 DPT_Scaling)
- 158 - Output 6 - Slat angle (0-100%)** (1 byte - 5.001 DPT_Scaling)
- 185 - Output 7 - Slat angle (0-100%)** (1 byte - 5.001 DPT_Scaling)
- 212 - Output 8 - Slat angle (0-100%)** (1 byte - 5.001 DPT_Scaling)

For configuration see section: [Sun protection](#).

* Default value

3.7.2 Scene

Device: 1.1.3 8-fold blind actuator 6A 230V AC

Outputs 1-8: Function selection - O1-8: Manual mode - O1-8: Status indications Output 1: Function selection - O1: Scenes Output 2: Function selection Output 3: Function selection Output 4: Function selection Output 5: Function selection Output 6: Function selection Output 7: Function selection Output 8: Function selection Information	Number of scenes used: 8 Scenes memorisation by long key press: Active Scenes memorisation acknowledgment (Output status inversed for 3s): Not active Position for scene 1: Not active Position for scene 2: Not active Position for scene 3: Not active Position for scene 4: Not active Position for scene 5: Not active Position for scene 6: Not active Position for scene 7: Not active Position for scene 8: Not active
---	---

Parameter	Description	Value
Number of scenes used	This parameter determines the number of scenes used.	8* - 16 - 24 - 32 - 48 - 64

Note: If the Scene number received on the Scene object is greater than the maximum number of scenes, the status of the output remains unchanged.

Parameter	Description	Value
Scenes memorisation by very long key press	This parameter allows learning and storing of a scene by, for example, a long press (> 5 seconds) of the corresponding push button.	Not active Active*

Learning and storing scenes

This process is used to change and store a scene. For example, by locally pressing the key in the room or by emission of the values from a visualization.

To access and store scenes, the following values must be sent:

Scene number	Access scene (Object value: 1 byte)	Store scene (Object value: 1 byte)
1 - 64	= Scene number - 1	= Scene number + 128
Example		
1	0	128
2	1	129
3	2	130
...	...	
64	63	191

* Default value

Here is the scene memorisation for local switches, for example.

- Activate scene by briefly pressing the transmitter that starts it.
- The outputs (lights, shutters, etc.) are set in the desired state using the usual local control devices (buttons, remote control, etc.).
- Memorise the status of the outputs with a press greater than 5 seconds long on the transmitter that starts the scene. The memorisation can be displayed by short-term activation of the outputs.

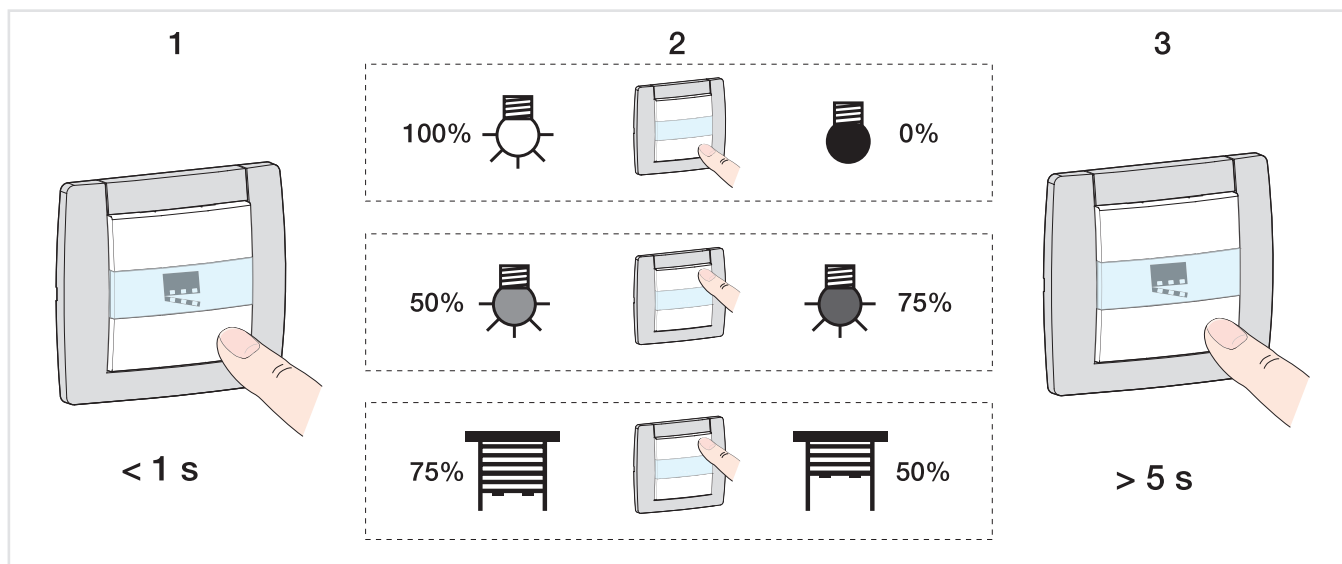

Parameter	Description	Value
Scenes memorisation acknowledgment	Memorisation of a scene is: Not acknowledged. Acknowledged by the output by a 3 second long inversion of the output status.	Not active* Active

Parameter	Description	Value
Position for scene X	On activation of Scene X, the output is: Not changed. Closes the Up contact. Closes the down contact. Runs to a specific position. Reactivate the sun protection function. Lock-up the Sun protection function.	Not active* Up Down Specific position Sun protection reactivation Deactivation sun protection

X = 1 to 64

Note: Each output has up to 64 scenes available, in accordance with the **Number of scenes used** parameter.

Note: The Sun protection function of the selected output must be configured. If this is not the case, the status remains unchanged. If this is not the case, the status remains unchanged.

Note: Local storage of the scene is not recorded if the **Position for scene X** parameter is not active.

* Default value

Parameter	Description	Value
Position (0-100%)	This parameter defines the position to run the shutter or blind to for scene X.	0 ... 5* ... 100

Note: This parameter is only visible if the **Position for scene X** parameter has the following value: **Specific position**.

Parameter	Description	Value
Slat angle (0-100%)	This parameter defines the slat position of the blind to be used for scene X.	0 ... 5* ... 100

Note: This parameter is only visible if the **Position for scene X** parameter has the value **Specific position** and if the **Closing type for channel** parameter has the value **blind**.

3.7.3 Lock-up

Device: 1.1.3 8-fold blind actuator 6A 230V AC

Outputs 1-8: Function selection

- O1-8: Manual mode
- O1-8: Status indications

Output 1: Function selection

- O1: Lock-up

Output 2: Function selection

Output 3: Function selection

Output 4: Function selection

Output 5: Function selection

Output 6: Function selection

Output 7: Function selection

Output 8: Function selection

Information

Lock-up type:

Lock-up duration:

Polarity of lock-up object 1:

Polarity of lock-up object 2:

Priority between lock-up 1 and lock-up 2:

Position during lock-up 1:

Position during lock-up 2:

Position after lock-up function 1:

Position after lock-up function 2:

Activation of lock-up status object:

Polarity:

Emission:

Hours (h):

Minutes (min):

Seconds (s):

The Lock-up function is used to lock the output in a predefined state.

Priority: Manual mode > Priority > **Lock-up** > Basic function.

The Lock-up prevents actuation until an unlock command has been received.

The Lock-up duration can be set.

* Default value

Parameter	Description	Value
Lock-up type	<p>The Lock-up acts:</p> <p>Directly on the switch actuator. As long as the Lock-up is active, the output can only be controlled by higher priority commands.</p> <p>On selected communication objects. As long as the Lock-up is active, the output can only be controlled via specific selectable objects.</p>	<p>Output lock-up*</p> <p>Object lock-up</p>

Parameter	Description	Value
Lock-up duration	<p>The duration of the Lock-up is</p> <p>Not time limited, the lock-up is only authorized by means of a telegram on Lock-up 1 object.</p> <p>Is active for a limited time, the control of the output is authorized after expiry of this time.</p>	<p>Permanently*</p> <p>Time limited</p>

Parameter	Description	Value
Hours (h)	This parameter determines the activation time of the Lock-up.	0 hours: 0 to 23 h
Minutes (min)		15 minutes: 0 to 59 min
Seconds (s)		0 seconds: 0 to 59 s

Note: The smallest executable time is 1 second.

Note: This parameter is only visible if the **Lock-up duration** parameter has the following value: **Time limited**.

Parameter	Description	Value
Polarity of lock-up object 1	<p>On receipt of a value on the Lock-up 1 object, the lock-up:</p> <p>Is activated on object value 1. Is deactivated on object value 0.</p> <p>Is activated on object value 0. Is deactivated on object value 1.</p>	<p>0 = Lock-up deactivated, 1 = Lock-up activated*</p> <p>0 = Lock-up activated, 1 = Lock-up deactivated</p>

Note: The parameters and objects are identical for Lock-up 2 ; Only the terms will be adjusted.

Parameter	Description	Value
Priority between lock-up 1 and lock-up 2	<p>The priority between lock-up 1 and lock-up 2 is set as follows:</p> <p>Lock-up 1 has priority over lock-up 2.</p> <p>Lock-up 2 has priority over lock-up 1.</p> <p>Lock-up 1 and lock-up 2 have the same priority.</p>	<p>Lock-up 1 > Lock-up 2*</p> <p>Lock-up 1 < Lock-up 2</p> <p>Lock-up 1 = Lock-up 2</p>

Note: This parameter is only visible if the **Lock-up** parameter has the following value: **Active with 2 lock-up objects**.

Note: The priority of the Lock-up always functions in the same way, independently of the lock-up type (Output lock-up or object lock-up).

* Default value

Operating principle of the priorities:
If Lock-up 1 > Lock-up 2

Active lock-up	Activation order of Lock-up 1	Activation order of Lock-up 2
None	Lock-up 1 is activated	Lock-up 2 is activated
Lock-up 1	Lock-up 1 remains active	Despite the activation order of Lock-up 2, Lock-up 1 remains activated
Lock-up 2	Lock-up 1 is activated	Lock-up 2 remains active

If Lock-up 1 = Lock-up 2

Active lock-up	Activation order of Lock-up 1	Activation order of Lock-up 2
None	Lock-up 1 is activated	Lock-up 2 is activated
Lock-up 1	Lock-up 1 remains active	Lock-up 2 is activated
Lock-up 2	Lock-up 1 is activated	Lock-up 2 remains active

If Lock-up 1 < Lock-up 2

Active lock-up	Activation order of Lock-up 1	Activation order of Lock-up 2
None	Lock-up 1 is activated	Lock-up 2 is activated
Lock-up 1	Lock-up 1 remains active	Lock-up 2 is activated
Lock-up 2	Despite the activation order of Lock-up 1, Lock-up 2 remains activated	Lock-up 2 remains active

Parameter	Description	Value
Position during lock-up 1	During Lock-up 1, the shutter/blind output: Not changed. Closes the Up contact. Closes the down contact. Opens the 2 contacts. Runs to a specific position.	Maintain status* Up Down Stop Specific position

Note: The parameters and objects are identical for Lock-up 2 ; Only the terms will be adjusted.

Parameter	Description	Value
Position (0-100%)	This parameter defines the position to run the shutter or blind to.	0 ... 5* ... 100

Note: This parameter is only visible if the **Position during lock-up 1]** parameter has the following value: **Specific position**.

Parameter	Description	Value
Slat angle (0-100%)	This parameter defines the slat position to use for the blind.	0 ... 5* ... 100

Note: This parameter is only visible if the **Position during lock-up 1** parameter has the value **Specific position** and if the **Closing type for channel** parameter has the value **blind**.

* Default value

Lock-up 1 authorizes object:

The parameters listed below allow the selection of the objects for controlling the output via the nevertheless active Lock-up.

*Note: These parameters are only visible if the **Lock-up type** parameter has the following value: **Object lock-up**.*

Parameter	Objects concerned	Value
Up/down	Up/Down (long key-press)	Yes No*
Slat angle/stop	Step/stop (short press)	Yes No*
Scene	Scene	Yes No*
Position in %	Position in %	Yes No*
Slat angle in %	Slat angle in %	Yes No*
Sun protection position in %	Sun protection position in %	Yes No*
Sun protection slat angle in %	Slat angle (0-100%)	Yes No*
Preset 1	Preset 1	Yes No*
Preset 2	Preset 2	Yes No*

Note: The parameters and objects are identical for Lock-up 2 ; Only the terms will be adjusted.

Parameter	Description	Value
Position after lock-up function 1	<p>After lock-up 1, the shutter/blind output: Not changed.</p> <p>Closes the Up contact.</p> <p>Closes the down contact.</p> <p>Runs to a specific position.</p> <p>Returns to the position before lock-up 1.</p> <p>Runs to the position which would be active according to other communication objects if lock-up 1 had not taken place.</p>	<p>Maintain status*</p> <p>Up</p> <p>Down</p> <p>Specific position</p> <p>Status before lock-up</p> <p>Theoretical status without lock-up function 1</p>

*Note: On **Theoretical status without lock-up function 1**, the Up/Down and slat step commands are not saved.*

Note: The parameters and objects are identical for Lock-up 2 ; Only the terms will be adjusted.

Parameter	Description	Value
Position (0-100%)	This parameter defines the position to run the shutter or blind to.	0 ... 5* ... 100

*Note: This parameter is only visible if the **Position after lock-up function 1** parameter has the following value: **Specific position**.*

* Default value

Parameter	Description	Value
Slat angle (0-100%)	This parameter defines the slat position to use for the blind.	0 ... 5* ... 100

*Note: This parameter is only visible if the **Position after lock-up function 1** parameter has the value **Specific position** and if the **Closing type for channel** parameter has the value **blind**.*

Parameter	Description	Value
Activation of lock-up status object	The Status indication lock-up communication object is hidden.	Not active*
	The Status indication lock-up communication object is displayed.	Active

Communication objects:

- [15 - Output 1 - Status indication lock-up \(1 bit - 1.011 DPT_State\)](#)
- [42 - Output 2 - Status indication lock-up \(1 bit - 1.011 DPT_State\)](#)
- [69 - Output 3 - Status indication lock-up \(1 bit - 1.011 DPT_State\)](#)
- [96 - Output 4 - Status indication lock-up \(1 bit - 1.011 DPT_State\)](#)
- [123 - Output 5 - Status indication lock-up \(1 bit - 1.011 DPT_State\)](#)
- [150 - Output 6 - Status indication lock-up \(1 bit - 1.011 DPT_State\)](#)
- [177 - Output 7 - Status indication lock-up \(1 bit - 1.011 DPT_State\)](#)
- [205 - Output 8 - Status indication lock-up \(1 bit - 1.011 DPT_State\)](#)

Parameter	Description	Value
Polarity	The Status indication Lock-up communication object sends: 0 on deactivation of the lock-up. 1 on activation of the lock-up. 0 on activation of the lock-up. 1 on deactivation of the lock-up.	0 = Lock-up deactivated, 1 = Lock-up activated* 0 = Lock-up activated, 1 = Lock-up deactivated

Parameter	Description	Value
Emission	The Status indication lock-up communication object is sent: On activation and deactivation of the lock-up. Periodically after a configurable time. On activation and deactivation of the lock-up and periodically after a configurable time.	On status change* Periodically On status change and periodically

*Note: This parameter is only visible if the **Activation of Lock-up status object** parameter has the following value: **Active**.*

Parameter	Description	Value
Hours (h)	This parameter determines the time between the individual transmissions of the Status indication lock-up object.	0 hours: 0 to 23 h
Minutes (min)		10 minutes: 0 to 59 min
Seconds (s)		0 seconds: 0 to 59 s

Note: The smallest executable time is 1 second.

*Note: This parameter is only visible if the **Emission** parameter has the following value: **Periodically** or **On status change and periodically**.*

* Default value

3.7.4 Preset

Device: 1.1.3 8-fold blind actuator 6A 230V AC

Outputs 1-8: Function selection - O1-8: Manual mode - O1-8: Status indications Output 1: Function selection - O1: Preset Output 2: Function selection Output 3: Function selection Output 4: Function selection Output 5: Function selection Output 6: Function selection Output 7: Function selection Output 8: Function selection Information	Preset authorization objects Active Value of authorization preset 1 at initialization Value before initialization Value of authorization preset 2 at initialization Value before initialization Polarity of Preset 1 authorization object 0 = Locked-up , 1 = Authorized Polarity of Preset 2 authorization object 0 = Locked-up , 1 = Authorized Position in % if preset 1 = 0 Scene number Scene for preset 1 = 0 1 Position in % if preset 1 = 1 Specific position Position (0-100%) 100 Slat angle (0-100%) 100 Position in % if preset 2 = 0 Maintain status Position in % if preset 2 = 1 Maintain status
---	---

The Preset function is used to switch an output into various predefined states. The Preset function is activated via an object in 1-bit format.

Principle of Preset authorization:

The parameters are set as follows:

- Polarity of Preset 1 authorization object: 0 = Locked-up, 1 = Authorized.
- Polarity of Preset 2 authorization object: 0 = Locked-up, 1 = Authorized.
- Position in % if preset 1 = 0: Shutter DOWN.
- Position in % if preset 1 = 1: Shutter UP.
- Position in % if preset 2 = 0: Scene 1.
- Position in % if preset 2 = 1: Scene 2.

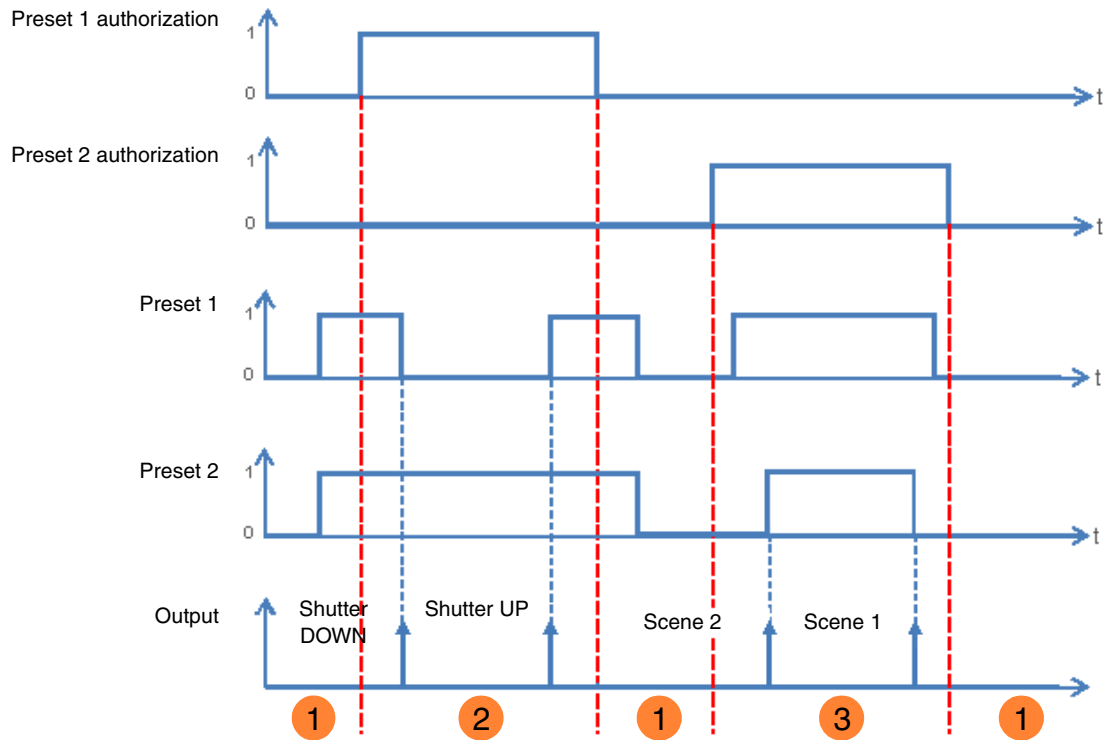

- ❶ The preset inputs have no influence on the output.
- ❷ The commands from Preset 1 are executed.
- ❸ The commands from Preset 2 are executed.

Note: The commands from the Preset will not be executed immediately after authorization, but only when the value of the Preset changes.

Parameter	Description	Value
Preset authorization objects	The Preset 1 authorization communication object and the related parameters are: Hidden. Displayed. This object allows the authorization or lock-up of the Preset 1 function via a KNX telegram.	Not active* Active

*Note: The number of available Preset objects is dependent on the **Preset** parameter. A maximum of two of these objects can be available.*

- Communication objects:
- [11 - Output 1 - Preset 1 authorization \(1 bit - 1.003 DPT_Enable\)](#)
 - [38 - Output 2 - Preset 1 authorization \(1 bit - 1.003 DPT_Enable\)](#)
 - [65 - Output 3 - Preset 1 authorization \(1 bit - 1.003 DPT_Enable\)](#)
 - [92 - Output 4 - Preset 1 authorization \(1 bit - 1.003 DPT_Enable\)](#)
 - [119 - Output 5 - Preset 1 authorization \(1 bit - 1.003 DPT_Enable\)](#)
 - [146 - Output 6 - Preset 1 authorization \(1 bit - 1.003 DPT_Enable\)](#)
 - [173 - Output 7 - Preset 1 authorization \(1 bit - 1.003 DPT_Enable\)](#)
 - [200 - Output 8 - Preset 1 authorization \(1 bit - 1.003 DPT_Enable\)](#)

* Default value

- Communication objects:
- 12 - Output 1 - Preset 2 authorization** (1 bit - 1.003 DPT_Enable)
 - 39 - Output 2 - Preset 2 authorization** (1 bit - 1.003 DPT_Enable)
 - 66 - Output 3 - Preset 2 authorization** (1 bit - 1.003 DPT_Enable)
 - 93 - Output 4 - Preset 2 authorization** (1 bit - 1.003 DPT_Enable)
 - 120 - Output 5 - Preset 2 authorization** (1 bit - 1.003 DPT_Enable)
 - 147 - Output 6 - Preset 2 authorization** (1 bit - 1.003 DPT_Enable)
 - 174 - Output 7 - Preset 2 authorization** (1 bit - 1.003 DPT_Enable)
 - 201 - Output 8 - Preset 2 authorization** (1 bit - 1.003 DPT_Enable)

Note: The parameters and objects are identical for Preset 2 ; Only the terms will be adjusted.

Parameter	Description	Value
Value of authorization preset 1 at initialization	On initialization of the device after a download or after return of the bus power, the value of the Preset 1 authorization object is: Set to 0. Set to 1. Set according to the value of the logic input before the initialization occurred.	0 1 Value before initialization*

Note: This parameter is only visible if the **Preset authorization objects** parameter has the following value: **Active**.

Parameter	Description	Value
Polarity of Preset 1 authorization object	On receipt of a value on the Preset 1 authorization object, Preset 1 : Locked-up on object value 1. Locked-up on object value 0.	0 = Locked-up, 1 = Authorized* 0 = Authorized, 1 = Locked-up

Note: This parameter is only visible if the **Preset authorization objects** parameter has the following value: **Active**.

Parameter	Description	Value
Position in % if preset 1 = 0	During Preset 1 = 0 , the shutter/blind output: Not changed. Closes the Up contact. Closes the down contact. Opens the 2 contacts. Runs to a specific position. Runs to a position set in a scene. Reactivate the sun protection function. Lock-up the Sun protection function. Runs back to the position for Preset 1 = 1	Maintain status* Up Down Stop Specific position Scene number Activate sun protection Deactivation sun protection Status before preset 1 = 1

* Default value

Parameter	Description	Value
Position (0-100%)	This parameter defines the position to run the shutter or blind to.	0* ... 100

Note: This parameter is only visible if the **Position in % if preset 1 = 0** parameter has the following value: **Specific position**.

Parameter	Description	Value
Slat angle (0-100%)	This parameter defines the slat position to use for the blind.	0* ... 100

Note: This parameter is only visible if the **Position in % if preset 1 = 0** parameter has the value **Specific position** and if the **Closing type for channel** parameter has the value **blind**.

Parameter	Description	Value
Scene number for preset 1 = 0	This parameter determines the value of the scene if: The Preset 1 object has value 0. The Status if preset 1 object = 0 object has the scene value.	Scene 1 ... 64 Default value: 1

Parameter	Description	Value
Position in % if preset 1 = 1	During Preset 1 = 0 , the shutter/blind output Not changed. Closes the Up contact. Closes the down contact. Opens the 2 contacts. Runs to a specific position. Runs to a position set in a scene. Reactivate the sun protection function. Lock-up the Sun protection function. Runs back to the position for Preset 1 = 0	Maintain status* Up Down Stop Specific position Scene number Activate sun protection Deactivation sun protection Status before preset 1 = 0

Parameter	Description	Value
Position (0-100%)	This parameter defines the position to run the shutter or blind to.	0* ... 100

Note: This parameter is only visible if the **Position in % if preset 1 = 1** parameter has the following value: **Specific position**.

Parameter	Description	Value
Slat angle (0-100%)	This parameter defines the slat position to use for the blind.	0* ... 100

Note: This parameter is only visible if the **Position in % if preset 1 = 1** parameter has the value **Specific position** and if the **Closing type for channel** parameter has the value **blind**.

* Default value

Parameter	Description	Value
Scene number for preset 1 = 1	This parameter determines the value of the scene if: The Preset 1 object has value 1. The Status if preset 1 object = 1 object has the scene value.	Scene 1 ... 64 Default value: 2

3.7.5 Priority

Device: 1.1.3 8-fold blind actuator 6A 230V AC

<ul style="list-style-type: none"> Outputs 1-8: Function selection - O1-8: Manual mode - O1-8: Status indications Output 1: Function selection - O1: Priority Output 2: Function selection Output 3: Function selection Output 4: Function selection Output 5: Function selection Output 6: Function selection Output 7: Function selection Output 8: Function selection Information 	<p>Activation of priority status object <input type="text" value="Active"/></p> <p>Polarity <input type="text" value="0 = Not forced, 1 = Forced"/></p> <p>Emission <input type="text" value="On status change and periodically"/></p> <p>Hours (h) <input type="text" value="0"/></p> <p>Minutes (min) <input type="text" value="10"/></p> <p>Seconds (s) <input type="text" value="0"/></p> <p>Position after priority <input type="text" value="Maintain status"/></p>
--	---

The Priority is used to force the output into a predefined state.

Priority: Manual mode > **Priority** > Lock-up > Basic function.

No other command is taken into account when the Priority is active. Only by ending the Priority are other commands again permitted.

Parameter	Description	Value
Activation of priority status object	The Status indication priority communication object and related parameters are hidden.	Not active*
	The Status indication priority communication object and related parameters are displayed.	Active

Communication objects:

- 17 - Output 1 - Status indication priority** (1 bit - 1.011 DPT_State)
- 44 - Output 2 - Status indication priority** (1 bit - 1.011 DPT_State)
- 71 - Output 3 - Status indication priority** (1 bit - 1.011 DPT_State)
- 98 - Output 4 - Status indication priority** (1 bit - 1.011 DPT_State)
- 125 - Output 5 - Status indication priority** (1 bit - 1.011 DPT_State)
- 152 - Output 6 - Status indication priority** (1 bit - 1.011 DPT_State)
- 179 - Output 7 - Status indication priority** (1 bit - 1.011 DPT_State)
- 206 - Output 8 - Status indication priority** (1 bit - 1.011 DPT_State)

Parameter	Description	Value
Polarity	The Status indication priority communication object sends: 0 on deactivation of the Priority. 1 on activation of the Priority. 0 on activation of the Priority. 1 on deactivation of the Priority.	0 = Not forced, 1 = Forced* 0 = Forced, 1 = Not forced

Note: This parameter is only visible if the **Activation of priority status object** parameter has the following value: **Active**.

* Default value

Parameter	Description	Value
Emission	The Status indication priority communication object is sent: On activation and deactivation of the Priority. Periodically after a configurable time. On activation and deactivation of the Priority and periodically after a configurable time.	On status change* Periodically On status change and periodically

Note: This parameter is only visible if the **Activation of priority status object** parameter has the following value: **Active**.

Parameter	Description	Value
Hours (h)	This parameter determines the time between the individual transmissions of the Status indication priority object.	0 hours: 0 to 23 h
Minutes (min)		10 minutes: 0 to 59 min
Seconds (s)		0 seconds: 0 to 59 s

Note: The smallest executable time is 1 second.

Note: This parameter is only visible if the **Emission** parameter has the following value: **Periodically** or **On status change and periodically**.

Parameter	Description	Value
Position after priority	After Priority, the shutter/blind output: Not changed. Closes the Up contact. Closes the down contact. Runs to a specific position. Returns to the Position before priority. Runs to the position which would be active according to other communication objects if the priority had not taken place.	Maintain status* Up Down Specific position Status before priority Theoretical status without priority

Parameter	Description	Value
Position (0-100%)	This parameter defines the position to run the shutter or blind to on disappearing of the priority.	0 ... 5* ... 100

Note: This parameter is only visible if the **Position after priority** parameter has the following value: **Specific position**.

Parameter	Description	Value
Slat angle (0-100%)	This parameter defines the slat position to apply to the blind on disappearing of the priority.	0 ... 5* ... 100

Note: This parameter is only visible if the **Position after priority** parameter has the value **Specific position** and if the **Closing type** for channel parameter has the value **blind**.

* Default value

3.7.6 Alarm

Device: 1.1.3 8-fold blind actuator 6A 230V AC

Outputs 1-8: Function selection

- O1-8: Manual mode
- O1-8: Status indications

Output 1: Function selection

- O1: Alarm

Output 2: Function selection

Output 3: Function selection

Output 4: Function selection

Output 5: Function selection

Output 6: Function selection

Output 7: Function selection

Output 8: Function selection

Information

Alarm 1

Position on alarm 1

Position after alarm 1

Alarm 2

Position on alarm 2

Position after alarm 2

Alarm 3

Position on alarm 3

Position after alarm 3

Priority between alarm 1, 2 and 3

Alarm status object

Polarity

Emission

Alarm monitoring period

Hours (h)

Minutes (min)

Seconds (s)

3.7.6.1 Alarm 1 to 3

Parameter	Description	Value
Alarm X	This parameter defines whether the Alarm function is active permanently or time-limited.	Permanently* Time limited

Permanently: The function is active until receipt of an alarm cancellation.

Time limited: The function is activated for a given period. At the end of this delay, the alarm is no longer active. To switch the Alarm function on again for a given period, a new activation of the function is required.

Parameter	Description	Value
Hours (h)	This parameter determines the activation time of the Alarm function.	0 hours: 0 to 23 h
Minutes (min)		30 minutes: 0 to 59 min
Seconds (s)		0 seconds: 0 to 59 s

Note: The smallest executable time is 1 second.

*Note: This parameter is only visible if the **Alarm X** parameter has the following value: **Time limited**.*

* Default value

Parameter	Description	Value
Position on alarm X	On Alarm X, the shutter/blind output: Not changed. Closes the Up contact. Closes the down contact. Opens the 2 contacts. Runs to a specific position. Runs to a position set in a scene.	Maintain status* Up Down Stop Specific position Scene number

X = 1 to 3

Parameter	Description	Value
Position (0-100%)	This parameter defines the position to run the shutter or blind to on triggering of the relevant alarms.	0 ... 5* ... 100

Note: This parameter is only visible if the **Position on alarm X** parameter has the following value: **Specific position**.

Parameter	Description	Value
Slat angle (0-100%)	This parameter defines the slat position to apply to the blind on triggering of the relevant alarm.	0 ... 5* ... 100

Note: This parameter is only visible if the **Position on alarm X** parameter has the value **Specific position** and if the **Closing type** for channel parameter has the value **blind**.

Parameter	Description	Value
Scene	This parameter defines the scene number to be activated on triggering of the relevant alarm.	Scene 1 ... 64 Default value: 1

X = 1 to 3

The outputs respond according to the scene numbers and associated parameters.

Note: This parameter is only visible if the **Position on alarm X** parameter has the following value: **Scene**.

Parameter	Description	Value
Position after alarm X	After Alarm X, the shutter/blind output: Not changed. Closes the Up contact. Closes the down contact. Opens the 2 contacts. Runs to a specific position. Runs to a position set in a scene. Returns to the Position before alarm. Runs to the position which would be active according to other communication objects if the alarm had not taken place.	Maintain status* Up Down Stop Specific position Scene number Position before alarm Theoretical status without alarm X

X = 1 to 3

* Default value

Parameter	Description	Value
Position (0-100%)	This parameter defines the position to run the shutter or blind to on disappearing of the relevant alarms.	0 ... 5* ... 100

Note: This parameter is only visible if the **Position after alarm X** parameter has the following value: **Specific position**.

Parameter	Description	Value
Slat angle (0-100%)	This parameter defines the slat position to apply to the blind on disappearing of the relevant alarm.	0 ... 5* ... 100

Note: This parameter is only visible if the **Position after alarm X** parameter has the value **Specific position** and if the **Closing type** for channel parameter has the value **blind**.

Parameter	Description	Value
Scene	This parameter defines the scene number to be activated on disappearing of the relevant alarm.	Scene 1 ... 64 Default value: 1

X = 1 to 3

The outputs respond according to the scene numbers and associated parameters.

Note: This parameter is only visible if the **Position after alarm X** parameter has the following value: **Scene**.

If several alarms triggered at the same time, the commands associated with the highest priority alarm are executed. The following parameters allow definition of this priority according to the alarm number.

Parameter	Description	Value
Priority between alarm 1 and 2	This parameter defines the priority between 2 alarm functions.	Alarm 1 > Alarm 2* Alarm 2 > Alarm 1

Note: This parameter is only visible if the **Alarm** parameter has the following value: **2 alarm objects**.

Parameter	Description	Value
Priority between alarm 1, 2 and 3	This parameter defines the priority between 3 alarm functions.	Alarm 1 > Alarm 2 > Alarm 3* Alarm 1 > Alarm 3 > Alarm 2 Alarm 2 > Alarm 1 > Alarm 3 Alarm 2 > Alarm 3 > Alarm 1 Alarm 3 > Alarm 1 > Alarm 2 Alarm 3 > Alarm 2 > Alarm 1

Note: This parameter is only visible if the **Alarm** parameter has the following value: **3 alarm objects**.

* Default value

3.7.6.2 Alarm status indication

Parameter	Description	Value
Alarm status object	This parameter is used to authorize the Alarm status object. This object allows the status of the alarm to be sent from the device over the KNX bus.	Not active* Active

Communication objects:

- [21 - Output 1 - Alarm status indication \(1 bit - 1.011 DPT_State\)](#)
- [48 - Output 2 - Alarm status indication \(1 bit - 1.011 DPT_State\)](#)
- [75 - Output 3 - Alarm status indication \(1 bit - 1.011 DPT_State\)](#)
- [102 - Output 4 - Alarm status indication \(1 bit - 1.011 DPT_State\)](#)
- [129 - Output 5 - Alarm status indication \(1 bit - 1.011 DPT_State\)](#)
- [156 - Output 6 - Alarm status indication \(1 bit - 1.011 DPT_State\)](#)
- [183 - Output 7 - Alarm status indication \(1 bit - 1.011 DPT_State\)](#)
- [210 - Output 8 - Alarm status indication \(1 bit - 1.011 DPT_State\)](#)

Parameter	Description	Value
Polarity	The Alarm status object sends: 0 if no alarm is active. 1 if one of the three alarms is active. 1 if no alarm is active. 0 if one of the three alarms is active.	0 = Alarm deactivated, 1 = Alarm activated* 0 = Alarm activated, 1 = Alarm deactivated

Parameter	Description	Value
Emission	The Alarm status indication communication object is sent: On activation and deactivation of the alarm. Periodically after a configurable time. On activation and deactivation of the alarm and periodically after a configurable time.	On status change* Periodically On status change and periodically

Note: This parameter is only visible if the **Alarm status object** parameter has the following value: **Active**.

Parameter	Description	Value
Hours (h)	This parameter determines the time between the individual transmissions of the Status indication lock-up object.	0 hours: 0 to 23 h
Minutes (min)		30 minutes: 0 to 59 min
Seconds (s)		0 seconds: 0 to 59 s

Note: The smallest executable time is 1 second.

Note: This parameter is only visible if the **Emission** parameter has the following value: **Periodically** or **On status change and periodically**.

* Default value

3.7.6.3 Alarm monitoring period

Parameter	Description	Value
Alarm monitoring period	<p>The Alarm 1-3 objects</p> <p>Expect no periodic signal.</p> <p>Expect a periodic 0 signal.</p> <p>If this signal remains off, the super alarm is automatically activated the shutters/blinds are run to the position set by the Position on Alarm X parameter.</p>	<p>Not active*</p> <p>Active</p>

Parameter	Description	Value
Hours (h)	This parameter defines the maximum time between 2 signals on the Super alarm communication object.	0 hours: 0 to 23 h
Minutes (min)		15 minutes: 0 to 59 min
Seconds (s)		0 seconds: 0 to 59 s

Note: The smallest executable time is 1 second.

*Note: This parameter is only visible if the **Alarm monitoring period** parameter has the following value: **Active**.*

* Default value

3.7.7 Sun protection

Device: 1.1.3 8-fold blind actuator 6A 230V AC

<ul style="list-style-type: none"> Outputs 1-8: Function selection - O1-8: Manual mode - O1-8: Status indications Output 1: Function selection - O1: Sun protection Output 2: Function selection Output 3: Function selection Output 4: Function selection Output 5: Function selection Output 6: Function selection Output 7: Function selection Output 8: Function selection Information 	<p>Sun protection type: <input type="text" value="Objects position and slat angle"/></p> <p>Sun protection lock-up by local control: <input type="text" value="Active"/></p> <p>Lock-up on: <input type="text" value="Up/down and step/stop control"/></p> <p>Sun protection lock-up: <input type="text" value="Permanently"/></p> <p>Sun protection authorization object: <input type="text" value="Active"/></p> <p>Polarity: <input type="text" value="0 = Locked-up , 1 = Authorized"/></p> <p>Value at initialization: <input type="text" value="0"/></p> <p>Position after sun protection: <input type="text" value="Maintain status"/></p> <p>Sun protection status object: <input type="text" value="Active"/></p> <p>Polarity: <input type="text" value="0 = Locked-up , 1 = Authorized"/></p> <p>Emission: <input type="text" value="On status change"/></p>
---	--

General description of the sun protection controls:

Shade trim and slat adjustments

Using the shade trim control the Sun protection is not run all the way down but rather just so far down that only a configurable strip of sunshine (e.g. 50 cm) enters the room (e.g. 50 cm). In this way, users at the bottom of the window can see out and plants on the windowsill will receive sunshine.

Note: The shade trim adjustment is only usable with sun protection that runs from the top to the bottom (Such as shutters, textile sun protection or blinds with horizontal slats). This function is not usable for a sun protection that is pulled from one side to the other or pulled in front of a window from both sides.

During slat adjustment, the horizontal slats of the blinds are not fully closed; rather they are matched to the sun condition and set automatically in such a way that the sun cannot shine directly into the room.

However diffuse daylight can enter the room between the slats and so provide glare-free room lighting. Slat adjustment of an external blind prevents the entry of heat from sunshine into the room and, at the same time, reduces the cost of electricity for room lighting.

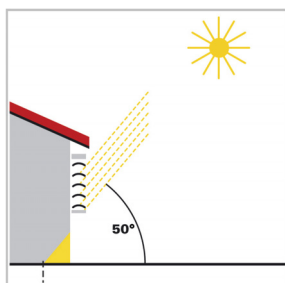

Sun protection at high sun elevations

The sun protection is only partially closed and automatically driven so far down that the sun can only shine into the room as far as the maximum permitted penetration depth. The slats can be made almost horizontal without the sun shining directly into the room.

Sun protection at medium sun elevations

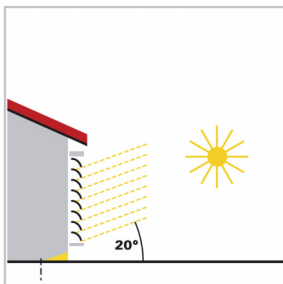

The sun protection will automatically be lowered so that the maximum penetration depth of sunshine into the room is not exceeded. The slats are automatically closed so far that the sun cannot shine directly into the room. Diffuse daylight, however, can still continue to enter and so provide lighting for the room (daylight use).

Sun protection at low sun elevations

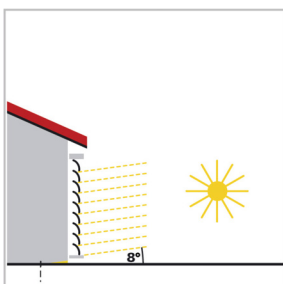

The sun protection is automatically lowered almost completely, so that the sun cannot shine too far into the room. The slats are automatically closed to an extent where the sun cannot shine directly into the room.

Parameter	Description	Value
Sun protection type	An external sun protection control sends the following commands for the positioning of the blinds: Positioning and slat adjustments. Positioning only. Slat adjustment only.	Objects position and slat angle* Position object only Slat angle object only

Note: These objects are only visible if the **Sun protection type** parameter has the following value: **Objects position and slat angle** or **Position object only**.

- Communication objects:
- 22 - Output 1 - Sun protection position % (1 byte - 5.001 DPT_Scaling)
 - 49 - Output 2 - Sun protection position % (1 byte - 5.001 DPT_Scaling)
 - 74 - Output 3 - Sun protection position % (1 byte - 5.001 DPT_Scaling)
 - 103 - Output 4 - Sun protection position % (1 byte - 5.001 DPT_Scaling)
 - 130 - Output 5 - Sun protection position % (1 byte - 5.001 DPT_Scaling)
 - 157 - Output 6 - Sun protection position % (1 byte - 5.001 DPT_Scaling)
 - 184 - Output 7 - Sun protection position % (1 byte - 5.001 DPT_Scaling)
 - 211 - Output 8 - Sun protection position % (1 byte - 5.001 DPT_Scaling)

Note: These objects are only visible if the **Sun protection type** parameter has the following value: **Objects position and slat angle** or **Slat angle object only**.

* Default value

Communication objects:

- 23 - Output 1 - Pos. lamelles poursuite sol. % (1 byte - 5.001 DPT_Scaling)
- 50 - Output 2 - Pos. lamelles poursuite sol. % (1 byte - 5.001 DPT_Scaling)
- 75 - Output 3 - Pos. lamelles poursuite sol. % (1 byte - 5.001 DPT_Scaling)
- 104 - Output 4 - Pos. lamelles poursuite sol. % (1 byte - 5.001 DPT_Scaling)
- 131 - Output 5 - Pos. lamelles poursuite sol. % (1 byte - 5.001 DPT_Scaling)
- 158 - Output 6 - Pos. lamelles poursuite sol. % (1 byte - 5.001 DPT_Scaling)
- 185 - Output 7 - Pos. lamelles poursuite sol. % (1 byte - 5.001 DPT_Scaling)
- 212 - Output 8 - Pos. lamelles poursuite sol. % (1 byte - 5.001 DPT_Scaling)

Parameter	Description	Value
Sun protection lock-up by local control	<p>This parameter allows lock-up of the Sun protection position in % object and the sun protection slat position in % after operation of the shutter/blind with local KNX controls.</p> <p>When this function is activated, the Sun protection reactivation object is also displayed. This allows a reactivation of both sun protection objects.</p>	<p>Not active*</p> <p>Active</p>

Communication objects:

- 25 - Output 1 - Sun protection reactivation (1 bit - 1.003 DPT_Enable)
- 52 - Output 2 - Sun protection reactivation (1 bit - 1.003 DPT_Enable)
- 77 - Output 3 - Sun protection reactivation (1 bit - 1.003 DPT_Enable)
- 106 - Output 4 - Sun protection reactivation (1 bit - 1.003 DPT_Enable)
- 133 - Output 5 - Sun protection reactivation (1 bit - 1.003 DPT_Enable)
- 160 - Output 6 - Sun protection reactivation (1 bit - 1.003 DPT_Enable)
- 187 - Output 7 - Sun protection reactivation (1 bit - 1.003 DPT_Enable)
- 214 - Output 8 - Sun protection reactivation (1 bit - 1.003 DPT_Enable)

Parameter	Description	Value
Lock-up on	<p>This parameter specifies on which local control commands the sun protection will lock up:</p> <p>Only after Up/Down (long key-press) commands.</p> <p>Only after slat step (short key-press) commands.</p> <p>After Up/Down and slat step command.</p> <p>After all basic commands.</p>	<p>Up/down control</p> <p>Step/stop control</p> <p>Up/down and step/stop control*</p> <p>All basic controls</p>

Note: This parameter is only visible if the **Deactivate sun protection by local control** parameter has the following value: **Active**.
 Note: All basic commands means the commands with the lowest priority (Scenes, Preset, etc...)

* Default value

Parameter	Description	Value
Sun protection lock-up	This parameter defines whether the Sun protection function is permanently activated or time-limited. The lock-up is active until it receives a 0 or 1 signal on the Sun protection reactivation object. The lock-up is active for a configurable time. After expiry of which the sun protection objects are again processed.	Permanently* Time limited

Parameter	Description	Value
Sun protection authorization object	With this parameter, the device's Sun protection authorization object can be activated or deactivated.	Not active* Active

Communication objects:

- 24 - Output 1 - Sun protection authorization (1 bit - 1.003 DPT_Enable)
- 51 - Output 2 - Sun protection authorization (1 bit- 1.003 DPT_Enable)
- 76 - Output 3 - Sun protection authorization (1 bit - 1.003 DPT_Enable)
- 105 - Output 4 - Sun protection authorization (1 bit - 1.003 DPT_Enable)
- 132 - Output 5 - Sun protection authorization (1 bit - 1.003 DPT_Enable)
- 159 - Output 6 - Sun protection authorization (1 bit - 1.003 DPT_Enable)
- 186 - Output 7 - Sun protection authorization (1 bit - 1.003 DPT_Enable)
- 213 - Output 8 - Sun protection authorization (1 bit - 1.003 DPT_Enable)

Principle of the Sun protection authorization function

The parameters are set as follows:

Sun protection authorization: 0 = Locked-up, 1 = Authorized

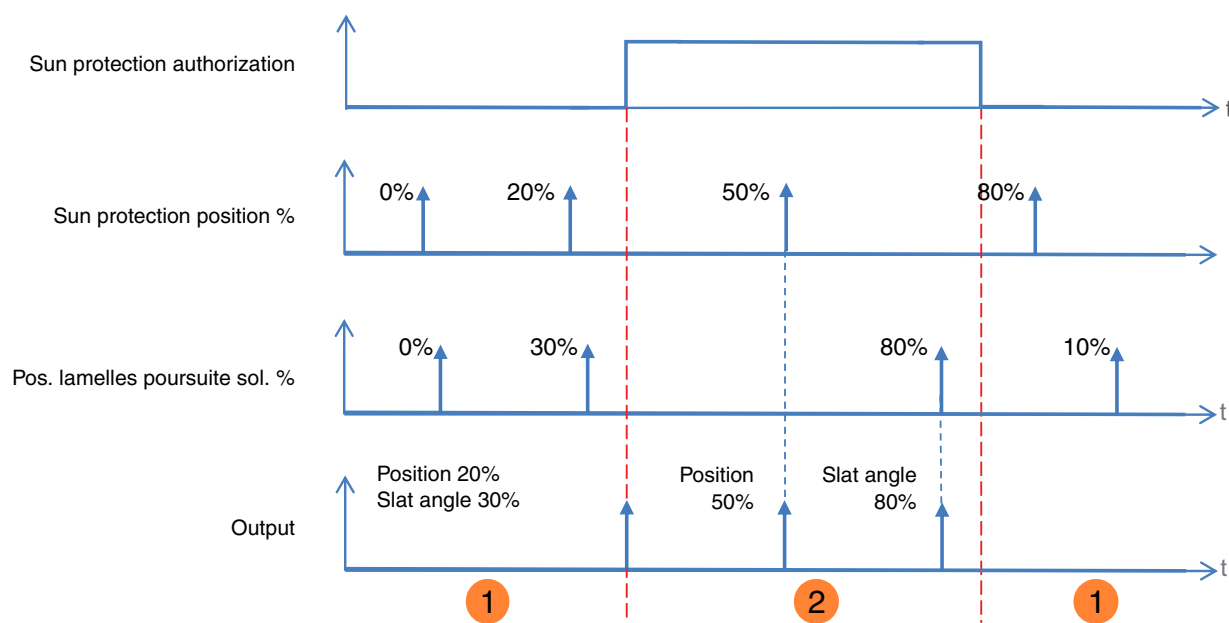

- 1 The Sun protection function has no effect on the output.
- 2 The commands from the sun protection functions are executed.

Note: The sun protection function commands will be executed immediately on authorization.

* Default value

Parameter	Description	Value
Polarity	<p>This parameter defines how the device reacts on receipt of a telegram to the Sun protection authorization object:</p> <p>0 = Sun protection locked-up (OFF) 1 = Sun protection authorized (ON)</p> <p>0 = Sun protection authorized (ON) 1 = Sun protection locked-up (OFF)</p>	<p>0 = Locked-up, 1 = Authorized*</p> <p>0 = Authorized, 1 = Locked-up</p>

Note: This parameter is only visible if the **Sun protection authorization object** parameter has the following value: **Active**.

Parameter	Description	Value
Value at initialization	<p>On initialization of the device after a download or after return of the bus power, the value of the Sun protection authorization object is:</p> <p>Set to 0.</p> <p>Set to 1.</p> <p>Set according to the value that the object had before initialization.</p>	<p>0*</p> <p>1</p> <p>Value before initialization</p>

Parameter	Description	Value
Position after sun protection	<p>After lock-up of the sun protection due to a 0 on the Sun protection authorization object, the output is:</p> <p>Not changed.</p> <p>Closes the Up contact.</p> <p>Closes the down contact.</p> <p>Runs to a specific position.</p> <p>Runs to a position set in a scene.</p> <p>Run to the position before the priority.</p>	<p>Maintain status*</p> <p>Up</p> <p>Down</p> <p>Specific position</p> <p>Scene number</p> <p>Position before sun protection</p>

Parameter	Description	Value
Position (0-100%)	This parameter defines the position to run the shutter or blind to.	0* ... 100

Note: This parameter is only visible if the **Position after sun protection** has the value **Specific position** and if the **Sun protection type** parameter has the value **Position and Slat position object** or **only position object**.

Parameter	Description	Value
Slat angle (0-100%)	This parameter defines the slat position to use for the blind.	0* ... 100

Note: This parameter is only visible if the **Position after sun protection** has the value **Specific position** and if the **Sun protection type** parameter has the value **Position and Slat position object** or **Position only object**.

* Default value

Parameter	Description	Value
Scene	This parameter defines the scene number that is to be activated after the sun protection.	Scene 1 ... 64 Default value: 1

The outputs respond according to the scene numbers and associated parameters.

*Note: This parameter is only visible if the **Position after sun protection** parameter has the following value: **Scene**.*

Parameter	Description	Value
Sun protection status object.	This parameter is used to authorize the Sun protection status object. This object allows the status of the sun protection to be sent from the device to the KNX bus.	Not active* Active

Communication objects:

- [26 - Output 1 - Sun protection status \(1 bit - 1.011 DPT_State\)](#)
- [53 - Output 2 - Sun protection status \(1 bit - 1.011 DPT_State\)](#)
- [78 - Output 3 - Sun protection status \(1 bit - 1.011 DPT_State\)](#)
- [107 - Output 4 - Sun protection status \(1 bit - 1.011 DPT_State\)](#)
- [134 - Output 5 - Sun protection status \(1 bit - 1.011 DPT_State\)](#)
- [161 - Output 6 - Sun protection status \(1 bit - 1.011 DPT_State\)](#)
- [188 - Output 7 - Sun protection status \(1 bit - 1.011 DPT_State\)](#)
- [215 - Output 8 - Sun protection status \(1 bit - 1.011 DPT_State\)](#)

Parameter	Description	Value
Polarity	This parameter defines the polarity of the Sun protection status : 0 = Sun protection locked-up 1 = Sun protection authorized 0 = Sun protection authorized 1 = Sun protection locked-up	0 = Locked-up, 1 = Authorized* 0 = Authorized, 1 = Locked-up

*Note: This parameter is only visible if the **Sun protection status object** parameter has the following value: **Active**.*

Parameter	Description	Value
Emission	The Sun protection status communication object is sent: On activation and deactivation of the lock-up. Periodically after a configurable time. On activation and deactivation of the lock-up and periodically after a configurable time.	On status change* Periodically On status change and periodically

*Note: This parameter is only visible if the **Sun protection status object** parameter has the following value: **Active**.*

Parameter	Description	Value
Hours (h)	This parameter determines the time between the individual transmissions of the Sun protection status objects.	0 hours: 0 to 23 h
Minutes (min)		30 minutes: 0 to 59 min
Seconds (s)		0 seconds: 0 to 59 s







































Note: The smallest executable time is 1 second.

*Note: This parameter is only visible if the **Emission** parameter has the following value: **Periodically** or **On status change and periodically**.*

* Default value

4. Communication objects

4.1 Communication objects General

	Number	Name	Function of the object	Length	C	R	W	T
 	216	Outputs 1-8	Super alarm	1 bit	C	R	W	-
 	217	Outputs 1-8	Super alarm status	1 bit	C	R	-	T
 	218	Outputs 1-8	Deactivation of manual mode	1 bit	C	R	W	-
 	219	Outputs 1-8	Status indication manual mode	1 bit	C	R	-	T
 	220	Logic block 1	Authorization	1 bit	C	R	W	-
 	221	Logic block 1	Input 1	1 bit	C	R	W	-
 	222	Logic block 1	Input 2	1 bit	C	R	W	-
 	223	Logic block 1	Input 3	1 bit	C	R	W	-
 	224	Logic block 1	Input 4	1 bit	C	R	W	-
 	225	Logic block 1	Logic result	1 bit	C	R	-	T
 	226	Logic block 2	Authorization	1 bit	C	R	W	-
 	227	Logic block 2	Input 1	1 bit	C	R	W	-
 	228	Logic block 2	Input 2	1 bit	C	R	W	-
 	229	Logic block 2	Input 3	1 bit	C	R	W	-
 	230	Logic block 2	Input 4	1 bit	C	R	W	-
 	231	Logic block 2	Logic result	1 bit	C	R	-	T
 	232	Outputs 1-8	Restore ETS-params settings	1 bit	C	R	W	-
 	233	Outputs 1-8	Device LED switch off	1 bit	C	R	W	-
 	234	Outputs 1-8	Diagnosis	6 byte	C	R	-	T

4.1.1 Super alarm

No.	Name	Function of the object	Data type	Flags
216	Outputs 1-8	Super alarm	1 bit - 1.005 DPT_Alarm	C, R, W

This object is activated when the **Super alarm** parameter is active.
 This function is used to set all the outputs of the device into a configurable blocked state.
 If the object receives the value 1, all the outputs of the device are switched to a predefined status. All other functions, including manual mode, will be locked.
 The function can only be ended by receipt of a telegram with the value 0.
 For further information, see: [Super alarm](#).

No.	Name	Function of the object	Data type	Flags
217	Outputs 1-8	Super alarm status	1 bit - 1.005 DPT_Alarm	C, R, T

This object is activated when the **Status indication super alarm** parameter is active.
 This object allows the status of the super alarm to be sent over the KNX bus.
 Object value: Depends on the **Polarity** parameter.

0 = activated, 1 = deactivated

- If the super alarm is deactivated, a telegram with logic value 1 is sent on the KNX bus.
- If the super alarm is activated, a telegram with logic value 0 is sent on the KNX bus.

0 = deactivated, 1 = activated

- If the super alarm is activated, a telegram with logic value 1 is sent on the KNX bus.
- If the super alarm is deactivated, a telegram with logic value 0 is sent on the KNX bus.

This object is sent periodically and/or on status change.
 For further information, see: [Super alarm](#).

4.1.2 Manual mode

No.	Name	Function of the object	Data type	Flags
218	Outputs 1-8	Deactivation of manual mode	1 bit - 1.001 DPT_Switch	C, R, W
<p>This object is activated if the Manual mode parameter and the Deactivation of manual mode object are active. This object is used to control the manual mode via the KNX bus. Object value: Depends on the Polarity parameter.</p> <p>0 = Manual mode locked-up, 1 = Manual mode authorized:</p> <ul style="list-style-type: none"> - If the object receives the value 1, manual mode is activated. - If the object receives the value 0, manual mode is deactivated. <p>0 = Manual mode authorized, 1 = Manual mode locked-up:</p> <ul style="list-style-type: none"> - If the object receives the value 1, manual mode is deactivated. - If the object receives the value 0, manual mode is activated. <p>For further information, see: Manual mode.</p>				

No.	Name	Function of the object	Data type	Flags
219	Outputs 1-8	Status indication manual mode	1 bit - 1.011 DPT_State	C, R, T
<p>This object is activated if the Manual mode parameter and the Deactivation of manual mode object are active. This object is used to send the manual mode status of the device via the KNX bus. Object value: Depends on the Polarity parameter.</p> <p>0 = Manual mode activated, 1 = Manual mode deactivated:</p> <ul style="list-style-type: none"> - If manual mode is deactivated, a telegram is sent with logic value 1. - If manual mode is activated, a telegram is sent with logic value 0. <p>0 = Manual mode deactivated, 1 = Manual mode activated:</p> <ul style="list-style-type: none"> - If manual mode is activated, a telegram is sent with logic value 1. - If manual mode is deactivated, a telegram is sent with logic value 0. <p>This object is sent periodically and/or on status change. For further information, see: Manual mode.</p>				

4.1.3 Logic block

No.	Name	Function of the object	Data type	Flags
220	Logic block 1	Authorization	1 bit - 1.003 DPT_Enable	C, R, W
<p>This object is activated if the Logic block 1 parameter and the Lock-up logic block object are active. This object makes it possible to activate or deactivate the logic blocks of the device via the KNX bus. Object value: Depends on the Polarity parameter.</p> <p>0 = Locked-up, 1 = Authorized:</p> <ul style="list-style-type: none"> - If the object receives the value 0, logic block 1 is deactivated. - If the object receives the value 1, logic block 1 is activated. <p>0 = Authorized, 1 = Locked-up:</p> <ul style="list-style-type: none"> - If the object receives the value 0, logic block 1 is activated. - If the object receives the value 1, logic block 1 is deactivated. <p>The value of this object can be initialized at start-up of the device. For further information, see: Logic block.</p>				

No.	Name	Function of the object	Data type	Flags
221	Logic block 1	Input 1	1 bit - 1.002 DPT_Bool	C, R, W
222	Logic block 1	Input 2	1 bit - 1.002 DPT_Bool	C, R, W
223	Logic block 1	Input 3	1 bit - 1.002 DPT_Bool	C, R, W
224	Logic block 1	Input 4	1 bit - 1.002 DPT_Bool	C, R, W
<p>These objects are activated in accordance with the value of the Number of logic inputs parameter. There may be up to a maximum of 4 of these objects. These objects are used to produce the status of a logic input for processing of the logic operation. The value of these objects can be initialized at start-up of the device.</p> <p>For further information, see: Logic block.</p>				

No.	Name	Function of the object	Data type	Flags
225	Logic block 1	Logic result	1 bit - 1.002 DPT_Bool	C, R, T
<p>This object is activated when the Logic block 1 parameter is active. This object enables output of the results of the logic operation via the bus. The value of the object is the result of a logic AND or OR operation, according to the status of the logic inputs. There may be up to a maximum of 4 of these objects. This result can also be directly assigned to the status of the output contact.</p> <p>For further information, see: Logic block.</p>				

No.	Name	Function of the object	Data type	Flags
226	Logic block 2	Authorization	1 bit - 1.003 DPT_Enable	C, R, W
See object No. 220				

No.	Name	Function of the object	Data type	Flags
227	Logic block 2	Input 1	1 bit - 1.002 DPT_Bool	C, R, W
228	Logic block 2	Input 2	1 bit - 1.002 DPT_Bool	C, R, W
229	Logic block 2	Input 3	1 bit - 1.002 DPT_Bool	C, R, W
230	Logic block 2	Input 4	1 bit - 1.002 DPT_Bool	C, R, W
See object No. 221				

No.	Name	Function of the object	Data type	Flags
231	Logic block 2	Logic result	1 bit - 1.002 DPT_Bool	C, R, T
See object No. 225				

4.1.4 Behaviour of the device

No.	Name	Function of the object	Data type	Flags
232	Outputs 1-8	Restore ETS-params settings	1 bit - 1.015 DPT_Reset	C, R, W
<p>This object is activated if the Activ. of restore ETS-parameters object (scenes, timer, setpoints) parameter is active. This object enables the current parameter value to be replaced at any time with the ETS parameter value. If the object receives value 1, then the output status values for the scenes, the timer duration specifications and all the counter setpoints are reset to the values sent by the last download.</p> <p>For further information, see: Restore ETS-Parameters.</p>				

No.	Name	Function of the object	Data type	Flags
233	Outputs 1-8	Device LED switch off	1 bit - 1.001 DPT_Switch	C, R, W
<p>This object is activated if the Device LEDS lock-up object parameter is active. This function is used to reduce the overall power consumption of the device. It allows the LEDs on the front of the device to be switched off. Object value: Depends on the Polarity parameter.</p> <p>0 = Status indication, 1 = Always OFF:</p> <ul style="list-style-type: none"> - If the object receives value 0, the LED display is activated. - If the object receives value 1, the LED display is deactivated. <p>0 = Always OFF, 1 = Status indication:</p> <ul style="list-style-type: none"> - If the object receives value 0, the LED display is deactivated. - If the object receives value 1, the LED display is activated. <p>For further information, see: LED display.</p>				

4.1.5 Diagnosis

No.	Name	Function of the object	Data type	Flags														
234	Outputs 1-8	Diagnosis	6 byte - Specific	C, R, T														
<p>This object is activated when the Device diagnosis object parameter is active. The object enables reporting of current faults according to the device and the application used. It also allows sending of the position of the switch on the front of the device and the number of the output that is affected by the fault(s).</p> <table border="1" style="width: 100%; border-collapse: collapse;"> <thead> <tr> <th>Byte number</th> <th>6 (MSB)</th> <th>5</th> <th>4</th> <th>3</th> <th>2</th> <th>1(LSB)</th> </tr> </thead> <tbody> <tr> <td>Use</td> <td>Switch position</td> <td>Application type</td> <td>Output number</td> <td colspan="3">Error codes</td> </tr> </tbody> </table> <p>This object is sent periodically and/or on status change.</p> <p>For further information, see: Diagnosis.</p>					Byte number	6 (MSB)	5	4	3	2	1(LSB)	Use	Switch position	Application type	Output number	Error codes		
Byte number	6 (MSB)	5	4	3	2	1(LSB)												
Use	Switch position	Application type	Output number	Error codes														

4.2 Output communication objects

	Number	Name	Function of the object	Length	C	R	W	T
	0	Output 1	Up/Down (long key-press)	1 bit	C	R	W	-
	1	Output 1	Step/stop (short press)	1 bit	C	R	W	-
	2	Output 1	Position in %	1 byte	C	R	W	-
	3	Output 1	Slat angle (0-100%)	1 byte	C	R	W	-
	4	Output 1	Position in % indication	1 byte	C	R	-	T
	5	Output 1	Slat angle indication in %	1 byte	C	R	-	T
	6	Output 1	Upper position reached	1 bit	C	R	-	T
	7	Output 1	Lower position reached	1 bit	C	R	-	T
	8	Output 1	Scene	1 byte	C	R	W	-
	9	Output 1	Preset 1	1 bit	C	R	W	-
	10	Output 1	Preset 2	1 bit	C	R	W	-
	11	Output 1	Preset 1 authorization	1 bit	C	R	W	-
	12	Output 1	Preset 2 authorization	1 bit	C	R	W	-
	13	Output 1	Lock-up 1	1 bit	C	R	W	-
	14	Output 1	Lock-up 2	1 bit	C	R	W	-
	15	Output 1	Status indication lock-up	1 bit	C	R	-	T
	16	Output 1	Priority	2 bit	C	R	W	-
	17	Output 1	Status indication priority	1 bit	C	R	-	T
	18	Output 1	Alarm 1	1 bit	C	R	W	-
	19	Output 1	Alarm 2	1 bit	C	R	W	-
	20	Output 1	Alarm 3	1 bit	C	R	W	-
	21	Output 1	Alarm status object	1 bit	C	R	-	T
	22	Output 1	Sun protection position %	1 byte	C	R	W	-
	23	Output 1	Pos. lamelles poursuite sol. %	1 byte	C	R	W	-
	24	Output 1	Sun protection authorization	1 bit	C	R	W	-
	25	Output 1	Sun protection reactivation	1 bit	C	R	W	-
	26	Output 1	Sun protection status	1 bit	C	R	-	T

	Number	Name	Function of the object	Length	C	R	W	T
	27	Output 2	Up/Down (long key-press)	1 bit	C	R	W	-
	28	Output 2	Step/stop (short press)	1 bit	C	R	W	-
	29	Output 2	Position in %	1 byte	C	R	W	-
	30	Output 2	Slat angle (0-100%)	1 byte	C	R	W	-
	31	Output 2	Position in % indication	1 byte	C	R	-	T
	32	Output 2	Slat angle indication in %	1 byte	C	R	-	T
	33	Output 2	Upper position reached	1 bit	C	R	-	T
	34	Output 2	Lower position reached	1 bit	C	R	-	T
	35	Output 2	Scene	1 byte	C	R	W	-
	36	Output 2	Preset 1	1 bit	C	R	W	-
	37	Output 2	Preset 2	1 bit	C	R	W	-
	38	Output 2	Preset 1 authorization	1 bit	C	R	W	-
	39	Output 2	Preset 2 authorization	1 bit	C	R	W	-
	40	Output 2	Lock-up 1	1 bit	C	R	W	-
	41	Output 2	Lock-up 2	1 bit	C	R	W	-
	42	Output 2	Status indication lock-up	1 bit	C	R	-	T
	43	Output 2	Priority	2 bit	C	R	W	-
	44	Output 2	Status indication priority	1 bit	C	R	-	T
	45	Output 2	Alarm 1	1 bit	C	R	W	-
	46	Output 2	Alarm 2	1 bit	C	R	W	-
	47	Output 2	Alarm 3	1 bit	C	R	W	-
	48	Output 2	Alarm status object	1 bit	C	R	-	T
	49	Output 2	Sun protection position %	1 byte	C	R	W	-
	50	Output 2	Pos. lamelles poursuite sol. %	1 byte	C	R	W	-
	51	Output 2	Sun protection authorization	1 bit	C	R	W	-
	52	Output 2	Sun protection reactivation	1 bit	C	R	W	-
	53	Output 2	Sun protection status	1 bit	C	R	-	T

	Number	Name	Function of the object	Length	C	R	W	T
	54	Output 3	Up/Down (long key-press)	1 bit	C	R	W	-
	55	Output 3	Step/stop (short press)	1 bit	C	R	W	-
	56	Output 3	Position in %	1 byte	C	R	W	-
	57	Output 3	Slat angle (0-100%)	1 byte	C	R	W	-
	58	Output 3	Position in % indication	1 byte	C	R	-	T
	59	Output 3	Slat angle indication in %	1 byte	C	R	-	T
	60	Output 3	Upper position reached	1 bit	C	R	-	T
	61	Output 3	Lower position reached	1 bit	C	R	-	T
	62	Output 3	Scene	1 byte	C	R	W	-
	63	Output 3	Preset 1	1 bit	C	R	W	-
	64	Output 3	Preset 2	1 bit	C	R	W	-
	65	Output 3	Preset 1 authorization	1 bit	C	R	W	-
	66	Output 3	Preset 2 authorization	1 bit	C	R	W	-
	67	Output 3	Lock-up 1	1 bit	C	R	W	-
	68	Output 3	Lock-up 2	1 bit	C	R	W	-
	69	Output 3	Status indication lock-up	1 bit	C	R	-	T
	70	Output 3	Priority	2 bit	C	R	W	-
	71	Output 3	Status indication priority	1 bit	C	R	-	T
	72	Output 3	Alarm 1	1 bit	C	R	W	-
	73	Output 3	Alarm 2	1 bit	C	R	W	-
	74	Output 3	Alarm 3	1 bit	C	R	W	-
	75	Output 3	Alarm status object	1 bit	C	R	-	T
	76	Output 3	Sun protection position %	1 byte	C	R	W	-
	77	Output 3	Pos. lamelles poursuite sol. %	1 byte	C	R	W	-
	78	Output 3	Sun protection authorization	1 bit	C	R	W	-
	79	Output 3	Sun protection reactivation	1 bit	C	R	W	-
	80	Output 3	Sun protection status	1 bit	C	R	-	T

	Number	Name	Function of the object	Length	C	R	W	T
	81	Output 4	Up/Down (long key-press)	1 bit	C	R	W	-
	82	Output 4	Step/stop (short press)	1 bit	C	R	W	-
	83	Output 4	Position in %	1 byte	C	R	W	-
	84	Output 4	Slat angle (0-100%)	1 byte	C	R	W	-
	85	Output 4	Position in % indication	1 byte	C	R	-	T
	86	Output 4	Slat angle indication in %	1 byte	C	R	-	T
	87	Output 4	Upper position reached	1 bit	C	R	-	T
	88	Output 4	Lower position reached	1 bit	C	R	-	T
	89	Output 4	Scene	1 byte	C	R	W	-
	90	Output 4	Preset 1	1 bit	C	R	W	-
	91	Output 4	Preset 2	1 bit	C	R	W	-
	92	Output 4	Preset 1 authorization	1 bit	C	R	W	-
	93	Output 4	Preset 2 authorization	1 bit	C	R	W	-
	94	Output 4	Lock-up 1	1 bit	C	R	W	-
	95	Output 4	Lock-up 2	1 bit	C	R	W	-
	96	Output 4	Status indication lock-up	1 bit	C	R	-	T
	97	Output 4	Priority	2 bit	C	R	W	-
	98	Output 4	Status indication priority	1 bit	C	R	-	T
	99	Output 4	Alarm 1	1 bit	C	R	W	-
	100	Output 4	Alarm 2	1 bit	C	R	W	-
	101	Output 4	Alarm 3	1 bit	C	R	W	-
	102	Output 4	Alarm status object	1 bit	C	R	-	T
	103	Output 4	Sun protection position %	1 byte	C	R	W	-
	104	Output 4	Pos. lamelles poursuite sol. %	1 byte	C	R	W	-
	105	Output 4	Sun protection authorization	1 bit	C	R	W	-
	106	Output 4	Sun protection reactivation	1 bit	C	R	W	-
	107	Output 4	Sun protection status	1 bit	C	R	-	T

	Number	Name	Function of the object	Length	C	R	W	T
	108	Output 5	Up/Down (long key-press)	1 bit	C	R	W	-
	109	Output 5	Step/stop (short press)	1 bit	C	R	W	-
	110	Output 5	Position in %	1 byte	C	R	W	-
	111	Output 5	Slat angle (0-100%)	1 byte	C	R	W	-
	112	Output 5	Position in % indication	1 byte	C	R	-	T
	113	Output 5	Slat angle indication in %	1 byte	C	R	-	T
	114	Output 5	Upper position reached	1 bit	C	R	-	T
	115	Output 5	Lower position reached	1 bit	C	R	-	T
	116	Output 5	Scene	1 byte	C	R	W	-
	117	Output 5	Preset 1	1 bit	C	R	W	-
	118	Output 5	Preset 2	1 bit	C	R	W	-
	119	Output 5	Preset 1 authorization	1 bit	C	R	W	-
	120	Output 5	Preset 2 authorization	1 bit	C	R	W	-
	121	Output 5	Lock-up 1	1 bit	C	R	W	-
	122	Output 5	Lock-up 2	1 bit	C	R	W	-
	123	Output 5	Status indication lock-up	1 bit	C	R	-	T
	124	Output 5	Priority	2 bit	C	R	W	-
	125	Output 5	Status indication priority	1 bit	C	R	-	T
	126	Output 5	Alarm 1	1 bit	C	R	W	-
	127	Output 5	Alarm 2	1 bit	C	R	W	-
	128	Output 5	Alarm 3	1 bit	C	R	W	-
	129	Output 5	Alarm status object	1 bit	C	R	-	T
	130	Output 5	Sun protection position %	1 byte	C	R	W	-
	131	Output 5	Pos. lamelles poursuite sol. %	1 byte	C	R	W	-
	132	Output 5	Sun protection authorization	1 bit	C	R	W	-
	133	Output 5	Sun protection reactivation	1 bit	C	R	W	-
	134	Output 5	Sun protection status	1 bit	C	R	-	T

	Number	Name	Function of the object	Length	C	R	W	T
	135	Output 6	Up/Down (long key-press)	1 bit	C	R	W	-
	136	Output 6	Step/stop (short press)	1 bit	C	R	W	-
	137	Output 6	Position in %	1 byte	C	R	W	-
	138	Output 6	Slat angle (0-100%)	1 byte	C	R	W	-
	139	Output 6	Position in % indication	1 byte	C	R	-	T
	140	Output 6	Slat angle indication in %	1 byte	C	R	-	T
	141	Output 6	Upper position reached	1 bit	C	R	-	T
	142	Output 6	Lower position reached	1 bit	C	R	-	T
	143	Output 6	Scene	1 byte	C	R	W	-
	144	Output 6	Preset 1	1 bit	C	R	W	-
	145	Output 6	Preset 2	1 bit	C	R	W	-
	146	Output 6	Preset 1 authorization	1 bit	C	R	W	-
	147	Output 6	Preset 2 authorization	1 bit	C	R	W	-
	148	Output 6	Lock-up 1	1 bit	C	R	W	-
	149	Output 6	Lock-up 2	1 bit	C	R	W	-
	150	Output 6	Status indication lock-up	1 bit	C	R	-	T
	151	Output 6	Priority	2 bit	C	R	W	-
	152	Output 6	Status indication priority	1 bit	C	R	-	T
	153	Output 6	Alarm 1	1 bit	C	R	W	-
	154	Output 6	Alarm 2	1 bit	C	R	W	-
	155	Output 6	Alarm 3	1 bit	C	R	W	-
	156	Output 6	Alarm status object	1 bit	C	R	-	T
	157	Output 6	Sun protection position %	1 byte	C	R	W	-
	158	Output 6	Pos. lamelles poursuite sol. %	1 byte	C	R	W	-
	159	Output 6	Sun protection authorization	1 bit	C	R	W	-
	160	Output 6	Sun protection reactivation	1 bit	C	R	W	-
	161	Output 6	Sun protection status	1 bit	C	R	-	T

	Number	Name	Function of the object	Length	C	R	W	T
	162	Output 7	Up/Down (long key-press)	1 bit	C	R	W	-
	163	Output 7	Step/stop (short press)	1 bit	C	R	W	-
	164	Output 7	Position in %	1 byte	C	R	W	-
	165	Output 7	Slat angle (0-100%)	1 byte	C	R	W	-
	166	Output 7	Position in % indication	1 byte	C	R	-	T
	167	Output 7	Slat angle indication in %	1 byte	C	R	-	T
	168	Output 7	Upper position reached	1 bit	C	R	-	T
	169	Output 7	Lower position reached	1 bit	C	R	-	T
	170	Output 7	Scene	1 byte	C	R	W	-
	171	Output 7	Preset 1	1 bit	C	R	W	-
	172	Output 7	Preset 2	1 bit	C	R	W	-
	173	Output 7	Preset 1 authorization	1 bit	C	R	W	-
	174	Output 7	Preset 2 authorization	1 bit	C	R	W	-
	175	Output 7	Lock-up 1	1 bit	C	R	W	-
	176	Output 7	Lock-up 2	1 bit	C	R	W	-
	177	Output 7	Status indication lock-up	1 bit	C	R	-	T
	178	Output 7	Priority	2 bit	C	R	W	-
	179	Output 7	Status indication priority	1 bit	C	R	-	T
	180	Output 7	Alarm 1	1 bit	C	R	W	-
	181	Output 7	Alarm 2	1 bit	C	R	W	-
	182	Output 7	Alarm 3	1 bit	C	R	W	-
	183	Output 7	Alarm status object	1 bit	C	R	-	T
	184	Output 7	Sun protection position %	1 byte	C	R	W	-
	185	Output 7	Pos. lamelles poursuite sol. %	1 byte	C	R	W	-
	186	Output 7	Sun protection authorization	1 bit	C	R	W	-
	187	Output 7	Sun protection reactivation	1 bit	C	R	W	-
	188	Output 7	Sun protection status	1 bit	C	R	-	T

	Number	Name	Function of the object	Length	C	R	W	T
	189	Output 8	Up/Down (long key-press)	1 bit	C	R	W	-
	190	Output 8	Step/stop (short press)	1 bit	C	R	W	-
	191	Output 8	Position in %	1 byte	C	R	W	-
	192	Output 8	Slat angle (0-100%)	1 byte	C	R	W	-
	193	Output 8	Position in % indication	1 byte	C	R	-	T
	194	Output 8	Slat angle indication in %	1 byte	C	R	-	T
	195	Output 8	Upper position reached	1 bit	C	R	-	T
	196	Output 8	Lower position reached	1 bit	C	R	-	T
	197	Output 8	Scene	1 byte	C	R	W	-
	198	Output 8	Preset 1	1 bit	C	R	W	-
	199	Output 8	Preset 2	1 bit	C	R	W	-
	200	Output 8	Preset 1 authorization	1 bit	C	R	W	-
	201	Output 8	Preset 2 authorization	1 bit	C	R	W	-
	202	Output 8	Lock-up 1	1 bit	C	R	W	-
	203	Output 8	Lock-up 2	1 bit	C	R	W	-
	204	Output 8	Status indication lock-up	1 bit	C	R	-	T
	205	Output 8	Priority	2 bit	C	R	W	-
	206	Output 8	Status indication priority	1 bit	C	R	-	T
	207	Output 8	Alarm 1	1 bit	C	R	W	-
	208	Output 8	Alarm 2	1 bit	C	R	W	-
	209	Output 8	Alarm 3	1 bit	C	R	W	-
	210	Output 8	Alarm status object	1 bit	C	R	-	T
	211	Output 8	Sun protection position %	1 byte	C	R	W	-
	212	Output 8	Pos. lamelles poursuite sol. %	1 byte	C	R	W	-
	213	Output 8	Sun protection authorization	1 bit	C	R	W	-
	214	Output 8	Sun protection reactivation	1 bit	C	R	W	-
	215	Output 8	Sun protection status	1 bit	C	R	-	T

Note: For devices with additional outputs, object designation is identical. Only the object number differs.

4.2.1 Control

No.	Name	Function of the object	Data type	Flags
0, 27, 54, 81, 108, 135, 162, 189	Output x	Up/Down (long key-press)	1 bit - 1.008 DPT_UpDown	C, R, W

These objects are always activated. It is used to control the shutter or blind in connection with the value that is sent on the KNX bus.

Object value:

- If the object receives value 0, the shutter or blind moves to the upper position.
- If the object receives value 1, the shutter or blind moves to the lower position.

For further information, see: [Definition](#).

No.	Name	Function of the object	Data type	Flags
1, 28, 55, 82, 109, 136, 163, 190	Output x	Step/stop (short press)	1 bit - 1.007 DPT_Step	C, R, W

These objects are always activated. It is used to stop the movement of the shutter or blind or the tilting of the slats according to the value that is sent on the KNX bus.

Object value:

- Regardless of which value (0 or 1) is sent to this object, the movement of the shutter or blind will be stopped.
- If the object receives the value 0, the slats will be opened by one slat step.
- If the object receives the value 1, the slats will be closed by one slat step.

For further information, see: [Definition](#).

No.	Name	Function of the object	Data type	Flags
2, 29, 56, 83, 110, 137, 164, 191	Output x	Position in %	1 byte - 5.001 DPT_Scaling	C, R, W

These objects are always activated. It is used for positioning the shutter or blind at the desired height, in response to the value sent on the KNX bus.

On the blind, the slats have the same tilt after reaching the same position as they had before the movement.

If a telegram is received during the movement of the shutter or blind, the shutter will be positioned at the desired height after the originally requested position has been reached.

Object value: 0 to 255

- 0 (0%): Upper position
- 255 (100%): Lower position

For further information, see: [Definition](#).

No.	Name	Function of the object	Data type	Flags
3, 30, 57, 84, 111, 138, 165, 192	Output x	Slat angle in %	1 byte - 5.001 DPT_Scaling	C, R, W
<p>These objects are always activated. It is used to position the shutter or blind in response to the value that is sent on the KNX bus.</p> <p>Object value: 0 to 255</p> <ul style="list-style-type: none"> - 0 (0%): Slats open - 255 (100%): Slats closed <p>For further information, see: Definition.</p>				

4.2.2 Status indication

No.	Name	Function of the object	Data type	Flags
4, 31, 58, 85, 112, 139, 166, 193	Output x	Position in % indication	1 byte - 5.001 DPT_Scaling	C, R, T
<p>This object is activated when the Status indication position in % parameter is active.</p> <p>This object allows the status of the position to be sent over the KNX bus. It is sent after the position of the blind or shutter has been achieved.</p> <p>Object value: 0 to 255</p> <ul style="list-style-type: none"> - 0 (0%): Upper position - 255 (100%): Lower position <p>This object is sent periodically and/or on status change.</p> <p>For further information, see: Status indication.</p>				

No.	Name	Function of the object	Data type	Flags
5, 32, 59, 86, 113, 140, 167, 194	Output x	Slat angle indication in %	1 byte - 5.001 DPT_Scaling	C, R, T
<p>This object is activated when the Status indication slat angle in % parameter is active.</p> <p>This object allows the status of the slat angle to be sent over the KNX bus. It is sent after the tilting of the blind has been achieved.</p> <p>Object value: 0 to 255</p> <ul style="list-style-type: none"> - 0 (0%): Slats open - 255 (100%): Slats closed <p>This object is sent periodically and/or on status change.</p> <p>For further information, see: Status indication.</p>				

No.	Name	Function of the object	Data type	Flags
6, 33, 60, 87, 114, 141, 168, 195	Output x	Upper position reached	1 bit - 1.002 DPT_Bool	C, R, T

This object is activated when the **Upper position reached objects** parameter is active.
 This object is used to send the status of the upper position of the shutter or blind over the KNX bus.
 Object value: Depends on the **Polarity** parameter.

0 = Position not reached, 1 = Position reached

- If the upper position of the shutter or blind is not reached, a telegram is sent with a logic value of 0 on the KNX bus.
- If the upper position of the shutter or blind is reached, a telegram is sent with a logic value of 1 on the KNX bus.

0 = Position reached, 1 = Position not reached

- If the upper position of the shutter or blind is reached, a telegram is sent with a logic value of 0 on the KNX bus.
- If the upper position of the shutter or blind is not reached, a telegram is sent with a logic value of 1 on the KNX bus

This object is sent periodically and/or on status change.

For further information, see: [Status indication](#).

No.	Name	Function of the object	Data type	Flags
7, 34, 61, 88, 115, 142, 169, 196	Output x	Lower position reached	1 bit - 1.002 DPT_Bool	C, R, T

This object is activated if the **Lower position reached objects** parameter is active.
 This object is used to send the status of the lower position of the shutter or blind over the KNX bus.
 Object value: Depends on the **Polarity** parameter.

0 = Position not reached, 1 = Position reached

- If the lower position of the shutter or blind is not reached, a telegram is sent with a logic value of 0 on the KNX bus.
- If the lower position of the shutter or blind is reached, a telegram is sent with a logic value of 1 on the KNX bus.

0 = Position reached, 1 = Position not reached

- If the lower position of the shutter or blind is reached, a telegram is sent with a logic value of 0 on the KNX bus.
- If the lower position of the shutter or blind is not reached, a telegram is sent with a logic value of 1 on the KNX bus

This object is sent periodically and/or on status change.

For further information, see: [Status indication](#).

4.2.3 Scene

No.	Name	Function of the object	Data type	Flags																
8, 35, 62, 89, 116, 143, 170, 197	Output x	Scene	1 byte - 17.001 DPT_SceneNumber	C, R, W																
<p>This object is activated when the Scene parameter is active. This object is used to recall or save a scene. Details on the format of the object are given below.</p> <table border="1" style="margin-left: 40px;"> <tr> <td style="text-align: center;">7</td> <td style="text-align: center;">6</td> <td style="text-align: center;">5</td> <td style="text-align: center;">4</td> <td style="text-align: center;">3</td> <td style="text-align: center;">2</td> <td style="text-align: center;">1</td> <td style="text-align: center;">0</td> </tr> <tr> <td style="text-align: center;">Learning</td> <td style="text-align: center;">Not used</td> <td colspan="6" style="text-align: center;">Scene number</td> </tr> </table> <p>Bit 7: 0: The scene is called / 1: The scene is saved. Bit 6: Not used. Bit 5 to Bit 0: Scene numbers from 0 (Scene 1) to 63 (Scene 64).</p> <p>For further information, see: Scene.</p>					7	6	5	4	3	2	1	0	Learning	Not used	Scene number					
7	6	5	4	3	2	1	0													
Learning	Not used	Scene number																		

4.2.4 Preset

No.	Name	Function of the object	Data type	Flags
9, 36, 63, 90, 117, 144, 171, 198	Output x	Preset 1	1 bit - 1.022 DPT_Scene_AB	C, R, W
<p>This object is activated if the Preset has value Active with preset 1-level object or Active with preset 2-level objects. With this object, several outputs can be set to a configurable predefined status.</p> <p>Object value:</p> <ul style="list-style-type: none"> - If the object receives value 0, the values of the parameters for Preset 1 = 0 are used. - If the object receives value 1, the values of the parameters for Preset 1 = 1 are used. <p>For further information, see: Preset.</p>				

No.	Name	Function of the object	Data type	Flags
10, 37, 64, 91, 118, 145, 172, 199	Output x	Preset 2	1 bit - 1.022 DPT_Scene_AB	C, R, W
<p>This object is activated if the Preset parameter has value Active with preset 2-level objects.</p> <p>See object No. 9</p>				

No.	Name	Function of the object	Data type	Flags
11, 38, 65, 92, 119, 146, 173, 200	Output x	Preset 1 authorization	1 bit - 1.003 DPT_Enable	C, R, W

This object is activated if the **Preset authorization objects** parameter is active.
 This object allows the authorization or lock-up of the Preset 1 function via a KNX telegram.
 Object value: This is dependent on the **Polarity of autorisation object Preset 1** parameter.

0 = Locked-up, 1 = Authorized:

- If the object receives the value 0, Preset 1 is deactivated.
- If the object receives the value 1, Preset 1 is activated.

0 = Authorized, 1 = Locked-up:

- If the object receives the value 0, Preset 1 is activated.
- If the object receives the value 1, Preset 1 is deactivated.

For further information, see: [Preset](#).

No.	Name	Function of the object	Data type	Flags
12, 39, 66, 93, 120, 147, 174, 201	Output x	Preset 2 authorization	1 bit - 1.003 DPT_Enable	C, R, W

See object No. 11

4.2.5 Lock-up

No.	Name	Function of the object	Data type	Flags
13, 40, 67, 94, 121, 148, 175, 202	Output x	Lock-up 1	1 bit - 1.003 DPT_Enable	C, R, W

This object is activated if the **Lock-up** has value **Active with 1 lock-up object** or **Active with 2 lock-up objects**.
 This object is used to control the activation of the lock-up via the KNX bus.
 Object value: This is dependent on the **Polarity of lock-up object 1** parameter.

0 = Lock-up activated, 1 = Lock-up deactivated:

- If the object receives value 0, the Lock-up is activated.
- If the object receives value 1, the Lock-up is deactivated.

0 = Lock-up deactivated, 1 = Lock-up activated:

- If the object receives value 0, the Lock-up is deactivated.
- If the object receives value 1, the Lock-up is activated.

For further information, see: [Lock-up](#).

No.	Name	Function of the object	Data type	Flags
14, 41, 68, 95, 122, 149, 176, 203	Output x	Lock-up 2	1 bit - 1.003 DPT_Enable	C, R, W

This object is activated if the **Lock-up** parameter has value **Active with 2 lock-up objects**.

See object No. 13.

No.	Name	Function of the object	Data type	Flags
15, 42, 69, 96, 123, 150, 177, 204	Output x	Status indication lock-up	1 bit - 1.011 DPT_Switch	C, R, T

This object is activated when the **Activation of lock-up status object** parameter is active. This object allows the status of the lock-up to be sent from the device over the KNX bus. Object value: Depends on the **Polarity** parameter.

0 = Lock-up deactivated, 1 = Lock-up activated:

- If the lock-up is deactivated, a telegram with logic value 0 is sent on the KNX bus.
- If the lock-up is activated, a telegram with logic value 1 is sent on the KNX bus.

0 = Lock-up activated, 1 = Lock-up deactivated:

- If the lock-up is activated, a telegram with logic value 0 is sent on the KNX bus.
- If the lock-up is deactivated, a telegram with logic value 1 is sent on the KNX bus.

This object is sent periodically and/or on status change.

For further information, see: [Lock-up](#).

4.2.6 Priority

No.	Name	Function of the object	Data type	Flags
16, 43, 70, 97, 124, 151, 178, 205	Output x	Priority	2 bit - 2.002 DPT_Bool_Control	C, R, W

This object is activated if the **Priority** parameter is active. The status of the output contact is determined directly by this object. Details on the format of the object are given below.

Telegram received by the priority operation object		Status of the outputs
Bit 1	Bit 2	
0	0	End of the priority
0	1	End of the priority
1	0	Priority OFF
1	1	Priority ON

The first bit of this object (Bit 0) determines the status of the output contact, which should be priority controlled. The second bit activates or deactivates the Priority.

For further information, see: [Priority](#).

No.	Name	Function of the object	Data type	Flags
17, 44, 71, 98, 125, 152, 179, 206	Output x	Status indication priority	1 bit - 1.011 DPT_State	C, R, T

This object is activated if the **Activation of priority status object** parameter is active.
 This object allows the status of the Priority to be sent from the device on the KNX bus.
 Object value: Depends on the **Polarity** parameter.

0 = Not forced, 1 = Forced:

- If Priority is deactivated, a telegram is sent with logic value 0.
- If Priority is activated, a telegram is sent with logic value 1.

0 = Forced, 1 = Not forced:

- If Priority is activated, a telegram is sent with logic value 0.
- If Priority is deactivated, a telegram is sent with logic value 1.

This object is sent periodically and/or on status change.

For further information, see: [Priority](#).

4.2.7 Alarm

No.	Name	Function of the object	Data type	Flags
18, 45, 72, 99, 126, 153, 180, 207	Output x	Alarm 1	1 bit - 1.005 DPT_Alarm	C, W

This object is only visible if the **Alarm** parameter has the following value: **1 alarm object** or **2 alarm objects** or **3 alarm objects**.

This object is used to switch the output back to the predefined settings.

Object value:

- If the object receives the value 0, the alarm is not activated.
- -If the object receives the value 1, the alarm is activated.

For further information, see: [Alarm](#).

No.	Name	Function of the object	Data type	Flags
19, 46, 73, 100, 127, 154, 181, 208	Output x	Alarm 2	1 bit - 1.005 DPT_Alarm	C, W

See object No. 18.

No.	Name	Function of the object	Data type	Flags
20, 47, 74, 101, 128, 155, 182, 209	Output x	Alarm 3	1 bit - 1.005 DPT_Alarm	C, W

See object No. 18.

No.	Name	Function of the object	Data type	Flags
21, 48, 75, 102, 129, 156, 183, 210	Output x	Alarm status indication	1 bit - 1.011 DPT_State	C, R, T

This object is activated when the **Alarm status object** parameter is active.
 This object allows the status of the alarm angle to be sent over the KNX bus.
 Object value: Depends on the **Polarity** parameter.

0 = Alarm deactivated, 1 = Alarm activated

- If all the alarms are deactivated, a telegram with logic value 0 is sent on the KNX bus.
- If one of the three alarms is activated, a telegram with logic value 1 is sent on the KNX bus.

0 = Alarm activated, 1 = Alarm deactivated

- If one of the three alarms is activated, a telegram with logic value 0 is sent on the KNX bus.
- If all the alarms are deactivated, a telegram with logic value 1 is sent on the KNX bus.

This object is sent periodically and/or on status change.

For further information, see: [Alarm](#).

4.2.8 Sun protection

No.	Name	Function of the object	Data type	Flags
22, 49, 76, 103, 130, 157, 184, 211	Output x	Sun protection position %	1 byte - 5.001 DPT_Scaling	C, R, W

This object is only visible if the **Sun protection type** parameter has the following value: **Objects position and slat angle** or **Position object only**.

It is used for positioning the shutter or blind at the desired height, in response to the value sent on the KNX bus.

As a general rule, this object is connected with an external device, which sends a position value to the shutter or blind in response to the elevation of the sun.

Object value: 0 to 255

- 0 (0%): Upper position
- 255 (100%): Lower position

For further information, see: [Sun protection](#).

No.	Name	Function of the object	Data type	Flags
23, 50, 77, 104, 131, 158, 185, 212	Output x	Slat angle (0-100%)	1 byte - 5.001 DPT_Scaling	C, R, W

This object is only visible if the **Sun protection type** parameter has the following value: **Objects position and slat angle** or **Slat angle object only**.

This object is used to position the shutter or blind in response to the value that is sent on the KNX bus.

As a general rule, this object is connected with an external device, which sends a slat angle value to the blind in response to the elevation of the sun.

Object value: 0 to 255

- 0 (0%): Slats open
- 255 (100%): Slats closed

For further information, see: [Sun protection](#).

No.	Name	Function of the object	Data type	Flags
24, 51, 78, 105, 132, 159, 186, 213	Output x	Sun protection authorization	1 bit - 1.003 DPT_Enable	C, R, W

This object is activated if the **Sun protection authorization** object parameter is active.
 This object allows the sun protection status of the alarm function of the device to be activated or deactivated over the KNX bus.
 Object value: Depends on the **Polarity** parameter.

0 = Locked-up, 1 = Authorized

- If the object receives the value 0, the sun protection is deactivated.
- If the object receives the value 1, the sun protection is activated.

0 = Authorized, 1 = Locked-up

- If the object receives the value 0, the sun protection is activated.
- If the object receives the value 1, the sun protection is deactivated.

For further information, see: [Sun protection](#).

No.	Name	Function of the object	Data type	Flags
25, 52, 79, 106, 133, 160, 187, 214	Output x	Sun protection reactivation	1 bit - 1.003 DPT_Enable	C, R, W

This object is activated if the **Deactivate sun protection by local control** parameter is active.
 This object is used to reactivate the sun protection of the device after a lock-up or at the end of a time-limited function, over the KNX Bus.

Object value:

- If the object receives the value 1, the sun protection is reactivated.
- If the object receives the value 0, the sun protection is permanently deactivated.

For further information, see: [Sun protection](#).

No.	Name	Function of the object	Data type	Flags
26, 53, 80, 107, 134, 161, 188, 215	Output x	Sun protection status	1 bit - 1.011 DPT_State	C, R, T

This object is activated when the **Sun protection status object** parameter is active.
 This object allows the status of the sun protection to be sent over the KNX bus.
 Object value: Depends on the **Polarity** parameter.

0 = Authorized, 1 = Locked-up

- If the sun protection is deactivated, a telegram with logic value 1 is sent on the KNX bus.
- If the sun protection is activated, a telegram with logic value 0 is sent on the KNX bus.

0 = Locked-up, 1 = Authorized

- If the sun protection is activated, a telegram with logic value 1 is sent on the KNX bus.
- If the sun protection is deactivated, a telegram with logic value 0 is sent on the KNX bus.

This object is sent periodically and/or on status change.

For further information, see: [Sun protection](#).

5. Appendix

5.1 Specifications

5.1.1 TYA624 A/C

Supply voltage	30 V DC SELV
Power dissipation	2W
Typical consumption on the KNX bus	5,2 mA
Standby consumption on the KNX bus	4,5 mA
Dimensions	4 x 17,5 mm
Operating temperature	-5 °C → + 45 °C
Storage temperature	- 20 °C → + 70 °C
Electrical connection	 0,75 mm ² → 2,5 mm ²
Breaking capacity	μ230 V~ 6A AC1
Maximum switching rate at full load	20 switching cycles/minute
Installation mode	DIN-rail
Operating altitude	< 2000 m
Pollution level	2
Surge voltage	4kV
Protection rating	IP 20 (housing) / IP30 (housing under faceplate)
IK	04
Overvoltage category	III
Standard	EN50491-3 ; EN60669-2-1

5.1.2 TYA624 B/D

Supply voltage	30 V DC SELV
Power dissipation	2 W
Typical consumption on the KNX bus	5,2 mA
Standby consumption on the KNX bus	4,5 mA
Dimensions	4 x 17,5 mm
Operating temperature	-5 °C → + 45 °C
Storage temperature	- 20 °C → + 70 °C
Electrical connection	 0,75 mm ² → 2,5 mm ²
Breaking capacity	μ 24V DC 6A DC1
Maximum switching rate at full load	20 switching cycles/minute
Installation mode	DIN-rail
Operating altitude	< 2000 m
Pollution level	2
Surge voltage	4 kV
Protection rating	IP 20 (housing) / IP30 (housing under faceplate)
IK	04
Overvoltage category	III
Standard	EN50491-3 ; EN60669-2-1

5.1.3 TYA628 B/D

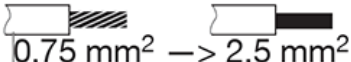
Supply voltage	30 V DC SELV
Power dissipation	2 W
Typical consumption on the KNX bus	15,8 mA
Standby consumption on the KNX bus	8,8 mA
Typical consumption KNX bus with the mains	2 mA
Standby consumption KNX bus with the mains	2 mA
Dimensions	6 x 17,5 mm
Operating temperature	-5 °C → + 45 °C
Storage temperature	- 20 °C → + 70 °C
Electrical connection	 0,75 mm ² → 2,5 mm ²
Breaking capacity	μ230 V~ 6A AC1
Maximum switching rate at full load	20 switching cycles/minute
Installation mode	DIN-rail
Operating altitude	< 2000 m
Pollution level	2
Surge voltage	4 kV
Protection rating	IP 20 (housing) / IP30 (housing under faceplate)
IK	04
Overvoltage category	III
Standard	EN50491-3 ; EN60669-2-1

5.1.4 TYM632C

Supply voltage KNX	DC 21...32 V SELV
Own consumption on the KNX bus:	
--typical	7 mA
--in standby	5 mA
Auxiliary voltage	230 V AC, + 10 % .. - 15 % 240 V, + 6 % .. - 6%
Mains frequency	50/60 Hz
Energy dissipation	3 W
Own consumption on mains:	
--maximum	5 W
--in standby	0,2 W
Breaking capacity	μ230 V, 6 A AC1
Switching current at cos Φ = 0.8 max.	4 A
Operating altitude max,	2000 m
Degree of contamination	2
Surge voltage	4 kV
Degree of protection of housing	IP 20
Degree of protection of housing under front panel	IP30
Impact protection	IK 04
Overvoltage class	III
Operating temperature	-5° ... +45°C
Storage/transport temperature	-20° ... +70°C
Maximum switching cycle rate at full load	
switching cycle/minute	6
Connection capacity	0,5 mm ² ...6 mm ²
Standards	EN50491-3 ; EN60669-2-1
Dimension 10 TE,	10 x 17,5 mm

5.2 Table of logical operations

Input 4	Input 3	Input 2	Input 1	OR	AND
-	-	0	0	0	0
-	-	0	1	1	0
-	-	1	0	1	0
-	-	1	1	1	1
-	0	0	0	0	0
-	0	0	1	1	0
-	0	1	0	1	0
-	0	1	1	1	0
-	1	0	0	1	0
-	1	0	1	1	0
-	1	1	0	1	0
-	1	1	1	1	1
0	0	0	0	0	0
0	0	0	1	1	0
0	0	1	0	1	0
0	0	1	1	1	0
0	1	0	0	1	0
0	1	0	1	1	0
0	1	1	0	1	0
0	1	1	1	1	0
1	0	0	0	1	0
1	0	0	1	1	0
1	0	1	0	1	0
1	0	1	1	1	0
1	1	0	0	1	0
1	1	0	1	1	0
1	1	1	0	1	0
1	1	1	1	1	1

5.3 Characteristics

Device	TYA624A/B/C/D	TYA628A/C	TYM632C
Max. number of group addresses	254	254	500
Max. number of allocations	255	255	500
Objects	153	193	343

