

Manual

Floor installation systems

Basic knowledge

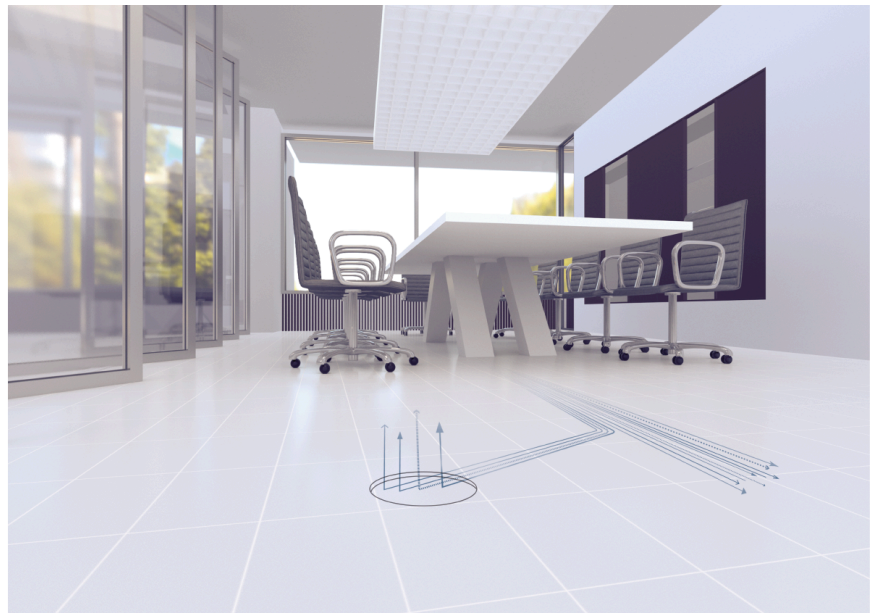

Table of contents

1	Basic planning principles.....	17
1.1	Requirements for installation technology.....	17
1.2	Requirements from building conception.....	17
1.3	Requirements for organisation.....	18
1.4	Requirements for security.....	18
1.5	Installation requirements / construction requirements.....	18
2	Trunking systems.....	19
2.1	Screed-covered trunking system.....	19
2.2	Screed-flush trunking systems.....	20
2.3	On-floor trunking system.....	22
2.4	Raised floor installation system.....	23
2.5	Cavity floor installation system.....	24
3	Basic principles of screed.....	25
3.1	Screed structure.....	25
3.2	Screed work.....	26
3.3	Screed types.....	26
4	Floor structure.....	28
4.1	Floor structure 50 mm.....	28
4.2	Floor structure 75 mm.....	29
4.3	Floor structure 105 mm.....	29
5	Information on the floor covering and for the floor layer.....	30
5.1	Information on the floor covering.....	30
5.2	Information for the floor layer.....	30
6	Determining the cable volume.....	32
6.1	Bend radii.....	33
6.2	Cable volume of most common installation cables.....	34
7	Power supply and device installation units.....	37
7.1	Stainless steel cassette EKQ/EKR/EKSQ/EKSR.....	38

8	IP degree of protection.....	43
9	IK degree of impact resistance.....	45
10	Mechanical/thermal loads.....	46
11	Standardisation and testing.....	47
12	Erector specifications.....	50
12.1	Protection against electric shock.....	50
12.2	Mechanical load of cables.....	51
12.3	Separation of different services.....	51
12.4	Fire protection.....	51
13	Equipotential bonding.....	52
14	Inter-unit working.....	53
14.1	Inter-unit working - Screed work.....	53
14.2	General information for screed layers.....	53
14.3	Inter-unit working - Floor covering work.....	53
14.4	Inter-unit working - Building cleaning.....	53
15	Sound protection and impact noise.....	55
15.1	Impact noise reduction for floor installation systems.....	55
16	Appendix.....	56
16.1	Overview of floor installation systems - cable assignment.....	56
16.2	Reference sources of standards and specifications.....	63

FAQs

7 questions - 7 answers

To meet all the requirements during the planning phase, you should get to grips with these **7 questions**. This ensures that you will obtain the right trunking system solution for your construction project. The answers to your questions will provide you with the right solution for your construction project. Starting with the right trunking system, the screed height, the floor coverings and their care through to the installation units.

Question 1: Which floor installation system is to be used?

- Screed-covered floor system
- Screed-flush floor system
- On-the floor system
- Cavity floor system
- Raised floor system

Question 2: How is the cable volume calculated?

Cable volume calculation (d^2)

- Data/communication technology
- Multimedia technology
- Energy technology

Question 3: How high is the planned floor structure?

- Nominal screed thickness, incl. possible insulation layers
- Thickness of floor covering

Question 4: Which floor covering will be laid?

- Parquet
- Vinyl
- Linoleum
- Tiles/granite
- Carpet

Question 5: How will the floor covering be cleaned?

- Dry/moist cleaned
- Wet cleaned

Question 6: What are the maximum mechanical stresses that can occur?

- Standard
- Drive-over
- Heavy-duty

Question 7: Which supply and installation units are required?

- Size
- Number of installable devices
- Shape
- Material

Answer 1: Which floor installation system is to be used?

A distinction is made between 5 standard floor systems. The appropriate floor system sets the course from the very start. Depending on the system, only certain products may be used. Whether this is a screed-covered trunking system, which is often used in new buildings, or an on-floor trunking system, which is often used during renovations. The rough direction is entirely different. Specific solutions and combination options are available for each system.

Using these aspects, it is possible to make a rough selection of the right trunking system.

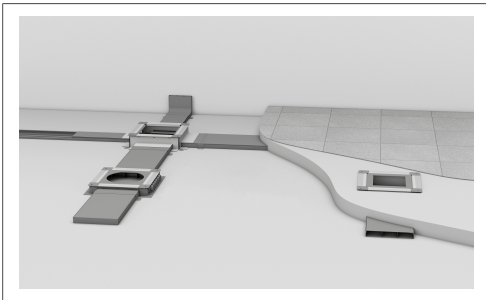
Screed-covered trunking system

The screed-covered trunking system is suitable for all types of screed. No matter whether composite cement, floating screed, flowing screed or, with special precautions, also mastic asphalt / hot floor screed. The screed-covered trunking system can be used in residential and functional buildings.

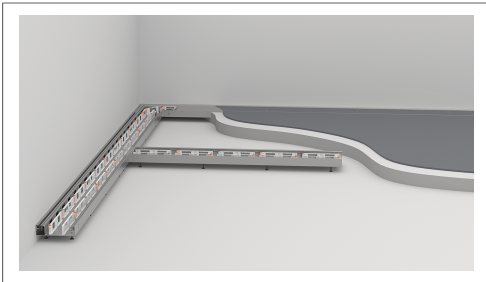
Screed-flush trunking systems

The screed-flush trunking system makes energy, data and communication connections available around the room. Besides its adaptability to state-of-the-art technology, it is also open to any form of interior design: It can be assigned with all kinds of dry cleaned floors. Here, the height adjustment, which is accurate to the millimetre, can offer a 'smooth' end - whilst the comprehensive range of fittings adapts exactly to any angle.

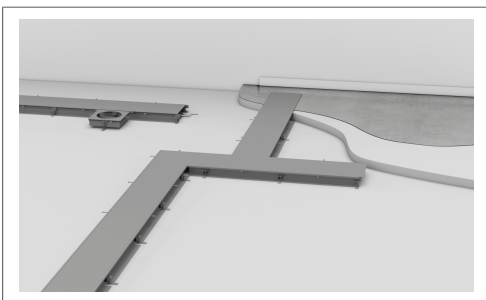

This height-variable system is used anywhere where it is not clear how the 'final installation' will be and/or the highest level of flexibility is desired. Trunking widths of up to 600 mm allow the trunking to be used wherever high volumes of cables occur. The shiny version of the screed-flush trunking is used in production halls and in office and administration buildings. Its very low height means that the trunking is also suitable for very flat screed heights of 30 mm or more.

On-floor trunking system

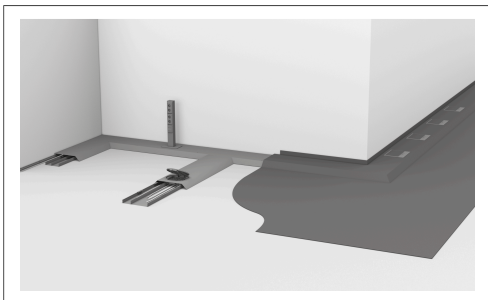

This trunking system is particularly suitable for renovations of old buildings and the modernisation and expansion of building installations. The main areas of use are renovations of office and administration buildings, as well as construction projects requiring the rapid erection of electrical systems on already completed floors. If it is not possible to install underfloor trunking in the screed due to building protections on static or monument protection grounds, then the on-floor trunking are routed on the floors. The robust on-floor trunking is also used in assembly facilities, laboratories or industrial buildings.

Raised floor system

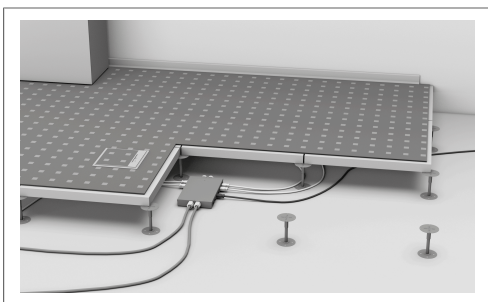

Open plan offices or large-area call centres divided up into many computer workstations using partitions and which must remain structured cannot avoid this flexible system. This also applies to computer server rooms constructed with raised floors, which offer the greatest possible flexibility through their construction. In this way, completely networked power and data networks are integrated into showrooms or trade fair stands which are rebuilt according to requirements.

Cavity floor system

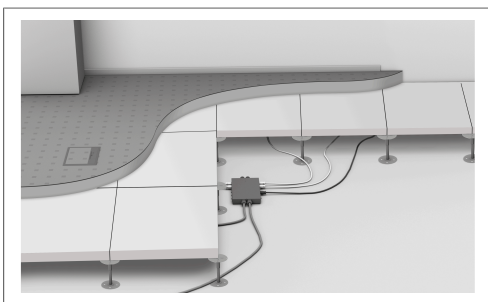

In cavity floors, prefabricated lined bodies are laid out on the raw ceiling and then cast with screed. In contrast to raised floor systems, in which individual plates can be exchanged as required, a cavity floor is a closed screed plate on stilts. In a similar manner to the raised floor system, wiring can be designed very flexibly using plug and play systems.

Answer 2: How is the cable volume calculated?

The cable volume is required to define the correct duct size. However, as, in practice, cables can never lay next to each other in a perfectly parallel and space-saving manner, the formula $(d)^2$ or the diameter squared is used. The trunking should only be 50 % full, to leave space for possible refitting later on. This means that the cables can also be pulled through the trunking more easily.

In addition, it should be noted that, in this calculation, no floor tanks or outlets which might interrupt the cable path are taken into account. In practice, power and data cables are routed separately in the trunking. Separating webs divide the trunking up into multiple compartments. If this applies, then the space requirements must be calculated for each compartment individually.

With stronger current loads of the cables, cable heating should be taken into account. In addition, all the relevant regulations, such as DIN VDE 0100, must also be taken into account.



Answer 3: How high is the planned floor structure?

The height of the planned underfloor system also has a key role to play in the planning and installation of underfloor cable systems. In particular, with screed-covered floors and screed-flush floor systems, this information is used to include the appropriate elements for height adjustment into the planning and installation. Different products and solutions are used, depending on the height.

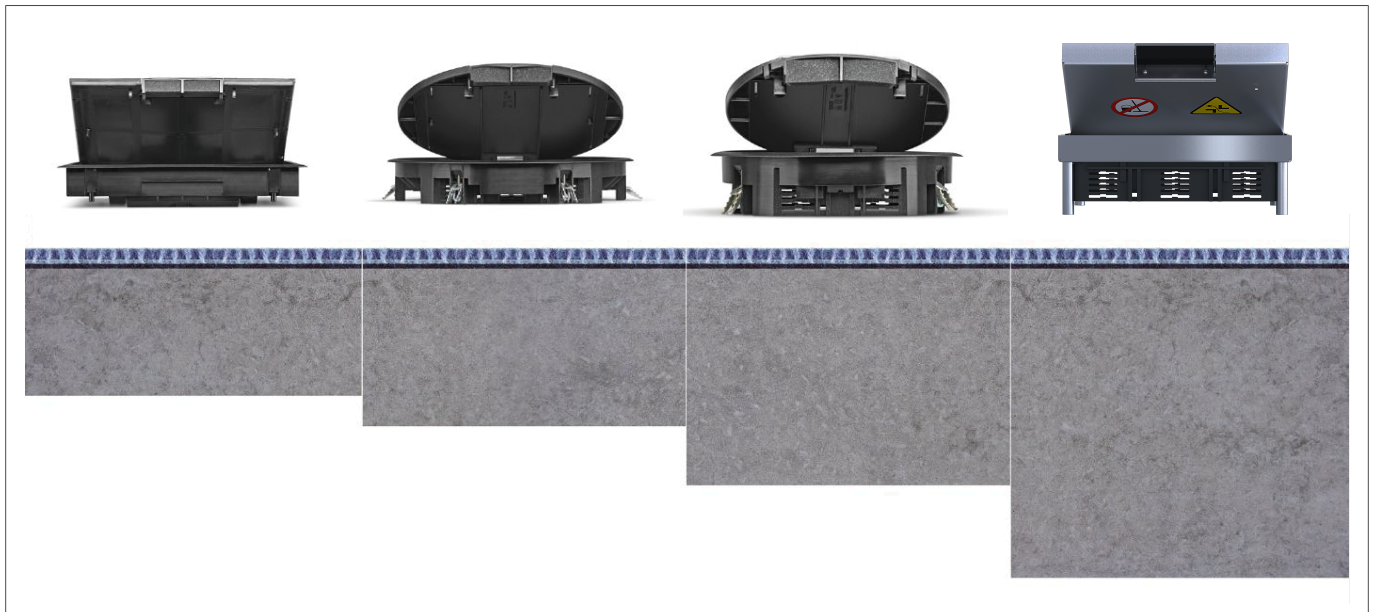

Information

In general, the prescribed floor structure specifies the area available for the floor solution.

- Hinged cover with ultra-flat installation depth for a floor structure of 50 mm or more
- Standard supply units with floor covering recesses of 5 mm for a floor structure of 75 mm or more
- Standard supply units with floor covering recesses of 12 mm for a floor structure of 85 mm or more
- Stainless steel cassettes for a floor structure of 95 mm or more

Answer 4: Which floor covering will be laid?

Often, the floor covering is specified in a construction project. It is stated whether there will be a carpeted floor, laminate, parquet, tiles, stone, PVC or a linoleum covering. Each covering has a different height. This means that not every covering fits in every installation unit. Three different heights are available here. Supply units are available for smaller covering heights up to 5 mm or up to 12 mm and stainless steel cassettes are available for heights of up to 23 mm.

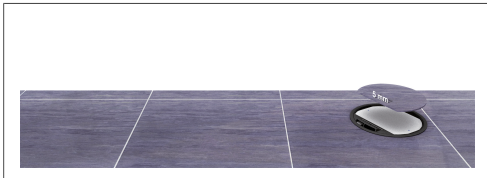

PVC coverings are often only 3 to 4 mm thick. For such coverings, and for thin carpets and linoleum, standard supply units with a 5 mm frame height are ideal.

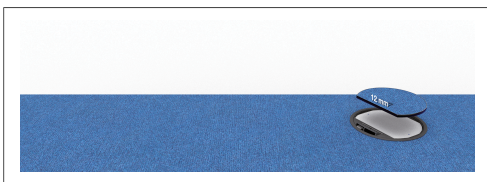

Carpeted floors and laminate generally have a thickness of 8 to 10 mm, whilst some laminate types with adhesive are thicker still. Here, standard frames of 10 mm height are insufficient. Therefore, Hager offers, as the sole provider, standard supply units with a 12 mm frame height. If the frame is too high, then cover inlays of 1 to 2 mm can be inserted to support the floor covering.



For coverings such as parquet or stone tiles, Hager can offer stainless steel cassettes with a base recess of up to 23 mm or up to 38 mm, according to the version. Even with very thick floor coverings, this guarantees tidy work without bumps and dips.

Answer 5: How will the floor covering be cleaned?

The cleaning category is aligned to the type of floor covering. Carpeted floors are usually dry cleaned, whilst tiles are normally moist or wet cleaned.

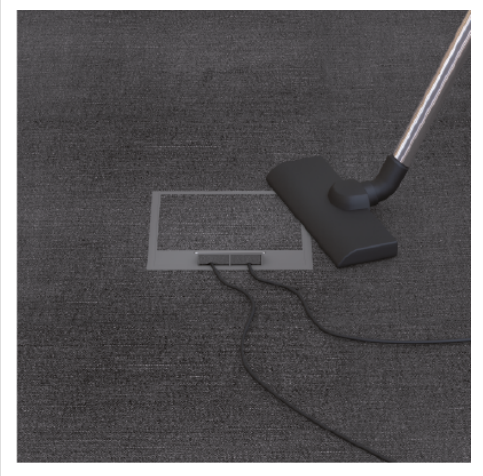

Dry cleaned and 'moist cleaned' floors

Floor coverings that can be vacuumed (e.g. carpeted floors) or those which can be wiped over with moist but not wet cleaning devices (e.g. laminate) are combined as 'dry cleaned floors'. All the standard supply units, cable outlets and pedestals from Hager can be used on such floors.



Wet cleaned floors

Floors subject to serious degrees of contamination - such as stone floors in factory halls - must be wet cleaned using liquid cleaning agents. For these 'wet cleaned floors', Hager can offer 'water-tight' system components, such as supply units with integrated water stream protection, which is offered in either aluminium or polyamide.

Answer 6: Which mechanical stresses can occur?

Different load requirements occur, depending on the circumstances. In everyday office life, mechanical stresses of up to 1500 N will generally occur. However, in public buildings, such as airports or stations, this amount is usually incorrect. Daily work with luggage carts, cleaning machines or mobile scaffolding increases the load. The ability to be driven on is often also a condition in car or other showrooms. In assembly halls or warehouses, the mechanical stress is frequently greatly increased by loaded forklifts or trucks.

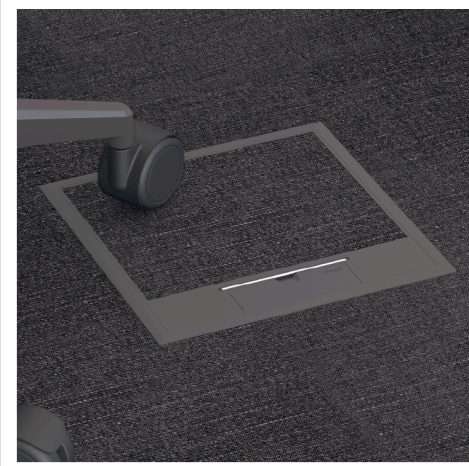
**1500 N Standard**

All the supply units and stainless steel cassettes are designed according to the standard for a mechanical stress of 1500 N. These include all the supply units, all the stainless steel cassettes, screed-flush trunking, on-floor trunking, etc. This is fully sufficient for the normal mechanical stresses of everyday office life.

**7500 N drive-on****VANR12 supply unit**

The VANR12 supply unit is designed for increased mechanical stresses. The supply unit is made of aluminium and can be driven over in a car.

**20000 N heavy duty**

The EKSQ405xx heavy duty cassette is used in car showrooms. This stainless steel cassette is supported by a solid heavy duty frame, thus offering sufficient stability for extremely high mechanical stresses.

Answer 7: Which installation units are required?

Supply and installation units

To supply commercial buildings in a sensible manner, it is wise not to cut corners - with regards to both energy and also information and data. The electraplan supply and installation units. VE-EEs can cover any customer requirements. They are compatible with almost any electraplan floor installation system and can be equipped with six to twelve connector boxes, according to requirements. The supply units are available in a range of materials, shapes and colours. Each device casing can be equipped variably: With protective contact sockets or support bar devices for network and multimedia technology.

Polyamide supply unit



The standard material for supply units is polyamide. Polyamide frames can withstand a load of up to 3 kN (DIN specification) - ideal for classic floor use. Large selection for use with 6, 9, 10 or 12 socket outlets.



Aluminium supply unit



In conjunction with high-quality floor coverings - e.g. stone tiles - it is wise to use aluminium supply units. They are not only more stable, but also provide a more elegant floor appearance. Hager can offer aluminium units that can withstand mechanical stresses of up to 7.5 kN for strong loads in public buildings - e.g. showrooms, stations or airports. Sizes: 2 sizes for use with 6 or 12 sockets, for example.

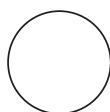

Stainless steel supply units



Stainless steel supply units are particularly robust: They correspond to the DIN mechanical stress specifications of 3 kN. As a heavy duty cassette, they can even withstand mechanical stresses of up to 20 kN (see Page 48). A further advantage: Thanks to their thin edge, they are barely noticeable in the floor - if they are, then its due to their fine appearance. Sizes: 2 sizes for use with 6 or 12 sockets, for example.



Basic knowledge

Important note

This document explains the relevant principles for the installation of floor installation systems and routing cables in these systems.

The contents of this document are based on the currently applicable rules and regulations as well as our own test findings. No generally applicable legal obligation shall be derived from the contents of this document.

1 Basic planning principles



Fig. 1: Planning

1.1 Requirements for installation technology

When planning and selecting the floor installation system, the following points must be observed with regard to the installation system requirements:

- Number of services (power, communication, data, multimedia)
- Filling factor of the electrical installation trunking
- Cable bend radii
- Reserve
- Concurrence factors
- Intended for indoor areas

1.2 Requirements from building conception

The following preconditions are to be taken into account on account of the use profiles of the individual rooms or the overall building:

- Type of room (dry or wet)
- Floor covering version (dry or wet cleaned)
- Thickness of the floor covering
- Type and version of the screed
- Traffic loads
- Ambient temperature (interior, e.g. underfloor heating)

1.3 Requirements for organisation

Areas of use and the specifications of the customer regarding installation technology (power, data, communication, multimedia) must also be taken into account during the planning of a floor installation system:

- Flexibility of use (e.g. light adjustment to changing use specifications)
- Easy changing of device equipment
- Use of fixed or portable installations

1.4 Requirements for security

Security and unauthorised access by third parties play an increasingly important role in the planning and selection of a floor installation system. Therefore, in data infrastructure areas (e.g. computer centres), particular attention must be placed on security, which must be taken into account during planning.

1.5 Installation requirements / construction requirements

To be able to begin with the installation of a floor installation system, the following conditions must be fulfilled:

- Approved and dimensioned routing plan, which specifies the position of all installation parts
- Project parts list with the materials to be used
- Information on the floor structure and floor covering
- A swept and approved raw construction ceiling in accordance with DIN 18 202 (tolerances in building construction)
- Cutting check data as reference point for the appropriate screed height
- Data on the traffic loads, fire protection measures and the impact noise
- Installation area must be free of rubble and outside materials
- There must be guaranteed protection against the influence of weathering and moisture
- Details on the minimum installation depth and floor cleaning of the installation units must be available

2 Trunking systems

A distinction is made between 5 standard floor systems. The appropriate floor system sets the course from the very start. Depending on the system, only certain products may be used. Whether this is a screed-covered trunking system, which is often used in new buildings, or an on-floor trunking system, which is often used during renovations, the rough direction is entirely different. Specific solutions and combination options are available for each system.

The following points, defined in the planning phase, are of decisive importance for the correct selection of the right trunking system:

- Building type (office/administrative building, car showrooms, etc.)
- Building substance (new building, old building with/without protection)
- Building structure (single or open plan offices)
- Use practices (flexible for changes of use)

2.1 Screed-covered trunking system

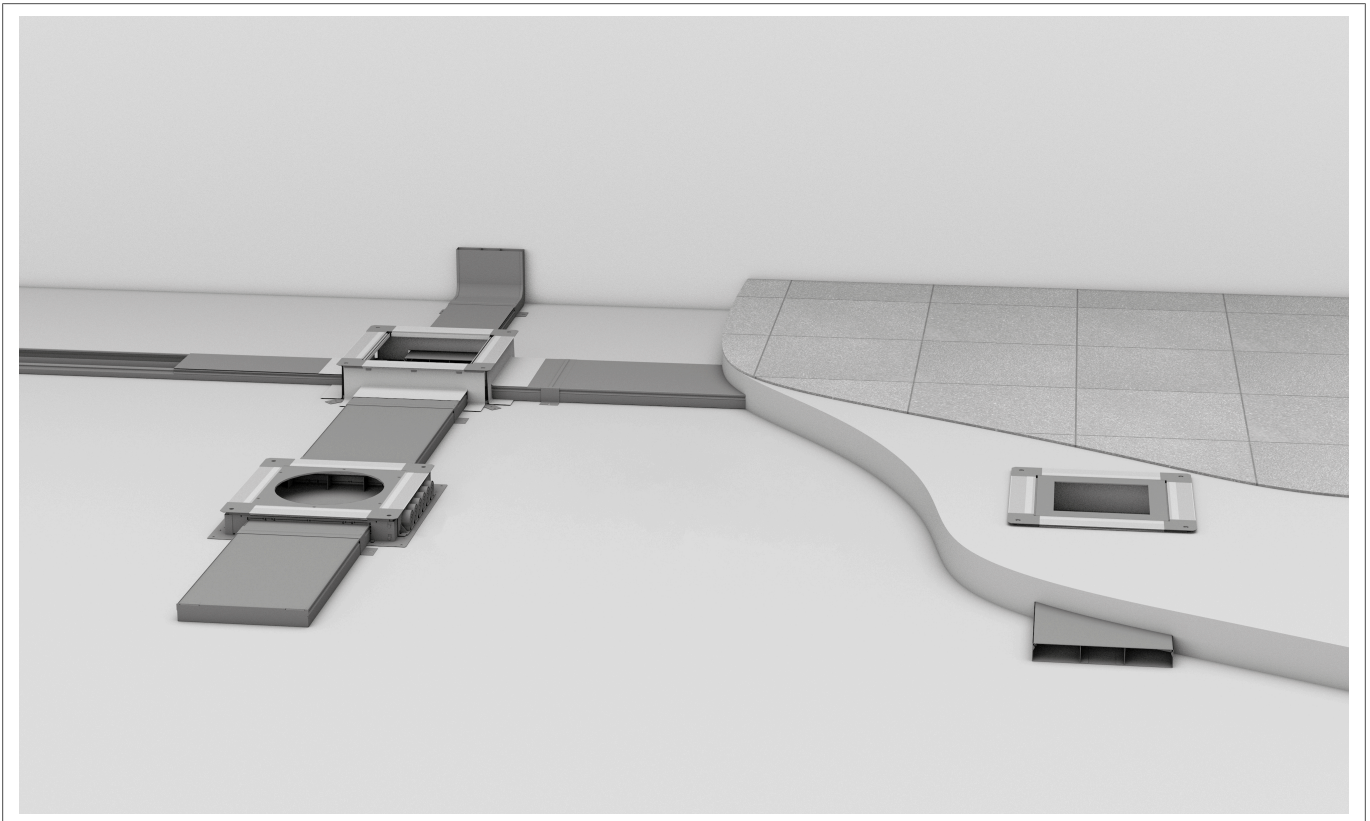

Fig. 2: electraplan.UK screed-covered trunking system

The electraplan.UK floor installation system is quick and easy to install and is suitable for virtually all types of screed. The underfloor trunking and floor boxes made from galvanised sheet steel, which offers optimal protection against corrosion, are secured to the bare floor. Since the upper sections of the basic profile are detachable, the cables can be placed into the trunking from above and do not need to be pulled in. The screed is administered flush with the upper edge of the floor boxes such that the underfloor trunking is covered. See catalogue!

2.2 Screed-flush trunking systems



Fig. 3: tehalit.BKB / tehalit.BKG screed-flush trunking systems

The screed-flush tehalit.BKB makes energy, data and communication connections available around the room. Besides its adaptability to state-of-the-art technology, it is also open to any form of interior design: It can be assigned with all kinds of dry cleaned floors. Here, the height adjustment, which is accurate to the millimetre, can offer a 'smooth' end - whilst the comprehensive range of fittings adapts exactly to any angle.

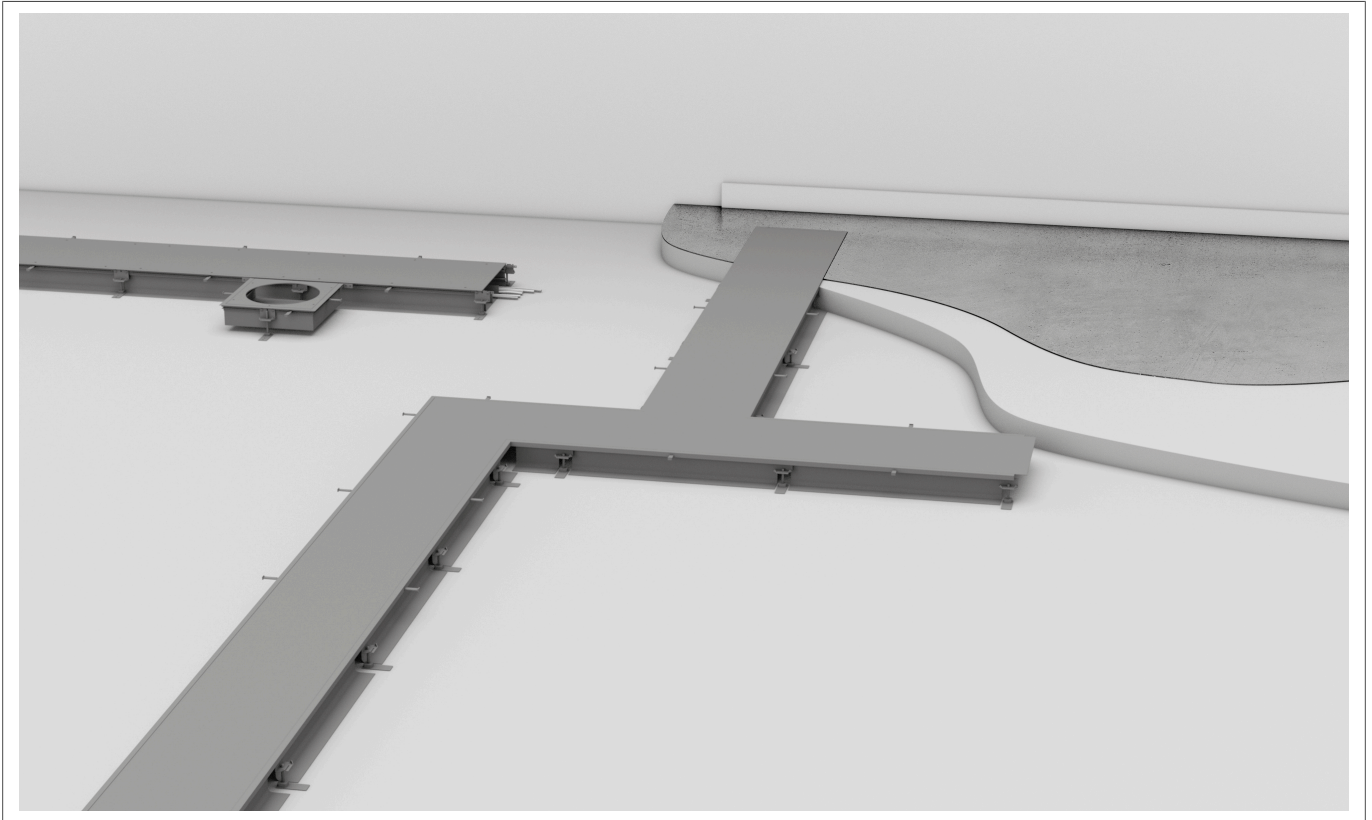

Fig. 4: electraplan.BK screed-flush trunking systems

This height-variable system is used anywhere where it is not clear how the ‘final installation’ will be and/or the highest level of flexibility is desired. Trunking widths of up to 600 mm allow the trunking to be used wherever high volumes of cables occur. This screed-flush trunking is used in a shiny version in production halls, but also in office and administrative buildings with trunking covers with floor covering stuck on. Its very low height means that the trunking is also suitable for very flat screed heights of 30 mm or more.

2.3 On-floor trunking system

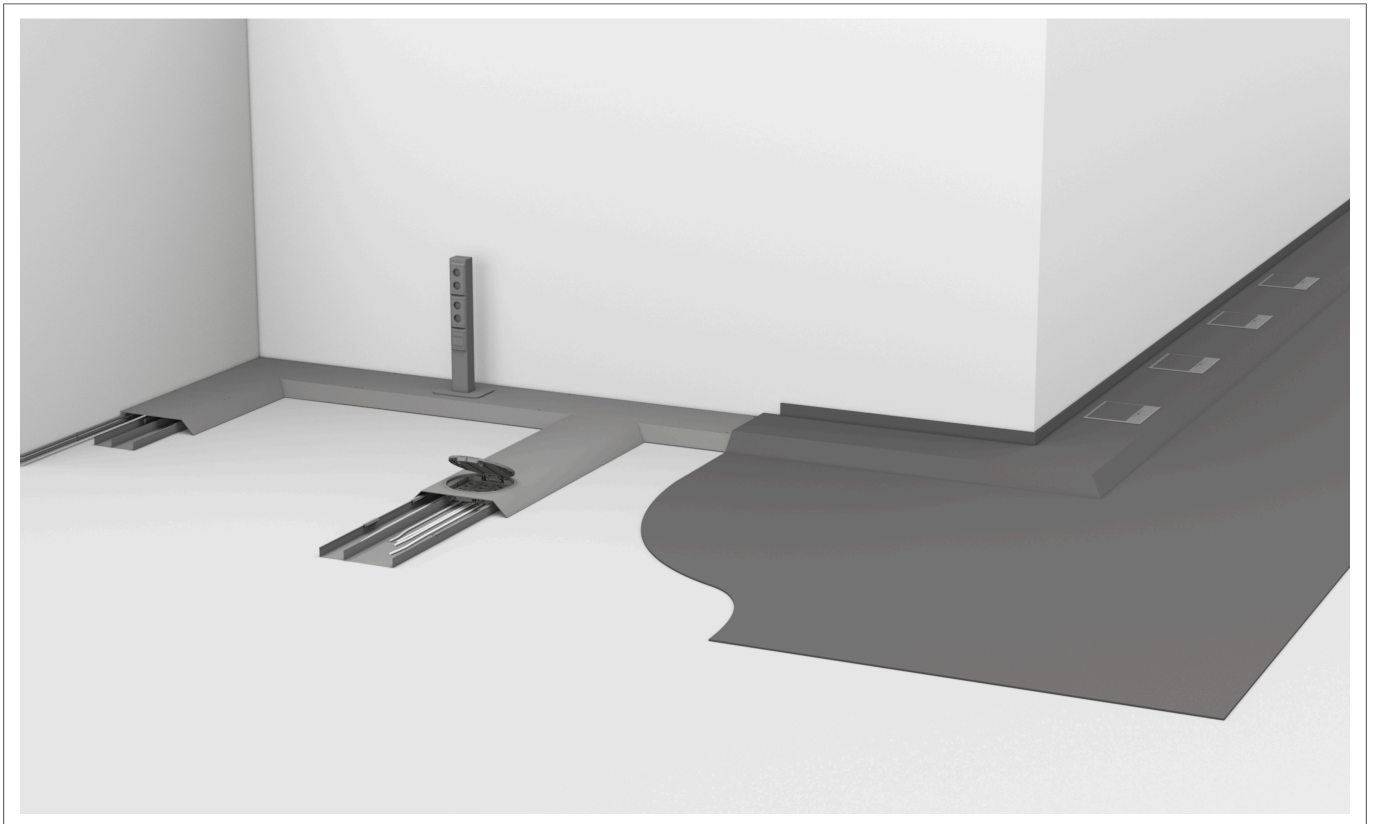

Fig. 5: electraplan.AK on-floor trunking system

For renovated properties or listed buildings, on-floor trunking is the perfect solution. Thanks to the range of moulded parts available for it, the electraplan.AK system is easy to assemble. Blind covers are screwed to the lower sections of the trunking; these blind covers are angled towards the floor and flooring can be laid over them. Installation apertures in the cover allow installation units, supply units, floor connection columns or on-floor pedestals to be installed. See catalogue!

2.4 Raised floor installation system

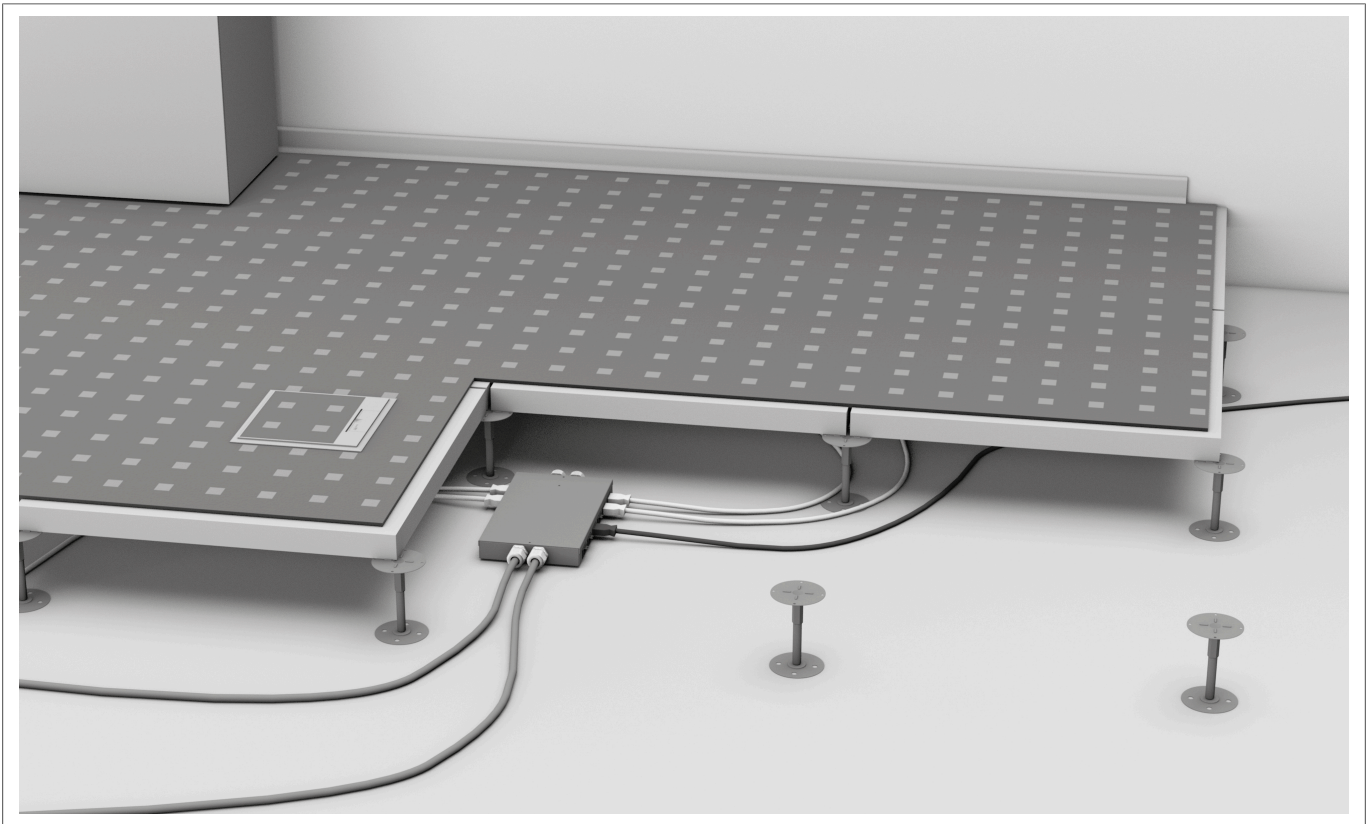

Fig. 6: electraplan.DB raised floor installation system

Open plan offices or large-area call centres divided up into many computer workstations using partitions and which must remain restructurable cannot avoid this flexible system. This also applies to computer server rooms constructed with raised floors, which offer the greatest possible flexibility through their construction. In this way, completely networked power and data networks are integrated into showrooms or trade fair stands which are rebuilt according to requirements.

2.5 Cavity floor installation system

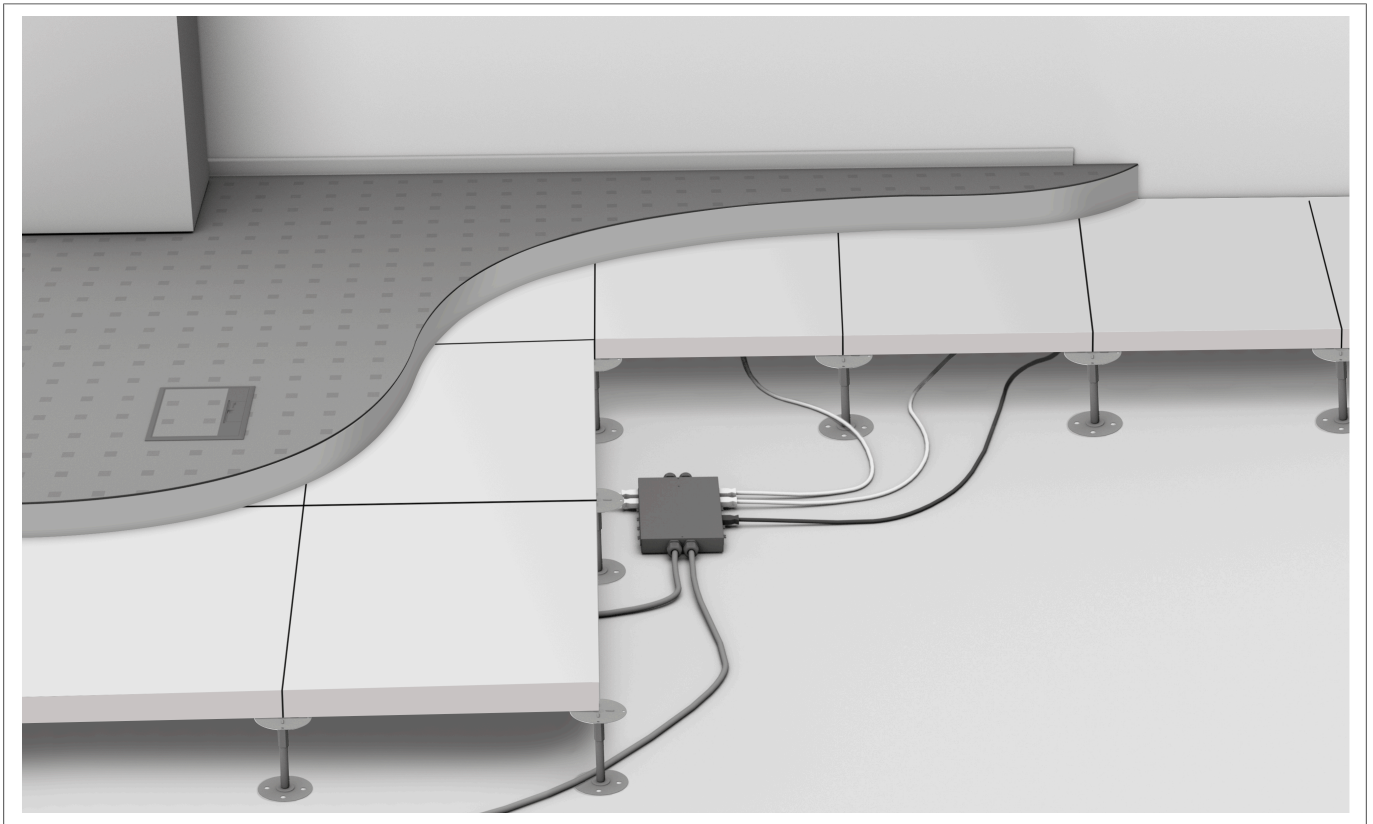

Fig. 7: electraplan.HB cavity floor installation system

In cavity floors, prefabricated polystyrene or plastic shells are laid out on the raw ceiling and then cast with screed. In contrast to raised floor systems, in which individual plates can be exchanged as required, a cavity floor is a closed screed plate on stilts.

In a similar manner to the raised floor system, wiring can be designed very flexibly using plug and play systems.

3 Basic principles of screed

3.1 Screed structure

The screed structure is a key precondition for the correct installation of underfloor systems. With screed-covered floor systems, it is essential that the screed thickness above the trunking corresponds to the value stated in the standard, in order to avoid crack formation.

The screed is located above the load-bearing storey ceiling or above the floor plate and beneath floor covering.

The nominal screed thickness is dependent on the insulating layer, the individual load and the screed type. Refer to DIN EN13813 for more information on the nominal screed thickness.

The minimum nominal thickness¹ is regulated according to the hardness class (DIN EN 13813) for perpendicular payloads $\leq 2 \text{ kN/m}^2$.

Under some circumstances, chemical or thermal loads may occur, which require additional measures to protect the installed system.

The electraplan.BK screed-flush duct systems and the BKSA underfloor sockets only receive their load capacity for correct use through being joined with the adjacent screed.

For this reason, the following points are important and must be observed:

- After the trunking system has been permanently installed on the raw concrete, then the system may no longer be walked on or subjected to similar loads
- The trunking system must form a composite system with the adjacent screed

With electraplan.BK, the following points must be particularly observed:

- The side profiles need to be supported with screed, in order to achieve a good static support in the screed. The screed is to be carefully worked and compacted
- The opened duct system may neither be walked on nor subjected to similar loads. Measured for the necessary protection must be taken in agreement with the construction management

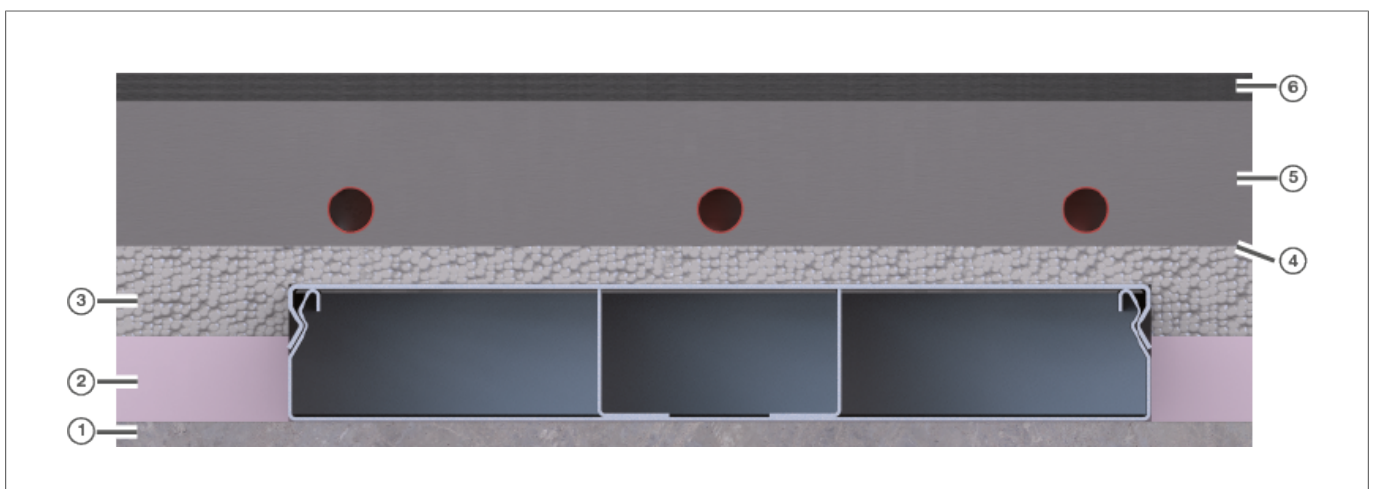

Fig. 8: General floor structure

- ① Raw ceiling / concrete plate
- ② Thermal insulation (e.g. polystyrene)
- ③ Impact noise insulation

¹ For greater payload and surface loads, appropriately higher minimum nominal thicknesses apply

- ④ PE film
- ⑤ Cement screed with underfloor heating
- ⑥ Floor covering

3.2 Screed work

Trunking and accessory parts only obtain their full load capacity for correct use through the fixed composite with the screed. For this, the following preconditions are of importance:

- The trunking system must be sealed before screed is applied
- All the system elements are permanently anchored on the raw ceiling
- The installed duct system may neither be walked on nor subjected to any other loads
- Any hollow spaces created must be filled with screed
- The trunking system may only be subjected to loads after the screed has hardened and must be blocked off prior to this
- Screed deformations and shrinkages must be observed in advance

With screed-covered trunking, it is essential that the screed thickness above the trunking corresponds to the value stated in the standard, in order to avoid crack formation.

The nominal screed thickness is dependent on the insulating layer, the individual load and the screed type. For more detailed information on screed types and the nominal screed thickness, refer to DIN EN 13318, DIN EN 13813, DIN EN18560. Here, under certain circumstances, chemical or thermal impacts may occur, which may require additional measures to protect the installed system.

Screed-flush trunking (BKF/D and BKW/D) and floor boxes (UDHx, UDBx, UDSx) must be levelled to the intended height before screed laying (construction side height line). The screed layer should check the levelling height.

Smooth and compress screed well on the screed-flush trunking and floor boxes (no insulating strip). Only this achieves the required load capacity.

The BKB/BKG screed-flush trunking system is decoupled from the screed using an insulating strip, as it could otherwise lead to damage to the screed and/or floor covering.

3.3 Screed types

When selecting the screed structure, it is necessary to clarify which screed mortar types are possible for the application. There are difference types of screed mortars.

Flowing screed:

Before screed application, these tasks must be observed and completed:

- The trunking system and boxes are to be weighed down →Floating of the screed
- The trunking system and boxes are to be sealed against the ingress of flowing screed and protected on the construction side
- Side profiles and film must be covered with sufficient screed
- Avoid cavities

Aggressive screed:

When using aggressive screed types, all the metal parts must be insulated during construction using a chloride and alkali-free bitumen layer or other suitable means (VOB Part C).

Corrosion:

Corrosion on metallic underfloor components is reduced to a minimum when ...

- The maximum moisture content of screeds corresponds to DIN EN 1264-4.
- Underfloor ducts are ventilated sufficiently for drying.

Hot floor screed:

Screed-flush trunking systems and boxes may not come into direct contact with the hot screed mass. With film lining, there must be an approx. 10 cm-thick layer of cement screed, for example, by the components for heat insulation. With metal lining and floor troughs, waterproofed corrugated card, for example, can be used for insulation. Screed-covered ducts must be protected against the hot screed mass with 2 - 3 layers of waterproofed corrugated card.

**Note!**

Avoid cavities!

Hager is not liable for any damaged cause by improper installation on the duct system or the floor box in conjunction with hot screed!

Expansion pressure of the screed plate:

According to the size of the screed plate and the composition of the screen, it is possible that the boxes may press against the electraplan.BK duct whilst the screed is hardening. For this, Hager can offer a matching self-adhesive foam rubber strip (BKZM203), which is fitted in the upper profile area, in order to reduce the expansion pressure of the screed plate on the duct. The use of the foam rubber strip must be agreed with the screed layer.

4 Floor structure

A decisive criterion in the correct selection is the floor structure. The screed height specifies the amount of play for the underfloor installation. Different products and solutions are used, depending on the height. It is ever often the case that the screed height is even thinner for reasons of cost. Hager can offer a range of finished solutions for this. However, should the screed height be extremely low, then special, project-related special solutions can be provide assistance here.



Fig. 9: Floor structure

4.1 Floor structure 50 mm

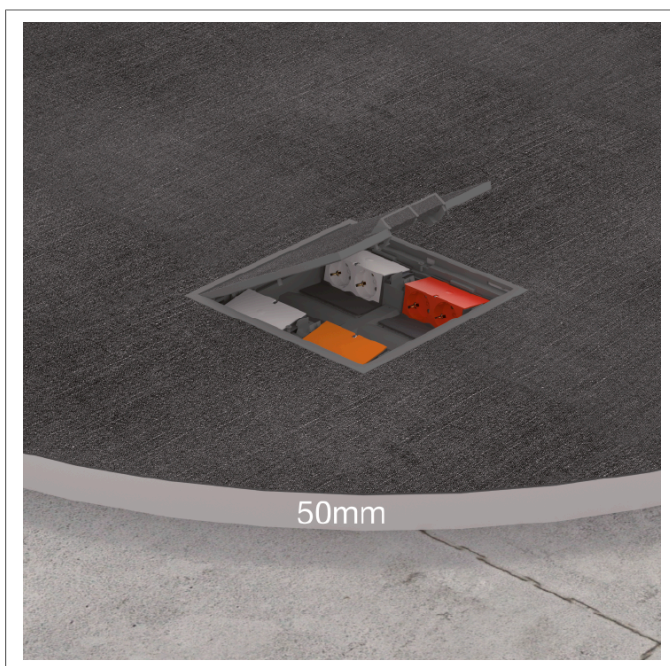

Fig. 10: Floor structure 50 mm

The two hinged covers KDQ08x and KDE04x were developed specially for the requirements, in which only a screed height of 50 mm or more is available.

Thanks to their horizontally arranged socket outlets in the GBES2x device casing, the hinged covers are suitable anywhere where the screed height is only very low. Special solutions can also be used to install data technology in the two hinged covers.

4.2 Floor structure 75 mm

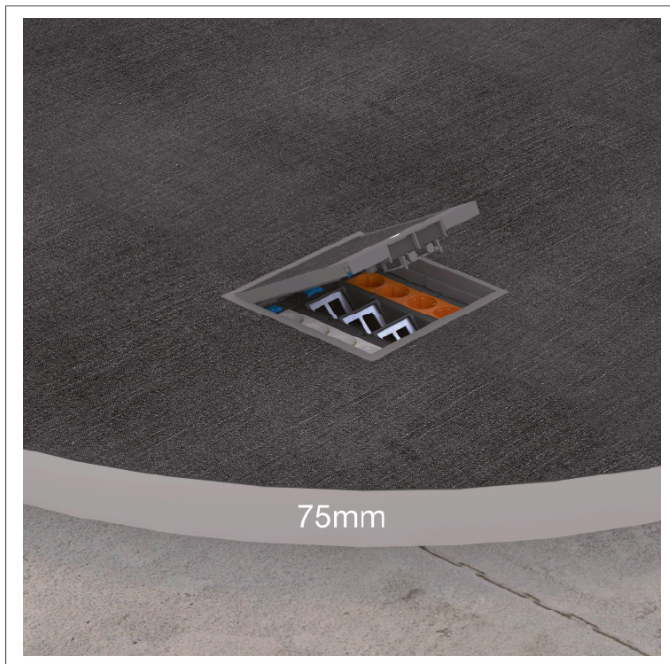

Fig. 11: Floor structure 75 mm

From a screed height of 75 mm, standard supply units with device carrier of type GTVR400, GTVR300 can be used for socket outlets or GTVD300, GTVD200 for data technology.

Here, a large selection of sizes and combination options are available.

4.3 Floor structure 105 mm

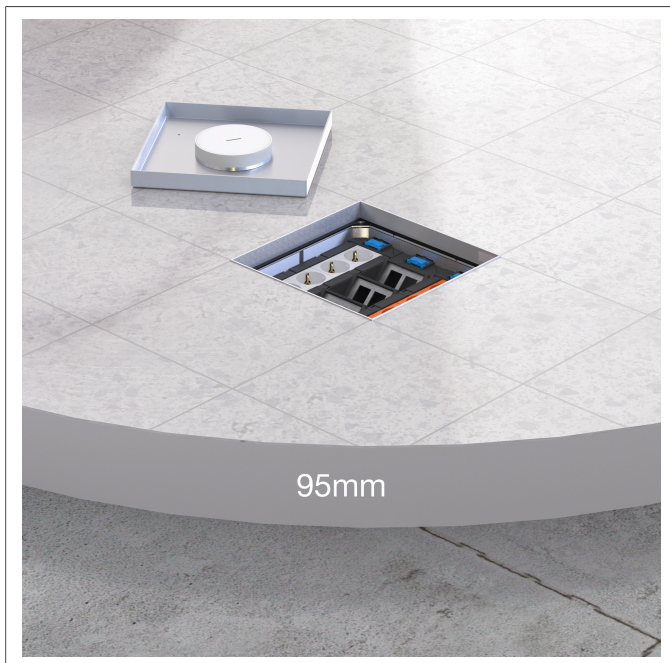

Fig. 12: Floor structure 105 mm

Stainless steel cassettes can be used with floor structure heights of 105 mm or more. The stainless steel cassettes can be equipped with the standard device carriers in the same way as the supply units.

Here too, there is a large selection of sizes and combination options. If a higher mechanical stress is required, the heavy duty variant is available in the same sizes

5 Information on the floor covering and for the floor layer

5.1 Information on the floor covering

When selecting the floor covering materials, it should be noted that floor installation systems are subject to the impacts of payloads and must be classified using testing loads of 500 N up to 20,000 N, in accordance with DIN EN 500 85.

In so doing, dynamic bending of up to 6 mm and residual deformations of up to 3 mm shall not be considered faults. Evennesses for finished floors according to DIN 18202 Tab. 3, Line 3 are to be observed.

Self-carrying layer thicknesses for facing concrete, artificial resin, mastic asphalts, as well tiles or natural stone can therefore prevent later crack formation of the covering with changing dynamic loads.

Even small bends can cause damage to thin, hard floor coverings, such as tiles. Thick floor coverings, such as granite plates, increase the load capacity of the underfloor system, producing a more beneficial load distribution.

5.2 Information for the floor layer

The floor covering, carpet, tiles, laminate, etc. to be laid must be installed correctly according to VOB Part C/DIN 18352, DIN 18353 and DIN 18365. In addition, possible trip points must be avoided using suitable measures, in accordance with the Workplaces Ordinance ArbStättV ASR A1.5/1.2 Floors of the German Federal Institute for Occupational Safety and Health.

Preconditions for laying floor coverings

Before the floor covering can be laid, the following conditions must be fulfilled:

- Dust and dirt must be removed from the floor ducts and universal floor boxes, in order to improve the adhesion of the floor coverings.
- Coverings made of wooden materials for covers must be treated on both sides, so that they do not warp. With single-sided adhesion, use double-sided carpet tape.
- With many wooden materials, it is wise to plan for expansion joints, which compensate for expansion and also shrinkage. These are then located, for example, along the side walls of the floor trunking and on outer frames of cassettes.
- With floor coverings, observe the course of the surface structure.
- Long-pile floor covers can get in the way when inserting the trunking upper part.

Laying floor covers on BKB / BKG ducts

When laying floor coverings on BKB and BKG trunking, particular attention must be placed to these two points:

- With hard floor coverings, such as wood or tiles, expansion joints must be planned for.
- With floor coverings that tend to fray, the edges should be sealed.

Laying floor covers on BKF(D) / BKW(D) ducts

- A covering joint cover (BKZBSA7011) is recommended for lightly fraying textile floor coverings rather than a covering joint edge. These are available in 2.4 m lengths.
- Use the cut floor covering to lay the trunking cover.
- Work hard floor coverings, such as wood or tiles, up to the inner side of the plastic profile.

- With hard floor coverings, such as wood or tiles, provision for expansion joints must always be given.
- A PVC floor covering can be welded to the covering joint edge.

Special features for cassettes with covering joint edge

- Work hard floor coverings, such as wood or tiles, up to the cassette which has already been inserted.
- Always plan for an expansion unit to the supply unit. With hard coverings, an expansion joint should also be planned in the cover flap.

6 Determining the cable volume

A key point in the selection of the correct trunking is the cable volume, i.e. the quantity of cables that must be routed in the trunking. As cables cannot usually be routed in an absolutely straight line on account of their properties (mostly sold from reels), cables can thus not be located close together and in parallel in the duct system.

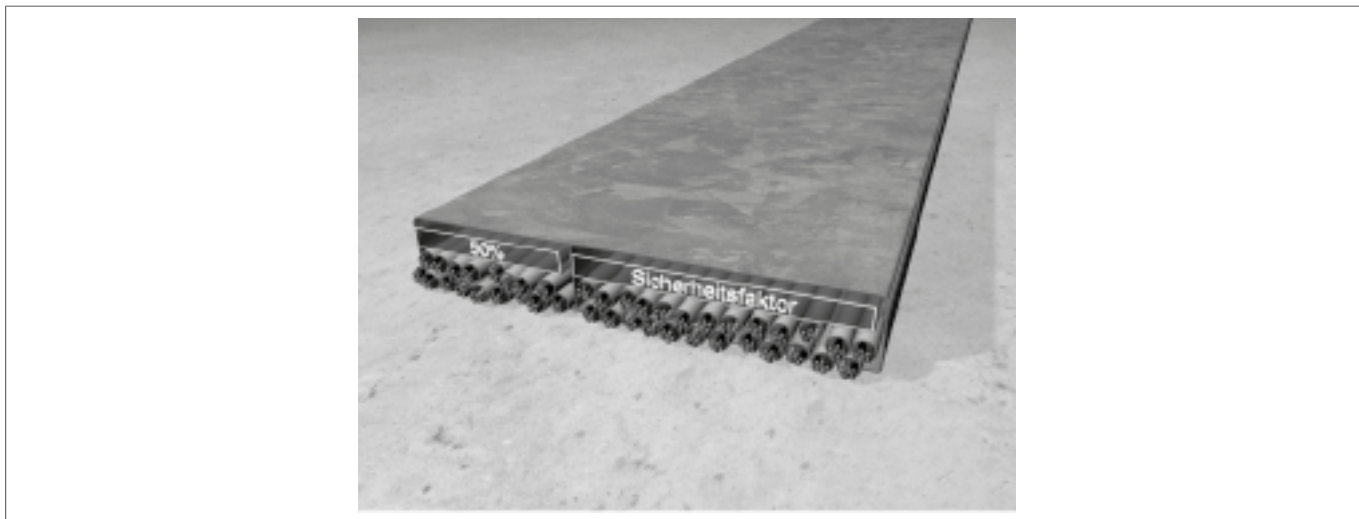

Fig. 13: Cable volume

To calculate the cable volume, not only the cable diameter must be used as a basis, but the formula $(d)^2$ must be included as a basis for calculation.

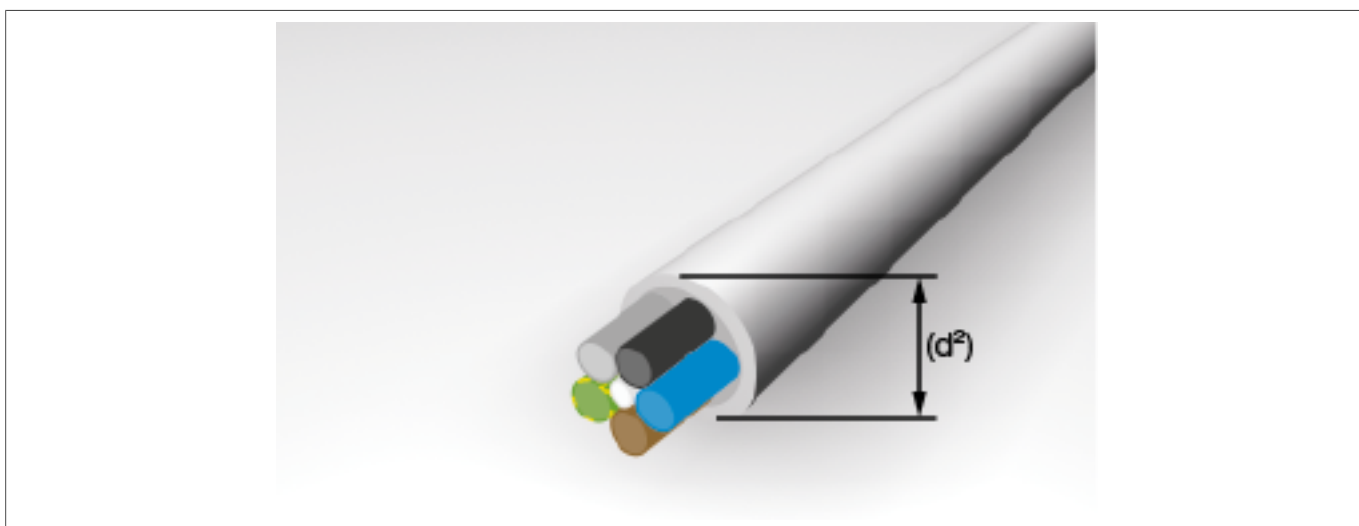

Fig. 14: Determining the cable volume

On the next page, we have listed the space requirements/duct cross-section for the most common duct types.



Note!

The listed values are average values, which can vary from manufacturer to manufacturer.

Refer to the manufacturer's data for the exact values.

Use the following table for the correct selection of the trunking size. In addition, these factors from the current DIN/VDE standards must be observed:

- Usable cross-section of the trunking
- Filling factor
- Heating up of the routed cables
- Separation of heavy and weak current
- Bend radii

Art. number	Art. designation	Width [mm]	Height min [mm]	Height max. [mm]	Trunking cross-section [cm ²] ^[1]	Max. cable assignment Ø 11 mm Filling level 0.5 ^[1]
AKU1500401	On-floor trunking base	150	40	X	60	24
BKF400105	On-floor trunking, screed-flush with the film	416	105	150	540	223
BKW200060	On-floor trunking, screed-flush with the trough	216	60	100	88	36
BKFD150065	On-floor trunking, screed-flush with the film/sealing option	170	65	110	121	50
BKWD200090	On-floor trunking, screed-flush with the trough/sealing option	220	90	130	143	59
BKBD30080	Screed-flush floor trunking with brush	300	80	X	240	70
BKGD30060	Screed-flush floor trunking, closed	300	60	X	154	61
UK340483	Underfloor trunking, 3-compartment, screed-covered	340	48	X	163	65

Table 1: Trunking size/trunking cross-section/number of cables



Note!
Further details on Table 1 can be found in the Appendix.

6.1 Bend radii

Bend radii

Bend radii are dealt with in the standard VDE 0298 (Part 3) and must be complied with when routing cables in floor installation systems.

^[1] Values are rounded

^[1] Internal levelling

6.2 Cable volume of most common installation cables

Cable volume of most common installation cables

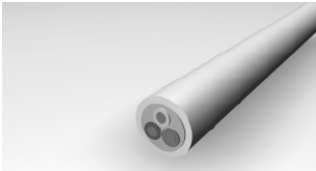

Jacketed cable, rigid

Designation	External diameter [mm]	Bending radius	Cable volume [cm ²]
NYM-J 3G1.5	8.4	4xD	0.71
NYM-J 3G2.5	9.6	4xD	0.92
NYM-J 3G4	11.3	4xD	1.28
NYM-J 3G6	12.8	4xD	1.64
NYM-J 3G10	14.7	4xD	2.16
NYM-J 3G16	19.0	4xD	3.61
NYM-J 5G1.5	10.0	4xD	1.00
NYM-J 5G2.5	12.0	4xD	1.44
NYM-J 5G4	14.0	4xD	1.96
NYM-J 5G6	15.5	4xD	2.40
NYM-J 5G10	19.5	4xD	3.80
NYM-J 5G16	23.4	4xD	5.48

Table 2: Cable volume, jacketed cable, rigid

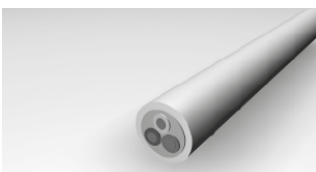

Jacketed cable, flexible

Designation	External diameter [mm]	Bending radius	Cable volume [cm ²]
H05VV-F 3G1.5	8.2	3xD	0.67
H05VV-F 3G2.5	9.8	3xD	0.96
H05VV-F 5G1.5	10.2	3xD	1.04
H05VV-F 5G2.5	13	3xD	1.69

Table 3: Cable volume, jacketed cable, flexible



Note!

The data for the external diameter and cable volume is estimates and is rounded. Refer to the manufacturer's data for exact details.

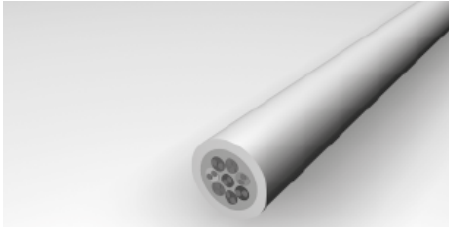

IT data cables

Designation	External diameter [mm]	Bending radius	Cable volume [cm ²]
Cat 5e - 1x4xAWG 22/7, shielded	6.5	4xD	0.42
Cat 6 - 4x2xAWG 23/1, shielded	7.4	4xD	0.55
Cat 6 - 4x2xAWG 23/1, unshielded	6.4	4xD	0.41
Cat 6a - 4x2xAWG 23/1, U/UTP	6.4	4xD	0.41
Cat 6a - 4x2xAWG 23/1, U/UTP	7.2	4xD	0.52
Cat 6a - 4x2xAWG 23/1, F/FTP	7.5	4xD	0.56
Cat 6a - 4x2xAWG 23/1, S/FTP	7.4	4xD	0.55
Cat 7a - 4x2xAWG 22/1, S/FTP	8.6	4xD	0.74
Cat 7a - 4x2xAWG 26/7 flex, S/FTP	5.8	4xD	0.34
Cat 6 - 2x(4x2xAWG 23/1), shielded	7.4 x 15.0	4xD	11.10
Cat 6 - 2x(4x2xAWG 23/1,) unshielded	6.4 x 12.8	4xD	8.19
Cat 6a - 2x(4x2xAWG 23/1), U/UTP	7.4 x 15.0	4xD	11.10
Cat 6a - 2x(4x2xAWG 23/1), F/FTP	7.5 x 15.2	4xD	11.40
Cat 6a - 2x(4x2xAWG 23/1), S/FTP	7.4 x 15.0	4xD	11.10
Cat 7a - 2x(4x2xAWG 22/1), S/FTP	8.6 x 17.5	4xD	15.05

Table 4: Cable volume, data cables

Determining the cable volume

Cable volume of most common installation cables

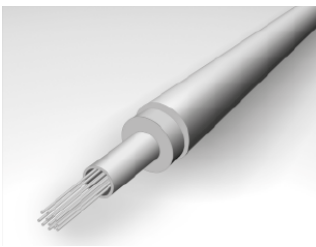

Fibre optic cables

Designation	External diameter [mm]	Bending radius	Cable volume [cm ²]
Inner cable 1x6	6.5	15xD	0.42
Inner cable 1x8	6.5	15xD	0.42
Inner cable 1x12	6.5	15xD	0.42
Inner cable 1x24	7	15xD	0.49
Inner cable 2x12	8.3	10xD	0.69
Inner cable 4x12	8.6	10xD	0.74
Inner cable 6x12	8.6	10xD	0.74
Inner cable 8x12	9.9	10xD	0.98
Inner cable 12x12	11.4	10xD	1.30
Duplex cable 2x1	5.6 x 3.2	5xD	1.79

Table 5: Cable volume, fibre optic cables



Note!

The data for the external diameter and cable volume is estimates and is rounded. Refer to the manufacturer's data for exact details.

Further details on the trunking area and cable volume can be found in the 'Appendix'.

7 Power supply and device installation units

Supply units VQ/VE/VR

The supply units are the tried-and-true solution for office installations with carpeted floors. They are available in plastic or metal. The solution is not connected to the substrate, but is clamped to the UDB floor box or directly onto the screed using the universal fastening claw.

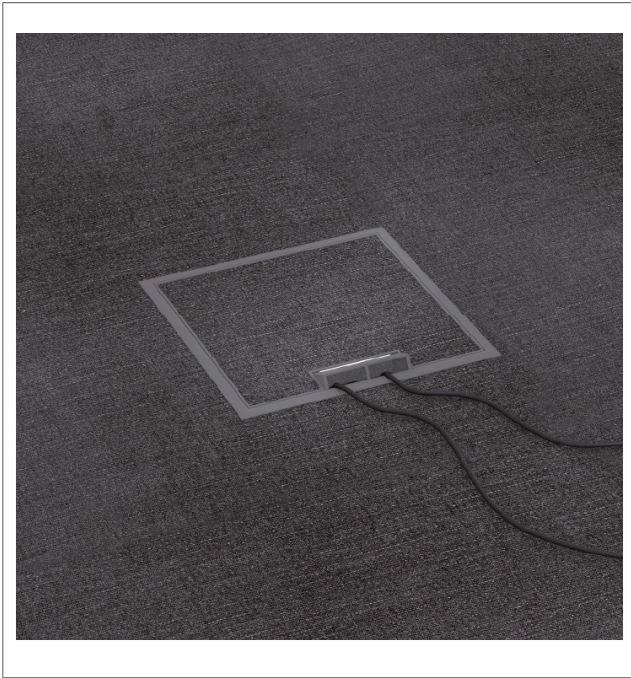

Fig. 15: VQ supply unit with carpet

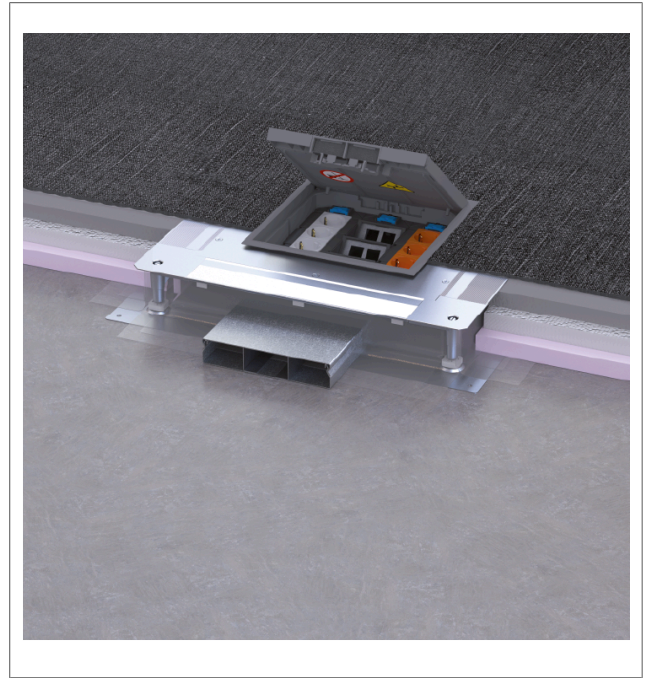

Fig. 16: VQ supply unit with carpet in cross-section

Supply units

Forms



Nominal sizes	Q12, R12, R10, E09, Q06, R06,
Number of socket outlets	12,10,9,6
Floor covering depth	5 mm, 12 mm
Design	Blank, cable outlet
Minimum installation depth	67mm, 75mm, 77mm, 85mm
Material	Plastic/stainless steel
Colours	RAL 7011, RAL 9005, stainless steel

Table 6: Overview of supply units

7.1 Stainless steel cassette EKQ/EKR/EKSQ/EKSR

The cassettes can be levelled to be flush with the height of the floor and can be completely decoupled from the socket base. Cassettes are particularly suitable for floor coverings like tiles or parquet. Various versions are available for dry/moist and wet cleaned floor coverings. The stainless steel cassettes offer continuous quality and also look attractive.

Levellable stainless steel cassettes for dry or moist cleaned floors are available in two versions. The minimum installation depth from the top edge of the finished floor is 100 mm for the blank stainless steel cassette and between 105 and 115 mm for stainless steel cassettes with device casing. The device casings can be lowered in stages down to 18 mm and a mounting device for a locking extension is possible.



Fig. 17: VE supply unit with tiles

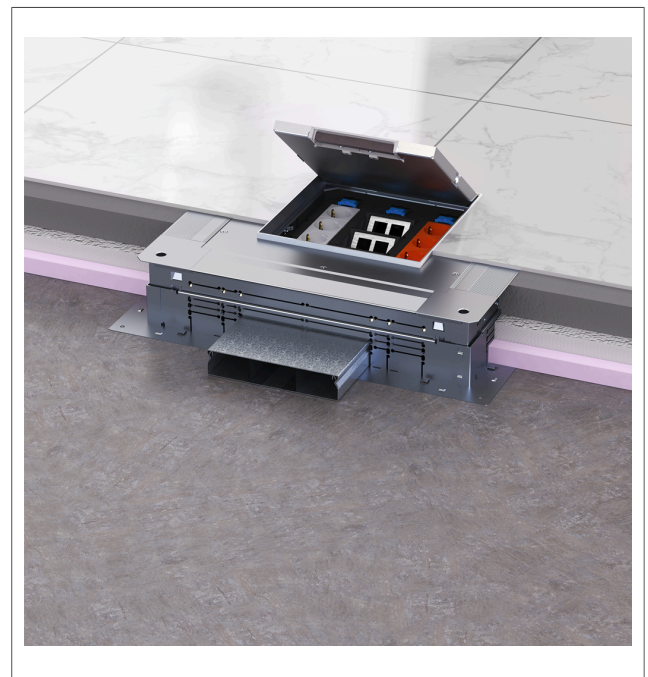

Fig. 18: VQ supply unit with tile in cross-section

Supply units



Forms	 
Nominal sizes	Q12, R12, Q06, R06
Number of socket outlets	12.6
Floor covering depth	23 mm, 38 mm
Version	Blank, cable outlet, cone
Minimum installation depth	100 mm, 105 mm, 115 mm
Material	Stainless steel

Table 7: Overview of stainless steel cassettes

Supply units

Colours	Stainless steel
---------	-----------------

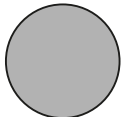
Table 7: Overview of stainless steel cassettes

Wet-cleaned supply units VANR



The VANR wet-cleaned supply units are suitable for greater mechanical stresses, such as car showrooms, and especially for floor coverings such as tiles or stone floors. The supply units are made of aluminium and are available with various cover versions.

Fig. 19: Supply unit VANR

Supply units

Forms

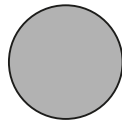

Nominal sizes	R12, R02
Number of socket outlets	12.6
Floor covering depth	3 mm, none
Version	Tube
Minimum installation depth	90 mm
Material	Aluminium
Colours	Aluminium, Aluminium/RAL9005, Aluminium/Aluminium

Table 8: Overview of wet cleaned supply units

UD floor box set UDKPQ

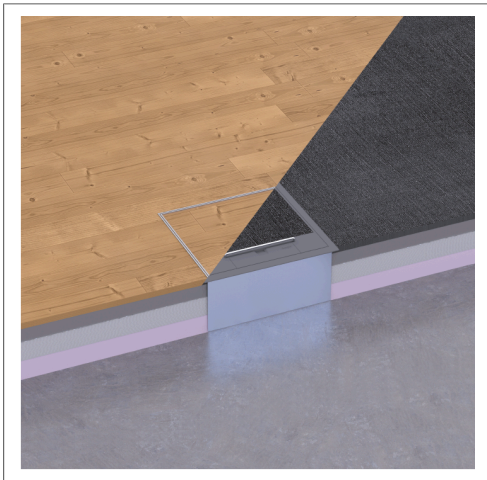

The UD floor box set series is supplied as a complete installation unit. The installation unit consists of a floor box as a screed lining and either a stainless steel cassette or supply unit for device installation. The individual elements for device installation are included in the scope of delivery. The floor box is installed directly on the raw concrete and connected with flexible installation tubes. In addition, if necessary, the floor tank can be combined individually from the individual parts and assembled on the construction site.

Fig. 20: UD floor box set UDKPQ

Supply units

Forms	
Nominal sizes	Q06
Number of socket outlets	6
Floor covering depth	5 mm, 15 mm
Design	Cable outlet
Minimum installation depth	95 mm, 100 mm
Material	Plastic/stainless steel
Colours	Stainless steel, RAL 7011, RAL 9005

Table 9: Overview, UD floor box set

Floor socket outlets BSR02



The BS floor socket outlets are particularly suitable where aesthetics, a high load capacity and versatile functionality are required.

Handling is both safe and simple: Insert the pipelines into the installation space. The installation space is closed with a cover.

The installation box of the floor socket outlets is pre-equipped with two socket outlets. Next to the socket outlets, there is space for a maximum of two connection sockets for network applications.

Fig. 21: Floor socket outlets BSR02

Supply units

Forms

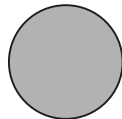

Nominal sizes	R02
Number of socket outlets	2
Floor covering depth	None
Design	Cable outlet, cone
Minimum installation depth	86 mm
Material	Plastic, die-cast zinc
Colours	Old copper, old brass, silver, RAL 7011, RAL 9005

Table 10: Overview, floor socket outlet BS

Hinged cover for flat floor mounting KDQ/KDE

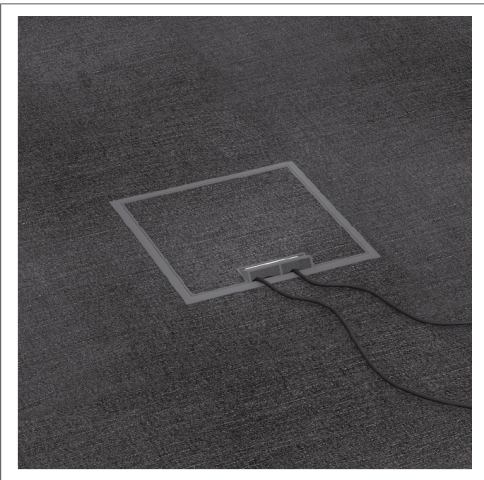

Special solutions are required for low assembling heights. The KDQ/KDE series contains hinged covers special for very flat floor mountings.

With the help of a special socket outlet GBExx, this series can allow power supplies, even with a floor mounting of 50 mm of more.

Fig. 22: Hinged cover for flat floor structure

Supply units

Forms	
Nominal sizes	Q08, E04
Number of socket outlets	8/4
Floor covering depth	5 mm, 8 mm, 12 mm
Design	Blank, cable outlet
Minimum installation depth	50 mm, 60 mm
Material	Plastic
Colours	RAL 7011, RAL 9005

Table 11: Overview, hinged cover for flat floor structure

8 IP degree of protection

The IP degree of protection of floor installation systems is tested and categorised according to EN 50085-2-2 and the type of floor care according to EN 60529. Floor installation systems are only intended for use in interior areas.

The supply unit is tested in its used and unused states to determine the degree of protection. All the duct systems and supply units must fulfil at least the IP 20 degree of protection in the used and unused states.

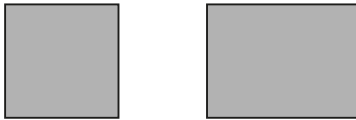
In addition to the categorisation of the IP degree of protection, with wet cleaning, it must be ensured that, in the used state, all the openings through which cables exit must be at least 10 mm above the floor surface.

The floor covering cleaning type - dry, moist, wet - is the decisive factor in the selection of the suitable supply unit.

Dry cleaning

Dry cleaned floors are primarily textile floor covers, which are cleaned by sucking up the dirt (with small amounts of liquids or completely without). Should a cleaning solution be used, then it must be dosed as low as possible, in order to prevent puddle formation or the floor covering being soaked through.

Moist cleaning

Smooth floor coverings such as linoleum, PVC, laminate, parquet or polished stone floors fulfil the requirements for moist care of the floor covering. The building cleaning trade defines this type of floor covering as a manner of binding dust with moistened or prepared cleaning textiles.

Wet cleaning

Wet cleaning is primarily used with stone coverings, tiles, ceramic floors, linoleum and PVC. This type of cleaning removes particularly tough and sticky contamination. In so doing, as much cleaning liquid is applied in the first cleaning operation with cleaning textiles as is required to soften contamination and release it. In a second operation, this liquid is wiped up again, together with the contamination, using cleaning textiles.

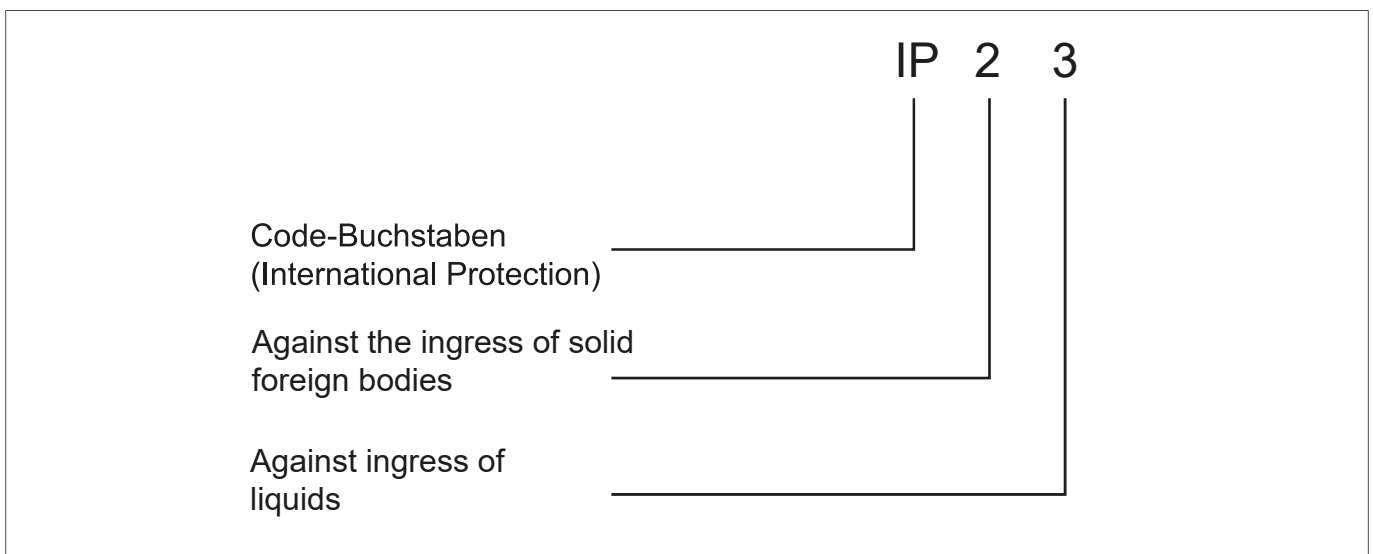

Fig. 23: Arrangement of IP code

Component	Digits or letter	Meaning for the protection of the resource	Meaning for the protection of people
Code letters	IP	-	-
First code digit		Against the ingress of solid foreign bodies	Against access to dangerous parts with
	0	Not protected	Not protected
	1	≥ 50 mm diameter	Back of the hand
	2	≥ 12.5 mm diameter	Finger
	3	≥ 2.5 mm diameter	Tool
	4	≥ 1.0 mm diameter	Wire
	5	dust-protected	Wire
	6	Dust-tight	Wire
Second code digit		Against the ingress of water with hazard impacts	
	0	Not protected	
	1	Vertical droplet	
	2	Droplet (15° incline)	
	3	Spray water	
	4	Splash water	-
	5	Water jet	
	6	Strong water jet	
	7	Temporary immersion	
	8	Continuous immersion	
	9	High pressure and high water jet temperature	

Table 12: Components of the IP code and their meaning



Further technical information on floor installation systems and their protection classes can be found in the document **6LE003421A_Schutzarten_Technische Information_de_02-24**.

The document is available in the download area on our homepage www.hager.de.

9 IK degree of impact resistance

The IK code according to (DIN) EN 50102 is a dimension for knock and impact loads. The IK code specifies the maximum mechanical load of housings of electrical resources/equipment.

10 Mechanical/thermal loads

Mechanical and thermal loads (load) are forces impacting on the floor installation duct system from outside. With improper installation and use, mechanical forces can cause deformations and destruction. Thermal forces, caused by excessive sunlight and/or heated screeds, cause the installed materials to expand. This can lead to crack formation.

Loads and their impacts on installation systems

Floor installation systems are subjected to the typical traffic loads in the building. They must withstand the mechanical stresses occurring at the place of use and, in so doing, maintain their function

The loads can be triggered by different factors:

- Being walked over by people
- Stands of office furniture
- Loads from vehicles and means of transport

The load is applied directly to the floor or the entire ceiling construction. This means that the load also has a direct influence on the installation floor installation systems.

11 Standardisation and testing

Standardisation

The EN 50085 series of standards specifies the general requirements for electrical installation duct systems. In particular, Part 2-2 describes the requirements for floor installation systems and took effect in July 2009.

The standard is divided up into two sections:

- Erector specifications
The electrical installation engineer is usually responsible for compliance with the requirements described in the erector specifications.
- Device testing specifications
The device test specifications specify the testing criteria of the products/devices. The manufacturer of the products/device is responsible for compliance with it.
Device testing specifications
 - Define the function of the product/device
 - Define the load capacity of the product/device
 - Define the area of use of the product/device
 - Are primarily responsible for the safety of the product/device (e.g. protection against electric shocks)

Classification of floor installation systems

EN 50085-1, as a general section for electrical installation trunking systems, and EN 50085-2-2, as a system-specific section for floor installation systems, prescribe a classification of the products.

This standardises product properties across Europe. For the first time, a standard for installation systems has also been given an optional load test for vertical loads that impact over a large area (heavy duty).

Classification according to EN 50085-1

6.1	Based on material
6.2	Based on impact resistance
6.3	Based on temperature
6.4	Based on resistance to flame propagation
6.5	Based on electrical conductivity
6.6	Based on electrical insulating properties
6.7	Based on degrees of protection afforded by housing/casing in accordance with EN 0529: 1991
6.8	Based on protection against corrosive or contaminated substances
6.9	Based on fastening type for system duct cover
06:10 h	Based on electrical protection separation

Classification according to EN 50085-2-2

6.101	Based on type of floor care
6.102	Based on resistance to vertical loads applied to a small area (Ø +/-13 mm)
6.103	Based on resistance to vertical loads applied to a large area (Ø +/-130 mm)

Table 13: Classification according to EN 50085

Testing

Load testing of electrical installation duct systems

Electrical installation duct systems for electrical installations must conform with the standard (DIN) EN 50085-2-2.

The standard states that electrical installation duct systems must possess sufficient mechanical stability.

Load capacity for screed-flush duct systems (BK) and their installation units

(DIN) EN 50085-2-2 defines load classes for two applications.

Tests are carried out according to:

- 6.102 with a stamp ($\varnothing 13$ mm) for standard applications (Bild, left)
- 6.103 with a plate ($\varnothing 130$ mm) for high loads (Bild, right)

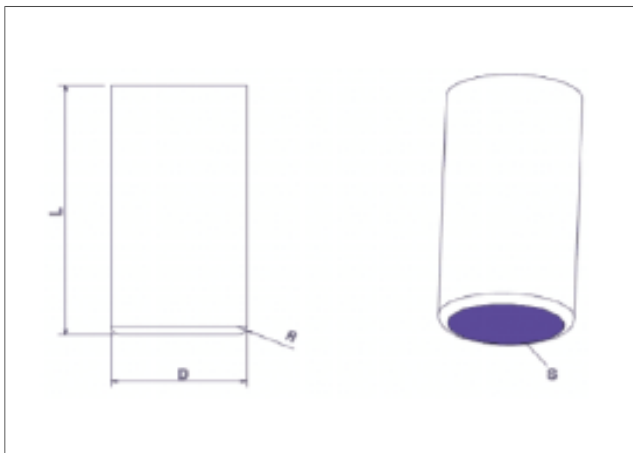

D - Diameter 13.3 ± 0.1 mm

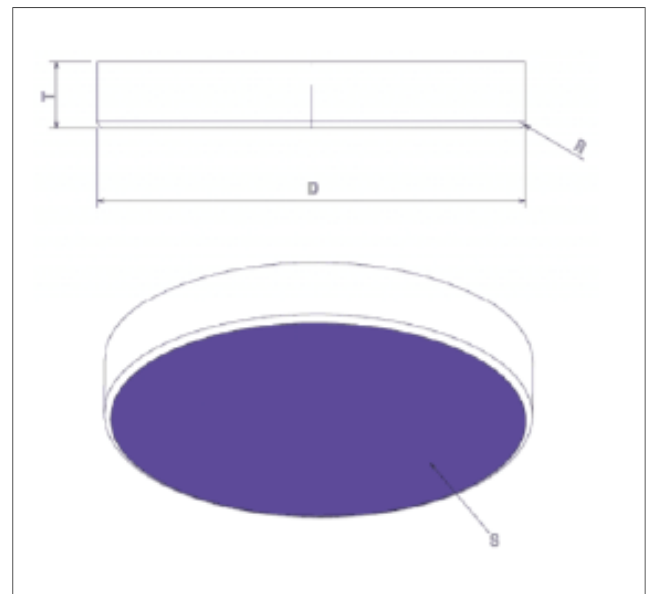

D - Diameter 130 ± 0.5 mm

Table 14: Test die (left) / test plate (right)

Testing	Load class	(DIN) EN 50085
Standard application (tested with test die Ø13 mm)	6,102.1	500 N
	6,102.2	750 N
	6,102.3	1000 N
	6,102.4	1500 N
	6,102.5	2000 N
	6,102.6	2500 N
	6,102.7	3000 N
High load (tested with a test plate Ø130 mm)	6,103.1	2000 N
	6,103.2	3000 N
	6,103.3	5000 N
	6,103.4	10000 N
	6,103.5	15000 N

Table 15: Load classes according to (DIN) EN 50085-2-2



Note!

The testing of the floor installation systems with high load requirements may be dealt with in the standard (DIN) EN 500085-2-2, but the bending during the test (6 mm) permitted in the standard and that after the test (≤ 3 mm) is not practical. Bending of this magnitude inevitably leads to damage to hard floor coverings (e.g. tiles).

Load capacity of screed-covered floor installation systems

Screed-covered duct systems are only subjected to a load during the installation phase. After this, ducts are “protected” by the screed layer and the traffic loads are distributed across the screed.

In general, it is considered that all screed-covered duct systems must be constructed in such a way so as to be stable enough to withstand the loads occurring on the construction site during storage, transport and processing.



Further technical information on floor installation systems and their protection classes can be found in the document **6LE003421A_Schutzarten_Technische Information_de_02-24**

The document is available in the download area on our homepage www.hager.de.

12 Erector specifications

The erector specifications according to DIN VDE describe a wide range of points, which the electrician must observe and comply with during the construction and installation of the floor installation systems.

The erector specifications are particularly important for:

- Safety (protection against electric shock)
- Maintenance of function - function maintenance
- Electromagnetic compatibility
- Fire protection

The following section explains some of the key points from the erector specifications:

12.1 Protection against electric shock

For the erection of a cable system with electrical installation duct systems, multiple standards from the VDE 0100 series are important, in particular:

- DIN VDE 0100-410:2018-10, which describes the protection measures for protection against electric shock, as well as
- DIN VDE 0100-520:2013-06, which describes the selection and erection of cable systems.

Electrical installation duct systems are a component part of the cable system (Section 520.3.1 in DIN VDE 0100-520) and thus of the electrical installation. They are thus not covered by Section 411.3.1.2 of DIN VDE 0100-410.

In Section 410, DIN VDE 0100-410 refers to DIN EN 61140 (VDE 0140-1), which, as a basic safety standard, describes the shared requirements for protection against electric shock for electrical systems and resources. Accordingly, the basic rule of protection against electric shock is that dangerous active parts may not be touchable and touchable, electrically conductive parts, may not become dangerous active parts, neither under normal conditions, nor under conditions of individual errors.

In addition, it describes that safety measures against electric shocks must consist of a suitable combination of two independent protective measures - of a basic protection measure and an error protection measure.

In a cable system, a basic protection measure would typically be basic insulation (e.g. wire insulation) or a protective housing.

An error protection measure is frequently the automatic switch-off of the power supply (Section 411) or double insulation (Section 412).

Table A.52.1 of DIN VDE 0100-520 defines that insulated cables (wire cables) may only be used in the electrical installation duct systems to be opened (including underfloor systems) if the duct system offers at least the protection rating IP4x and can only be opened with a tool. Jacketed cables can be used without restrictions.

In addition, Section 526.5 of DIN VDE 0100-520 defines that electrical connections must be made in suitable jacketing (e.g. boxes or in resources, if planned).

Metallic duct systems must be included in the safety measures and the equipotential bonding. This guarantees protection against electric shock according to DIN VDE 0100-410 and electromagnetic compatibility (EMC) according to EN 50310, EN 50173, EN 50174-2.

12.2 Mechanical load of cables

According to DIN VDE 0298, specific values for strain relief and bend radii may not be undershot during the routing of heavy current cables and data cables. The standard also describes the permitted types of fastenings of cables using clips and their strain reliefs.

12.3 Separation of different services

DIN VDE 0100-520 states that cables of different voltage classes may only be installed together in a routing system if all the cables have protective insulation against the highest occurring voltage. Separating webs can be used to separate the different cables, as can the guarantee of a sufficient spacing.

12.4 Fire protection

The avoidance of fires, particularly in public buildings, is the main aim of fire protection. The spread of fire and particularly of smoke into other fire sections must be prevented with all the means available for a sufficiently long period of time. This provides the opportunity to take escape, rescue and extinguishing measures.

Fire protection measures should be taken on duct systems connecting/crossing fire sections, escape and rescue routes. The directives for cable systems (M)LAR system floors (M)SysBör regulate this in more detail.

The main causes for a fire on heavy current cables are:

- Incomplete short circuits or ground faults, e.g. on mechanically or thermally damaged cables
- Incorrect electrical connections, e.g. through a loose contact
- Heat build-ups

13 Equipotential bonding

The certified floor installation system must offer the option of being included in the equipotential bonding.

All the Hager underfloor cable duct systems are constructed in such a way that the connection and inclusion in the equipotential bonding is possible without major work.

The earthing clamp BKZSAK00 is used to include the duct system in the equipotential bonding. The earthing clamp is inserted in the existing grooves and screwed tight. The terminal area is designed for a conductor cross-section of up to 4 mm².

Touchable, electrically conductive electrical installation duct systems are not included in the protective equipotential bonding (see Section 411.3.1.2 of DIN VDE 0100-410) and thus are not to be used as an error protection measure. However, they can, for example, for EMC reasons, be included in the functional equipotential bonding or in the additional protective equipotential bonding and in the lightning protection equipotential bonding.

Conversely, this means that the resources installed within the electrical installation duct system must automatically fulfil the requirements for basic protection and error protection. This also includes the cable systems according to DIN VDE 410 Section 412.2.4.

The floor installation system is an electrical installation duct system and does not fulfil the requirements for double insulation (VDE 0100-410 Section 412). This means that the use of conductors with basic protection (e.g. H07V-K) is not permitted. At least jacketed cables (e.g. NYM-J) must be used, which end or are connected in suitable jackets (e.g. in boxes or in resources). Strain relief must always be provided.

14 Inter-unit working

On today's construction sites, inter-unit working is a matter of course and the associated intensive communication with the neighbouring units essential.

For this reason, we at Hager recommend, at the beginning of the construction phase and in agreement with the construction management, co-ordination between electricians and the conterminous inter-unit working, in order to guarantee a flawless procedure for installing the floor installation system and the quality of the entire construction section.

14.1 Inter-unit working - Screed work

Screed-flush cable duct systems and the connector boxes of the screed-covered duct system are a binding draw-off gauge for the screed. The levelling height of the system components is aligned to the structural specifications of the construction management (observe the cutting check).

The screed layer must work, compact and draw off the screed carefully in the area of the connector boxes and cable trunking. Screed can be destroyed through crack formation. Screed-flush systems and system components may not be subjected to loads before the screed has finally hardened, in order to avoid crack formation in the screed.

14.2 General information for screed layers

The duct system levelled to the target screed height and the levelled floor boxes may not be subject to a load, walked on or opened before the target screed stability is reached. With covers with snap fastenings, the transport lock screws of the cover may only be removed when the screed has hardened. Screed-flush ducts and floor boxes must be levelled to the intended height before screed laying (construction side height line). The screed layer should check the levelling height. Smooth and compress screed well on the screed-flush ducts and floor boxes. Only this achieves the required load capacity. All the duct openings larger than the grain size used must be sealed.

14.3 Inter-unit working - Floor covering work

The company responsible for the floor covering work is also responsible for the exact routing and adaptation of the floor covering to the connector boxes and cable outlets.

The exact joint dimensions must be clarified in advance with the construction management.

The cover of the screed-flush connector boxes must also be covered with floor covering.

Any carpet used must be permanently laid and must be resistant to cutting.

14.4 Inter-unit working - Building cleaning

In particular during the initial cleaning of the floor surfaces, building installation units and installation spaces must be carefully cleaned of construction dust and other impurities, so that their function does not lead to impairments later.



Note!

During the use phase, building installation units must be checked for their intended use and possible damage, in order to avoid later damage (Facility Management / Electricians).

In particular, device installation units for wet cleaned floors are to be maintained regularly and the seals checked for their function. For this, it is necessary to relubricate the seal regularly (Facility Management / Electricians).

15 Sound protection and impact noise

The aim of sound protection in buildings is to prevent sound from being transferred between various rooms and/or floors. The DIN 4109 standard contains guidelines on sound and impact noise levels in residential buildings. Impact noise consists of two types of sound.

Airborne sound travels through the air, whereas structure-borne sound travels through solid bodies.

Standard DIN 4109 specifies noise limits $L_{n,w}$ that must not be exceeded in certain areas of application.

Examples of segment-related noise limits:

- Office buildings: Residential dividing ceilings and ceilings between third-party office rooms
 $L_{n,w} \leq 53$ dB
- Recreation rooms and hotels (increased sound protection requirements):
 $L_{n,w} \leq 46$ dB

The following always applies: Basic rule: The lower the values, the better the impact noise protection. The value can be reduced, for instance, by laying a floor covering (such as carpet). The transfer of impact noise can also be reduced by laying the floor on an insulation layer ('floating screed').

15.1 Impact noise reduction for floor installation systems

Reducing the transfer of impact noise is also relevant when laying underfloor installations. A testing institute was therefore engaged to measure the impact noise reduction in selected Hager products. The requested test consisted of the measurement of the vertical spread of the structure-borne sound, in other words the transmission of sound between floors.

Müller-BBM GmbH measured the impact noise reduction in the ceiling test station in accordance with the DIN EN ISO 10140 standard and evaluated the findings in accordance with the ISO 717-2 standard.

The results of the measurement of the impact noise reduction are summarised below for the floor trunking and the stainless steel cassette.

The installation of the floor trunking has no significant influence on the impact noise reduction of the screed.

The installation of the stainless steel cassette has no significant influence on the impact noise reduction of the screed.

- ▶ You can find detailed information and an evaluation of the impact noise at www.hager.de .

16 Appendix

Overview of floor installation systems - cable assignment

16.1 Overview of floor installation systems - cable assignment

Cable assignment, BKF ducts

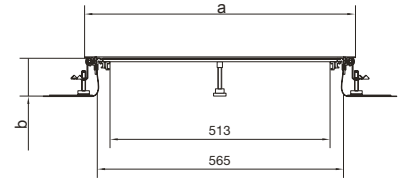

Ducts	Nominal dimension	External width a [mm]	Trunking height b max. [mm]	Height adjustment range [mm]	Usable cross-section [cm ²]	Max. cable assignment Ø11 mm Filling level 0.5
BKF200045	200	216	70	45 - 70	112	46
BKF200065	200	216	110	65 - 110	176	72
BKF200105	200	216	150	105 - 150	240	99
BKF200145	200	216	190	145 - 190	304	125
BKF300045	300	316	70	45 - 70	182	75
BKF300065	300	316	110	65 - 110	286	118
BKF300105	300	316	150	105 - 150	390	161
BKF300145	300	316	190	145 - 190	494	204
BKF400045	400	416	70	45 - 70	252	104
BKF400065	400	416	110	65 - 110	396	163
BKF400105	400	416	150	105 - 150	540	223
BKF400145	400	416	190	145 - 190	684	282
BKF500045	500	516	70	45 - 70	322	133
BKF500065	500	516	110	65 - 110	506	209
BKF500105	500	516	150	105 - 150	690	285
BKF500145	500	516	190	145 - 190	874	361
BKF600045	600	616	70	45 - 70	392	161
BKF600065	600	616	110	65 - 110	616	254
BKF600105	600	616	150	105 - 150	840	347
BKF600145	600	616	190	145 - 190	1064	439

Cable assignment, BKW ducts

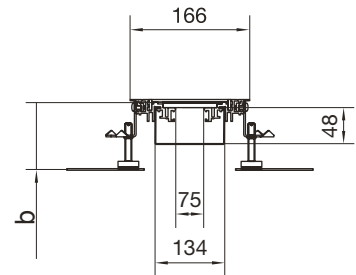

Ducts	Nominal dimension	External width a [mm]	Trunking height b max. [mm]	Height adjustment range [mm]	Usable cross-section [cm ²]	Max. cable assignment Ø11 mm Filling level 0.5
BKW200060	200	216	48	60 - 100	88.3	36
BKW200070	200	216	58	70 - 110	106.7	44
BKW200080	200	216	68	80 - 120	125.1	51
BKW200090	200	216	78	90 - 130	143.5	59
BKW300060	300	316	48	60 - 100	136.3	56
BKW300070	300	316	58	70 - 110	164.7	68
BKW300080	300	316	68	80 - 120	193.1	79
BKW300090	300	316	78	90 - 130	221.5	91
BKW400060	400	416	48	60 - 100	184.3	76
BKW400070	400	416	58	70 - 110	222.7	92
BKW400080	400	416	68	80 - 120	261.1	107
BKW400090	400	416	78	90 - 130	299.5	123
BKW500060	500	516	48	60 - 100	232.3	96
BKW500070	500	516	58	70 - 110	280.7	116
BKW500080	500	516	68	80 - 120	329.1	136
BKW500090	500	516	78	90 - 130	377.5	156
BKW600060	600	616	48	60 - 100	280.3	115
BKW600070	600	616	58	70 - 110	338.7	139
BKW600080	600	616	68	80 - 120	397.1	164
BKW600090	600	616	78	90 - 130	455.5	188

Cable assignment, BKFD ducts

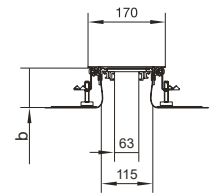

Ducts	Nominal dimension	External width a [mm]	Trunking height b max. [mm]	Height adjustment range [mm]	Usable cross-section [cm ²]	Max. cable assignment Ø11 mm Filling level 0.5
BKFD200045	200	220	70	45 - 70	112	46
BKFD200065	200	220	110	65 - 110	176	72
BKFD200105	200	220	150	105 - 150	240	99
BKFD200145	200	220	190	145 - 190	304	125
BKFD300045	300	320	70	45 - 70	182	75
BKFD300065	300	320	110	65 - 110	286	118
BKFD300105	300	320	150	105 - 150	390	161
BKFD300145	300	320	190	145 - 190	494	204
BKFD400045	400	420	70	45 - 70	252	104
BKFD400065	400	420	110	65 - 110	396	163
BKFD400105	400	420	150	105 - 150	540	223
BKFD400145	400	420	190	145 - 190	684	282
BKFD500045	500	520	70	45 - 70	322	133
BKFD500065	500	520	110	65 - 110	506	209
BKFD500105	500	520	150	105 - 150	690	285
BKFD500145	500	520	190	145 - 190	874	361
BKFD600045	600	620	70	45 - 70	392	161
BKFD600065	600	620	110	65 - 110	616	254
BKFD600105	600	620	150	105 - 150	840	347
BKFD600145	600	620	190	145 - 190	1064	439

Cable assignment, BKWD ducts

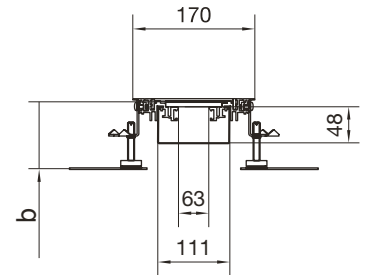

Ducts	Nominal dimension	External width [mm]	Drawing height [mm]	Height adjustment range [mm]	Usable cross-section [cm ²]	Max. cable assignment Ø11 mm Filling level 0.5
BKWD200060	200	220	48	60 - 100	88.3	36
BKWD200070	200	220	58	70 - 110	106.7	44
BKWD200080	200	220	68	80 - 120	125.1	51
BKWD200090	200	220	78	90 - 130	143.5	59
BKWD300060	300	320	48	60 - 100	136.3	56
BKWD300070	300	320	58	70 - 110	164.7	68
BKWD300080	300	320	68	80 - 120	193.1	79
BKWD300090	300	320	78	90 - 130	221.5	91
BKWD400060	400	420	48	60 - 100	184.3	76
BKWD400070	400	420	58	70 - 110	222.7	92
BKWD400080	400	420	68	80 - 120	261.1	107
BKWD400090	400	420	78	90 - 130	299.5	123
BKWD500060	500	520	48	60 - 100	232.3	96
BKWD500070	500	520	58	70 - 110	280.7	116
BKWD500080	500	520	68	80 - 120	329.1	136
BKWD500090	500	520	78	90 - 130	377.5	156
BKWD600060	600	620	48	60 - 100	280.3	115
BKWD600070	600	620	58	70 - 110	338.7	139
BKWD600080	600	620	68	80 - 120	397.1	164
BKWD600090	600	620	78	90 - 130	455.5	188

Cable assignment, BKB ducts

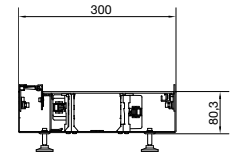

Ducts	External width [mm]	Duct height [mm]	min. trunking height incl. levelling screw [mm]	Design	Usable cross section [cm ²] without device installation	Max. cable assignment Ø11 mm Filling level 0.5 without device installation
BKBD30080	300	80.3	89	2-compartment	220	70

Table 16: BKBD30080

Cable assignment, BKG ducts

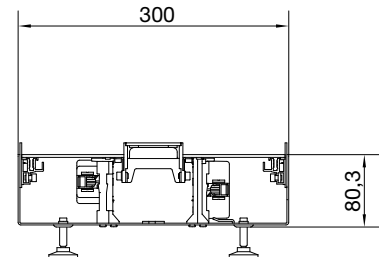

Ducts	External width [mm]	Duct height [mm]	min. trunking height incl. levelling screw [mm]	Design	Usable cross section [cm ²] without device installation	Max. cable assignment Ø11 mm Filling level 0.5 without device installation
BKGD20060	200	60.3	69	2-compartment	79	33
BKGD30060	300	60.3	69	3-compartment	123	58
BKGD40060	400	60.3	69	3-compartment	175	81
BKGD50060	500	60.3	69	4-compartment	219	104
BKGD30080	300	80.3	89	3-compartment	175	86
BKGD40080	400	80.3	89	3-compartment	248	123
BKGD50080	500	80.3	89	4-compartment	307	136

Cable assignment, UK ducts

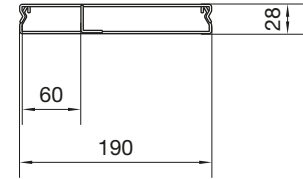

Ducts	Trunking width [mm]	Duct height [mm]	Version	Dimensions Compartments [mm]	Usable cross-section [cm ²]	Max. cable assignment Ø11 mm Filling level 0.5
UK190282	190	28	2-compartment	75/115	53.2	21 (8/13)
UK190283	190	28	3-compartment	60/70/60	53.2	20 (6/8/6)
UK190382	190	38	2-compartment	75/115	72.2	29 (11/18)
UK190383	190	38	3-compartment	60/70/60	72.2	28 (9/10/9)
UK190482	190	48	2-compartment	75/115	91.2	36 (14/22)
UK190483	190	48	3-compartment	60/70/60	91.2	35 (11/13/11)
UK240282	240	28	2-compartment	100/140	67.2	27 (11/16)
UK240283	240	28	3-compartment	85/70/85	67.2	26 (9/8/9)
UK240382	240	38	2-compartment	100/140	91.2	36 (15/21)
UK240383	240	38	3-compartment	85/70/85	91.2	36 (13/10/13)
UK240482	240	48	2-compartment	100/140	115.2	46 (19/27)
UK240483	240	48	3-compartment	85/70/85	115.2	45 (16/13/16)
UK340282	340	28	2-compartment	140/200	95.2	39 (16/23)
UK340283	340	28	3-compartment	115/110/115	95.2	38 (13/12/13)
UK340382	340	38	2-compartment	140/200	129.2	52 (21/31)
UK340383	340	38	3-compartment	115/110/115	129.2	53 (18/17/18)
UK340482	340	48	2-compartment	140/200	163.2	66 (27/39)
UK340483	340	48	3-compartment	115/110/115	163.2	65 (22/21/22)

Cable assignment, AK ducts

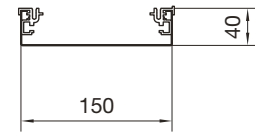

Trunking base	Duct width [mm]	Duct height [mm]	Version	Usable cross-section [cm ²]	Max. cable assignment Ø11 mm Filling level 0.5
AKU1500401	150	40	One-sided	60	24
AKU2000401	200	40	One-sided	80	33
AKU2500401	250	40	One-sided	100	41
AKU2000701	200	70	One-sided	140	57
AKU2500701	250	70	One-sided	175	72
AKU3000701	300	70	One-sided	210	86
AKU4000701	400	70	One-sided	280	115
AKU1500402	150	40	Two-sided	60	24
AKU2000402	200	40	Two-sided	80	33
AKU2500402	250	40	Two-sided	100	41
AKU2000702	200	70	Two-sided	140	57
AKU2500702	250	70	Two-sided	175	72
AKU3000702	300	70	Two-sided	210	86
AKU4000702	400	70	Two-sided	280	115

16.2 Reference sources of standards and specifications

DIN VDE Normen VDE-Verlag GmbH
Merianstrasse 29
63069 Offenbach

Beuth-Verlag GmbH
Burggrafenstrasse 4–10
10772 Berlin

VBG Vorschriften Carl-Heymanns Verlag KG
Luxemburger Strasse 449
50939 Köln

MLAR Veröffentlichung in den DIBt Mitteilungen
Deutsches Institut für Bautechnik
Kolonnenstrasse 30L
10829 Berlin

Bezug von DIBt Mitteilungen bei Verlag Ernst & Sohn
Bühningstrasse 310
13086 Berlin

VdS-Richtlinien Gesamtverband der Deutschen Versicherungswirtschaft e. V. (GDV)
Amsterdamer Strasse 174
50735 Köln



Hager Electro GmbH & Co. KG

Zum Gunterstal
66440 Blieskastel
Germany

+49 6842 945 0
+49 6842 945 4625
info@hager.com
hager.com