

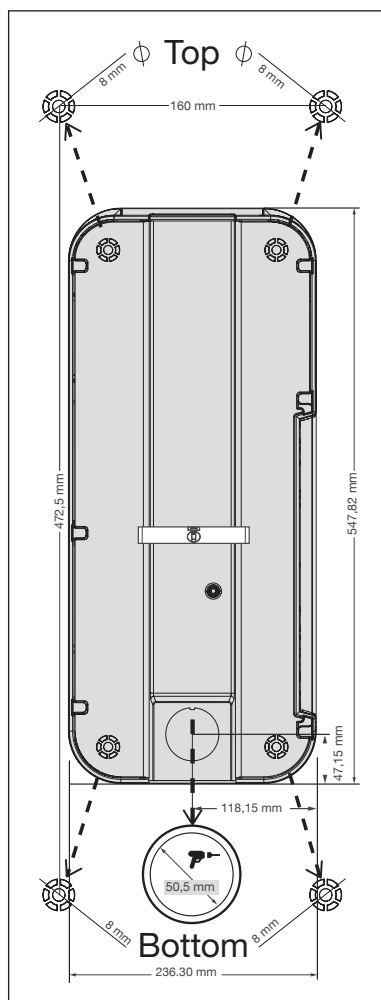

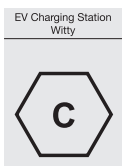

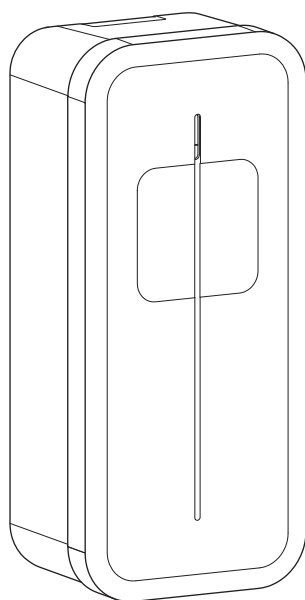

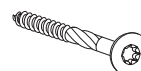

XEV1Kxx
Quick start

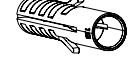

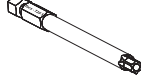
-  x 4
-  x 2
-  x 8
-  x 4
-  x 4
-  x 4
-  x 1 T25S
- 
- 
-  x 6

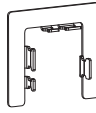

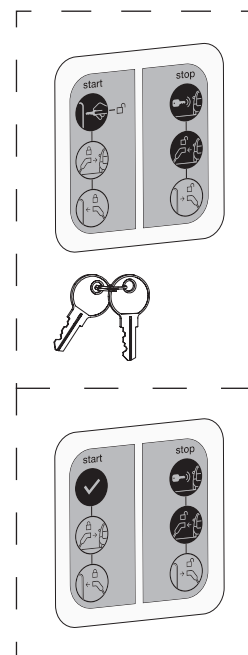
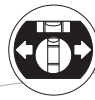
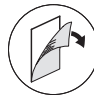
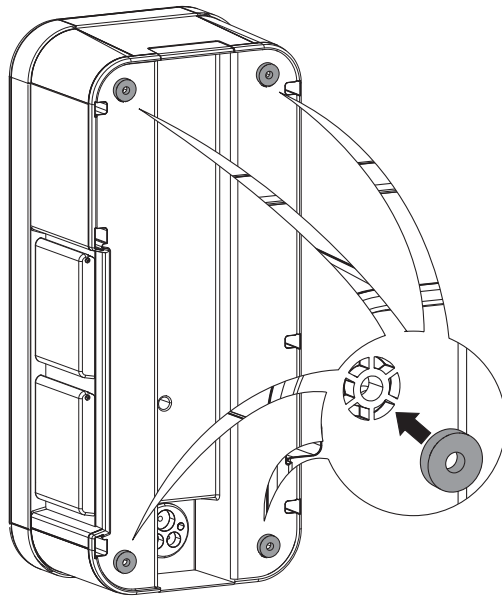
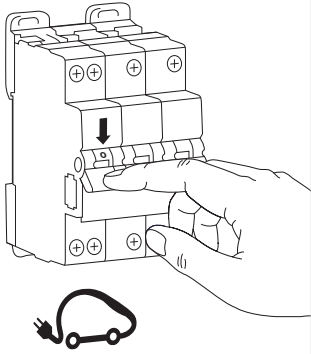
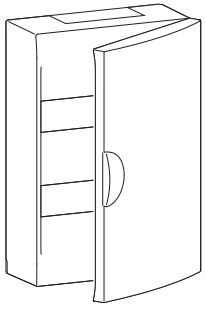

Ø 8

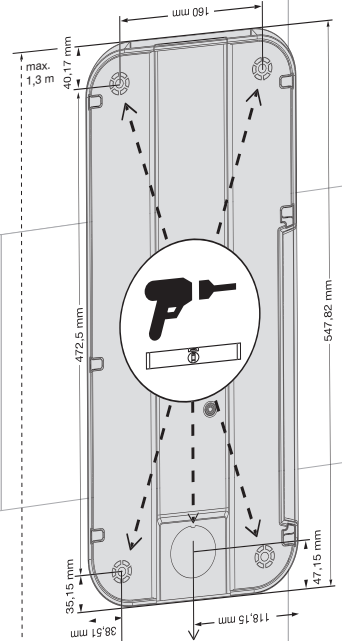

3



Torx T30

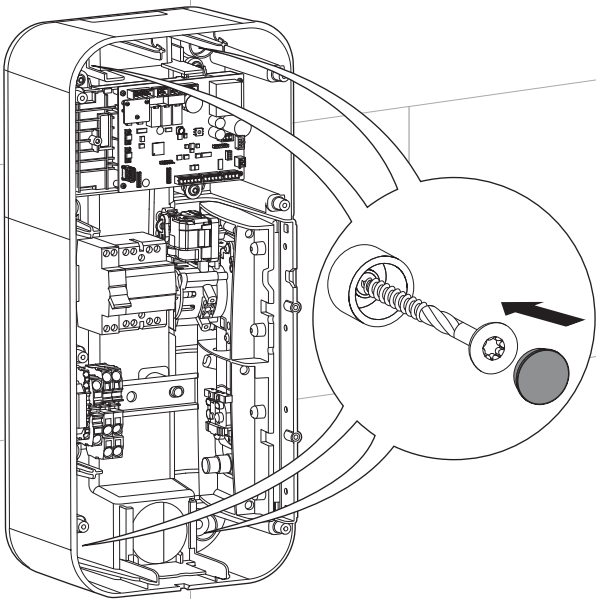

4

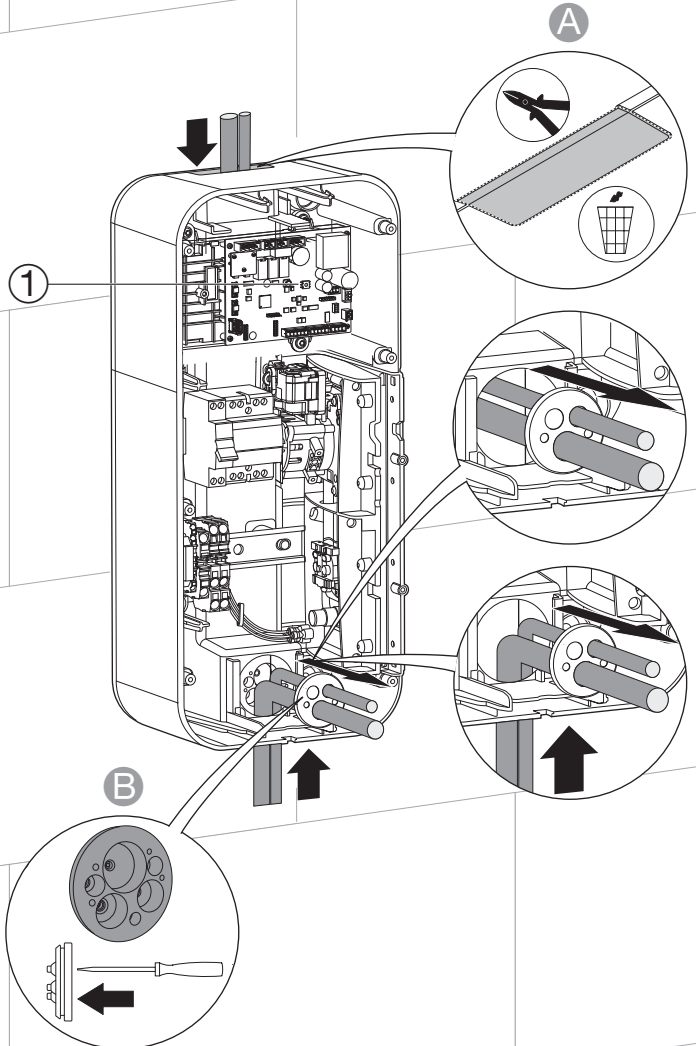

5

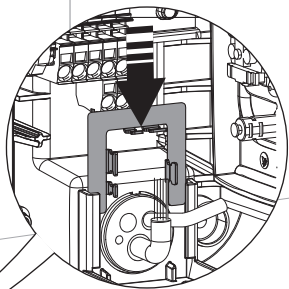
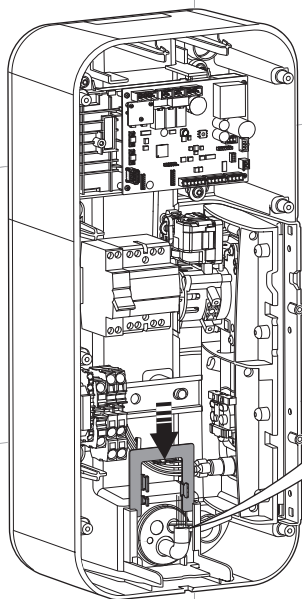

6

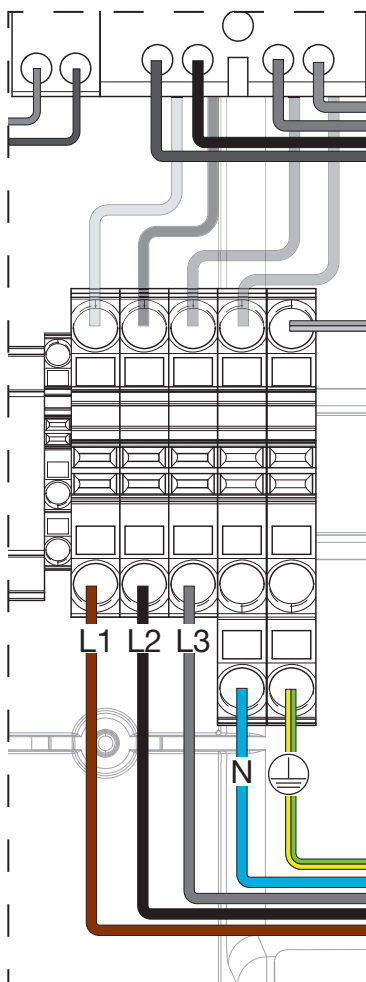
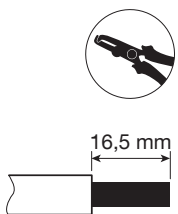
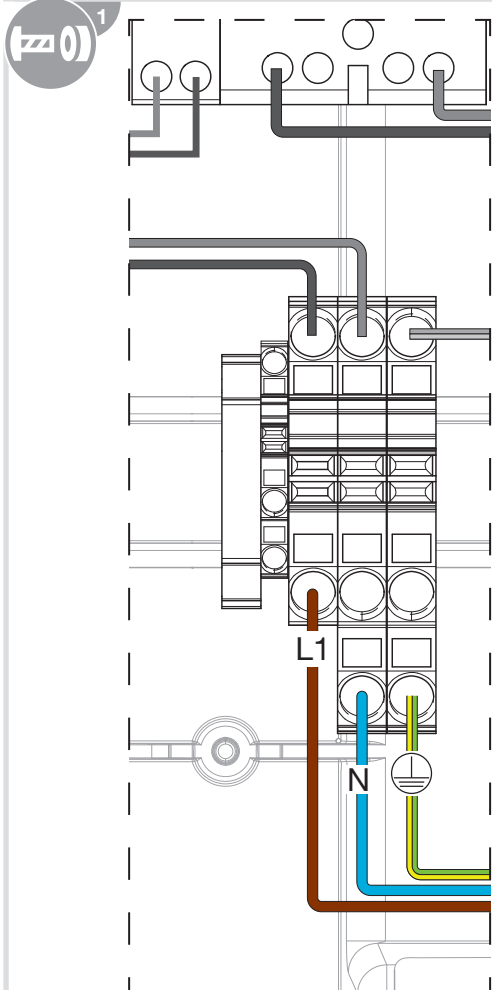
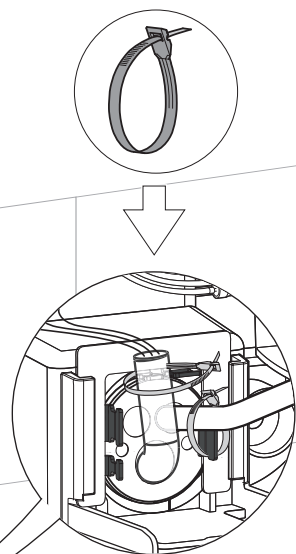
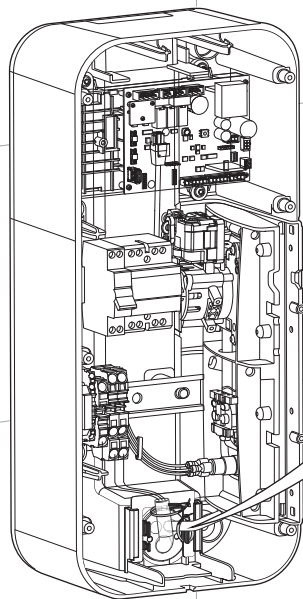

2

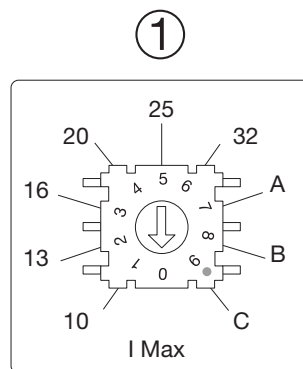

Pos.	I
0	default
1	10 A
2	13 A
3	16 A
4	20 A
5	25 A
6	32 A
7	Test A
8	Test B
9	Test C

